

CHARLOTTE
PIPE AND FOUNDRY COMPANY®

You can't beat the system.®

FlowGuard Gold®

I N S T A L L A T I O N

[Updated November 2008]

TECHNICAL MANUAL

© 2001-2008 Charlotte Pipe and Foundry Company



Aerial view of the plastics molding and extrusion plant at Monroe, North Carolina. Charlotte Pipe® operates five other extrusion facilities located in Muncy, Pennsylvania; Cameron, Texas; Wildwood, Florida; Huntsville, Alabama; and Cedar City, Utah.

Quality-tested cast iron pipe sets the standard for quiet DWV performance. Using cast iron and CPVC copper-tube-sizes provides the best solution for noise reduction in plumbing systems.



Charlotte Pipe manufactures a full line of cast iron and plastic pipe and fittings. When you specify a Charlotte® system, you can count on quality.

Introduction

When you need a dependable hot- and cold-water piping system, specify Charlotte Pipe's full line of **CPVC-CTS FLOWGUARD GOLD®** pipe and fittings. Our market research indicated that you and your customers require a potable-water system that will provide a lifetime of reliable service. We have responded with a substantial investment in both manufacturing equipment and tooling to make certain that we **meet your needs**.

Charlotte Pipe's decision to offer you these CPVC products is a natural outgrowth of our history of service to the plumbing industry. Started in 1901 as a manufacturer of cast iron soil pipe and fittings, Charlotte continues to be an industry leader in these products today. We offer a **full line** of cast iron pipe and fittings in No-Hub, Extra Heavy, and Service. Cast iron is a dynamic part of our business and the Company continues its intense focus on operating efficient, modern manufacturing facilities that produce the highest quality products.

In 1967 Charlotte Pipe formed our Plastics Division to manufacture PVC and ABS drain, waste and vent systems. By remaining responsive to customer needs, Charlotte Pipe has become the largest producer of plastic DWV pipe and fittings in the United States with production facilities in Monroe, North Carolina; Cameron, Texas; Wildwood, Florida; Muncy, Pennsylvania; Huntsville, Alabama; Cedar City, Utah. Our Industrial Division produces PVC Schedule 40 and Schedule 80 pipe and fittings, and CPVC Schedule 80 pipe and fittings. We will continue to deliver the highest quality pipe and fitting systems that can be manufactured. Our customers benefit from our full plastic pipe and fitting product range, excellent service, and a total commitment to quality.

Charlotte Pipe continues to be a privately held, strongly capitalized company that is committed to the plumbing industry. We spend millions of dollars each year to improve our manufacturing facilities, create and operate the most modern information technology, and support our people with high-quality training. As a result, Charlotte Pipe is able to provide you with a **system** of the highest quality products and the best service in the industry. We manufacture our pipe and fittings to exacting standards for a tight, reliable fit. We call it the **TrueFit System**.

What's the benefit of the Charlotte Pipe TrueFit® system? You have peace of mind knowing that the system you've purchased will fit together precisely, virtually eliminating problems caused by inferior product quality. You can rely on Charlotte to provide a wide range of high-quality TrueFit piping systems to meet your needs.

To help answer your questions about Charlotte Pipe's **CPVC-CTS FlowGuard Gold** system, this manual is arranged with a Table of Contents in the front and an easy-to-use Index in the back. If you have questions that are not answered by this manual, please call your local representative, call Charlotte Pipe at 800⁴³⁸-6091 or visit our web site at www.charlottepipe.com. Our partner in the **FlowGuard Gold** program, The Lubrizol Corporation, is also available to answer your questions at 800/331-1144.

Thank you for your confidence in Charlotte Pipe. We look forward to serving you.

TABLE OF CONTENTS	PAGE
Suggested Specification.....	5
Joints.....	6
Threaded Fittings	7
Horizontal and Vertical Support	8
CPVC Pipe Passing Through Studs.....	8
Chemical Compatibility.....	8
Special Applications.....	8
Hydronic Heating Applications.....	10
Thermal Conductivity & Sweating	10
Thermal Expansion.....	11
Expansion Loops	12
Pressure Rating vs. Temperature	13
Friction Loss and Flow Velocity for SDR 11 CTS CPVC Thermoplastic Pipe	14
Closed-Loop Systems	15
Recirculating Chilled/Hot Water Systems	15
Elevated-Temperature Performance.....	15
Low Temperature Recommendations.....	16
Cold Weather Considerations	16
Antifreeze Solutions	17
Disinfection.....	18
Under-Slab Installations.....	18
In-Slab Installations.....	18
HVAC-Condensate Drain Lines.....	18
UV Exposure.....	19
Testing of CPVC Piping.....	19
Important Product Standards and Listings	20
ASTM Standards.....	20
Listings and Code Approvals	20
Model Plumbing Code Approvals.....	21
Dimensions - Pipe and Fittings.....	22
Joining FlowGuard Gold Pipe and Fittings	23
Dimensions and Tolerances.....	24
FlowGuard Gold Copper Tube Size (CTS) CPVC SDR 11 Pipe and Fittings Fact Sheet	25
Warranty	26
Index	27

Suggested Specification

System: FlowGuard Gold® CPVC Copper Tube Size (CTS) Hot and Cold Domestic Water Distribution System

Scope: This specification covers Copper Tube Size (CTS) CPVC manufactured to standard dimensional ratio (SDR) 11 for hot and cold domestic water distribution. This system is intended for pressure applications where the operating temperature will not exceed 180°F at 100 psi.

Specification: Pipe and fittings shall be manufactured from virgin rigid CPVC (chlorinated polyvinyl chloride) vinyl compounds with a Cell Class of 24448 as identified in ASTM D 1784.

FlowGuard Gold CTS CPVC pipe and fittings shall conform to ASTM D 2846. Pipe and fittings shall be manufactured as a system and be the product of one manufacturer. All pipe and fittings shall be manufactured in the United States. Pipe and fittings shall conform to National Sanitation Foundation (NSF) Standards 14 and 61.

Installation shall comply with latest installation instructions published by Charlotte Pipe and Foundry and shall conform to all local plumbing, building and fire code requirements. Buried pipe shall be installed in accordance with ASTM F 1668. Solvent weld joints shall be made using CPVC cement conforming to ASTM F 493. Yellow one-step cement may be used without primer. If a primer is required by local plumbing or building codes, then a primer conforming to ASTM F 656 should be used. The system shall be protected from chemical agents, fire stopping materials, thread sealant, plasticized vinyl products or other aggressive chemical agents not compatible with CPVC compounds. Systems shall be hydrostatically tested after installation. Testing with compressed air or gas is not recommended. **Testing with compressed air or gas may result in injury or death.**

Referenced Standards:

ASTM D 1784	Rigid Vinyl Compounds
ASTM D 2846	CPVC Plastic Hot and Cold Water Distribution System
ASTM F 493	Solvent Cements for CPVC Pipe and Fittings
ASTM F 1668	Procedures for Buried Plastic Pipe
NSF Standard 14	Plastic Piping Components and Related Materials
NSF Standard 61	Drinking Water System Components - Health Effects

Note: Latest revision of each standard applies.

FlowGuard Gold is a registered trademark of The Lubrizol Corporation.

Short Specification:

Specification for Commercial Systems (with piping components 1/2" - 6"):

All pipe and fittings to be manufactured from CPVC compound with a cell class of 24448 for pipe and 23447 for fittings as per ASTM D 1784 and conform with National Sanitation Foundation (NSF) standards 14 and 61.

1/2" through 2" sizes: FlowGuard Gold® CPVC Copper Tube Size manufactured to standard dimension ratio (SDR) 11 and shall conform to ASTM D 2846. Transition fittings to have brass male or female connections with integral CPVC socket connections as manufactured by Charlotte Pipe and Foundry Company.

3" through 6" sizes: Corzan® CPVC Schedule 80 iron pipe size (IPS). Pipe shall conform to ASTM F 441. Socket type fittings shall conform to ASTM F 439. Transition to metal piping to be made using 150# flanged connections.

All pipe and fittings to be produced by a single manufacturer and to be installed in accordance with manufacturer's recommendations and local code requirements. Buried pipe shall be installed in accordance with ASTM F 1668. FlowGuard Gold to be joined using approved one-step solvent cement conforming to ASTM F 493. Corzan to be installed using approved solvent cement conforming to ASTM F 493 and primer conforming to ASTM F 656. Pipe and fittings to be manufactured by Charlotte Pipe and Foundry Company and are intended for hot and cold domestic water distribution systems.

Specification for Single-Family Residential Systems (with piping components 1/2" - 2"):

All pipe and fittings to be manufactured from CPVC compound with a cell class of 24448 for pipe and 23447 for fittings as per ASTM D 1784 and conform with National Sanitation Foundation (NSF) standards 14 and 61.

Pipe and fittings to be FlowGuard Gold® CPVC Copper Tube Size manufactured to standard dimension ratio (SDR) 11 and shall conform to ASTM D 2846. Transition fittings to have brass male or female connections with integral CPVC socket connections as manufactured by Charlotte Pipe and Foundry Company.

All pipe and fittings to be produced by a single manufacturer and to be installed in accordance with manufacturer's recommendations and local code requirements. Buried pipe shall be installed in accordance with ASTM F 1668. Solvent cement shall conform to ASTM F 493 and system may be installed with approved one-step cement. Pipe and fittings to be manufactured by Charlotte Pipe and Foundry Company and are intended for hot and cold water distribution systems.

The following installation tips, warnings and technical information are intended to help you install FlowGuard Gold CPVC pipe. They are not meant to be a replacement for the installation instructions, techniques and procedures which should be used in conjunction with this Manual. You are urged to read the entire Manual. **As with any pressure system, failure to follow proper installation techniques and procedures could result in property damage or personal injury. FlowGuard Gold CPVC pipe and fittings are intended for potable water distribution systems. Piping systems using CPVC pipe should be installed by licensed plumbing contractors in accordance with normal industry standards, good plumbing practices and in compliance with applicable plumbing codes, building codes and other regulations.**

JOINTS

1. Before making a CPVC joint, visually inspect pipe ends for damage and foreign materials. Burrs and filings may prevent proper contact between the pipe and fitting during assembly and should be removed from both the outside and inside of the pipe. A chamfering tool is recommended for this purpose. Chamfering may also assist in preventing a rough pipe edge from plowing cement into a fitting hub.
2. Pipe may be cut quickly and efficiently by several methods. At low temperatures a circular pipe cutter designed for plastic pipe is preferred. A ratchet cutter is another good option. **Make sure that the cutter blades are sharp. Pipe cuts must be square. Pipe ends should be free of cracks.** Chamfering may assist in identifying cracks as the chamfering tool may catch on cracks that are present.
3. When making a CPVC joint, ensure that the solvent cement conforms to ASTM F 493. It is important to use an applicator that is one-half the diameter of the pipe being joined. **Do not allow excess primer or cement to puddle in the joint assembly as this may lead to premature failure.**
4. **Use CPVC cement only.** Cement labels must be marked with ASTM F 493 and NSF designations. Never use PVC cements. All-purpose cements are unacceptable unless specifically marked as meeting the foregoing requirements. Most CTS CPVC cements are orange and light to medium-bodied. FlowGuard Gold® yellow one-step cement meeting ASTM F 493 is also available. Do not use cements older than the marked shelf life or cements that have gelled or frozen.
5. **Caution: Cements, primers and cleaners contain solvents. Use only where ventilation is proper and keep away from all sources of ignition, such as heat, sparks or open flames. Avoid skin and eye contact. In case of an accident, follow the hazardous warning and medical treatment statement on the container.**
6. Apply a light thin coat of cement inside the fitting hub. Apply an even coat of cement to the pipe end. **Too much cement can clog the pipe or weaken the pipe wall.**

7. **While inserting the pipe into the fitting socket, rotate the pipe one-quarter to one-half turn. Once the pipe end is seated, hold it in place for five to ten seconds to allow the joint to set.**
8. **Never put a fitting joint under mechanical stress, i.e., don't bend a joint.**

THREADED FITTINGS

A wide variety of male and female threaded fittings are available to transition from CPVC to valves and plumbing fixtures.

1. Do not use CPVC threaded female adapters. When joining CPVC to metallic threaded fittings, it is recommended that CPVC male threads be screwed into metallic female threads rather than metallic male threads into CPVC female threads.
2. **CPVC threaded male adapters are recommended for cold water applications only.** Please see the "Special Applications - Water Heaters" section of this technical manual for additional detail. Brass threaded transition fittings are recommended for all hot water applications.
3. Teflon tape is recommended for all threaded connections and should be a .4 minimum density, .003" thick, .50% elongation and chemically inert. To apply start with two wraps at fitting end, wrap all threads overlapping half the width of the tape in the direction of the threads on each wind.

Use of improper paste type pipe sealant may result in failure of pipe or fittings. Always verify with the manufacturer of the pipe sealant to confirm chemical compatibility with CPVC and brass components. Never use joint compound containing ammonia or chlorine on brass threaded fittings.

4. Only join to threaded components conforming to ANSI/ASME B1.20.1 or ASTM F 1498.

5. CPVC or brass threaded fittings should be hand tightened and then receive one full turn with an appropriate torque wrench. The following chart shows the correct amount of tape and torque required to make a properly functioning assembly.

Note:

- **Never use pneumatic tools for tightening.**
- **Never apply more than light pressure on a male brass or CPVC threaded fitting when clamping in a vise. Never clamp female brass transition fittings in a vise.**

Installation of Brass and CPVC Threaded Fittings			
Pipe Size	Torque Setting		Teflon Tape
	Brass Threaded Fittings	CPVC Threaded Fittings	
½"	14 ft.lbs.	3 to 5 ft.lbs.	½" width
¾"	18 ft.lbs.	4 to 6 ft.lbs.	½" width
1"	24 ft.lbs.	5 to 7 ft.lbs.	½" width
1 ¼"	30 to 60 ft.lbs.	5 to 7 ft.lbs.	1" width
1 ½"	23 to 34 ft.lbs.	6 to 8 ft.lbs.	1" width
2"	36 to 50 ft.lbs.	8 to 10 ft.lbs.	1" width

Note: 1 foot pound = 12 inch pounds

HORIZONTAL AND VERTICAL SUPPORT

Most plumbing and building codes require support for horizontal piping lines every 3 feet for pipe in ½"-1" diameters, and every 4 feet for pipe with diameters greater than 1". Support spacing should be in accordance with applicable plumbing and building codes.

Vertical CPVC piping should be properly supported and have a mid-story guide, unless thermal expansion requires another design.

The pipe should not be anchored tightly by the support, but secured in a manner to allow for movement caused by thermal expansion and contraction. It is recommended that you use clamps or straps furnished by Charlotte Pipe that allow pipe to remain away from the framing, thus reducing the noise generated when pipe is allowed to rub against wood. Use hangers and clamps that are chemically compatible with CPVC CTS FlowGuard Gold pipe and fittings.

CPVC PIPE PASSING THROUGH STUDS

Plastic insulators do not need to be used when CPVC pipe passes through wood studs.

However, when CPVC pipe passes through metal studs, some form of protection must be used to protect the pipe from abrasion and to prevent noise. Plastic insulators, rubber grommets, pipe insulation or similar devices may serve this purpose.

CHEMICAL COMPATIBILITY WITH FLOWGUARD GOLD CPVC PRODUCTS

CPVC domestic water systems have been used successfully for 40 years in new construction, repipe and repair. CPVC products are ideally suited for domestic water applications due to their corrosion resistance. Occasionally, however, CPVC can be damaged by contact with chemicals found in some construction products including thread sealant, fire stopping compounds, pipe sleeves or insulation. Reasonable care needs to be taken to ensure that products coming into contact with FlowGuard Gold CPVC systems are chemically compatible. Charlotte Pipe recommends that CPVC chemical compatibility be confirmed with the manufacturer of any product coming into contact with CPVC piping systems. If chemical compatibility with CPVC is in question, Charlotte Pipe recommends isolating the suspect product from contact with CPVC pipe or fittings.

Please call Charlotte Pipe at 800/438-6091 or visit our web site www.CharlottePipe.com for the latest FlowGuard Gold CPVC Chemical Compatibility sheet.

SPECIAL APPLICATIONS

1. Water heaters

Special considerations may be necessary when connecting CPVC pipe to a water heater. The hot water from a properly functioning water heater itself will not adversely affect the CPVC.

Instructions from the manufacturer of the water heater and applicable local plumbing and building codes should be followed.

Do not use CPVC pipe or fittings on systems capable of achieving temperatures greater than 180°F.

When CPVC pipe is used with an electric water heater, a CPVC-to-brass transition fitting should be used. CPVC threaded male adapters should not be used to connect to water heaters or connect to metallic nipples in close proximity to water heater.

When connecting to a gas water heater, CPVC should not be located within 6" of the flue or used to make the direct connection to the hot water side. A metal section of pipe and a CPVC-to-brass threaded transition fitting should be used. This reduces the potential for damage to the CPVC pipe that may result from excessive radiant heat from the flue.

CPVC can be connected to tankless gas water heaters using a CPVC-to-brass threaded transition fitting. *Verify code requirements prior to installation.*

2. Tub fillers, showerheads and outside sillcocks

CPVC should be connected to tub fillers, showerheads and outside sillcocks with a CPVC to brass threaded transition fitting or a metal nipple. Direct connection to CPVC or CPVC threaded fittings is not recommended.

3. Stub-outs for lavatories

CPVC pipe can be used for stub-outs for lavatories, closets and sinks.

4. Brass compression ferrules

CPVC pipe can be used with standard brass ferrules to make compression connections **where the operating temperature will not exceed 140°F**. The O.D. of copper tube size (CTS) CPVC pipe is identical to that of copper. We recommend that Teflon (PTFE) tape be applied over the ferrule to allow for the dissimilar thermal expansion and contraction characteristics of the metal ferrule and the plastic pipe that could possibly result in a drip leak over a period of time. **Do not over-torque the compression connection as over-torquing may result in a cracked pipe. Non-metallic or nylon ferrules are not recommended.**

HYDRONIC HEATING APPLICATIONS

The table below highlights key points to remember when installing FlowGuard Gold or Corzan CPVC in a hydronic radiant heating application. A hydronic radiant heating application is defined here as piping directly off a hot water heater or boiler into a coil heating unit in single- or multi-family homes.

"DOs" for all hydronic applications

- Install in accordance with both Charlotte Pipe and Foundry's and solvent cement manufacturer's recommendations and installation instructions.
- Follow recommended safe work practices.
- Verify that the maximum outlet temperature and pressure of the boiler is less than the temperature and pressure rating of the pipe (see charts below).
- Always use the proper derating factors with FlowGuard Gold and Corzan pipe to find the pressure rating at the applicable operating temperature.
- Always follow local codes and approvals when installing plumbing and heating equipment.
- Ensure that the system design allows for thermal expansion and contraction as recommended in the Charlotte Pipe and Foundry Plastics Technical Manual.
- Use only CPVC x brass transition fittings if using threaded connections.
- Use proper solvent cementing practices, including beveling and proper dauber sizing.
- Provide additional support to the brass side of a CPVC x brass transition or other metallic components to support the weight of the metal system.
- Use check valves, heat traps or back flow preventer to prevent cross-connections between hot and cold water lines.
- Flush the interior of heat exchangers or the exterior of condenser coils thoroughly with mild ionic detergent solution to remove incompatible oils prior to piping installation.
- Rinse with clean water to purge the system as a final flushing.
- Verify that all boiler cleaning and sealing chemicals used in the hydronic radiant heating system are compatible with CPVC.

"DON'Ts" for all hydronic applications

- **Do not** exceed the operating temperature or operating pressure of the piping system.
- **Do not** use 100% CPVC threaded adapters, male or female.
- **Do not** use the CPVC piping system to support any metallic components.
- **Do not** use compression fittings for hydronic radiant heating applications.
- **Do not** use solvent cement that exceeds its shelf life, has become discolored or has gelled.
- **Do not** use CPVC tees or other CPVC components as mixing devices.
- **Do not** over solvent-cement the joints. Puddling of solvent cement must be avoided.
- **Do not** rely on an expansion tank to handle thermal expansion of the piping system. Expansion tanks accommodate expansion of the fluid, not longitudinal expansion of the pipe. The piping system must be designed to allow for thermal expansion.

FlowGuard Gold Pressure Rating Chart (psi)

Pipe Size	73°F	80°F	120°F	140°F	180°F
ALL (SDR-11)	400	328	260	200	100

Corzan Schedule 80 Pressure Rating Chart (psi)

Pipe Size	73°F	80°F	120°F	140°F	180°F
2"	400	328	260	200	100
3"	370	303	241	185	93
4"	320	262	208	160	80
6"	280	230	182	140	70
8"	250	205	163	125	63

THERMAL CONDUCTIVITY & SWEATING

Due to its low coefficient of thermal conductivity, FlowGuard Gold® CPVC retains hot water longer and reduces condensation and sweating.

Thermal Conductivity

Thermal conductivity is defined as "transfer of heat from one part to another part of the same body, or from one body to another in physical contact with it, without appreciable displacement

of the particles of the body." This definition leads to the commonly used "K" factor, which refers to thermal conductivity. Note that the units are "Btu per hour" for one square foot of surface and "one degree Fahrenheit per inch" of material thickness.

<u>Material</u>	<u>Btu/h-Sq.Ft.-°/in</u>
CPVC	1.0
PVC	1.3
PEX	2.4
Steel	312.0
Cast Iron	360.0
Copper	2,616.0

Condensation and Sweating

Due to its low coefficient of thermal conductivity, it is often not necessary to insulate FlowGuard Gold CPVC against condensation within conditioned buildings. Two conditions that control sweating of a pipe are (1) the pipe surface temperature, which depends on the temperature of the water inside the pipe and (2) the relative humidity of the air around the pipe. Because each of the factors can vary greatly, it is possible that conditions exist that can cause CPVC pipe to sweat. Under most conditions that cause copper pipe to sweat and drip, FlowGuard Gold pipe will remain free of condensation.

THERMAL EXPANSION

The coefficient of thermal expansion for CPVC is 3.4×10^{-5} in/in/°F. Based on this, FlowGuard Gold CPVC pipe will expand about 4.1 inches per 100 feet with a 100°F temperature increase. Expansion does not vary with pipe diameter. The amount of expansion or contraction of a piping system is dependent upon the piping material's coefficient of linear expansion, the length of pipe between direction changes and the temperature differential.

The coefficient of linear expansion (Y) for CPVC pipe expressed in inches of expansion per 10°F temperature change per 100 feet of pipe is 0.408.

The length change can be calculated using the following formula:

$$\Delta L = \frac{Y (T_2 - T_1)}{10} \times \frac{L}{100}$$

Where:

ΔL = Length change, inches

Y = coefficient of linear expansion, inches/10°F/100 ft

$(T_2 - T_1)$ = temperature differential, °F

L = length of pipe run between changes in direction, feet

Example: How much expansion can be expected in a 60 foot run of 3/4" Flowguard Gold CTS CPVC installed at 70°F and operating at 140°F?

Solution: $\Delta L = \frac{0.408 (140 - 70)}{10} \times \frac{60}{100} = 0.408 \times 7 \times 0.6 = 1.71$ inches

EXPANSION LOOPS

There are several ways to compensate for expansion and contraction. The most common methods are:

1. Expansions Loops
2. Offsets
3. Change in direction

When installing the expansion loop, no rigid or restraining supports should be placed within the leg lengths of the loop. The loop should be installed as closely as possible to the mid-point between anchors. Piping support guides should restrict lateral movement and direct axial movement into the loop. Lastly, the pipe and fittings should be solvent cemented together, rather than using threaded connections.

Basic expansion loop requirements for CPVC are described below. One or more expansion loops, properly sized, may be required in a single straight run. The following charts can be used to determine expansion loop and offset lengths.

**Expansion Loop Length (L), inches
for
100°F Temperature Change
Length of Run in Feet**

Nominal Dia., In.	20'	40'	60'	80'	100'
½	16	23	28	32	36
¾	19	29	33	38	43
1	22	31	38	44	49
1¼	24	34	42	48	54
1½	26	37	45	52	59
2	30	42	52	60	67

Example: Tubing Size = 1/2" Length of run = 60' L = 28" (from table)

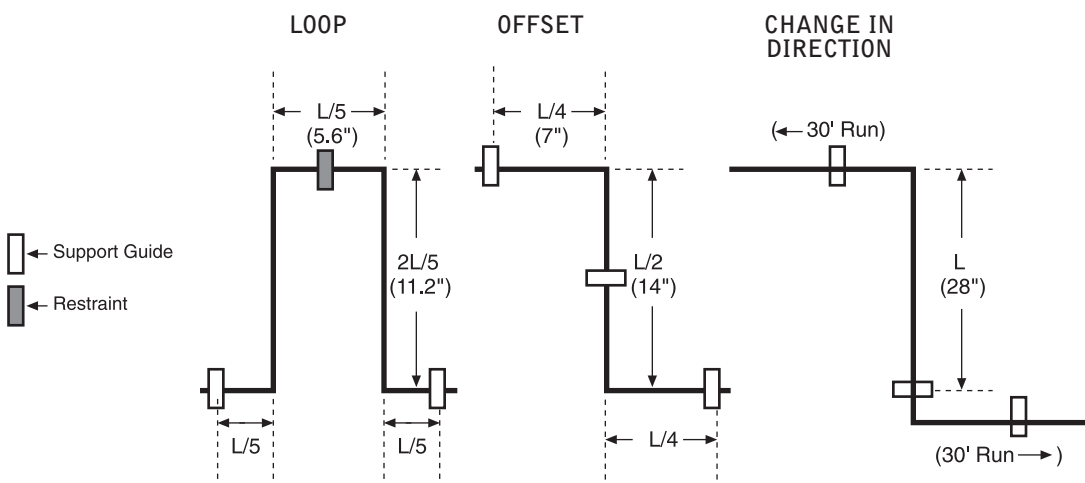

NOTE: Do not butt up against structures (e.g. joist, stud or wall).

**Pressure Rating vs. Temperature for CTS
CPVC 4120 SDR 11 Piping Systems**

Temperature °F	De-Rating Factor	Pressure Rating, PSI
73	1.00	400
80	1.00	400
90	0.91	360
100	0.82	325
120	0.65	260
140	0.50	200
160	0.40	160
180	0.25	100

Source: PPFA Bulletin No. 2-80 (10/79)

CPVC pipe is not recommended for pressure applications where temperatures will consistently exceed 180°F. The pressure de-rating factor is the same for all pipe sizes.

Example: Determine the maximum allowable operating pressure for a CTS CPVC piping system with an operating temperature of 140°F. The de-rating factor from the above chart is 0.50. Maximum allowable operating pressure = 400 x 0.50 = 200 psi.

FRICION LOSS AND FLOW VELOCITY FOR SDR 11 CTS CPVC THERMOPLASTIC PIPE

(Friction head and friction loss are per 100 feet of pipe.)

Gallons Per Minute	½ in.			¾ in.			1 in.			1¼ in.			1½ in.			2 in.		
	Velocity Feet Per Second	Head Loss Feet of Water Per 100 Ft.	Pressure Loss PSI Per 100 Ft.	Velocity Feet Per Second	Head Loss Feet of Water Per 100 Ft.	Pressure Loss PSI Per 100 Ft.	Velocity Feet Per Second	Head Loss Feet of Water Per 100 Ft.	Pressure Loss PSI Per 100 Ft.	Velocity Feet Per Second	Head Loss Feet of Water Per 100 Ft.	Pressure Loss PSI Per 100 Ft.	Velocity Feet Per Second	Head Loss Feet of Water Per 100 Ft.	Pressure Loss PSI Per 100 Ft.	Velocity Feet Per Second	Head Loss Feet of Water Per 100 Ft.	Pressure Loss PSI Per 100 Ft.
1	1.71	3.19	1.38	0.80	0.50	0.22	0.48	0.15	0.06	1.61	1.09	0.47	1.16	0.49	0.21	0.68	0.13	0.06
2	3.42	11.53	5.00	1.60	1.82	0.79	0.96	0.53	0.23	3.23	3.94	1.71	2.31	1.75	0.76	1.35	0.49	0.21
3	5.13	24.43	10.59	2.40	3.85	1.67	1.44	1.12	0.49	4.84	8.35	3.62	3.47	3.71	1.61	2.03	1.03	0.45
4	6.83	41.62	18.04	3.20	6.55	2.84	1.93	1.91	0.83	6.46	14.23	6.17	4.63	6.33	2.74	2.70	1.76	0.76
5	8.54	62.91	27.27	4.00	9.91	4.29	2.41	2.89	1.25	8.07	21.51	9.33	5.78	9.56	4.15	3.38	2.66	1.15
6	10.25	88.18	38.23	4.79	13.89	6.02	2.89	4.05	1.76	9.68	30.15	13.07	6.94	13.40	5.81	4.05	3.73	1.62
7	11.96	117.32	50.86	5.59	18.47	8.01	3.37	5.39	2.34	11.30	40.11	17.39	8.09	17.83	7.73	4.73	4.96	2.15
8	13.67	150.23	65.13	6.39	23.66	10.26	3.85	6.90	2.99	12.91	51.37	22.27	9.25	22.83	9.90	5.40	6.35	2.75
9	15.38	186.85	81.00	7.19	29.42	12.76	4.33	8.58	3.72	14.52	63.89	27.70	10.41	28.40	12.31	6.08	7.89	3.42
10	17.08	227.11	98.45	7.99	35.76	15.50	4.82	10.43	4.52	16.14	77.66	33.66	11.56	34.52	14.96	6.75	9.60	4.16
15				11.99	75.78	32.85	7.22	22.11	9.58	17.75	92.65	40.16	13.88	41.18	17.85	8.10	13.45	5.83
20				15.98	129.11	55.97	9.63	37.67	16.33	19.45	106.19	46.03	16.19	48.38	20.97	9.46	17.89	7.76
25							12.04	56.94	24.69									
30							14.45	79.82	34.60									
35							16.86	106.19	46.03									
40																		
45																		
50																		
55																		
60																		
70																		
80																		
90																		
100																		
125																		

CAUTION: Flow velocity should not exceed 5 feet per second. PVC and CPVC pipe cannot be used for compressed air service.

CLOSED-LOOP SYSTEMS

A closed-loop plumbing system is one in which water from the premises side of the water meter is unable to backflow into the main. This circumstance is becoming more and more prevalent as the result of the growing use of devices such as backflow preventers and pressure-reducing valves.

Allowance must be made in a closed system for thermal expansion. Backflow-prevention devices with built-in bypass capabilities, auxiliary pressure-relief valves or bladder-type expansion tanks are several options available to help resolve the problem and to insure long-term system performance.

Re-circulating Chilled/Hot Water Systems

CPVC may be used for many re-circulating systems including chilled and hot water hydronic heating or cooling distribution piping, pumped re-circulating domestic hot water loops, and ground water or water source heat pump distribution systems. System design pressure and temperature limitations must be observed as well as making allowances for expansion and contraction. If water treatment additives or anti-freeze are used in these systems, always confirm chemical compatibility with CPVC, brass transition fittings and other system components. Make sure that any residual oils that may be present in heat exchangers or HVAC equipment are cleaned prior to using CPVC pipe and fittings. CPVC is not recommended for use in radiant heating piping systems nor in any portion of a heat pump system where heat transfer is desired as CPVC is a natural insulator rather than a conductor of heat.

ELEVATED-TEMPERATURE PERFORMANCE (T/P RELIEF VALVE DRAINAGE PIPE)

CPVC pipe conforming to ASTM D 2846 is rated for continuous operation at 180°F/100 psi. The following addresses the expected capabilities of CPVC during short-term exposure to temperatures and/or pressures above 180°F/100 psi that may occur from time to time. **However, CPVC pipe is not recommended for pressure applications where temperatures will consistently exceed 180°F.**

1. Use of CPVC for T/P relief valve drainage lines

CPVC is a suitable material for T/P discharge piping. A CPVC-to-brass transition fitting should be used connecting to T/P relief valve.

FlowGuard Gold pipe and fittings meet the Uniform Plumbing Code short term working pressure requirement of 48 hours at 210°F/150 psi. Furthermore, CPVC pipe is approved for T/P discharge piping under the following model codes:

SBCCI	Standard Plumbing Code - Section 1210.1.
BOCA	BOCA National Plumbing Code - Section P 1506.4.2 (1991)
UPC	Uniform Plumbing Code - installation Std. IS-20 - Sec. 1007.1.
ICC	International Code Council Section 504.6.2/605.5

2. Short-term elevated pressure performance

CPVC meets the quality control provisions of the ASTM D 2846 Standard (Table 5) which requires that CPVC-CTS systems (pipe, fittings, and cemented joints) have the capability of withstanding short-term pressure tests at 180°F of at least 521 psi for 6 minutes and 364 psi for 4 hours.

LOW TEMPERATURE RECOMMENDATION

Like most materials, PVC and CPVC become more brittle at low temperatures, particularly at temperatures below freezing (32°F). Charlotte Pipe and Foundry recommends taking proper precautions when installing systems at low temperatures including providing proper insulation. If a system is designed to operate at temperatures below freezing (32°F), Charlotte Pipe recommends the following:

1. Reduce water hammer pressure surges to a minimum by:
 - a. Using only slow-acting solenoid valves, if any.
 - b. Reducing pump start-up pressure surges with slow start-up motors and rubber expansion devices.
 - c. Not exceeding maximum fluid velocity of 5-feet per second.
2. Provide more than minimum Charlotte Pipe recommended support spacing.
3. Thrust blocking at branches, changes in direction and end of runs.
4. Use expansion/contraction devices when temperature changes occur in runs.
5. Strictly follow chemical-resistance recommendations.
6. Protect piping from UV, if applicable.

COLD WEATHER CONSIDERATIONS

The following precautions are recommended in cold-weather situations.

1. **Freeze Issues**

CPVC is a ductile material, which expands and contracts more than metallic plumbing pipe. However, CPVC, like all other piping materials, needs to be protected from freezing. All model plumbing codes require that piping exposed to freezing temperatures be properly insulated.
2. **Frozen CPVC Water Lines**

Drain the system if overnight temperatures are likely to drop below 32°F. CPVC may split like other materials when water freezes in it. Immediately take action to eliminate the source of cold air causing the freezing condition, then thaw the water line if possible. If the frozen section of pipe is accessible, heated air can be blown directly onto the frozen area by using a low wattage heater/blower. Also, electrical heat tapes can be applied to the frozen area. **When thawing a frozen CPVC water line, the heat source should not exceed 180°F.**
3. **Handling**

Refrain from unnecessary abuse. Do not drop pipe from trucks, drag pipe on the ground, step on pipe or drop pipe on the ends. Inspect pipe ends for hairline cracks before making a joint. Store pipe in a heated area whenever possible.

4. **Solvent Cement**
Use the same precautions to protect CPVC solvent cement from freezing as PVC cement. Once cement gels, it cannot be recovered and should be discarded.
5. **Testing**
Cold temperature increases the necessary cure times prior to pressure testing a solvent-welded system.

ANTIFREEZE SOLUTIONS

Glycerin antifreeze solutions are recommended for use with FlowGuard Gold® and Corzan® water distribution systems.

Glycerin antifreeze should be diluted to the appropriate concentration that provides adequate freeze protection for the intended application. Maximum freeze protection for glycerin-water solutions is -51.7°F (-46.5°C) and occurs when the weight percent of glycerin is 66.7%. The effectiveness of a glycerin/water antifreeze solution diminishes above this concentration. Freeze points of glycerin-water solutions follow:

Freezing Points of Glycerin-Water Solutions (weight %)

Glycerin by weight (%)	Freeze Point °F (°C)
0	32.0 (0.0)
10	29.1 (-1.6)
20	23.4 (-4.8)
30	14.9 (-9.5)
40	4.3 (-15.4)
50	-9.4 (-23.0)
60	-30.5 (-34.7)
66.7	-51.7 (-46.5)
Greater than 66.7	Not Recommended

Propylene glycol or ethylene glycol antifreeze solutions are not recommended for use with FlowGuard Gold and Corzan water distribution systems for the following reasons:

- Solutions of glycol greater than 25% propylene or 50% ethylene are incompatible with CPVC and may cause damage to CPVC piping systems.
- Mixing solutions in dilution containers may pose the threat of contamination of the glycol solutions.
- The 25% Propylene glycol solutions that are approved for use with potable water systems only provide freeze protection to about 15°F(-10°C).
- **Ethylene glycol solutions are toxic and must therefore be avoided in potable water and food processing systems. 50% ethylene glycol solutions provide freeze protection to about -33°F (-36°C).**

DISINFECTION

CPVC has been tested and found to be unaffected by chlorine in concentrations up to 3,000 parts per million in water. Normal system disinfection at 50 ppm chlorine will not harm FlowGuard Gold systems.

UNDER-SLAB INSTALLATIONS

FlowGuard Gold® CPVC is suitable for under-slab installations when approved by prevailing plumbing and building codes.

When performing under-slab installations, it is important that the pipe be evenly supported. Charlotte Pipe recommends pressure testing with water prior to backfilling and pouring the slab. Backfill should be clean earth, sand, gravel or other approved material, which must not contain stones, boulders or other materials that may damage or break the piping. The pipe should be protected from damage by tools and equipment used to finish the concrete. Because CPVC does not react to concrete or stucco and is inert to acidic soil conditions, it does not need to be sleeved. *Note: Some code jurisdictions require sleeving at slab penetrations. Verify code requirements prior to installation.*

When performing installations under slab, care should be taken to isolate CPVC piping systems from direct contact with heavy concentrations of termiticides. Vinyl piping materials such as CPVC may be damaged by termiticides where they are injected into the annular space between the pipe wall and sleeving material trapping the termiticides against the pipe wall. Common-sense precautions will prevent installation problems.

Do not bend FlowGuard Gold 1/2" and 3/4" pipe in a bend tighter than an 18" radius; 1" pipe should not be bent in a radius tighter than 24".

Check applicable plumbing and building codes before making under-slab installations.

IN-SLAB INSTALLATIONS

CPVC is not suitable for in-slab radiant heating systems.

CPVC piping can be installed embedded in a concrete slab, because CPVC does not react to concrete or stucco and it is inert to acidic soil conditions.

HVAC-CONDENSATE DRAIN LINES

Do not use FlowGuard Gold® CPVC pipe or fittings for HVAC- or refrigerant-condensate lines. Some refrigerant systems contain oils that may damage CPVC products. In HVAC applications, some heat exchangers or condenser coils may contain residual oils from the manufacturing process which can cause cracking of CPVC. Caution should be exercised when installing CPVC in combination hot/air handling units or as condensate-drain lines from air conditioning systems. Confirm the compatibility of CPVC with residual oils prior to installation. The interior of heat exchangers or the exterior of condenser coils may be thoroughly cleaned with a detergent solution to remove incompatible oils prior to piping installation. A rinse with clean water to completely clean the system is advisable as a final flushing. Charlotte Pipe and Foundry will not accept responsibility for failure resulting from exposure to compressor oils in HVAC- or refrigerant-condensate lines.

UV EXPOSURE

PVC and CPVC pipe can suffer surface discoloration when exposed to ultraviolet (UV) radiation from sunlight. UV radiation affects PVC and CPVC when energy from the sun causes excitation of the molecular bonds in the plastic. The resulting reaction occurs only on the exposed surface of the pipe and to the extremely shallow depths of .001 to .003 inches. The effect does not continue when exposure to sunlight is terminated.

FlowGuard Gold® pipe and fittings contain stabilizers to protect against incremental UV exposure. As a result, pressure-bearing capability does not diminish with UV exposure or age.

The presence of an opaque shield between the sun and the pipe prevents UV degradation. UV radiation will not penetrate thin shields such as paint coatings or wrappings. Burial of CPVC pipe provides complete protection against UV attack.

The most common method used to protect above-ground CPVC pipe from the sun is painting with a latex (water base) paint. Preparation of the surface to be painted is very important. The pipe should be cleaned to remove moisture, dirt, and oil and wiped with a clean, dry cloth. Petroleum-based paints should not be used, since the presence of petroleum will prevent proper bonding of paint to pipe.

TESTING OF CPVC PIPING

Test CPVC systems hydrostatically in accordance with applicable plumbing and building codes. All air must be bled from the lines at the highest point before pressurizing. Failure to bleed trapped air may give faulty test results. Failure to bleed all trapped air may result in an explosion when pressurized.

Charlotte Pipe will not be responsible or liable for damages from injuries or death to persons or damage to property from air testing or for claims for labor and/or materials allegedly resulting from failure of our products, when tested or used with air or other compressed gases.

Pressure testing with water is recommended because:

- a) Evidence of a leak is readily visible.
- b) High pressure can be used safely, thus speeding-up the testing process
- c) Even a single, very small leak will register on the pressure gauge if the system is substantially free of air.
- d) Water will flush residual Volatile Organic Compounds (VOC's) left from primer and cement out of the system.

Note: Residual Volatile Organic Compounds (VOC's) can soften and distort CPVC FlowGuard Gold® piping components if not flushed by water.

Air testing is not recommended. Our concerns are as follows:

- a) **If a failure occurs during an air test, the potential exists for personal injury due to a piping system explosion.**
- b) **Leaks are more difficult to locate.**
- c) **A very small leak may not be detected, especially on large systems.**

IMPORTANT PRODUCT STANDARDS & LISTINGS

Tan copper-tube-size CPVC pipe and fittings are produced to the requirements of ASTM D 2846.

CPVC solvent cements must conform to ASTM F 493 and must carry this identification on the can labels along with the NSF mark.

Pipe and fittings for potable water applications must be marked with the NSF-pw logo (or the logo of an equivalent third party certification agency), to ensure that they meet the requirements of ANSI/NSF Standards 14 and 61. This testing ensures that drinking water carried by plastic pipe meets all U.S. EPA standards.

Model code approvals reference these standards and require product to be marked accordingly.

ASTM STANDARDS

ASTM Standards are developed by using a consensus process, and they are updated as necessary or reapproved every five years. The following are the ASTM standards pertinent to CPVC.

CPVC Related ASTM Standards*	
<u>Standard</u>	<u>Topic</u>
D 2846	CPVC Hot- and Cold-Water Distribution Systems
F 493	CPVC Solvent Cement Specification
F 402	Safe Handling of Solvent Cements, Primers & Cleaners
F 437	Threaded CPVC Schedule 80 Fittings
F 438	Socket CPVC Schedule 40 Fittings
F 439	Socket CPVC Schedule 80 Fittings
F 441	CPVC Schedule 40 & 80 Pipe

* Latest revision of each standard applies.

LISTINGS AND CODE APPROVALS FOR FLOWGUARD GOLD CPVC HOT- AND COLD-WATER DISTRIBUTION SYSTEMS

The following information regarding code approvals for CPVC hot- and cold-water distribution systems is provided as a service and is believed to be valid at the time of publication. **However, it should be noted that codes are subject to change, and therefore this information should not be used alone in establishing compliance. The installer or user should confirm approval and installation requirements for CPVC hot- and cold-water distribution systems from the applicable plumbing and building codes prior to installation and use.** In cities, counties and townships, jurisdiction usually lies within the local Building/Inspections Department.

The Charlotte Pipe and Foundry Company ASTM D 2846 pipe and fitting product line is regularly tested by NSF International.

LISTINGS AND CODE APPROVALS FOR FLOWGUARD GOLD® CPVC HOT- AND COLD-WATER DISTRIBUTION SYSTEMS

MODEL PLUMBING CODE APPROVALS

<u>CODE</u>	<u>ORGANIZATION HEADQUARTERS</u>
BOCA National Plumbing Code	Building Officials & Code Administrators International, Inc. 4051 W. Flossmoor Road Country Club Hills, IL 60477-5795 (312) 799-2300
National Standard Plumbing Code	National Association of Plumbing - Heating - Cooling Contractors P.O. Box 6808 Falls Church, VA 22046-1148 (703) 237-8100
Standard Plumbing Code	Southern Building Code Congress International, Inc. 900 Montclair Road Birmingham, AL 35213-1206 (205) 591-1853
Uniform Plumbing Code	International Association of Plumbing & Mechanical Officials 20001 Walnut Drive South Walnut, CA 91789-2825 (714) 595-8449
CABO 1- and 2-Family Dwelling	Council of American Building Officials 5203 Leesburg Pike, Suite 708 Falls Church, VA 22041
International Plumbing Code	International Conference of Building Officials 5360 Workman Mill Road Whittier, CA 90601 (301) 699-0541

MILITARY & GOVERNMENT SPECIFICATIONS

<u>MOST PERTINENT CODE</u>	<u>ORGANIZATION HEADQUARTERS</u>
U.S. Army Corps of Engineers (Army and Air Force)	HQ U.S. Army Corps of Engineers Engineering Division Directorate of Military Programs CEMP-EA Washington, DC 20314-1000 (202) 272-0430
Department of the Navy (Navy & Marines)	Department of the Navy Naval Facilities Engineering Command Code158D CESO NCBC Port Hueneme, CA 93043 (805) 982-5743

ASTM D 2846 DIMENSIONS AND TOLERANCES

CPVC pipe and fittings used in potable water systems are manufactured to the dimensions and specifications shown in ASTM D 2846. This product is tan in color, and the pipe has the same outside diameter as copper tubing. Pipe up through nominal 2" size is manufactured to a standard dimension ratio (SDR) of 11. The standard dimension ratio represents the ratio of the pipe O.D. to the pipe wall thickness. Consequently, all of the SDR 11 CPVC sizes have the same pressure rating.

Outside Diameters, Wall Thicknesses and Tolerances
 CPVC 4120, SDR 11 Plastic Pipe,
 in inches

Nominal Size	Average Pipe O.D.	Tolerance on Average O.D.	Wall Thickness	Tolerance on Wall
½	0.625	±0.003	0.068	+0.020
¾	0.875	±0.003	0.080	+0.020
1	1.125	±0.003	0.102	+0.020
1¼	1.375	±0.003	0.125	+0.020
1½	1.625	±0.003	0.148	+0.020
2	2.125	±0.004	0.193	+0.023

ASTM D 2846 TAPERED SOCKET DIMENSIONS AND TOLERANCES

Tapered Socket Dimensions
 CPVC 4120, SDR 11, Plastic Fittings,
 in inches

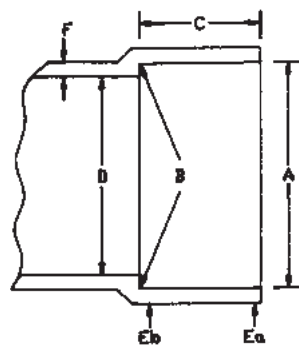

Nominal Size	Socket Entrance (A) I.D.	Socket Bottom (B) I.D.	I.D. Tolerance	(C) Min.	(D) Min.	(E _a) Min.	(E _b) Min.	(F) Min.
½	0.633	0.619	±0.003	0.500	0.489	0.068	0.102	0.128
¾	0.884	0.870	±0.003	0.700	0.715	0.080	0.102	0.128
1	1.135	1.121	±0.003	0.900	0.921	0.102	0.102	0.128
1¼	1.386	1.372	±0.003	1.100	1.125	0.125	0.125	0.156
1½	1.640	1.622	±0.004	1.300	1.329	0.148	0.148	0.185
2	2.141	2.123	±0.004	1.700	1.739	0.193	0.193	0.241

Joining FlowGuard Gold® Pipe and Fittings



1.

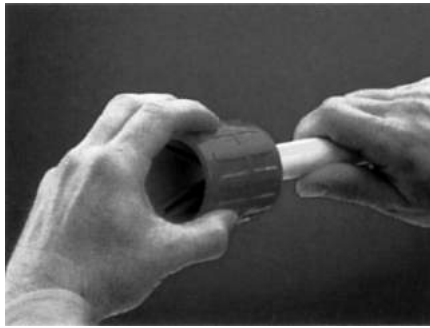

2.



3.

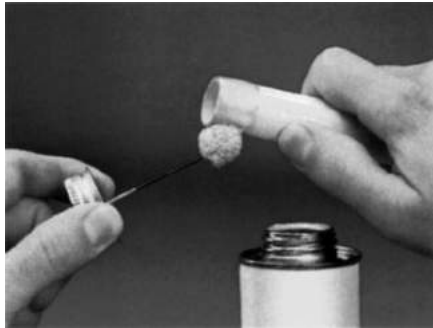

4.



5.

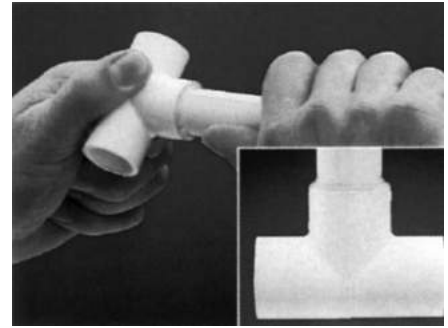

6.

1. CUTTING. FlowGuard Gold pipe can be easily cut with a wheel-type plastic pipe cutter, ratchet cutter or fine-tooth saw. Ratchet cutters should be sharpened regularly. When saw cutting, a miter box should be used to ensure a square cut. Cutting pipe as squarely as possible provides optimal bonding area within a joint. If any indication of damage or cracking is evident at the pipe end, cut off at least 2 inches beyond any visible crack.

2. DEBURRING/BEVELING. Burrs and filings can prevent proper contact between pipe and fitting during assembly and should be removed from the outside and inside of the pipe. A chamfering tool is preferred, but a pocketknife or file are also suitable for this purpose. A slight bevel on the end of the pipe will ease entry of the pipe into the fitting socket and minimize the chances of pushing solvent cement to the bottom of the joint.

3. FITTING PREPARATION. Using a clean, dry rag, wipe dirt and moisture from the fitting sockets and pipe end. Check the dry fit of the pipe and fitting. The pipe should make contact with the socket wall 1/3 to 2/3 of the way into the fitting socket. At this stage, pipe should not bottom out in the socket.

4 & 5. SOLVENT CEMENT APPLICATION. Use only CPVC cement conforming to ASTM F 493 or joint failure may occur. Yellow one-step cement may be used without primer. If a primer is required by local plumbing codes, a primer conforming to ASTM F 656 should be used. When making a joint, apply a full even layer of cement on the pipe O.D. for a distance slightly greater than the depth of the socket of the fitting. Coat the fitting socket with a medium layer of cement avoiding puddling inside the system. Apply a second full even layer of cement on the pipe O.D. Too much cement can cause clogged waterways. **Do not allow excess cement to puddle inside the fitting and pipe assembly as this may lead to premature failure.**

6. ASSEMBLY. Immediately insert the pipe into the fitting socket, rotating the pipe 1/4 to 1/2 turn while inserting. This motion ensures an even distribution of cement within the joint. Properly align the fitting. Hold the assembly for approximately 10 seconds, allowing the joint to set-up. An even bead of cement should be visible around the joint. If this bead is not continuous around the socket edge, it may indicate that insufficient cement was applied. In this case, remake the joint to avoid potential leaks. Wipe excess cement from the pipe and fittings surface for an attractive, professional appearance.

SET AND CURE TIMES. A joint which has cured sufficiently to pressure test may not exhibit its full joint strength. Solvent cement set and cure times are a function of pipe size, temperature and relative humidity. Curing time is shorter for drier environments, smaller sizes and higher temperatures. Refer to the following table for minimum cure times after the last joint has been made up before pressure testing can begin. Use of primer and/or the presence of hot water extends cure time required for pressure testing.

MINIMUM CURE PRIOR TO PRESSURE TESTING AT 100 PSI

Pipe	Ambient Temperature During Cure Period			
	60°F	40°F	32°F	0°F
1/2"	10 min.	10 min.	15 min.	30 min.
3/4"	10	15	15	30
1"	10	15	20	30
1-1/4"	10	15	20	30
1-1/2"	15	15	30	45
2"	15	15	30	60

Special care should be exercised when assembling FlowGuard Gold systems in extremely low temperatures (below 40°F) or extremely high temperatures (above 100°F). In extremely hot temperatures, make sure both surfaces to be joined are still wet with cement when putting them together.

TESTING. Once an installation is completed and cured per these recommendations, the systems should be hydrostatically pressure tested in accordance with local code requirements. When pressure testing, the system should be filled with water and all air bled from the highest and farthest points in the run. If a leak is found, the joint must be cut out and discarded. A new section can be installed using couplings. During sub-freezing temperatures, water should be blown out of the lines after testing to eliminate potential damage from freezing. **Do not test with compressed air or other gases. Charlotte Pipe will not be responsible or liable for damages from injuries or death to persons or damage to property from air testing or for claims for labor and/or materials allegedly resulting from failures of our products. By virtue of their compressibility, compressed air and other gases contain large amounts of stored energy which present a serious safety hazard should a system fail for any reason.**

ASTM D 2846
Standard Specifications
 for
FLOWGUARD GOLD®
 CPVC
PIPE AND FITTINGS
 for
HOT- AND COLD-WATER
DISTRIBUTION SYSTEMS



Nominal Size (in.)	Outside Diameter, In. (mm)		Wall Thickness, In. (mm)	
	Average	Tolerance	Minimum	Tolerance
½	0.625 (15.9)	± 0.003 (± 0.08)	0.068 (1.73)	+ 0.020 (+ 0.51)
¾	0.875 (22.2)	± 0.003 (± 0.08)	0.080 (2.03)	+ 0.020 (+ 0.51)
1	1.125 (28.6)	± 0.003 (± 0.08)	0.102 (2.59)	+ 0.020 (+ 0.51)
1¼	1.375 (34.9)	± 0.003 (± 0.08)	0.125 (3.18)	+ 0.020 (+ 0.51)
1½	1.625 (41.3)	± 0.004 (± 0.10)	0.148 (3.76)	+ 0.020 (+ 0.51)
2	2.125 (54.0)	± 0.004 (± 0.10)	0.193 (4.90)	+ 0.023 (+ 0.58)

Nominal Size (in.)	Socket Entrance Diameter, In. (mm)		Socket Bottom Diameter, In. (mm)	
	"A" Average	"A" Tolerance	"B" Average	"B" Tolerance
½	0.633 (16.08)	± 0.003 (± 0.08)	0.619 (15.72)	± 0.003 (± 0.08)
¾	0.884 (22.45)	± 0.003 (± 0.08)	0.870 (22.10)	± 0.003 (± 0.08)
1	1.135 (28.83)	± 0.003 (± 0.08)	1.121 (28.47)	± 0.003 (± 0.08)
1¼	1.386 (35.20)	± 0.003 (± 0.08)	1.372 (34.85)	± 0.003 (± 0.08)
1½	1.640 (41.66)	± 0.004 (± 0.10)	1.622 (41.20)	± 0.004 (± 0.10)
2	2.141 (54.38)	± 0.004 (± 0.10)	2.123 (53.92)	± 0.004 (± 0.10)

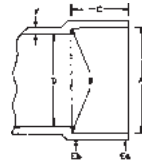

Socket Length, In. (mm) "C" min.	Inside Diameter In. (mm) "D" min.	Wall Thickness, In. (mm)		
		Socket Entrance "EA" min.	Socket Bottom "EB" min.	"F"
0.500 (12.70)	0.489 (12.42)	0.068 (1.73)	0.102 (2.59)	0.128 (3.25)
0.700 (17.78)	0.715 (18.16)	0.080 (2.03)	0.102 (2.59)	0.128 (3.25)
0.900 (22.86)	0.921 (23.39)	0.102 (2.59)	0.102 (2.59)	0.128 (3.25)
1.100 (27.94)	1.125 (28.58)	0.125 (3.18)	0.125 (3.18)	0.156 (3.96)
1.300 (33.02)	1.329 (33.76)	0.148 (3.76)	0.148 (3.76)	0.185 (4.70)
1.700 (43.18)	1.739 (44.17)	0.193 (4.90)	0.193 (4.90)	0.241 (6.12)

All information contained herein is given in good faith without guarantee of completeness or accuracy. If additional information is needed, please contact Charlotte Pipe and Foundry Company.

STORAGE

FlowGuard Gold pipe should be covered with a non-transparent material when stored outside for a long period of time.

Nominal Size (in.)	"G" min. in. (mm)	"J" min. in. (mm)	"N" min. in. (mm)
½	0.382 (9.70)	0.183 (4.65)	0.102 (2.59)
¾	0.507 (12.88)	0.235 (5.97)	0.102 (2.59)
1	0.633 (16.08)	0.287 (7.29)	0.102 (2.59)
1¼	0.758 (19.25)	0.339 (8.61)	0.102 (2.59)
1½	0.884 (22.45)	0.391 (9.93)	0.102 (2.59)
2	1.134 (28.83)	0.495 (12.57)	0.102 (2.59)

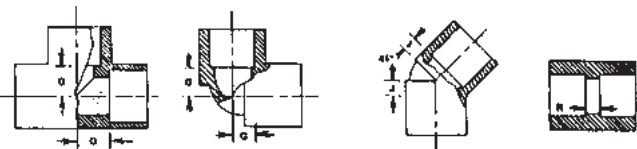

Nominal Size (in.)	Pressure Rating, PSI	
	73.4° F (23° C)	180° F (82° C)
½	400	100
¾	400	100
1	400	100
1¼	400	100
1½	400	100
2	400	100

CHARLOTTE
PIPE AND FOUNDRY COMPANY

P.O. Box 35430 • Charlotte, North Carolina 28235
 704/348-6450 • 800/438-6091 • FAX 800/553-1605
 www.charlottepipe.com

FLOWGUARD GOLD® COPPER TUBE SIZE (CTS) CPVC SDR 11 PIPE AND FITTINGS FACT SHEET

System

- FlowGuard Gold® Copper Tube Size CPVC SDR 11 Pipe and Fittings for Hot and Cold Water Systems

Standards

- ASTM D 2846 SDR 11 Pipe and Fittings
- ASTM F 493 Solvent Cement
- NSF Standard 14 Dimensional Standard
- NSF Standard 61 Health Effects

Cell Class

- 24448 (Type IV, Grade 1) CPVC 4120 per ASTM D 1784

Maximum Working Temperature

- 180 Degrees Fahrenheit

Maximum Working Pressure

- 400 PSI at 73 Degrees Fahrenheit
- 100 PSI at 180 Degrees Fahrenheit
- See De-rating Factor chart on page 23.

Joining Method

- Solvent Weld Joints
- Solvent Cement must meet ASTM F 493.
- **Where approved by code**, yellow one-step cement may be used without primer.
- All other solvent cements must be used with primer.

Cure Times

- Cure times are a function of air temperature, water temperature, humidity and pipe size. Increase the cure time for colder temperatures or higher humidity. See cure times chart on page 22.

Threaded Joint

- Threading the pipe is not recommended.
- Male adapters with plastic threads are to be used in cold water applications only.
- Only join to threaded components conforming to ANSI/ASME B1.20.1 or ASTM F 1498.
- Use Teflon tape. Teflon tape is recommended for all threaded connections and should be a .4 minimum density, .003" thick, .50% elongation and chemically inert. To apply start with two wraps at fitting end, wrap all threads overlapping half the width of the tape in the direction of the threads on each wind.

- Avoid over-tightening as this may cause damage to the thread or the fitting.
- CPVC male and female adapter fittings with brass threads are recommended.
- When combining plastic and metal threaded systems, it is recommended that plastic male threads be screwed into metal female threads rather than metal male threads into plastic female threads.

Mechanical Joints

- Brass ferrule compression ring; See Lubrizol installation guide for further details.

Thermal Expansion

- .408 inches per 10 degree temperature change per 100 foot of pipe

Special Considerations

- Do **NOT** air test.
- Consult chemical resistant chart on our web site: www.charlottepipe.com
- U.V. sensitivity; Do not install permanently in direct sunlight without painting with water-based latex paint or covering with pipe insulation.

Flame Spread and Smoke Rating for CPVC SDR 11 FlowGuard Gold

- CPVC piping systems are self extinguishing and will not support combustion. ASTM E 84 is the test protocol cited in the Uniform Mechanical Code and International Mechanical Code to determine a material's suitability for installation in a plenum area. This is essentially the same "Steiner Tunnel" test as NFPA no. 255, UL no. 723 and produces similar results. This is a full-scale burn test using 1/2" and 2" diameter pipe. The pipe was filled with water and capped on each end.
- Per ASTM E 84, CPVC in sizes 1/2" through 2", water filled, meets the 25/50 flame and smoke requirement for plenum application.
- CPVC piping systems comply with self extinguishing requirements of ASTM D 635.
- CPVC piping systems meet the V-0 burning class requirements of UL 94.
- Always follow prevailing code requirements.

CHARLOTTE

PIPE AND FOUNDRY COMPANY

FlowGuard Gold® CPVC CTS Limited Warranty

Charlotte Pipe and Foundry Company (Charlotte Pipe®) warrants to the original owner of the structure in which its FlowGuard Gold CTS CPVC Pipe and Fittings (the "Products") have been installed, that the Products will be free from manufacturing defects and conform to currently applicable ASTM standards under normal use and service for a period of ten years. Buyer's remedy for breach of this warranty is limited to replacement of, or credit for, the defective product. This warranty excludes any expense for removal or reinstallation of any defective product and any other incidental, consequential, or punitive damages. **This limited warranty is the only warranty made by seller and is expressly in lieu of all other warranties, express and implied, including any warranties of merchantability and fitness for a particular purpose.** No statement, conduct or description by Charlotte Pipe or its representative, in addition to or beyond this Limited Warranty, shall constitute a warranty. This Limited Warranty may only be modified in writing signed by an officer of Charlotte Pipe.

This Limited Warranty will not apply if:

- 1) The Products are used for purposes other than the transmission of domestic water.
- 2) The Products are not installed in good and workmanlike manner consistent with normal industry standards; installed in compliance with the latest instructions published by Charlotte Pipe and good plumbing practices; and installed in conformance with all local plumbing, fire and building code requirements.
- 3) The Products fail due to defects or deficiencies in design, engineering, or installation of the water distribution system of which they are a part.
- 4) The Products have been the subject of modification; misuse; misapplication; improper maintenance or repair; damage caused by the fault or negligence of anyone other than Charlotte Pipe; or any other act or event beyond the control of Charlotte Pipe.
- 5) The Products fail due to the freezing of water in the Products.
- 6) The Products fail due to contact with chemical agents, fire stopping materials, thread sealant, plasticized vinyl products, or other aggressive chemical agents not compatible with CPVC compounds.

The Limited Warranty will not apply to any Products for which a defect is claimed unless written notice is mailed to Charlotte Pipe at the address listed below within 30 days after the date of discovery of any such defect.

All products alleged to be defective **must** be made available to Charlotte Pipe at the following address for verification, inspection and determination of cause:

Charlotte Pipe and Foundry Company
Attention: Warranty Department
P.O. Box 35430
Charlotte, North Carolina 28235

Any product proved to be defective in manufacture will be replaced F.O.B. point of original delivery, or credit will be issued, at the discretion of Charlotte Pipe. **Purchaser must obtain written permission and/or a return goods authorization** and instructions for return shipment to Charlotte Pipe of any product claimed defective, shipped in error or excess of inventory needs.

Charlotte Pipe products are manufactured to the applicable ASTM standard. Charlotte Pipe and Foundry cannot accept responsibility for the performance, dimensional accuracy, or compatibility of pipe, fittings, gaskets, or couplings not manufactured or sold by Charlotte Pipe and Foundry.

Warning: Charlotte Pipe products are **not** to be used with compressed air or gases. Charlotte Pipe **does not recommend** that piping systems that include its products or components be tested with compressed air or compressed gases.

03/24/08

Charlotte Pipe is a registered trademark of Charlotte Pipe and Foundry Company.
FlowGuard Gold is a registered trademark of The Lubrizol Corporation.

© 2000-2008 Charlotte Pipe and Foundry Company

PO Box 35430 Charlotte, NC 28235 USA 704/348-6450 800/572-4199 FAX 800/553-1605

www.charlottepipe.com

INDEX

- ANSI/NSF Standards, 20
- Antifreeze solutions, 17
- ASTM Standards, 20, 22
- Backfill, 18
- Bend radius, min., 18
- Cement, 6, 18, 20, 23
- Chamfering, 6
- Chemical compatibility, 8
- Chlorine, 18
- Cleaners, 6
- Closed loops, 15
- Cold weather, 16
- Condensation, 10
- Cure times, 18, 23
- Cutters
 - Circular, 6
 - Ratchet, 6
- Dimensions, 22, 24
- Disinfection, 18
- Expansion loops, 12
- Hangers, 8
- Hot water heaters
 - Electric, 7, 8, 9
 - Gas, 7, 8, 9
- HVAC-condensate drain lines, 18
- Hydronic heating, 10
- Installation
 - In-slab, 18
 - Under-slab, 18
- Joining FlowGuard Gold Pipe and Fittings, 23
- Low temperature, 16
- Metal pipe connections, 7
- Metal studs, 8
- Model plumbing code approvals, 21
- NSF, 20
- Painting, 19
- Paste sealant, 7
- Pipe dope, 7
- Pipe sleeves, 18
- Plumbing codes, 20, 21
- Pressure ratings, 5, 15
- Primer, 6
- Radiant heating, 18
- Recirculating Chilled/Hot Water Systems, 15
- Relief valve (T/P drainage), 15
- Spacing, 8
- Specifications, 24
- Suggested product specifications, 5
- Support
 - Horizontal, 8
 - Vertical, 8
- Stress crack, 7
- Stub-outs, 9
- T/P discharge piping, 15
- Teflon® tape, 7
- Temperature rating, 5, 9, 11, 12, 13, 15
- Testing
 - Air, 19
 - Hydrostatic (water), 19
- Thermal expansion, 9, 11, 12, 13, 15
- Thermal conductivity, 10, 11
- Thread sealant, 7
- Threaded adapters
 - Female, 7
 - Male, 7
- Transition fittings
 - Brass/CPVC, 7, 9
- Ultraviolet exposure, 19
- Warranty, 26

To the best of our knowledge the information contained in this publication is accurate. However, Charlotte Pipe and Foundry does not assume any liability whatsoever for the accuracy or completeness of such information. Final determination of the suitability of any information or product for the use to be contemplated is the sole responsibility of the user. The manner of that use and whether there is any infringement of patents is also the sole responsibility of the user.

CHARLOTTE

PIPE AND FOUNDRY COMPANY

PO BOX 35430

CHARLOTTE

NORTH CAROLINA 28235

PHONE (704) 348-6450

(800) 438-6091

FAX (800) 553-1605

LITERATURE-BY-FAX (800) 745-9382

WWW.CHARLOTTEPIPE.COM

