

INSTALLATION INSTRUCTIONS

Pedestal Sink

American Standard

Introduction: Thank you for selecting our products...products which have been the benchmarks of fine quality for years. To help insure that the installation process will proceed smoothly, please read these instructions carefully before you begin. Also, review the recommended tools and materials list; carefully unpack and examine your new plumbing fixture.

⚠ CAUTION: PRODUCT IS FRAGILE. TO AVOID BREAKAGE AND POSSIBLE INJURY HANDLE WITH CARE!

NOTE: Pictures may not exactly define contour of china and components.

Recommended Tools & Materials

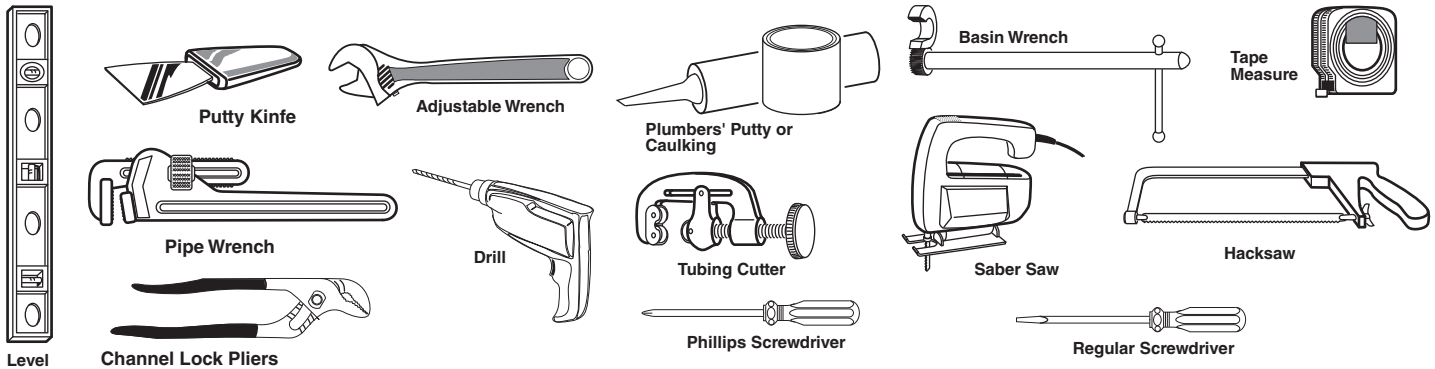

1 Provide suitable reinforcement behind finished wall for lavatory hanger mounting screws. *Determine horizontal center line location of support from fixture.

NOTE: If replacing an existing sink be certain to shut off water supply before removing old sink.

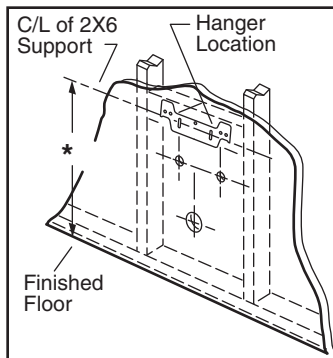

4 Remove lavatory and pedestal from installed position. Drill pilot holes for lavatory and pedestal anchor screws or lag bolts. **Note:** Some models are supplied with lag bolts, anchor screws, or steel hangers for lavatory installations only. Other models and all pedestals are not provided with mounting hardware. Various pedestal screw sizes and types are available to the installer at local hardware outlets.

2 Place lavatory and pedestal into installed position. Level and square the lavatory and pedestal assembly. Use one or more bumper cushions (supplied) to level and cushion lavatory slab to pedestal.

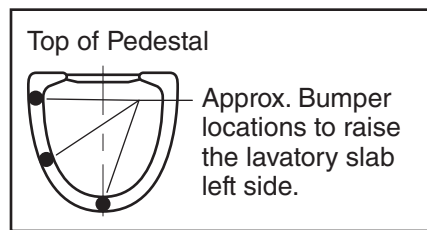

For example only

3 Mark lavatory and pedestal screw locations through the mounting holes. If a steel hanger is supplied mark the location of its screws when positioned as shown in step 5a.

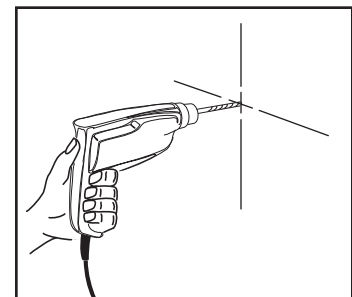

5 ANCHOR SCREW INSTALLATION

Install lavatory anchor screws leaving 1-7/8" threaded end exposed as illustrated.

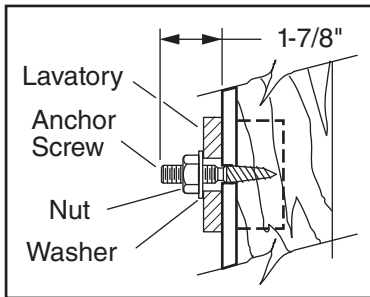

5a LAG BOLT INSTALLATION

Use lag bolts to secure lavatory as illustrated.

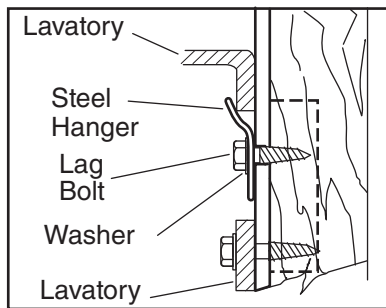

6 Following manufacturer's instructions, install faucet and drain assembly (**NOT INCLUDED - INCLUDED ONLY WITH PED TO GO PRODUCT**). Be certain to apply a bead of sealing putty on the underside of the drain (area "A") in order to ensure a watertight seal between the lavatory and drain. Remove excess putty after installing drain on lavatory.

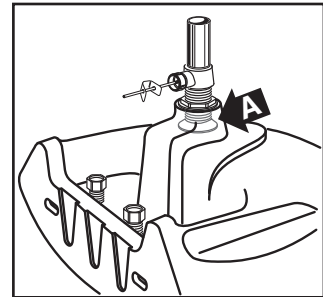

IMPORTANT: Final assembly of nut and washer or lag bolt method shown for reference only. (See steps 8 and 9).

7 Return the fitted lavatory to the installed position. Connect trap to drain assembly hand tight to check alignment. It may be necessary to cut off part of the tailpiece (area "B") or part of the horizontal leg of the trap (area "C").

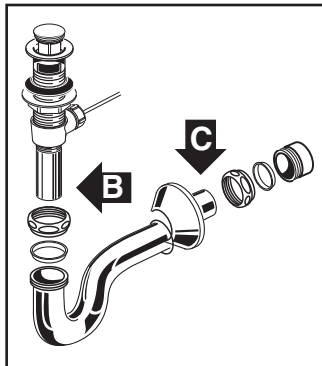

8 Secure lavatory to wall as shown in 5 or 5a. Install washers and hand tighten nuts or lag bolts. Level and square the unit. Connect hot and cold supply lines to the shut-off valves. Tighten trap joints for watertight assembly.

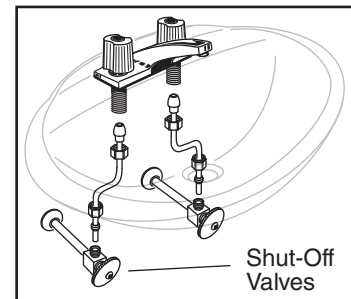

9 Install pedestal screws. Securely tighten lavatory anchor nuts or lag bolts.

Note: Space constraints may dictate method of fastening pedestal to floor.

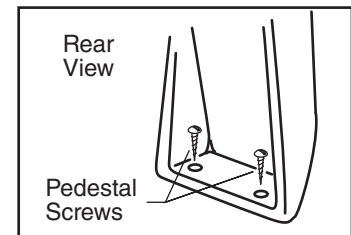

AS AMERICA, INC. ONE YEAR LIMITED WARRANTY

If inspection of this AS America, Inc. ("American Standard") plumbing product, within one year after its initial purchase, confirms that it is defective in materials or workmanship, American Standard will repair or, at its option, exchange the product for a same or similar model.

This limited warranty applies only to the original purchaser and installation of these products. In the event of a limited warranty claim, proof of purchase will be required—save sales receipts.

This limited warranty does not apply to local building code compliance. Since local building codes vary considerably, the purchaser of this product should check with a local building or plumbing contractor to insure local code compliance before installation.

This limited warranty will be void if the product has been moved from its initial place of installation; if it has been subjected to faulty maintenance, abuse, misuse, accident or other damage; if it was not installed in accordance with American Standard's instructions; or if it has been modified in a manner inconsistent with the product as shipped by American Standard.

American Standard's option to repair or exchange the product under this limited warranty does not cover any labor or other costs of removal or installation including any costs of any surrounding material such as tile or marble. American Standard is not responsible for any other incidental or consequential damages attributed to a product defect or to the repair or exchange of a defective product, all of which are expressly excluded from the warranty. This limited warranty does not cover the extension beyond the duration of this limited warranty of any implied limited warranties, including those of merchantability or fitness for an intended purpose. (Some states or provinces do not allow the exclusion or limitation of implied warranties, so this exclusion may not apply to you.)

This limited warranty gives you specific legal rights. You may have other statutory rights that vary from state to state or from province to province, in which case this limited warranty does not affect such statutory rights.

For service under this warranty, it is suggested that a claim be made through the contractor or dealer from or through whom the product was purchased, or that a service request (including a description of the product model and of the defect) be sent to the following address:

In the United States:
American Standard Brands
P.O. Box 6820
Piscataway, New Jersey 08855
Attention: Director of Consumer Affairs

For residents of the United States, warranty information may also be obtained by calling the following toll free number: (800) 442-1902
www.americanstandard-us.com

In Canada:
AS Canada, ULC
5900 Avebury Ave.
Mississauga, Ontario
Canada L5R 3M3

Toll Free: (800) 387-0369
www.americanstandard.ca

In Mexico:
Customer Service Manager
AS Maquila, S.A. de C.V.
Via Morelos #330
Col. Santa Clara
Ecatepec 55540 Edo. Mexico

www.americanstandard.com.mx

THIS WARRANTY IS NOT TRANSFERABLE FROM ORIGINAL CONSUMER PURCHASER.