

TracPipe[®]

Flexible Gas Piping by Omega Flex[®]

FLEXIBLE GAS PIPING DESIGN GUIDE and INSTALLATION INSTRUCTIONS December 2007



RESIDENTIAL • COMMERCIAL • INDUSTRIAL

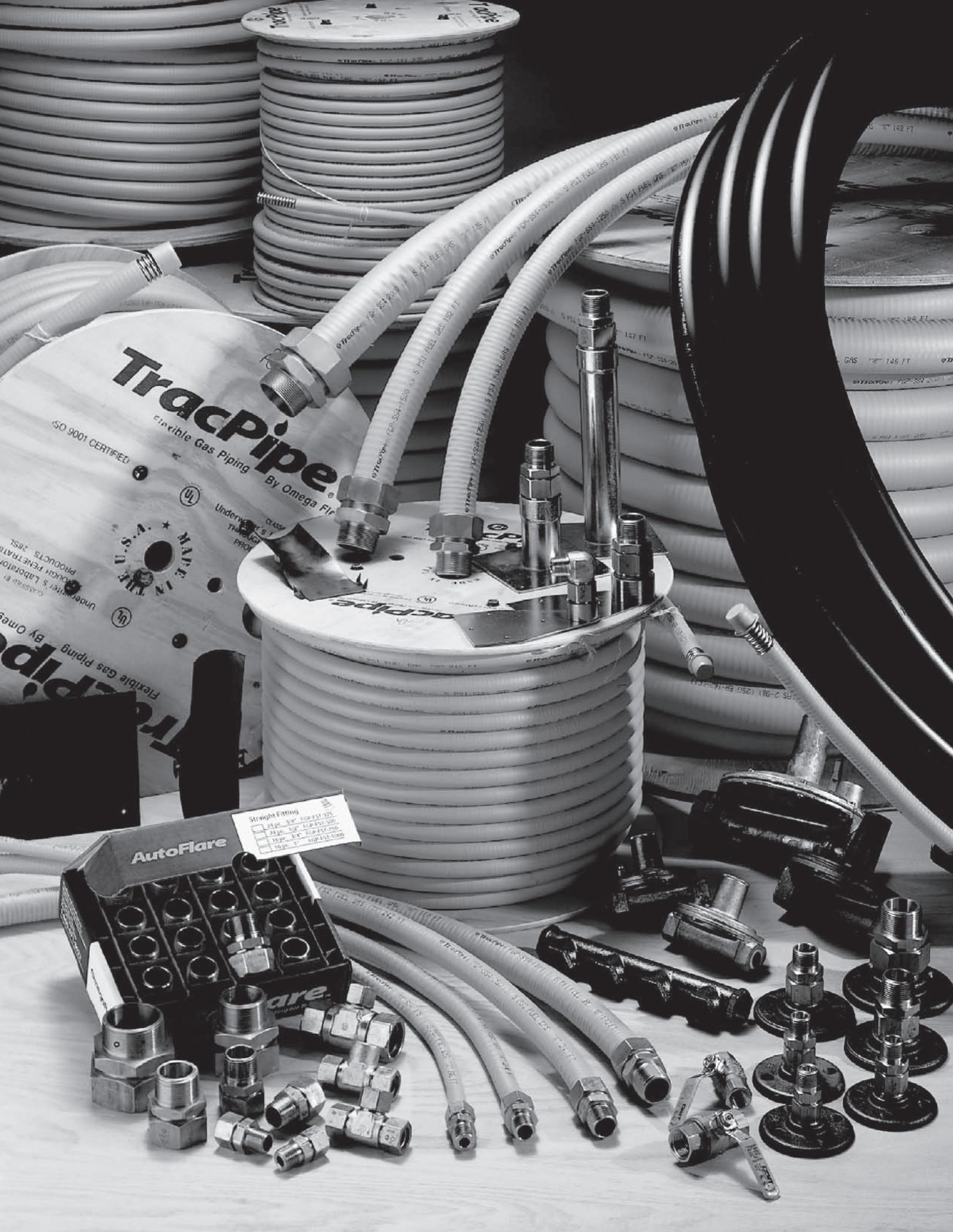

TracPipe
Flexible Gas Piping
By Omega Fire

ISO 9001 CERTIFIED



Underwriters
Laboratory
Classified
Products
28SL



TracPipe
Flexible Gas Piping
By Omega

Straight Fitting
Pipe 1/2" 100-131-175
Pipe 3/4" 100-131-176
Pipe 1" 100-131-177
Pipe 1 1/2" 100-131-178

AutoFlare

AutoFlare

5" 146 FT

TracPipe FGP-SSA-1500 5 PSI FLEX GAS 150 FT

TracPipe FGP-SSA-1500 5 PSI FLEX GAS 150 FT

TracPipe FGP-SSA-1500 5 PSI FLEX GAS 150 FT

TracPipe FGP-SSA-1500 5 PSI FLEX GAS 150 FT

TracPipe FGP-SSA-1500 5 PSI FLEX GAS 150 FT

TracPipe FGP-SSA-1500 5 PSI FLEX GAS 150 FT

TracPipe FGP-SSA-1500 5 PSI FLEX GAS 150 FT

TracPipe FGP-SSA-1500 5 PSI FLEX GAS 150 FT

TracPipe FGP-SSA-1500 5 PSI FLEX GAS 150 FT

TracPipe FGP-SSA-1500 5 PSI FLEX GAS 150 FT

TracPipe FGP-SSA-1500 5 PSI FLEX GAS 150 FT

TracPipe FGP-SSA-1500 5 PSI FLEX GAS 150 FT

TracPipe FGP-SSA-1500 5 PSI FLEX GAS 150 FT

TracPipe FGP-SSA-1500 5 PSI FLEX GAS 150 FT

TracPipe FGP-SSA-1500 5 PSI FLEX GAS 150 FT

TracPipe FGP-SSA-1500 5 PSI FLEX GAS 150 FT

TracPipe FGP-SSA-1500 5 PSI FLEX GAS 150 FT

TracPipe FGP-SSA-1500 5 PSI FLEX GAS 150 FT

TracPipe FGP-SSA-1500 5 PSI FLEX GAS 150 FT

TracPipe FGP-SSA-1500 5 PSI FLEX GAS 150 FT

TracPipe FGP-SSA-1500 5 PSI FLEX GAS 150 FT

TracPipe FGP-SSA-1500 5 PSI FLEX GAS 150 FT

TracPipe FGP-SSA-1500 5 PSI FLEX GAS 150 FT

TracPipe FGP-SSA-1500 5 PSI FLEX GAS 150 FT

TracPipe FGP-SSA-1500 5 PSI FLEX GAS 150 FT

TracPipe FGP-SSA-1500 5 PSI FLEX GAS 150 FT

TracPipe FGP-SSA-1500 5 PSI FLEX GAS 150 FT

TracPipe FGP-SSA-1500 5 PSI FLEX GAS 150 FT

TracPipe FGP-SSA-1500 5 PSI FLEX GAS 150 FT

TracPipe FGP-SSA-1500 5 PSI FLEX GAS 150 FT

TracPipe FGP-SSA-1500 5 PSI FLEX GAS 150 FT

TracPipe FGP-SSA-1500 5 PSI FLEX GAS 150 FT

TracPipe FGP-SSA-1500 5 PSI FLEX GAS 150 FT

TracPipe FGP-SSA-1500 5 PSI FLEX GAS 150 FT

TracPipe FGP-SSA-1500 5 PSI FLEX GAS 150 FT

TracPipe FGP-SSA-1500 5 PSI FLEX GAS 150 FT

TracPipe FGP-SSA-1500 5 PSI FLEX GAS 150 FT

TracPipe FGP-SSA-1500 5 PSI FLEX GAS 150 FT

TracPipe FGP-SSA-1500 5 PSI FLEX GAS 150 FT

TABLE OF CONTENTS

Chapter 1	Introduction	
1.0	User Warnings	3
1.1	Listing of applicable codes and standards	4
	TracPipe Specification Data Sheet	5
Chapter 2	Description of System and Components	
2.0	Tubing	6
	Fittings	6
	Accessories	6
	Manifolds	6
	Pressure regulators	6
	Protection Devices	6
	Shut-off valves	7
2.1	Material Use and Limitations	7
2.2	System Components	9
	TracPipe Flexible Gas Piping	9
	AutoFlare Fittings	10
	TracPipe Accessories	11
Chapter 3	System configurations and Sizing	
3.1	System configurations	13
3.1A	Series and parallel low-pressure systems	13
3.1B	Dual Pressure Systems	13
3.1C	System Design	14
3.1D	System Pressure Choices	14
3.2	Sizing Methods and Examples	15
3.2A	Use of Sizing Tables	15
3.2B	Sizing Examples	15
	Low-pressure Systems	15
	Elevated Pressure Systems	17
	Medium Pressure Systems	17
3.2C	Sizing Hybrid Systems (Combination Steel/TracPipe Systems)	19
3.2D	Alternate Sizing Method (Sum of Pressure Loss Calculations)	21
3.3	AUTOTRIP™ Low Pressure Excess Flow Valves for Natural Gas and Propane Service	25
3.4	AUTOTRIP™ LFD SERIES Excess Flow Valves for Meter and Branch Line/Manifold Applications	26
3.4.1	Application, and Selection of AUTOTRIP LFD SERIES Excess Flow Valves	27
3.4.2	Gas Piping System Sizing with LFD Series Excess Flow Valves	28
3.4.3	Methods of Sizing	28
3.4.4	Sizing Instructions For AUTOTRIP LFD SERIES EFVs Used With TracPipe CSST Systems	28
3.4.5	Sizing Instructions For AUTOTRIP LFD SERIES EFVs Used With Low Pressure Steel Pipe Systems	29
3.4.6	LFD Installation Instructions	29
3.5	AUTOTRIP AFD SERIES Excess Flow Valves for Appliance Connector Inlet Applications	30
3.5.1	Application and Selection of AUTOTRIP AFD SERIES Excess Flow Valves	31
3.5.2	AFD Installation Instructions	32
3.6	GASBREAKER® EXCESS Flow Valves	33
	AutoTrip “LFD” Series Capacity Charts	34
	Table N-1AT AutoTrip-TracPipe	34
	Table N-3AT AutoTrip-TracPipe	34
	Table N-5AT AutoTrip –TracPipe	35
	Table SP-1AT AutoTrip - Steel Pipe Low Pressure	35
	Table 3.3 AutoTrip “LFD” Series Excess Flow Valves- Propane Conversions	36
	Table P-1AT AutoTrip (Propane Low Pressure System 11 in w.c.) -TracPipe	36
	Table 3.4 AutoTrip - GasBreaker Equivalency Chart	37
	Figure 3.12 Pressure Drop across AutoTrip “LFD” Series EFV at given Flow Rates	38
Chapter 4	Installation Practices	
4.1	General Installation Practices	39
	Minimum Bend Radius	39
	Debris Protection	39
	Support- Vertical Runs/ Horizontal Runs	40
4.2	Fitting Assembly	41
	Tubing Cutting/End Preparation	41

	Assembly Procedure	42
	Minimum Tightening Torque	42
	Re-assembly Procedure	42
4.2A	Trouble Shooting Fitting Connections	43
4.3	Routing	44
	Clearance Holes and Notching	44
4.3A	Concealed Locations for Fittings	44
4.3B	Outdoor Installation Issues	45
4.4	Protection	46
4.4A	Striker Plate Requirements	46
	Spiral Metal Hose Requirements	47
	Thru-penetration Fire Stop UL Classifications	48
4.5	Meter Connections	49
	Termination Mounts/Meter Mounts	49
	Direct Connection	49
4.6	Appliance Connections	50
4.6.1	Moveable Appliances	50
	Termination Fittings with Appliance Connectors	50
4.6.2	Fixed Appliance Connections	50
	Direct Connection	50
4.6A	Pad Mounted, Roof Top Equipment	53
4.6B	Outdoor Appliances	54
4.6C	Fireplace Installations	55
4.7	Manifold Stations	56
	Allowable Locations	56
4.8	Pressure Regulators	57
	Installation Requirements	57
	Vent Limiter Option	57
	Vent Line and Sizing Requirements	57
4.8A	Adjustments	57
4.8B	Regulator Capacity and Pressure Drop	58
4.8C	Over-Pressurization Protection	59
4.9	Underground installations	60
4.9A	Guidelines for underground installations	60
4.9B	TracPipe PS fitting attachment instructions	62
4.9C	Underground ps with Flexible Poly Tubing	63
4.9D	TracPipe PS-II	65
4.9E	TracPipe PS-II fitting attachment Instructions	66
4.10	Electrical Bonding/Grounding	68
4.10A	TracPipe CounterStrike CSST Installations	69
Chapter 5	Inspection Repair and Replacement	
5.1	Minimum Inspection Requirements (Checklist)	71
5.2	Repair/Replacement of Damaged Tubing	72
Chapter 6	Pressure/Leakage Testing	
6.0	Pressure Test Procedure	73
6.1	Pressure Test for Elevated Pressure Systems	73
6.1A	Appliance Connection Leakage Check Procedure	74
6.1B	Regulator Performance	74
Chapter 7	Capacity Tables	
	7 in / 0.5 in WC Drop	76
	8 in / 2 in WC Drop	77
	11 in / 5 in WC Drop	78
	2 PSI / 1 PSI Drop	79
	5 PSI / 3.5 PSI Drop	80
	11 in / 0.5 in WC Drop (LP only)	80
	12-14 in / 2.5 in Drop (LP only)	81
	2 PSI / 1.5 PSI Drop (LP only)	82
7.1	Table PD.1 Pressure Drop per foot for TracPipe (Natural Gas)	83
7.2	Steel Pipe	88
7.2A	Pressure Drop per 100 foot of Steel Pipe	89
Chapter 8	Definitions	91
Appendix A	UL Classification	93
Appendix B	Manufactured Housing Guidelines	96

CHAPTER 1 INTRODUCTION

WARNINGS

SECTION 1.0 — USER WARNINGS

The **TracPipe**® gas piping material (CSST-Corrugated Stainless Steel Tubing) must only be installed by a qualified person who has been trained or otherwise qualified through the **TracPipe Gas Piping Installation Program**. Any installer must also meet qualifications in accordance with state and/or local requirements as established by the administrative authority which enforces the plumbing or mechanical code where the gas piping is installed.

This document provides general instructions for the design and installation of fuel gas piping systems using gas piping material CSST. The guide must be used in conjunction with state and local building codes. **Local codes will take precedence in the event of a conflict between this guide and the local code.** In the absence of local codes, installation must be in accordance with the current edition of *National Fuel Gas Code, ANSI Z223.1/NFPA 54*, the National Standard of Canada, *Natural Gas and Propane Installation Code, CSA B149.1*, the *International Fuel Gas Code, the Federal Manufactured Home Construction and Safety Standards, ICC/ANSI 2.0* or the *Standard on Manufactured Housing, NFPA 501, as applicable*

Sound engineering principles and practices must be exercised for the proper design of fuel gas piping systems, in addition to compliance with local codes. The installation instructions and procedures contained in this Design Guide must be strictly followed in order to provide a safe and effective fuel gas piping system or system modification. All installations must pass customary inspections by the local official having authority prior to having the gas service turned on. All requirements of the local natural gas utility or propane supplier must also be met.

Only the components provided or specified by **OMEGAFLEX** as part of the approved piping system are to be used in the installation.

The use of TracPipe tubing or fittings with tubing or fittings from other flexible gas piping manufacturers is strictly prohibited and may result in serious bodily injury or property damage.

WARNING !

If this system is used or installed improperly, fire, explosion or asphyxiation may result. The installation instructions and applicable local codes must be strictly followed.



OMEGAFLEX®

451 Creamery Way

Exton, PA 19341-2509

610-524-7272 Fax: 610-524-7282

1-800-671-8622 www.omegaflex.com

© Copyright Omega Flex Inc. 1997, 1998, 2001, 2002, 2003, 2004, 2005, 2007

OmegaFlex, TracPipe, AutoFlare, and CounterStrike are registered trademarks of Omega Flex, Inc.

AutoTrip is a trademark of Omega Flex, Inc. registration pending.

SECTION 1.1 — APPLICABLE CODES AND STANDARDS

REGIONAL /MODEL CODES LISTING CSST AS AN ACCEPTABLE GAS PIPING MATERIAL AS OF JULY 2005:

- a. ANSI/IAS LC-1 • CSA 6.26 Standard
- b. CANADA-CSA B149.1 Natural Gas and Propane Installation Code
- c. NFPA 54/ANSI Z 223.1 National Fuel Gas Code
- d. ICBO-Uniform Mechanical Code
- e. BOCA-National Mechanical Code
- f. CABO-1 and 2 Family Dwelling Code
- g. SBCCI-Standard Gas Code
- h. ICC-International Mechanical Code
- i. IAPMO Listing FILE 3682
- j. IAPMO Listing FILE 4665 **TracPipe PS-II**
- k. ICBO Evaluation Services ER-5412.
- l. Factory Mutual “Flexible Piping Systems for Flammable Gases.”
- m. California Mechanical and Plumbing Codes
- n. ICC-International Fuel Gas Code
- o. NFPA 58 LP-Gas Code
- p. UPC-Uniform Plumbing Code 2003
- q. UL Through Penetration Firestop Systems Classified (see Appendix A)
- r. Tested to Code Requirements per ASTM E84 (UL 723)

This Design and Installation Guide has been written in accordance with the most current edition of ANSI LC1 CSA 6.26, Fuel Gas Piping Systems using Corrugated Stainless Steel Tubing (CSST).

WHILE EVERY EFFORT HAS BEEN MADE TO PREPARE THIS DOCUMENT IN ACCORDANCE WITH THE REGIONAL MODEL CODES IN EFFECT AT ITS PRINTING, OMEGAFLEX CANNOT GUARANTEE THAT THE LOCAL ADMINISTRATIVE AUTHORITY WILL ACCEPT THE MOST RECENT VERSION OF THESE CODES.

THE INSTALLER IS ULTIMATELY RESPONSIBLE TO DETERMINE SUITABILITY AND ACCEPTANCE OF ANY BUILDING COMPONENT, INCLUDING GAS PIPING. OMEGAFLEX ASSUMES NO RESPONSIBILITY FOR MATERIALS OR LABOR FOR INSTALLATIONS MADE WITHOUT PRIOR DETERMINATION OF LOCAL CODE AUTHORITY ACCEPTANCE.

TracPipe®

SPECIFICATION DATA SHEET

FGP-SS4-CHART

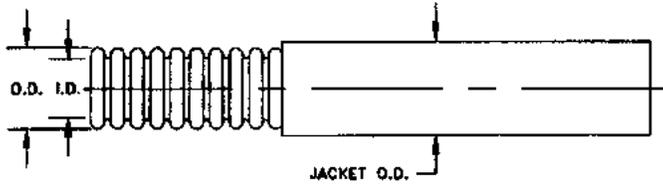

TracPipe® part no.	FGP-SS4-375	FGP-SS4-500	FGP-SS4-750	FGP-SS4-1000	FGP-SS4-1250	FGP-SS4-1500	FGP-SS4-2000
Size (inch)	3/8"	1/2"	3/4"	1"	1-1/4"	1-1/2"	2"
EHD (AGA size)	15	19	25	31	37	46	62
Jacket O.D. (max.)	.668	.868	1.108	1.383	1.665	1.920	2.590
Inside Diameter (nom)	.440	.597	.820	1.040	1.290	1.525	2.060
Wall Thickness (in.)	.01	.01	.01	.01	.012	.012	.012

*EHD (Effective Hydraulic Diameter) A relative measure of Flow Capacity; This number is used to compare individual sizes between different manufacturers. The higher the EHD number the greater flow capacity of the piping.

STRAIGHT AUTO-FLARE FITTINGS

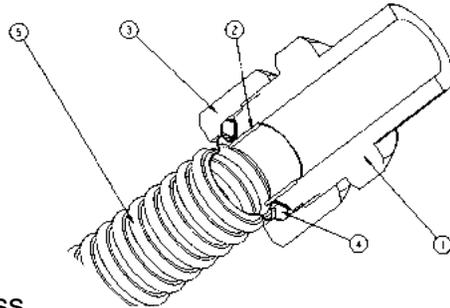

1. ADAPTER – Brass
2. INSERT – Stainless Steel
3. NUT—Brass
4. SPLIT-RINGS – Brass or Stainless Steel
5. FLEXIBLE PIPE – Stainless Steel

AVAILABLE IN SIZES							
Tube size	3/8"	1/2"	3/4"	1"	1-1/4"	1-1/2"	2"
NPT Thread	1/2" or 3/8"	1/2" or 3/4"	3/4" or 1/2"	1" or 3/4"	1-1/4"	1-1/2"	2"

FLANGE MOUNT AUTO-FLARE FITTINGS

1. ADAPTER – Brass
2. INSERT – Stainless Steel
3. FLANGE NUT – Brass
4. SPLIT-RINGS – Brass or Stainless Steel
5. FLANGE – Malleable Iron/Brass
6. FLEXIBLE PIPE – Stainless Steel

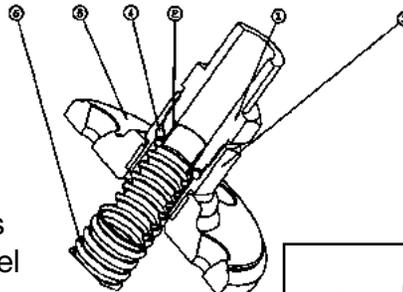

AVAILABLE IN SIZES					
Tube Size	3/8"	1/2"	3/4"	1"	1-1/4"
NPT Thread	1/2" or 3/8"	1/2"	3/4"	1"	1-1/4"

CONSULT FACTORY FOR OTHER TERMINATION METHODS

CHAPTER 2

DESCRIPTION of SYSTEM and COMPONENTS

SECTION 2.0 — *TracPipe* FLEXIBLE GAS PIPING MATERIAL DESCRIPTION

1. TUBING

The *TracPipe* fuel gas piping system consists of corrugated, semi-rigid stainless steel tubing with brass mechanical attachment fittings terminating in NPT pipe fittings for easy attachment to traditional black iron pipe systems and direct connections to gas appliances.

Tubing is available in sizes 3/8 inch, 1/2 inch, 3/4 inch, 1 inch, 1-1/4 inch, 1-1/2 inch, and 2 inch.

The 300 series stainless steel tubing is jacketed, with a non-metallic cover which provides ease of running through joists, studs, and other building components. The jacket is

marked at intervals with the amount of tubing left on the reel, for quick measurement.



2. FITTINGS

Straight NPT pipe fittings are standard and are available in sizes shown above to fit all tubing. Additional fittings include termination mount and flange-mount straight and 90 degree elbow fittings for termination of gas lines near movable appliances; and meter termination accessories for support of *TracPipe* at utility meter sets on building exteriors and roof penetrations. Tee fittings are available for addition of branch lines into tubing runs; reducer tees are available in popular sizes and pipe outlet tees terminate in pipe threads on the outlet leg for size changes utilizing available black iron reducer fittings.

3. ACCESSORIES

Accessories are available for expansion of the flexible piping material and additions to existing fuel gas piping systems. These accessories include:

- A. Manifolds — allow parallel installations with “home runs” to each appliance. 1/2 inch female NPT outlets and 3/4 inch and 1/2 inch female NPT inlets. Large size manifolds are also available for use with commercial size *TracPipe*.



- B. Pressure Regulators: pounds to inches - for use in elevated pressure system installations (over 14 inches water column - one half psi) to reduce pressure to standard low pressure for appliances.



Regulators are available for use on natural and propane gas. Regulators are equipped with approved vent limiters except for the REG-7 size.

- C. Protection Devices-for use where flexible piping passes through studs, joists and other building materials and is restricted from moving to avoid nails, screws and other puncture threats.



There are four striker plate configurations made from stamped steel and specially hardened to resist penetration from screws and pneumatic nail guns. These are quarter-striker, half striker full-striker and 6" X 17" flat plate striker. Spiral wound galvanized steel "floppy" conduit is available for use as additional protection.

D. Shut-off Valves-for use in elevated pressure installations: 2 psi up to 5 psi.

(Standard gas-cocks should be used at appliance stub outs and other low pressure areas of the piping system.) Brass



lever-handle ball valves supplied by **OmegaFlex** are rated for 5 psi use and are available in 1/2 inch and 3/4 inch sizes.

SECTION 2.1 — MATERIAL USE AND LIMITATIONS

This Design and Installation Guide has been written in accordance with the most current edition of ANSI LC 1 CSA 6.26, FUEL GAS PIPING SYSTEMS USING CORRUGATED STAINLESS STEEL TUBING (CSST).

This Design Guide is intended to aid the professional gas pipe installer in the design, installation and testing of flexible fuel gas piping systems for residential, commercial and industrial buildings. It is not possible for this guide to anticipate every variation in construction style, building configuration, appliance requirement, or local restriction. This document will not therefore cover every application. The user should either exercise his own engineering judgment on system design and installation, or seek technical input from other qualified sources. Additional information pertaining to gas piping systems is available from your local gas utility or propane supplier.

Some of the special usage features of **TracPipe** gas piping are outlined below:

1. Flexible gas piping is used to provide safe, efficient, timely installation of fuel gas piping within buildings, residential, commercial, and industrial, or for outdoor connections to appliances that are attached or in close proximity to the building.
2. Flexible gas piping can be routed in most locations where traditional gas piping materials are installed: inside hollow wall cavities, along or through floor joists in basements, on top of the joists in attics, on roof tops or along soffits or in chases outside of buildings. **TracPipe** gas piping has been tested and is listed by CSA International for both outdoor and indoor use.
3. **TracPipe** is listed by CSA International for fuel gas use in the USA and Canada for pressures up to 25 psi. For local gas utility approved use only, **TracPipe** has been tested for use up to 125 PSI for sizes 3/8" up to 1-1/4", and for use up to 25 psi for sizes 1-1/2" and 2".
4. In North America, the most common pressure for Natural Gas is 6-7 inches water column, standard low pressure. Elevated pressures of either 2 psi or one half psi are also available from utilities in most areas for new residential construction. 5 PSI systems are commonly installed in commercial or industrial buildings. Elevated pressures allow the use of smaller diameter piping, while providing for increased loads and longer length runs.
5. Flexible gas piping can be used for Natural gas and propane (Liquefied Petroleum gas) and other fuel gases recognized in NFPA 54 National Fuel Gas Code.
6. **TracPipe** CSST with the yellow polyethylene jacket and **CounterStrike** with black jacket have been tested by Underwriters Laboratory to UL723 (ASTM E84) Surface Burning Characteristics with flame spread

and smoke density ratings meeting the requirements of ANSI/CSA LC-1 for use in air ducts and plenums. It is mandatory, however, to follow fire and building code requirements in all installations.

7. For underground or under slab burial the flexible gas piping run must be encased in a sleeve of polyethylene, or other approved water resistant material. See Section 4.9, **Underground Installations**. Sleeved runs under concrete slabs beneath buildings must be installed as required by local codes. Most codes require venting of the sleeves under buildings to the outdoors. This can be accomplished using Pre-sleeved **TracPipe PS** or **PS-II with available accessories**.
8. Flexible gas piping can be used in conjunction with steel pipe (black iron or galvanized) in either new construction or renovation and replacement piping installations. All **TracPipe** fittings terminate in standard NPT male or female pipe threads to interface with appliances, valves, unions and couplings.
9. For retrofit installations, **TracPipe** can be snaked through hollow wall cavities without major restoration as is typical when running rigid pipe through existing construction. The replacement or addition of gas appliances, fireplaces, and gas logs is greatly facilitated with flexible piping on reels requiring no special tooling or oily threading equipment.
10. **TracPipe** gas piping can be run directly to the shut off valves of most fixed appliances without installing an appliance connector. For moveable appliances such as ranges or dryers, the use of an approved flexible appliance connector is required in most jurisdictions. **TracPipe** cannot be substituted as a connector for this use when the appliance is free to move for cleaning, etc.
11. **TracPipe AutoFlare**[®] fittings have been tested by CSA International (formerly the American Gas Association Laboratories) and are listed for use in concealed locations as defined in NFPA 54 National Fuel Gas Code, The Uniform Plumbing Code, and The International Fuel Gas Code. This facilitates installation of the key valves required for gas fireplaces in many jurisdictions. Concealed fittings are also desirable when adding tees for branch runs in series configurations and in other installation situations where locating a **TracPipe** fitting in an accessible location is not practical.

SECTION 2.2 — SYSTEM COMPONENTS

TracPipe Flexible Gas Piping

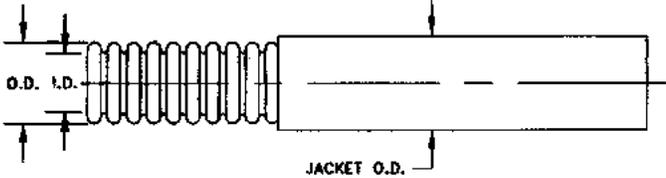
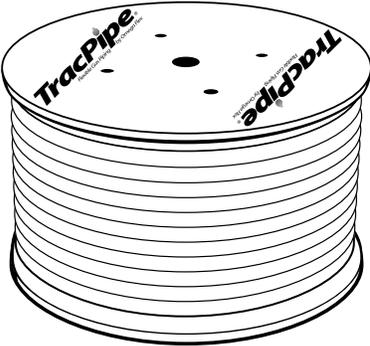
Component	Material	Description/Dimensions																																								
<p>TracPipe Flexible Gas Piping</p>	<p>Corrugated Stainless Steel (300 Series) with Polyethylene Jacket</p>	<div style="text-align: center;">  </div> <table border="1" data-bbox="625 600 1468 808"> <thead> <tr> <th>part no.</th> <th>FGP-SS4-375</th> <th>FGP-SS4-500</th> <th>FGP-SS4-750</th> <th>FGP-SS4-1000</th> <th>FGP-SS4-1250</th> <th>FGP-SS4-1500</th> <th>FGP-SS4-2000</th> </tr> </thead> <tbody> <tr> <td>Size (inch)</td> <td>3/8"</td> <td>1/2"</td> <td>3/4"</td> <td>1"</td> <td>1-1/4"</td> <td>1-1/2"</td> <td>2"</td> </tr> <tr> <td>EHD (AGA size)</td> <td>15</td> <td>19</td> <td>25</td> <td>31</td> <td>37</td> <td>46</td> <td>62</td> </tr> <tr> <td>Jacket O.D. (max.)</td> <td>.668</td> <td>.868</td> <td>1.108</td> <td>1.38</td> <td>1.665</td> <td>1.920</td> <td>2.590</td> </tr> <tr> <td>Inside Dia. (nom)</td> <td>.440</td> <td>.597</td> <td>.820</td> <td>1.040</td> <td>1.290</td> <td>1.525</td> <td>2.060</td> </tr> </tbody> </table> <p>*EHD (Effective Hydraulic Diameter) A relative measure of Flow Capacity; This number is used to compare individual sizes between different manufacturers. The higher the EHD number the greater flow capacity of the piping.</p>	part no.	FGP-SS4-375	FGP-SS4-500	FGP-SS4-750	FGP-SS4-1000	FGP-SS4-1250	FGP-SS4-1500	FGP-SS4-2000	Size (inch)	3/8"	1/2"	3/4"	1"	1-1/4"	1-1/2"	2"	EHD (AGA size)	15	19	25	31	37	46	62	Jacket O.D. (max.)	.668	.868	1.108	1.38	1.665	1.920	2.590	Inside Dia. (nom)	.440	.597	.820	1.040	1.290	1.525	2.060
part no.	FGP-SS4-375	FGP-SS4-500	FGP-SS4-750	FGP-SS4-1000	FGP-SS4-1250	FGP-SS4-1500	FGP-SS4-2000																																			
Size (inch)	3/8"	1/2"	3/4"	1"	1-1/4"	1-1/2"	2"																																			
EHD (AGA size)	15	19	25	31	37	46	62																																			
Jacket O.D. (max.)	.668	.868	1.108	1.38	1.665	1.920	2.590																																			
Inside Dia. (nom)	.440	.597	.820	1.040	1.290	1.525	2.060																																			
<p>TracPipe on Reels</p>	<p>Plywood Reels for packaging</p>	<div style="text-align: center;">  </div> <p style="text-align: center;">Note: other reel lengths available upon request.</p> <table border="1" data-bbox="656 1423 1438 1906"> <thead> <tr> <th>Pipe Size</th> <th>Standard Reel Length</th> <th>Weight Long Reel</th> </tr> </thead> <tbody> <tr> <td>3/8 inch</td> <td>250 feet 100 feet</td> <td>29 pounds</td> </tr> <tr> <td>1/2 inch</td> <td>500 feet 250 feet 100 feet 50 feet</td> <td>87 pounds</td> </tr> <tr> <td>3/4 inch</td> <td>250 feet 100 feet</td> <td>55 pounds</td> </tr> <tr> <td>1 inch</td> <td>180 feet 100 feet</td> <td>60 pounds</td> </tr> <tr> <td>1-1/4 inch</td> <td>250 feet 150 feet</td> <td>115 pounds</td> </tr> <tr> <td>1-1/2 inch</td> <td>250 feet 150 feet</td> <td>125 pounds</td> </tr> <tr> <td>2 inch</td> <td>150 feet</td> <td>92 pounds</td> </tr> </tbody> </table>	Pipe Size	Standard Reel Length	Weight Long Reel	3/8 inch	250 feet 100 feet	29 pounds	1/2 inch	500 feet 250 feet 100 feet 50 feet	87 pounds	3/4 inch	250 feet 100 feet	55 pounds	1 inch	180 feet 100 feet	60 pounds	1-1/4 inch	250 feet 150 feet	115 pounds	1-1/2 inch	250 feet 150 feet	125 pounds	2 inch	150 feet	92 pounds																
Pipe Size	Standard Reel Length	Weight Long Reel																																								
3/8 inch	250 feet 100 feet	29 pounds																																								
1/2 inch	500 feet 250 feet 100 feet 50 feet	87 pounds																																								
3/4 inch	250 feet 100 feet	55 pounds																																								
1 inch	180 feet 100 feet	60 pounds																																								
1-1/4 inch	250 feet 150 feet	115 pounds																																								
1-1/2 inch	250 feet 150 feet	125 pounds																																								
2 inch	150 feet	92 pounds																																								

AutoFlare® Fittings

The fittings and accessories pictured on the following pages are representative of the range of products available from **TracPipe**. Refer to the latest **TracPipe** Price Sheet for a complete listing of part numbers.

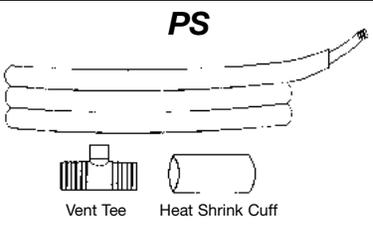
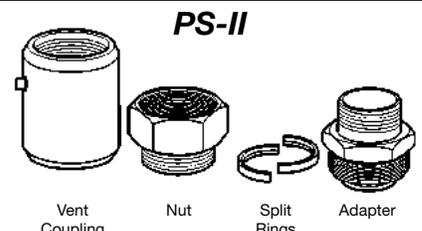
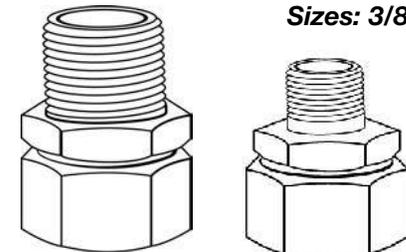
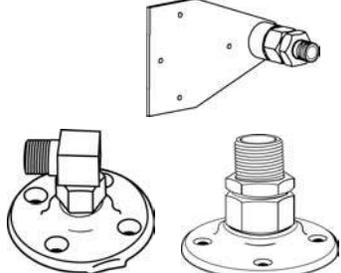
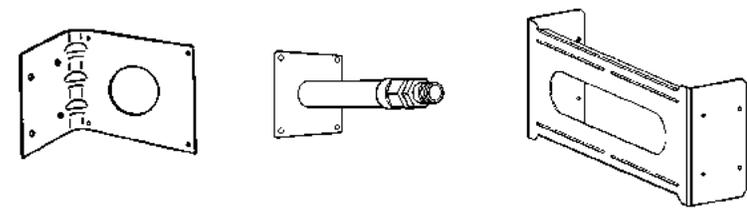
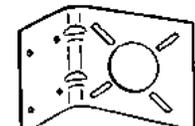
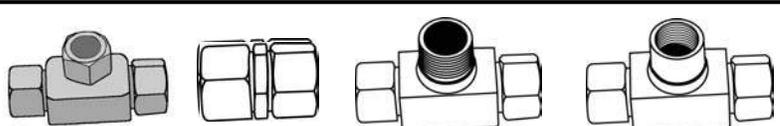
Component	Material	Description/Dimensions	
TracPipe PS & PS-II Accessories	Black Polyethylene Sleeved TracPipe	<p>PS</p>  <p>Vent Tee Heat Shrink Cuff</p>	<p>PS-II</p>  <p>Vent Coupling Nut Split Rings Adapter</p>
Straight Mechanical Fitting Fitting Reducer Fitting	Brass Fitting Autoflare Insert	 <p>Sizes: 3/8, 1/2, 3/4, 1, 1-1/4, 1-1/2 and 2 inch</p> <p>Note size 3/8 fitting has either 1/2" NPT or 3/8" NPT Thread</p>	
Termination and Flange Mount Fittings Straight and 90 Elbow	Brass Fitting Autoflare Insert Brass Flange	 <p>Sizes: 3/8, 1/2, 3/4, 1 inch and 1-1/4 inches</p> <p>Note size 3/8 fitting has either 1/2" NPT or 3/8" NPT Thread</p> <p>Elbow Sizes: 3/8 in. and 1/2 in.</p>	
Meter Termination Fitting Stud Bracket	Brass Fitting Autoflare Insert Galv. steel Mounting Bracket		
Flange Mounting Bracket	Galv. Steel	 <p>One size fits all: Size 3/8 through 1-1/4 inches</p>	
Tee Fitting & Coupling	Brass Tee Fitting & Coupling Autoflare Insert	 <p>Sizes: 3/8, 1/2, 3/4, 1, 1-1/4, 1-1/2, and 2 inch</p> <p>Reducer tees available for 1/2, 3/4, 1, 1-1/4, 1-1/2, and 2 inch sizes</p>	

TracPipe Accessories

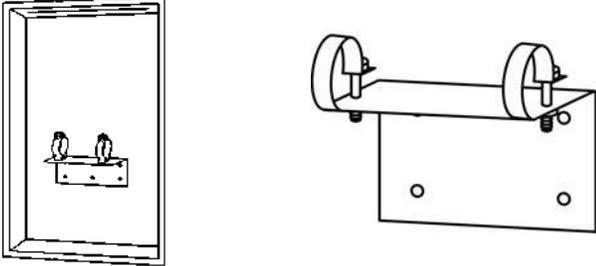
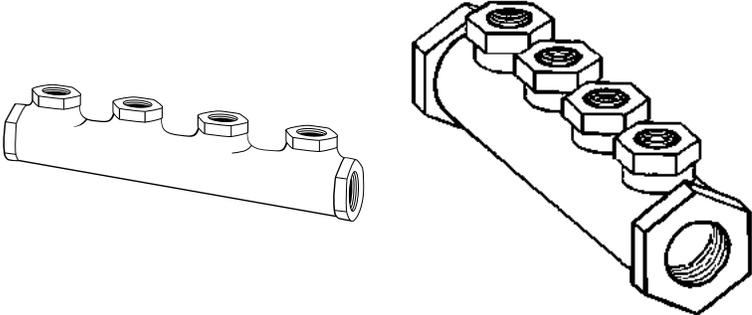
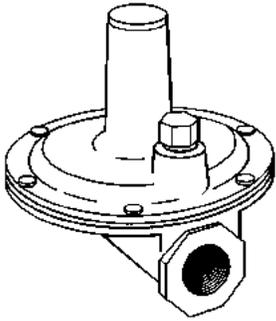
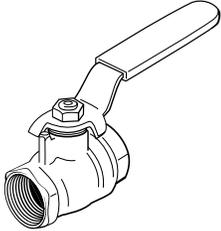
Component	Material	Description/Dimensions
<p style="text-align: center;">Load Center</p> <p style="text-align: center;">Manifold Bracket</p>	<p style="text-align: center;">Painted Steel</p> <p style="text-align: center;">Galvanized Steel</p>	
<p style="text-align: center;">Multi- Port Manifolds</p>	<p style="text-align: center;">Malleable Iron Poly Coated</p>	
<p style="text-align: center;">Pressure Regulators</p>	<p style="text-align: center;">Cast Housing Suitable for Outdoor Use</p>	 <p style="text-align: right;">Sizes: 1/2 inch & 3/4 inch & 1-1/4 inch Regulator includes approved vent limiting device for REG 3 (1/2 in.) and REG 5A (3/4 in.).</p> <p style="text-align: right;">Note: Stainless steel High Pressure tags are available for use where required by code</p>
<p style="text-align: center;">Shut Off Valves</p>	<p style="text-align: center;">Brass Housing with Stainless Steel Ball</p>	 <p style="text-align: right;">Sizes: 1/2 inch & 3/4 inch</p>

TracPipe Accessories

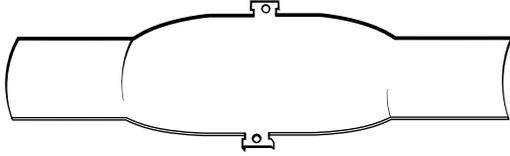
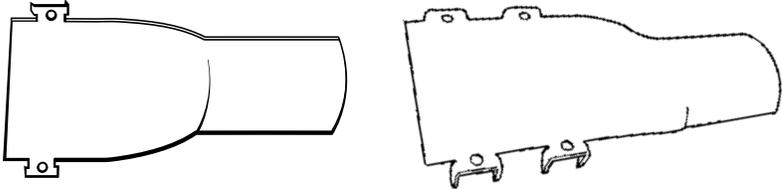
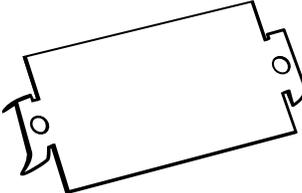
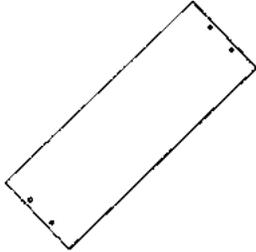
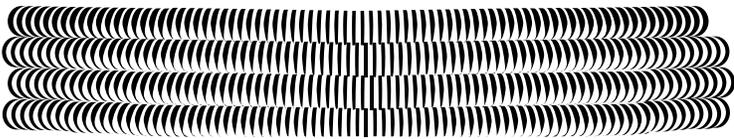
Component	Material	Description/Dimensions
Full Striker Plate	Carbon Steel Hardened	 <p style="text-align: center;"><i>size: 3" x 12"</i></p>
Half Striker Plate & Three Quarter Striker Plate	Carbon Steel Hardened	 <p style="text-align: center;"><i>size: 3" x 7"</i> <i>size: 3" x 8"</i></p>
Quarter Striker Plate	Carbon Steel Hardened	 <p style="text-align: center;"><i>size: 3" x 2"</i></p>
6 x 17 Striker Plate	Carbon Steel Hardened	 <p style="text-align: center;"><i>size: 6" x 17"</i></p>
Floppy Strip Wound Conduit	Type RW Galvanized Steel	 <p style="text-align: center;"><i>sizes: Fits 3/8", 1/2", 3/4", 1", 1-1/4", 1-1/2" and 2" TracPipe</i></p>

CHAPTER 3

SYSTEM CONFIGURATIONS AND SIZING

SECTION 3.1 — SYSTEM CONFIGURATIONS

There are several piping system options available to the installer using **TracPipe** gas piping material. This flexibility of design is one of the major benefits of CSST.

3.1A — LOW PRESSURE SYSTEMS

1. **SERIES:** A series layout is the most common arrangement utilized for black iron pipe. This consists of a main run with tees branching off to each appliance.

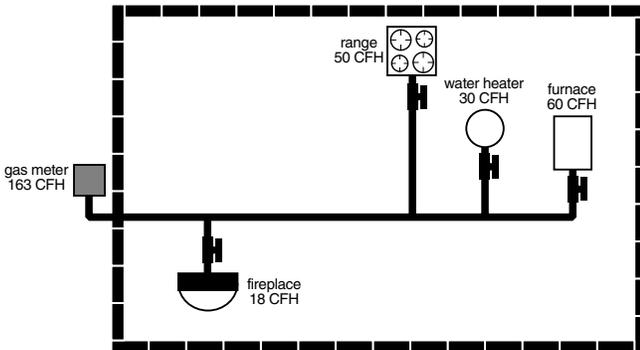

Series Layout

2. **PARALLEL:** A parallel system consists of a central distribution manifold with branch runs to the appliances. This is usually accomplished by providing a main supply line to a manifold and installing “home runs” to each appliance location. In the parallel system shown below the pressure is not elevated above 1/2 pound and no regulator is required.

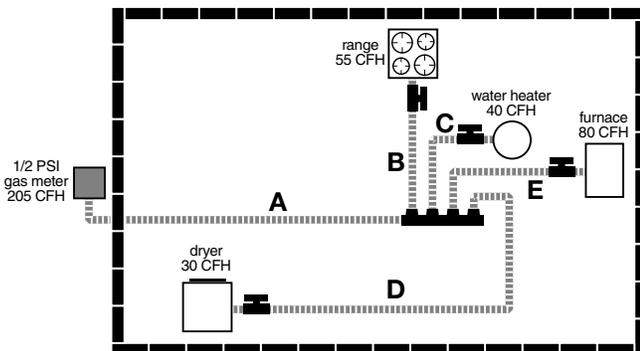

Parallel Layout

3.1B — DUAL PRESSURE SYSTEMS

Elevated pressure systems (2 psi for residential and up to 5 psi for commercial installations) are usually piped with one or more house line regulators (pounds-to-inches) followed by a manifold and runs to each of the appliances. It is possible that these runs to appliances may contain tees branching off to an additional appliance where gas loads permit.

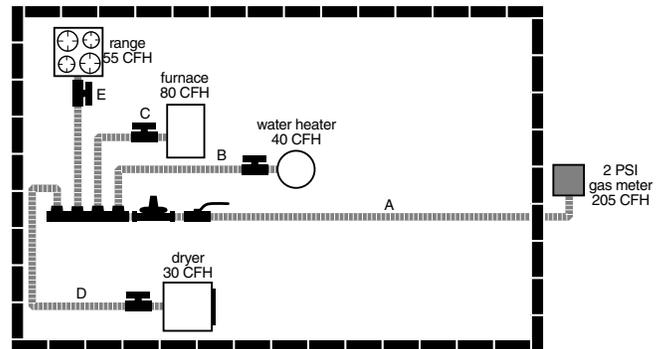

Dual Pressure System Layout

NOTE:
HYBRID SYSTEMS – FLEXIBLE GAS PIPE and RIGID BLACK PIPE COMBINATIONS. In low or medium pressure systems, it is often advantageous to use both corrugated stainless steel tubing and rigid pipe in the same system. This is the case when a larger diameter main branch is required to provide for the total appliance load in a parallel system. **TracPipe** is certified for use in combination with black iron pipe and copper tube gas piping systems. For additional information on Hybrid Systems see examples showing the method for sizing hybrid systems using both **TracPipe** and black iron pipe. These are included in the SIZING EXAMPLES section of this manual. Refer to Section 3.2C

SECTION 3.1C — SYSTEM DESIGN

1. Prepare a sketch or layout of the gas piping system you are about to install. The information you will need is the location of each appliance, the point of delivery (location of utility meter or second stage LP regulator), appliance load demands, and possible pipe routing locations. The load demand data is usually available on the appliance manufacturer's nameplate, or can be provided by the builder.
2. Determine local piping restrictions prior to installing flexible gas piping. The major code bodies in North America have written Corrugated Stainless Steel Tubing into the latest revisions of their mechanical codes, but local and state adoption of these codes often lags behind. CONFIRM THAT THE LOCAL CODE AUTHORITY HAS ACCEPTED THE USE OF FLEXIBLE GAS PIPING. Your **TracPipe** distributor should be able to provide that information but confirmation by the installer should be made where there is a question.

SECTION 3.1D — SYSTEM PRESSURE CHOICES

1. NATURAL GAS-Determine the delivery pressure provided by the Local Distribution Utility where the piping will be installed.
 - a. LOW PRESSURE-6 to 7 inches water column-equivalent to 4 ounces or 1/4 pound is the standard pressure supplied by natural gas utilities in the USA and Canada.
 - b. MEDIUM PRESSURE-1/2 POUND-12 to 14 inches water column-Is available from many natural gas utilities as an enhanced pressure supply. The increase in pressure provides for reductions in pipe size and does not require a pressure regulator. Most natural gas

appliances manufactured for use in the US and Canada are designed to operate up to a maximum of 14 inches water column.

- c. ELEVATED PRESSURE-2 PSI -Is the highest natural gas pressure usually supplied within residential buildings in North America. This pressure always requires the installation of a pounds-to-inches house line regulator between the utility meter set and the appliances.
2. PROPANE (LP GAS)-Is typically supplied within residential buildings at 11 inches water column, set at the second stage regulator mounted outside the building. Propane can also be utilized at medium pressure, with the use of a 13-14 inch setting. For 2 PSI Propane elevated pressure the Maxitrol regulator used is FGP-REG-3P.(which is factory set at 11 inches water column.) A second stage regulator which reduces 10 psi from the tank to 2 psi must be used. (e.g. Fisher model R312E).

NOTE: *TracPipe* has been tested by CSA International (formerly AGA Laboratories) for a working pressure of 125 PSI for sizes 3/8" through 1-1/4" and 25 PSI for sizes 1-1/2 & 2".

PRESSURE CONVERSION CHART

1/4 PSI	=	7" w.c.	=	4 oz.
1/2 PSI	=	14" w.c.	=	8 oz.
1 PSI	=	28" w.c.	=	16 oz.
2 PSI	=	56" w.c.	=	32 oz.

SECTION 3.2 SIZING METHODS and EXAMPLES

SECTION 3.2A — USE OF SIZING TABLES

This Chapter includes flexible gas piping sizing procedures for both low pressure and elevated pressure systems. Every piping system introduces pressure loss to the fluid flowing within. The amount of loss depends on the piping size and the gas flow, expressed in cubic feet per hour (and converted to BTU's). The object of the sizing exercise is to determine the smallest size piping which will introduce the allowed pressure loss or drop within the length of piping required. Sizing Tables (Capacity Charts) provide the maximum flow capacity for a given length of run for each pipe size. A different sizing table is used for each system pressure and pressure drop combination.

1. The low pressure series system (standard arrangement) is sized in the same way as a conventional low pressure black iron pipe system using **TracPipe** sizing tables or tables found in National Fuel Gas Code NFPA 54. This method is known as the "Branch Length Method". Pressure drop in a low pressure system is usually limited to 1/2 inch water column over the system.
2. Elevated pressure systems incorporate two operating pressures downstream of the utility meter set. The first pressure, set by the service regulator at the meter, is usually 2 PSI. This part of the system is sized separately and ends at the pounds-to-inches regulator. The allowable pressure loss for this part of the system must be added to the effect of the regulator to determine the available pressure at the regulator outlet. The chart in Section 4.8B shows pressure losses for maximum loads through the regulator.
3. For a 2 PSI system, the proper drop is usually 1 PSI for this part of the system; this allows for the approximate 3/4 PSI regulator drop downstream and provides the 1/4 PSI (6-7 inches w.c.) necessary for appliances. The regulator reduces the pressure from pounds to 8 inches water column.

This part of the system is sized the same as a low pressure system, except that a special table N-3 is used allowing 3 inches of water column drop. These lines are typically sized for only one appliance load installed as a "home run" from the manifold.

SECTION 3.2B — SIZING EXAMPLES BRANCH LENGTH METHOD

To size each of the following systems, determine the required size for each section and outlet. To size each section of the system, determine both the total gas load for all appliances and the maximum distance (longest length) in which a particular section delivers gas.

EXAMPLE 1 LOW PRESSURE SYSTEM SERIES ARRANGEMENT

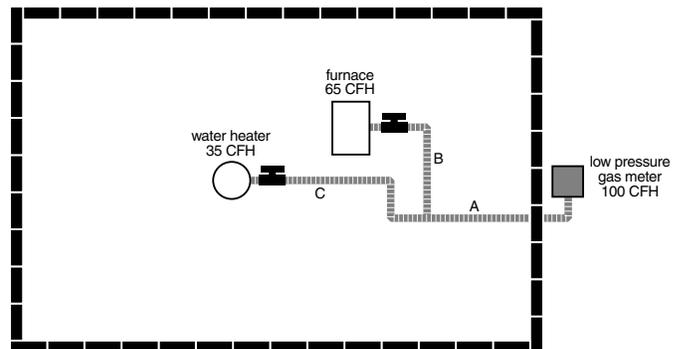
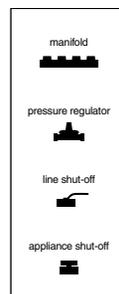

Figure 3-1



LENGTH OF RUNS

A = 10 Feet

B = 10 Feet

C = 15 Feet

Supply pressure 6 inches w.c.
Allowable drop 0.5 inches w.c.

1. The system presented in figure 3-1 is typical of a single family installation in which there are a limited number of appliances located in one general area. The supply pressure is 6 inches water column and the allowable drop is 1/2 inch.

2. To size section A, determine the longest run from the meter that includes section A and the total gas load it must deliver:

- Meter to Furnace is 20 ft. (A+B)
- Meter to Water Heater is 25 ft. (A+C). This is the longest run.
- Determine the maximum load transported by Section A
- Furnace plus Water Heater = 100 cfh (100,000 BTU)
- Select Table N-1 “Low Pressure 6 inches- 1/2 inch w.c. drop”
- Using the longest run method, select the column showing the measured length, or the next longest length if the table does not give the exact length. Referring to table N-1 the column for 25 feet of piping shows that sizes 3/8 and 1/2 are too small and the next available size is 3/4 supplying 132 cfh.
- The correct size is 3/4".

3. To size Section B, determine the length of run from the meter to the Furnace and the load delivered:

- Length is 20 ft (A+B) and load is 65 cfh (65,000 BTU)
- Table N-1 shows that size 1/2" supplies 67 cfh
- The correct size is 1/2".

4. To size Section C, determine the length of run from the meter to the Water Heater and the load delivered:

- Length is 25 ft (A+C) and load is 35 cfh (35,000 BTU)
- Table N-1 shows that size 1/2" is required, because size 3/8" only supplies 27 cfh (27,000 BTU)
- The correct size is 1/2"

EXAMPLE 2 MEDIUM PRESSURE 12-14 INCHES W.C. (1/2 PSI)

1. The system shown in Figure 3-2 is typical of a single family installation with several appliances. The arrangement chosen is

parallel. The MEDIUM PRESSURE SYSTEM (1/2 PSI) allows a higher pressure drop (6 inches Water column) than is available with low pressure systems.

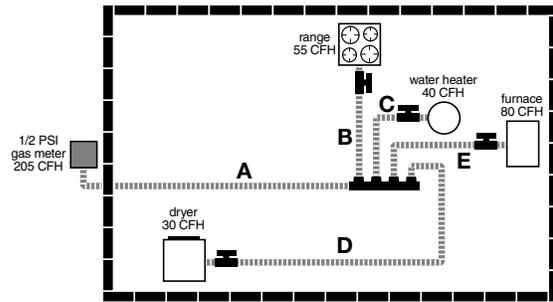
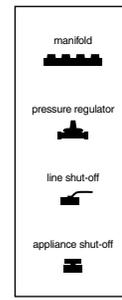

Figure 3-2

LENGTH OF RUNS



- A = 10 Feet
- B = 20 Feet
- C = 10 Feet
- D = 40 Feet
- E = 10 Feet

Supply pressure 1/2 PSI (12"-14" w.c.)
Allowable drop: 6" w.c.

2. To size SECTION A, determine the LONGEST RUN from the meter to the furthest appliance.

- Meter to dryer is 50 feet (10+40) A+D
- Determine maximum load transported by section A
- Dryer + Range + Water heater + Furnace = 205 cfh (205,000 BTU)
- Select table N-4 “Medium Pressure 1/2 PSI with 6 inch drop”. Table N-4 shows that 1/2" size is too small for 205 cfh at 50 ft. but 3/4" can handle 315 cfh.
- The correct size is 3/4"

3. To size SECTION B, the distance from the meter to the range is 30 ft (10+20) A+B

- Load is 55 cfh (55,000 BTU)
- Table N-4 shows that 3/8" size can handle 90cfh
- The correct size for section B is 3/8"

4. To size SECTION C, the distance from the meter to the water heater is 20 ft (10+10) A+C

- Load is 40 cfh (40,000 BTU)
- Table N-4 shows that that 3/8" size

- can handle 112cfh
 - The correct size for section C is 3/8"
- To size SECTION D, the distance from the meter to the dryer is 50 ft (10+40) A+D
 - Load is 30 cfh (30,000 BTU)
 - Table N-4 shows that that 3/8" size can handle 69cfh at 50 feet
 - The correct size for section D is 3/8"
 - To size SECTION E, the distance from the meter to the furnace is 20 ft (10+10) A+E
 - Load is 80 cfh (80,000 BTU)
 - Table N-4 shows that that 3/8" size can handle 112cfh at 20 feet
 - The correct size for section E is 3/8"

EXAMPLE 3 ELEVATED PRESSURE 2 PSI SYSTEM PARALLEL ARRANGEMENT

- The system shown in figure 3-3 is adapted for multifamily or single family application with an extended (100 feet) tubing run from the meter to the regulator. The 2 PSI system is well adapted to handle the long runs required in multifamily buildings with centralized meter banks.
- To size section A determine the entire gas load it will deliver

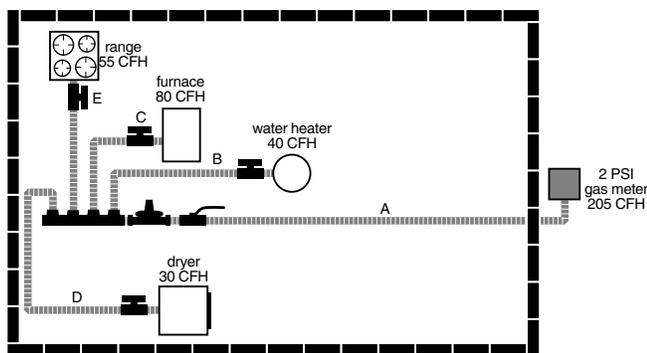
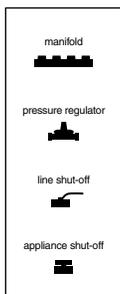

Figure 3-3



LENGTH OF RUNS

- A = 100 Feet
- B = 15 Feet
- C = 10 Feet
- D = 25 Feet
- E = 20 Feet

Supply pressure 2 PSI
Allowable drop: 1 PSI up to reg.
3 inches w.c.-reg. to appliance

- furnace + water heater + dryer + range = 80 cfh + 40 cfh + 30 cfh + 55cfh = 205 cfh (205,000 BTUH) Select Table N-5 "Elevated Pressure 2 PSI with 1 PSI drop" This is the standard table chosen to stay within the Maxitrol 325-3 regulator capacity. See note below.
 - Length is 100 ft.
 - Table N-5 shows that 3/8" size is too small for 205 cfh but 1/2" can handle 222cfh.
 - The correct size is 1/2"
- To size each of the other sections:

Select Table N-3 "Regulator Outlet 8.0 inches w.c with a drop of 3.0 inches w.c

- Section B is 15 feet with a 40 cfh load 3/8" has a capacity of 90 cfh
- Section C is 10 feet with a 80 cfh load 3/8" has a capacity of 112 cfh
- Section D is 25 feet with a 30 cfh load 3/8" has a capacity of 69 cfh
- Section E is 20 feet with a 55 cfh load 3/8" has a capacity of 78 cfh
- The correct size for all these runs is 3/8"

NOTE: at 250 cfh gas flow the FGP-REG-3 regulator contributes 3/4 PSI drop to the system. (see chart below). The low pressure part of the system downstream of the regulator requires the standard 1/4 PSI to power appliances. Deducting the 3/4 psi drop and the 1/4 psi load the maximum allowable drop for the meter run is 1 psi. Start with 2 PSI - 3/4 drop for regulator - 1/4 left for Appliance = 1 PSI drop for section A.

Capacities and Pressure Drop

Pressure Drop through Regulator
Based on flow in cubic feet per hour

P/N	7" w.c.	1/2 psi	3/4 psi	1 psi
FGP-REG-3	145	204	250	289
FGP-REG-5A	338	476	583	673
FGP-REG-7L	690	972	1191	1375

**EXAMPLE 4 MEDIUM
PRESSURE 12-14 INCHES W.C. 1/2 PSI)
PARALLEL SYSTEM WITH A SERIES BRANCH**

1. The system shown in Figure 3-4 has a barbeque installed nearby the range. A parallel arrangement was chosen for the medium pressure system (12 inch W.C. with 6 inches W.C. drop) with a single run feeding both range and barbeque in series.

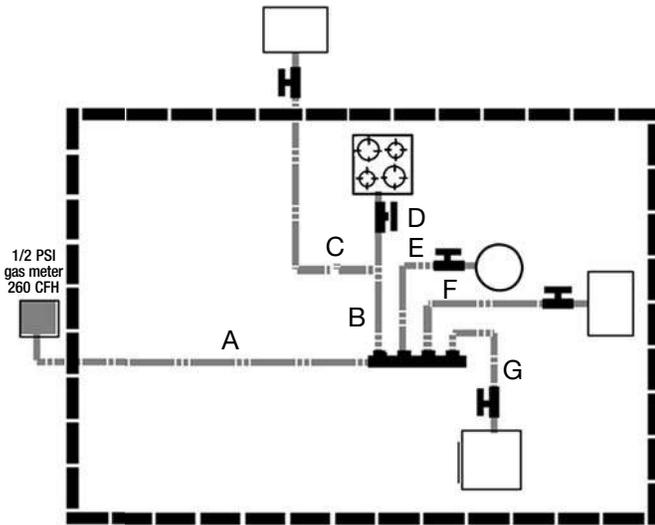

Figure 3-4

LENGTH OF RUNS

- A = 20 Feet
- B = 35 Feet
- C = 20 Feet
- D = 10 Feet
- E = 10 Feet
- F = 10 Feet
- G = 15 Feet

2. To size SECTION A, determine the length of the longest run from the meter and the entire gas load it must deliver:

- Range + Barbeque + Water heater + Furnace +Dryer = 260 CFH (260,000 BTUH).
- Meter to barbeque is 75 ft (A+B+C) This is the longest length
- Select Table N-4 Medium Pressure. Table N-4 shows that 1" is required for 260 CFH at 75 ft (using next longer distance 80 ft column)
- The correct size is 1"

3. To size SECTION B, the line from the manifold serves both the range and the barbeque.

- Total load is 105 CFH (105,000 BTUH)
- Longest length is 75 feet (A+B+C) from the meter to the barbeque
- Table N-4 shows that size 1/2" can handle 116 CFH at 80 ft
- The correct size is 1/2"

4. To size SECTION C, the distance from the meter to the barbeque is 75 ft (A+B+C)

- Load is 55 CFH (55,000 BTUH).
- Table N-4 shows that size 3/8" can only handle 54 CFH at 80 ft
- The correct size is 1/2"

5. To size SECTION D, the distance from the meter to the range is 65 ft (A+B+D)

- Load is 50 CFH (50,000 BTUH).
- Table N-4 shows that size 3/8" can handle 58 CFH at 70 ft
- The correct size is 3/8"

6. To size SECTION E, the distance from the meter to the water heater is 30 ft (A+F)

- Load is 40 CFH (40,000 BTUH).
- Table N-4 shows that size 3/8" can handle 81 CFH at 70 ft
- The correct size is 3/8"

7. To size SECTION F, the distance from the meter to the furnace is 30 ft (A+E)

- Load is 80 CFH (80,000 BTUH).
- Table N-4 shows that size 3/8" can handle 81 CFH at 30 ft
- The correct size is 3/8"

8. To size SECTION G, the distance from the meter to the dryer is 35 ft (A+G)

- Load is 35 CFH (35,000 BTUH).
- Table N-4 shows that size 3/8" can handle 78 CFH at 40 ft
- The correct size is 3/8"

SECTION 3.2C — SIZING HYBRID SYSTEMS

(Black Iron and *TracPipe* Combination)

To size a commercial or a residential system with a rigid black iron trunk line and flexible *TracPipe* branches feeding the appliances, you will need both the standard gas piping capacity tables for black iron printed in many plumbing and mechanical codes (and contained in both National and International Fuel Gas Code) and the *TracPipe* Capacity Tables printed later in this manual.

NOTE: Black Iron pipe Capacity Table is provided in this Design Guide Section 7.2

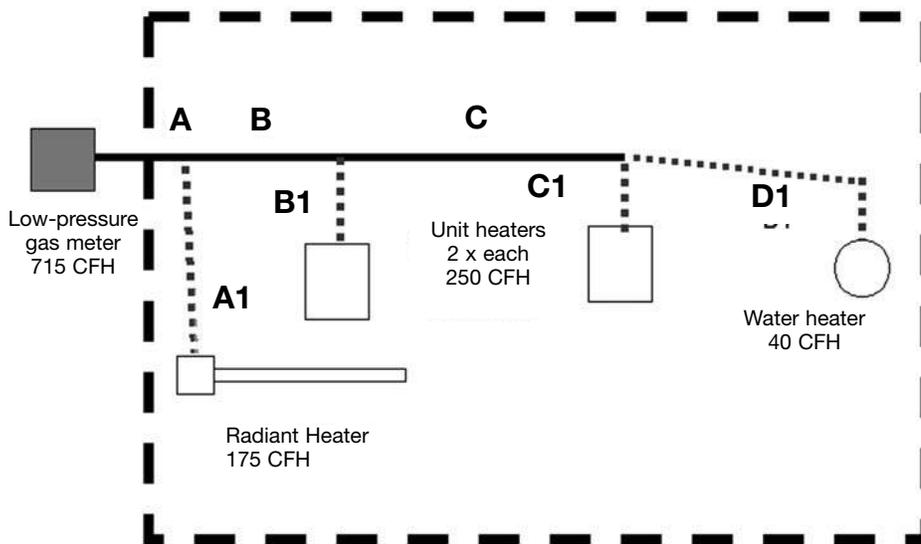

Figure 3-5

LENGTH OF RUNS

A = 15 Feet C = 20 Feet
 A1 = 45 Feet C1 = 5 Feet
 B = 15 Feet D1 = 20 Feet
 B1 = 10 Feet

EXAMPLE 5 LOW PRESSURE HYBRID SYSTEM (Black Iron and *TracPipe* Combination) SERIES ARRANGEMENT

1. The system shown in figure 3-5 is a typical commercial building with 4 appliances. The gas pressure for this example is standard low pressure with 6-inch supply pressure and 0.5-inch pressure drop.
2. To determine rigid pipe size (section A) determine the longest run from the meter to the furthest appliance:
 Meter to Water Heater Add A + B + C + D1 = 70 ft.

Total Load is 715 CFH (715,000 BTU)
 Section A correct size is 1 1/2 inch black pipe

3. To determine rigid pipe size (section B) reduce load by the load carried in section A1 to Radiant Heater (175 CFH). Use same number for length: 70 ft. is longest run. Load for this section is 540 CFH
 Section B correct size is 1 1/2 inch black pipe
4. To determine rigid pipe size (section C) reduce load further by the load carried in section B1 to first unit heater (250 CFH). Use same number for length: 70 ft. is longest run.
 Load for this section is 290 CFH
 Section C correct size is 1 1/4 inch black pipe

5. To determine *TracPipe* sizing for the branch runs the length to be used is the total length of black pipe plus *TracPipe* from the meter to that appliance. The load used is the load of the individual piece of equipment.

6. To determine the size of *TracPipe* (section D1) the length is 70 ft and the load is 40 CFH. Using Table N-1:
 Section D correct size is 3/4 inch

7. To determine the size of *TracPipe* (section C1) the length is 55 ft and the load is 250 CFH. Using Table N-1:
 Section C1 correct size is 1 1/2 inch
8. To determine the size of *TracPipe* (section B1) the length is 40 ft and the load is 250 CFH. Using Table N-1:
 Section B1 correct size is 1 1/4 inch
9. To determine the size of *TracPipe* (section A1) the length is 60 ft and the load is 175 CFH. Using Table N-1:
 Section A1 correct size is 1 1/4 inch

EXAMPLE 6 LOW PRESSURE HYBRID SYSTEM (Black Iron and *TracPipe* Combination) SERIES ARRANGEMENT

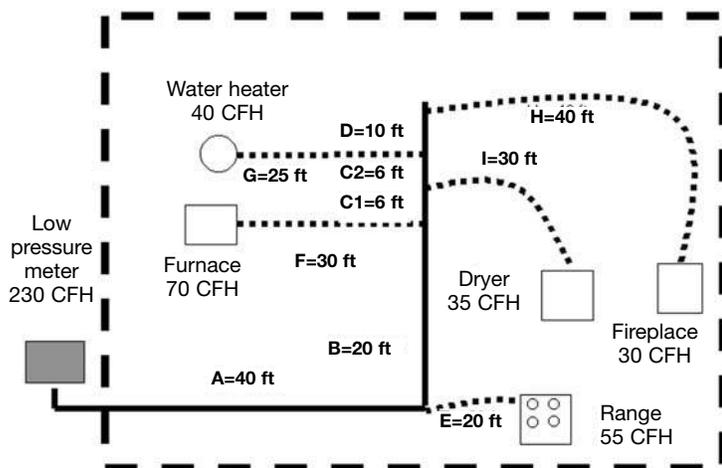

Figure 3-6

1. The system presented in figure 3-6 is a typical residence with 5 appliances. The supply pressure is 7 inches w.c. The allowable drop is 1-inch w.c. total. (black iron drop is 0.5 in. w.c. and **TracPipe** drop is 0.5 in. w.c.) Note: Check with your local inspection department and/or gas utility before sizing any low-pressure system with a total drop of more than 0.5 in. w.c.
2. The black iron trunk line (A+B+C1+C2+D) will first be sized for a drop of 0.5 in., w.c. in accordance with the standard method (longest total run) and each **TracPipe** branch run to an appliance will then be sized for 1.0 in w.c. drop based on the length from that appliance back to the meter. The maximum pressure drop to each appliance will be 1.0-inch w.c.
3. The longest total run is 120 ft. (total length of all black iron sections and **TracPipe** section to the furthest appliance). The total load is 70+40+55+35+30=230 CFH. Correct size for A is 1-1/4"
4. Section B, the longest run remains 120 ft but the load is reduced to 175 CFH. Correct size is 1".

5. Section C1, the longest run is 120 ft and load is reduced to 105. Correct size is 1".
6. Section C2, the longest run is 120 ft and load is reduced to 70. Correct size is 3/4".
7. Section D, the longest run is 120 ft and load is reduced to 30. Correct size is 1/2".
8. Section E, length is 60 ft and the load is 55 CFH. From Table N-1 the correct size is 3/4".
9. Section F, length is 90 ft and the load is 70 CFH. From Table N-1 the correct size is 3/4".
10. Section G, length is 95 ft and the load is 40 CFH. From Table N-1 the correct size is 3/4".
11. Section H, length is 120 ft and the load is 30 CFH. From Table N-1 the correct size is 3/4".
12. Section I, length is 95 ft and the load is 35 CFH. From Table N-1 the correct size is 3/4".

EXAMPLE 7 LOW PRESSURE HYBRID STEEL PIPE AND *TRACPIPE*-PARALLEL ARRANGEMENT-MANIFOLD-USING THE LONGEST RUN METHOD

1. The system presented in figure 3-7 is typical of a residential installation with four appliances. The supply pressure is 7-8 inches water column. The system will be sized with 0.5 inches w. c. drop for the steel pipe trunk line and 1 inch w.c. drop for the **TracPipe** branches. (Note: confirm that pressure drops larger than 0.5 inches water column are permitted in your jurisdiction)

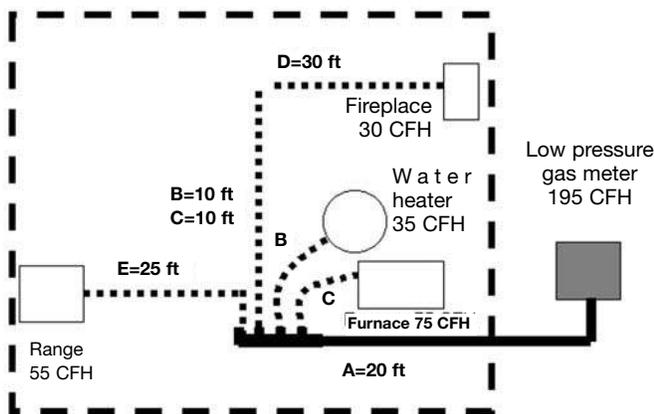

Figure 3-7

- To size the steel pipe trunk line, determine the longest run from the meter to any appliance and the total load. The longest run is to the fireplace.

- Meter to fireplace is 50 ft (A + D)
 - Total load is 195 CFH (75 + 35 + 30 + 55)
- Using steel pipe Table SP-1 (page 77) following the 50 ft column down, the correct size for the steel pipe is 1".

- To determine the size of the **TracPipe** run "C" to the furnace use the load through that branch (75 CFH) and calculate the length from the meter to the furnace.

- Meter to furnace is 30 ft (A + B)
 - Furnace load is 75 CFH
- Using Table N-2A the 1.0-inch w.c. pressure drop chart for **TracPipe**. Follow the 30 ft column down, the correct size for the furnace branch line "C" is 1/2".

- To determine the size of the **TracPipe** run "B" to the water heater use the load through that branch (35 CFH) and calculate the length from the meter to the water heater.

- Meter to water heater is 30 ft (A + C)
 - Water heater load is 35 CFH
- Using Table N-2A the 1.0-inch w.c. pressure drop chart for **TracPipe**. Follow the 30 ft column down, the correct size for the water heater branch line "B" is 1/2".

- To determine the size of the **TracPipe** run "D" to the fireplace use the load through that branch (30 CFH) and calculate the length from the meter to the fireplace.

- Meter to fireplace is 50 ft (A + D)
- Fireplace load is 30 CFH

Using Table N-2A the 1.0-inch w.c. pressure drop chart for **TracPipe**. Follow the 50 ft column down, the correct size for the fireplace branch line "D" is 1/2".

- To determine the size of the **TracPipe** run "E" to the range use the load through that branch (55 CFH) and calculate the length from the meter to the range.

- Meter to range is 45 ft (A + E)
 - Range load is 55 CFH
- Using Table N-2A the 1.0-inch w.c. pressure drop chart for **TracPipe**. Follow the 50 ft column down, the correct size for the range branch line "E" is 1/2".

SECTION 3.2D — ALTERNATE SIZING METHOD: SUM OF PRESSURE LOSS CALCULATIONS

- In addition to the longest run sizing method, there is another approach to pipe sizing, which yields results closer to the actual friction loss results (obtained from testing) for each section of an installed gas piping system. This engineered approach "Sum of Pressure Loss Calculations" avoids the simplified, conservative approximations of the longest run method. Mechanical engineers who design piping systems understand that placing a building's entire load (theoretically) at the farthest equipment outlet is not only inaccurate but will often yield pipe sizes which are larger than necessary. The longest run method was devised at a time when gas utilities could not always guarantee a constant pressure at every meter during times of high demands; it is a conservative approach and, although it is the customary sizing approach in North America, other engineered calculations are permitted by most codes.

2. Pressure Loss Calculations which sum up friction losses in each section of a gas piping system can provide a system design with more accurate and possibly smaller piping diameters than the traditional longest run method. These calculations utilize pressure loss charts for each size of CSST, which have been developed from actual test results. The maximum flow capacity is predicted with more precision than with the longest run method. The Sum of Pressure Loss method is described below with tables providing pressure loss per foot based upon the total load supplied by that length of pipe with all appliances operating.

3. The system designer has simply to determine the load and the length for each run. A tentative size is chosen and pressure loss in that leg is determined by multiplying the loss per foot (inches w.c. from the chart) by the length. Starting at the meter and working outward the pressure loss for each leg is then summed up until the farthest appliance is reached. The total calculated loss is then compared with the allowable loss, which must not be exceeded from the meter to the farthest appliance. The allowable pressure loss for each system is the responsibility of the system designer, based on model codes and on the available pressure at the meter set (or second stage regulator) and the pressure required for each appliance (usually found on the manufacturer's data plate.) Current language in many model codes states: The allowable loss under maximum probable flow conditions, from the point of delivery to the inlet connection of the appliance, shall be such that the supply pressure at the appliance is greater than the "minimum inlet pressure" as stated on the appliance manufacturer's data plate. If the initial proposed design calculation yields a total pressure loss, which is higher than allowed, simply go back and calculate again with larger sizes, starting from the meter.

USING SUM OF PRESSURE LOSS METHOD

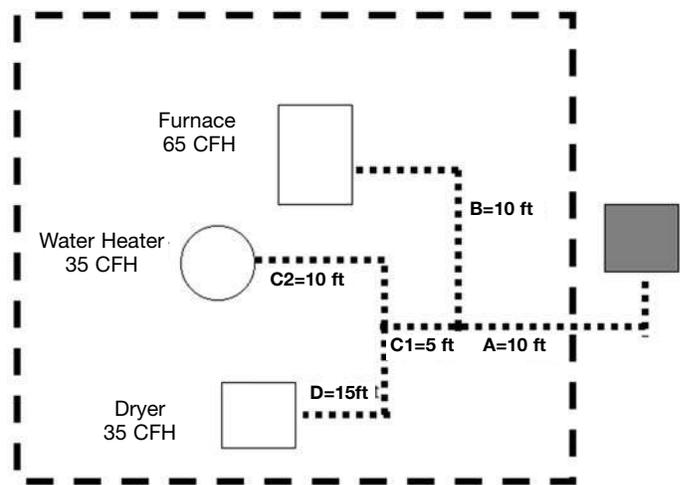

Figure 3-8

EXAMPLE 8 LOW PRESSURE SYSTEM SERIES ARRANGEMENT

- The system presented in figure 3-8 is similar to that in 3-1, a single-family installation with the addition of one more appliance, a dryer. The supply pressure is 6 inches water column and the allowable pressure drop is 1/2 inch.
- To size section A, calculate the load carried by that section:
 - Furnace plus Water Heater plus Dryer = 135 CFH (135,000 BTU)
 Using Table PD-1 find pressure loss at 135 MBTU load through 3/4" **TracPipe** Average of .019 and .022 is .021. Drop per foot is 0.021; multiply by length 10 feet = 0.21 drop
- To size section B find the drop per foot for the load carried by that section:
 - 65 CFH (MBTU)
 Using Table PD-1 find pressure loss at 65 MBTU through 1/2" **TracPipe** Use the average of loss between 60 and 70 MBTU: Average of .019 and .027 is .023 ; Drop per foot is 0.023 Multiply by length 10 feet = 0.23 drop
 Sum pressure loss meter to Furnace 0.21 + 0.23 = .44 inches w.c
 This leg is sized properly at 1/2" because sum of loss is less than .5 in. w.c.

4. To size section C1 find the drop per foot for the load carried by that section:
70 CFH (MBTU)
Using Table PD-1 find pressure loss at 70 MBTU load through 1/2" **TracPipe**
Drop per foot is .027; length is 5 ft; 5 X .027 is .135

5. To size section C2 find the drop per foot for the load carried by that section:
35 CFH (MBTU)
Using Table PD-1 find pressure loss at 35 CFH load through 1/2" **TracPipe**
Average of .008 and .004 is .006; length is 10 ft; 10X .006 is .06
Sum pressure loss to water heater $0.21 + .135 + .06 = .405$ inches w.c
This leg is sized properly at 1/2" because sum of loss is less than .5 in. w.c.

6. To size section D find the drop per foot for the load carried by that section:
35 CFH (MBTU)
Using Table PD-1 find pressure loss at 35 MBTU through 1/2" **TracPipe**
Drop per foot is .006 (see number 4 above); Multiply by length 15 feet = .09
Sum pressure loss to dryer $0.21 + 0.135 + .09 = .435$ inches w.c.
This leg is sized properly at 1/2" because sum of loss is less than .5 in. w.c.

The sum of pressure loss method allows the addition of an appliance without increasing trunk line size.

EXAMPLE 9 LOW PRESSURE HYBRID SYSTEM (Steel Pipe and *TracPipe* Combination) SERIES ARRANGEMENT USING SUM OF PRESSURE LOSS METHOD

1. The system presented in figure 3-9 is identical to that in Figure 3-6: a single-family installation with 5 appliances. Low pressure 6-7 inches and a pressure drop of 0.5 inches water column. NOTE: in

Example 6 this system was sized using the longest run method. Here we will use the sum of pressure loss method discussed in section 3.2D.

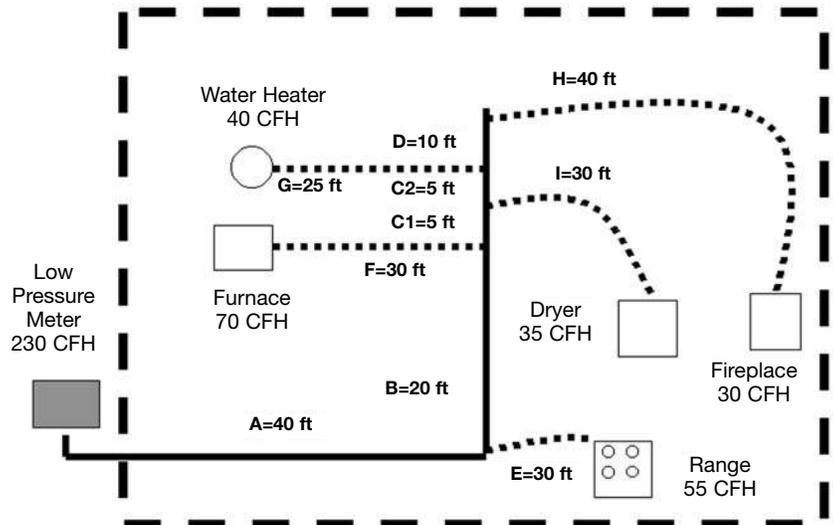

Figure 3-9

2. Begin by using pipe sizes determined in Example 6 and determine if these are correct with this method. It is possible that smaller pipe sizes may be sufficient; this will be determined by calculating the sum of pressure losses from the meter to each appliance. To use this method a tentative size will be assigned to each run and this size will be confirmed or revised by the calculation. The sum total loss of a run from the meter to the appliance cannot exceed the allowable pressure loss.
3. To determine pressure loss through section A (steel pipe trunk), use the load through that section (230 CFH) and find pressure loss per foot from the steel pipe Schedule 40 Pressure Drop Curves Graph Table SP-1. The 1 1/4 inch pipe diameter line intersects the 230 CFH line at a pressure drop of .18 inches w.c. per 100 feet of length. Multiply the length: 40 feet by the loss per foot: 0.0018. The pressure loss for this section is 0.072.
4. To determine pressure loss through section B we use the load through that section (175 CFH). Find pressure loss for 1" size from the steel pipe graph in Table SP-1 - 0.6 per 100 feet. Multiply the length: 20 feet by the loss per foot: 0.006. The pressure loss for this section is 0.12.

5. To determine pressure loss through section C1 we use the load through that section (105 CFH). Find pressure loss for 1" size from the steel pipe graph - 0.2 per 100 feet. Multiply the length: 5 feet by the loss per foot: 0.002. The pressure loss for this section is 0.01.
6. To determine pressure loss through section C2 we use the load through that section (70 CFH). Find pressure loss for 3/4" size from the steel pipe graph - 0.38 per 100 feet. Multiply the length: 5 feet by the loss per foot: 0.0038. The pressure loss for this section is 0.019.
7. To determine pressure loss through section D we use the load through that section (30 CFH). Find pressure loss for 1/2" size from the steel pipe graph - 0.31 per 100 feet. Multiply the length: 10 feet by the loss per foot: 0.0031. The pressure loss for this section is 0.031.
8. To determine pressure loss through section E (**TracPipe** drop to the range), use the load through that section (55 CFH) and find pressure loss from Table PD-1 Pressure Drop per Foot for **TracPipe**. Trying the 3/4 inch column we find .004 inches per foot length (there is no 55 CFH load listed, so we use 60 CFH). Multiply the length: 30 feet by the loss per foot .004. The pressure loss for this section is 0.12. Add the loss of section A to the loss of section E for total loss from the meter to range. $0.072 + 0.12 = 0.192$. Since this is less than the 0.5 allowable drop the correct size for section E is 3/4".
9. To determine pressure loss through section F (**TracPipe** drop to the furnace), use the load (70 CFH) and find pressure loss from Table PD-1. In the 3/4" column we find 0.005. Multiply the length: 30 feet by 0.005. The pressure loss for this section is 0.15.
Add the loss of sections A + B to the loss of section F for total loss from meter to furnace. $0.072 + 0.12 + 0.15 = 0.342$. The correct size for section F is 3/4".
10. To determine pressure loss through section G (**TracPipe** drop to the water heater), use the load (40 CFH) and find pressure loss from Table PD-1. In the 1/2" column we find 0.008. Multiply the length: 25 feet by 0.008. The pressure loss for this section is 0.20. Add the loss of sections A + B + C1 + C2 to the loss of section G for total loss from meter to furnace. $0.072 + 0.12 + 0.01 + 0.019 + 0.20 = 0.421$. The correct size for section G is 1/2".
11. To determine pressure loss through section H (**TracPipe** drop to the fireplace), use the load (30 CFH) and find pressure loss from Table PD-1. In the 1/2" column we find 0.004. Multiply the length: 40 feet by 0.004. The pressure loss for this section is 0.16. Add the loss of sections A + B + C1 + C2 + D to the loss of section H for total loss from meter to furnace. $0.072 + 0.12 + 0.01 + 0.019 + 0.031 + 0.16 = 0.412$. The correct size for section H is 1/2".
12. To determine pressure loss through section I (**TracPipe** drop to the dryer), use the load (35 CFH) and find pressure loss from Table PD-1. In the 1/2" column we find 0.006. Multiply the length: 30 feet by 0.006. The pressure loss for this section is 0.18. Add the loss of sections A + B + C1 to the loss of section I for total loss from meter to dryer. $0.072 + 0.12 + 0.01 + 0.18 = 0.382$. The correct size for section I is 1/2". Using the Sum of Pressure Loss Method we calculate that three of the five **TracPipe** sections (when compared with the longest length method) can utilize reduced sizes to deliver the necessary load with a pressure loss equal to or less than the allowable 0.5 inches water column. This enables the installer to use 1/2" **TracPipe** on all but the furnace and range drops, which remain 3/4".

SECTION 3.3 AUTOTRIP™ LOW PRESSURE EXCESS FLOW VALVES FOR NATURAL GAS AND PROPANE SERVICE

An excess flow valve (EFV) is a protective device to help control the discharge of fuel gas in the event of a complete breakage of pipe lines or flex connector rupture. Excess flow valves have been of help in limiting gas loss in many incidents involving breakage of piping; thus they do provide a useful safety function in gas systems. This section explains what protection excess flow valves can offer, points out conditions which can interfere with that protection, and offers suggestions for effective excess flow valve installation.

1. There are two types of AutoTrip EFVs: LFD Series Line/Meter excess flow valves and AFD Series Appliance Connector excess flow valves.



LFD Series

A. **AutoTrip LFD Line/Meter Excess Flow Valves (EFVs)** protect against potential damage due to the release of fuel gas as a result of residential and commercial gas line breaks. AUTOTRIP excess flow valves work in conjunction with all approved gas piping materials (*TracPipe*®, other brands of CSST, steel pipe, and copper tube) at the gas meter, second stage regulator, the appliance branch line or manifold connection.

B. **AutoTrip AFD Appliance Connector Excess Flow Valves** protect against potential damage due to the release of fuel gas when a flexible gas appliance connector line breaks.

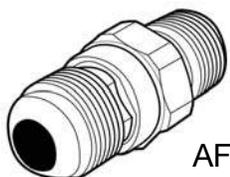

AFD Series

AUTOTRIP Appliance Connector EFVs act to restrict the flow of gas should the downstream appliance connector suffer a complete break or pull-out. The inlet side of the AUTOTRIP Appliance Connector excess flow valve adapts to all approved gas piping materials (*TracPipe*®, other brands of CSST, steel pipe, and copper tube) with an NPT connection. The Outlet side comes equipped with an SAE flare for connection to standard appliance connectors.

2. Quality Assurance

- AutoTrip valves are Design-Certified by CSA International and manufactured and 100% factory tested in accordance with the IAS U.S. Requirements 3-92 for Excess Flow Valves
- Listed by IAPMO File 5031-International Association of Plumbing and Mechanical Officials
- Listed by CA-DSA-California Division of State Architect

3. IMPORTANT NOTES and LIMITATIONS Regarding the Use of Excess Flow Valves

Installation of the AutoTrip excess flow valve must only be performed by a qualified plumber or gas fitter who meets state and/or local requirements to perform work on fuel gas piping systems. The AutoTrip valve must be installed in compliance with local codes or, in the absence of local codes, with the National Fuel Gas Code ANSI Z223.1/NFPA 54, The International Fuel Gas Code, or The Uniform Plumbing Code.

IMPORTANT

1. **DANGER:** Read all installation instructions and limitations before installing.
2. Size the excess flow valve to match the gas demand for appliances installed. See sizing instructions below. **DO NOT OVERSIZE** the valve for anticipated appliance additions.
3. Prior to installing, **TURN OFF** gas supply using an upstream shut-off valve.
4. Install the excess flow valve with the proper flow direction as marked on the label and in the correct position (vertical up only for LFD models) and (multipoise [any position] for AFD models) as specified in these instructions.
5. After installation is complete, pressurize system by opening gas supply shut off valve **VERY SLOWLY** to initiate gas service.
6. Check all connections with a non-corrosive leak detector solution to assure connections are leak tight. (Available: TracPipe Leak Check Solution P/N FGP-LCS)

4. LIMITATIONS OF AUTOTRIP EXCESS FLOW VALVES FOR NATURAL GAS AND PROPANE SYSTEMS

AUTOTRIP excess flow valves are designed to protect against complete breakage of gas lines **DOWNSTREAM** of the location of which the AUTOTRIP excess flow valve is installed. AUTOTRIP excess flow valves installed at the Meter are designed only to protect the main trunk line piping of like size of which it was installed. These devices may not protect against gas piping breaks at a given length downstream from the EFV or after a reduction in pipe size. Additional factors that may affect the proper function of an EFV:

1. The system was not sized properly to allow the EFV to close upon complete breakage of a gas line
2. The system was not sized properly with the EFV to allow proper operation of all appliances
3. The supply pressure is not great enough to provide the required capacity
4. Restrictions exist in the gas piping system that prevent proper operation of the EFV such as, but not limited to, reductions in pipe size, incomplete or partial breaks of gas lines, partially open or smaller than full-bore valves or components in the gas piping system, any additional restrictions that would prevent the required capacity of gas to escape from the system that would close the valve.
5. Foreign matter, such as pipe thread sealant, is lodged in valve, preventing closure.
6. The excess flow valve has been damaged by fire or improper installation and is no longer in operating condition. **NOTE: If the valve is not in operating condition, IT MUST BE REPLACED.**

SECTION 3.4 AUTOTRIP LFD SERIES EXCESS FLOW VALVES FOR METER AND BRANCH LINE/MANIFOLD APPLICATIONS

LFD SERIES PRODUCT SPECIFICATIONS

Material Specification:

Body	Brass Nickel Plated
Seat & Retainer	Polyamide
Valve Float / Ball	POM or PTFE
<u>Operating Temperature:</u>	-20°F to 150°F
<u>Operating Pressure:</u>	0.18 psig (5"wc) to 2 psig
<u>Maximum Bypass Flow:</u>	10 CFH (Air equivalent)

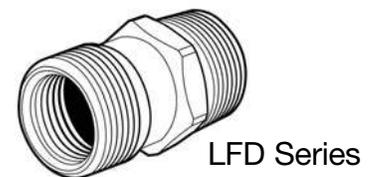

For additional product information including Model Numbers, inlet/outlet thread connections, Maximum load capacity and flow rates, & application please reference Table 3.1 below.

3.4.1 APPLICATION, AND SELECTION OF AUTOTRIP LFD SERIES EXCESS FLOW VALVES

1. Application. Determine the Type of EFV based on the application (Ref. Figure 3.10)
 - a) Meter
 - b) Branch Line
2. EFV Model Selection. From TABLE 3.1, select the appropriate AUTOTRIP LFD Series EFV(s) based on the TOTAL BTU/hr load capacity of the appliance(s) it serves. *For a Meter application, this is the TOTAL BTU/hr load capacity of ALL the appliance(s) served by the gas meter. For a Branch Line application, this is the BTU/hr load capacity of the appliance(s) on the branch for which the AUTOTRIP*

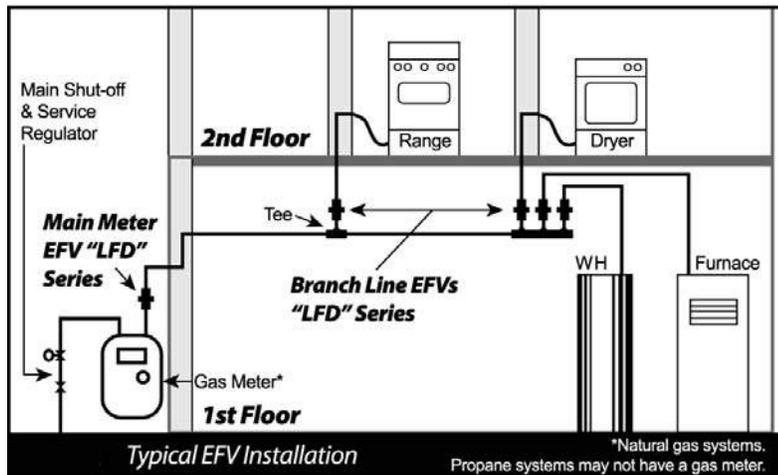

FIGURE 3-10

EFV is installed. The TOTAL BTU/hr load capacity of the appliance(s) should be equal to or less than the Maximum Load Capacity (BTU/hr) value of the AUTOTRIP LFD Series EFV selected from TABLE 3.1.

**TABLE 3.1
AUTOTRIP LFD Series Excess Flow Valves Application Data**

EFV Type - Application	OmegaFlex AUTOTRIP P/N	Mounting Position	Inlet Thread Connection(s)	Outlet Thread Connection(s)	Maximum Load Capacity (BTU/hr)	Nominal Closure Flow Rate (SCFH)
Appliance Branch Line	FGP-LFD-70	Vertical Up ONLY	3/4" M-NPT & 1/2" F-NPT	3/4" M-NPT & 1/2" F-NPT	70,000	97
Appliance Branch Line	FGP-LFD-125	Vertical Up ONLY	3/4" M-NPT & 1/2" F-NPT	3/4" M-NPT & 1/2" F-NPT	125,000	147
Meter / Branch Line	FGP-LFD-275A	Vertical Up ONLY	3/4" M-NPT & 1/2" F-NPT	3/4" M-NPT & 1/2" F-NPT	275,000	335
Meter / Branch Line	FGP-LFD-275B	Vertical Up ONLY	1" M-NPT & 3/4" F-NPT	1" M-NPT & 3/4" F-NPT	275,000	335
Meter / Branch Line	FGP-LFD-375	Vertical Up ONLY	1" M-NPT & 3/4" F-NPT	1" M-NPT & 3/4" F-NPT	375,000	460
Meter / Branch Line	FGP-LFD-500	Vertical Up ONLY	1 1/4" M-NPT & 1" F-NPT	1 1/4" M-NPT & 1" F-NPT	500,000	685

Notes:

- 1) Flow Rates given for 0.60 Specific Gravity Natural Gas with an Avg. Heating Value of 1000 BTU / cubic foot.
- 2) To convert Maximum Load Capacity value to BTU/hr Propane (1.52 Specific Gravity, 2520 BTU / cubic foot), multiply Natural Gas Value by 1.583.
- 3) To convert SCFH Nominal Closure Flow Rate to SCFH Propane, multiply Natural gas Value above by 0.628
- 4) Abbreviations: w.c. = inches water column
SFCH = Standard Cubic Feet per Hour

3.4.2 GAS PIPING SYSTEM SIZING WITH LFD SERIES EXCESS FLOW VALVES

AUTOTRIP LFD Series excess flow valves must be sized properly for the gas piping system in which they are installed. When installing AUTOTRIP excess flow valves within a fuel gas piping system, the user must assure that:

1. The AUTOTRIP LFD Series EFV will close upon a complete breakage or rupture of gas piping at an expected length downstream of the EFV. It is recommended that the installer conduct tests on the gas piping system to ensure the EFV(s) will function as intended. Note: Tests should be performed in accordance with all applicable local and national codes.
2. The addition of the AUTOTRIP LFD Series EFV will allow all appliances to which the EFV serves to operate properly without the undue loss of pressure. It is recommended that the installer run all appliances with the EFV(s) installed to assure proper operation.

3.4.3 METHODS OF SIZING

STANDARD SIZING METHOD - When sizing a gas piping system including AutoTrip LFD Series EFVs, size the gas piping system using the following Tables (N-1AT, N-3AT, N-5AT, SP-1AT, P-1AT) using standard methods of gas pipe sizing – Branch Length or Longest Run Method.

ALTERNATE SIZING METHOD – If using an Engineered Method, i.e. “Sum of Pressures Method” of gas pipe sizing, use the pressure drop values in Figure 3.12 in your gas piping calculations.

3.4.4 SIZING INSTRUCTIONS FOR AUTOTRIP LFD SERIES EFVS USED WITH TRACPIPE CSST SYSTEMS

- A. Meter Applications (LFD Series LFD-275A, LFD-275B, LFD-375, LFD-500)
 1. Choose the appropriate AutoTrip LFD Series Meter EFV using TABLE 3.1 based on the total capacity of the gas piping system served by that meter.
 2. Using the appropriate AutoTrip Capacity Chart “Table N-1AT AutoTrip Low Pressure” or “Table N-5AT AutoTrip (2-psi system)” based upon system pressure; determine the size of CSST based on the AutoTrip EFV selected in Step 1 and the appropriate sizing length. This size of CSST is designed to allow the AutoTrip EFV to act as a safety shut-off valve in the event of a complete breakage of the main trunk line piping.
- B Branch Line / Manifold Applications (LFD Series LFD-70, LFD-125, LFD-275A, LFD-275B, LFD-375, and LFD-500)
 1. Elevated Pressure 2 PSI system (Manifold with parallel arrangement)
 - a. Choose the appropriate size AutoTrip LFD Series Appliance Branch Line EFV using TABLE 3.1 based on the capacity for each manifold outlet. Select an EFV with sufficient capacity to supply the appliance(s) connected to the outlet.
 - b. Using AutoTrip Capacity Chart “Table N-3AT AutoTrip Dual Pressure System” determine size of TracPipe CSST based on the AutoTrip EFV selected in Step a and the appropriate sizing length from the manifold to the appliance(s). This size of CSST is designed to allow the AutoTrip EFV to act as a safety shut-off valve in the event of the complete breakage of the downstream branch pipe line or flex connector rupture.

2. Series System Low Pressure
 - a. When there is no manifold, the EFV should be located at the tee or fitting where the appliance drop attaches to the trunk line. If this is a concealed location, follow local codes.
 - b. Choose the appropriate size AutoTrip LFD Series Appliance Branch Line EFV using TABLE 3.1 based on the capacity for that branch line. Select an EFV with sufficient capacity to supply the appliance(s) connected to that drop.
 - c. Using AutoTrip Capacity Chart “Table N-1AT AutoTrip Low Pressure” determine size of TracPipe CSST based on the AutoTrip EFV selected in Step b and the appropriate sizing length from the appliance back to the meter. This size of CSST is designed to allow the AutoTrip EFV to act as a safety shut-off valve in the event of a complete breakage of the downstream branch pipe line or flex connector rupture.

3.4.5 SIZING INSTRUCTIONS FOR AUTOTRIP LFD SERIES EFVS USED WITH LOW PRESSURE STEEL PIPE SYSTEMS

1. Choose the AutoTrip LFD Series EFV (Appliance branch line or Meter) using TABLE 3.1 which will supply the necessary capacity of the meter or appliance(s) it serves.
2. Using AutoTrip Capacity Chart “Table SP-1AT AutoTrip Steel Pipe Low Pressure” determine the size of steel pipe based on the AutoTrip EFV selected in Step 1 and the appropriate sizing length. This size of steel pipe is designed to allow the AutoTrip EFV to act as a safety shut-off valve in the event of a complete breakage of the main trunk line piping (Meter EFV) or of the downstream branch pipe line or flex connector rupture (Appliance Branch Line EFV).

3.4.6 LFD INSTALLATION INSTRUCTIONS

- A. Installation of AUTOTRIP LFD Series Meter Application excess flow valves downstream of the Gas Meter Outlet

The AUTOTRIP device can be installed downstream of the gas company meter and bypass tee outlet using standard pipe fittings and procedures. AUTOTRIP Meter Valves-LFD models must be installed within 5 degrees of the vertical position with the flow arrow pointing upward in the direction of flow. Note: EFVs installed at the Meter are designed only to protect the main trunk line of like pipe size downstream of the EFV.

- B. Installation of AUTOTRIP LFD Series Branch Line excess flow valves at the Tee or Manifold connection of a Branch Line to an Appliance

AUTOTRIP Branch Line excess flow valves should be connected directly to the manifold outlet at the point between the manifold and the gas appliance lines. If there is no manifold, the valves could be located at the tee or fitting where the appliance drop attaches to the trunk line. AUTOTRIP Branch Line excess flow valves must be installed in the vertical position (within 5 degrees) with the flow arrow pointing upward in the direction of flow.

- C. **Step-by-Step Installation Instructions**
 1. Prior to installing the AUTOTRIP excess flow valve (EFV), turn gas supply off upstream of the EFV using appropriate shut-off valve. For a Meter EFV installation, this will be the main gas company shut-off valve.
 2. Install AUTOTRIP EFV into piping system at desired location using appropriate pipe fittings and tools. When using a thread sealant on pipe threads, do not allow the sealant, Teflon tape or any debris to enter the valve. Foreign matter can lodge in the valve and prevent proper operation.

3. After AUTOTRIP EFV is installed, insure all connections in the gas piping system are gas tight.
4. Re-open upstream shut-off valve SLOWLY to re-pressurize the system. NOTE: If upstream shut-off valve is opened too quickly and an excess flow condition is created due to a pressure surge the AUTOTRIP EFV may trip (close). If this occurs, reset the valve using the Resetting an AUTOTRIP EFV instructions below.

5. **Resetting an AUTOTRIP EFV that has “tripped” (closed).** Turn gas supply off upstream of the EFV using appropriate shut-off valve. For a Meter EFV installation, this will be the main gas company shut-off valve. Repair all damaged piping as required. Reset the AutoTrip EFV by closing and sealing off all downstream connections. Once the

pressure in the upstream and downstream piping is equalized, the EFV will reset. This is evident by a “soft click” that can be heard from the AutoTrip EFV. Typical time to reset is 1-2 minutes or of greater duration for larger diameter and/or longer lengths of downstream piping. Repeat Step 4. above to re-pressurize the system.

NOTE: If there are any open connections (assure all appliance valves are shut) or leaks downstream of the AUTOTRIP EFV, the EFV will not reset!

CAUTION: Installer must assure at all times that any gas that may have escaped from the gas piping system as a result of a pipe break, valve testing, leakage, etc. is completely dissipated prior to opening appliance shut-offs and firing of appliances. Assure that there is no electrical or motorized equipment in use during this process.

SECTION 3.5 - AUTOTRIP AFD SERIES EXCESS FLOW VALVES FOR APPLIANCE CONNECTOR INLET APPLICATIONS

AFD SERIES PRODUCT SPECIFICATIONS

Material Specification:

Body	Brass Nickel Plated
Seat	Polyamide
Valve Float	Polyamide
Spring	Stainless Steel
<u>Operating Temperature:</u>	32°F to 150°F
<u>Operating Pressure:</u>	0.18 psig (5"wc) to 1/2 psig
<u>Maximum Bypass Flow:</u>	10 CFH (Air equivalent)



For additional product information including Model Numbers, inlet/outlet thread connections, Maximum load capacity and flow rates, & application please reference Table 3.3 below.

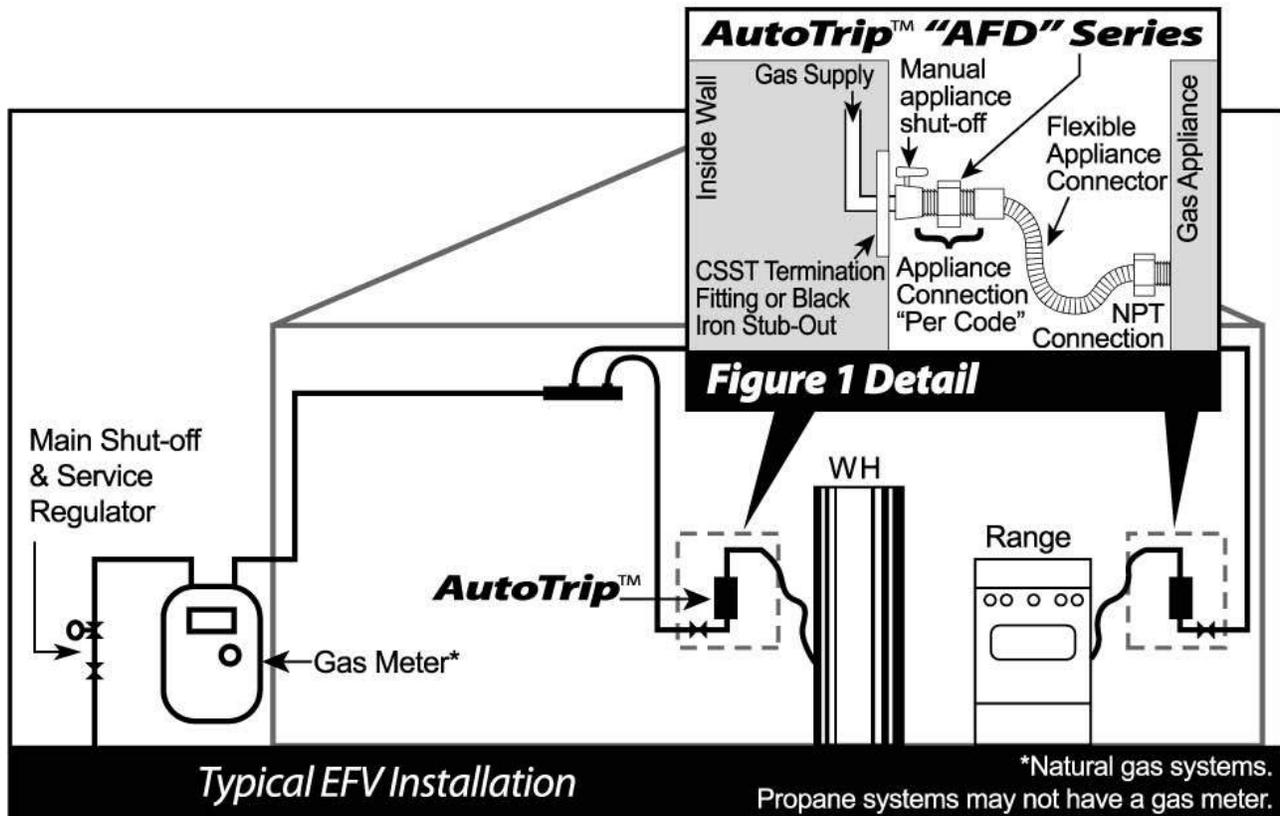

FIGURE 3-11

3.5.1 APPLICATION AND SELECTION OF AUTOTRIP AFD SERIES EXCESS FLOW VALVES

1. Application. Determine the Type of EFV based on the application – for the AFD Series the application will be to install the EFV at the inlet to a flexible appliance connector.
2. AFD Series EFV Model Selection. From TABLE 3.2, select the appropriate AUTOTRIP AFD EFV based on:
 - A. The BTU/hr load capacity of the appliance it serves. (Note: AUTOTRIP Appliance Connector EFVs will serve only the appliance for which the flexible appliance connector is installed to). The TOTAL BTU/hr load capacity of the appliance should be equal to or less than the Maximum Load Capacity (BTU/hr) value of the AUTOTRIP AFD EFV in TABLE 3.2.

- B. Inlet side NPT and Outlet side SAE Flare connections, Nominal ID of the appliance connector being used.

3 Gas Piping System Sizing with an AUTOTRIP AFD Series excess flow valve(s).

AUTOTRIP excess flow valves must be sized properly for the gas piping system in which they are installed. When installing AUTOTRIP excess flow valves within a fuel gas piping system, the user must assure that:

- A. The AUTOTRIP excess flow valve will close upon a complete breakage or rupture of the gas appliance connector piping downstream of the EFV. It is recommended that the installer conduct tests on the gas piping system to ensure the EFV(s) will function as intended. Note: Tests should be performed in accordance with all applicable local and national codes.

- B. The addition of the EFV will allow the appliance to which the EFV serves to operate properly without the undue loss of pressure. It is recommended that the installer run all appliances with the EFV(s) installed to assure proper operation.

Based on the upstream gas piping system sizing and downstream appliance connector sizing, the user must assure that the addition of the AFD Series EFV will not reduce the inlet pressure to the appliance below the minimum required for proper operation.

NOTE: AFD Series EFVs will add a Nominal 0.5 "wc pressure drop when operating at the Maximum Load Capacity (BTU/hr) of the EFV.

3.5.2 INSTALLATION INSTRUCTIONS

- A. Installation of AUTOTRIP Appliance Connector excess flow valves to the Flare connection of a Flexible Appliance Connector

AUTOTRIP Appliance Connector excess flow valves should be connected to the SAE Flare connection on the inlet side of an approved flexible appliance connector. AUTOTRIP Appliance Connector excess flow valves are designed for multipoise installation so they may be installed in the vertical, horizontal, or any angle from the horizontal, positions. **NOTE:** Appliance Connector AUTOTRIP excess flow valves are designed to protect against a complete breakage or pull-out of the flexible appliance connector only. This device will not protect gas piping upstream of the device.

B. Step-by-Step Installation Instructions

1. Prior to installing the AUTOTRIP excess flow valve (EFV), turn gas supply off upstream of the EFV using appropriate shut-off valve. If the appliance shut-off valve is installed upstream of the appliance connector, this valve may be used as the shut-off.

**TABLE 3.2
AUTOTRIP "AFD" Series Appliance Connector Inlet Excess Flow Valves Application Data**

EFV Type - Application	OmegaFlex AUTOTRIP P/N	Fits Nominal Appliance Connector ID Size	Mounting Position	Inlet Thread Connection(s)	Outlet Thread Connection(s)	Maximum Load Capacity (BTU/hr)	Nominal Closure Flow Rate (SCFH)
Appliance connector	FGP-AFD-80	1/4"	Multipoise	1/2" M-NPT & 3/8" F-NPT	3/8" SAE Flare	80,000	110
Appliance connector	FGP-AFD-100A	3/8"	Multipoise	1/2" M-NPT & 3/8" F-NPT	1/2" SAE Flare	100,000	175
Appliance connector	FGP-AFD-130A	1/2"	Multipoise	1/2" M-NPT & 3/8" F-NPT	5/8" SAE Flare	130,000	200
Appliance connector	FGP-AFD-130B	1/2"	Multipoise	3/4" M-NPT & 1/2" F-NPT	5/8" SAE Flare	130,000	200

Notes:

- 1) Flow Rates given for 0.60 Specific Gravity Natural Gas with an Avg. Heating Value of 1000 BTU / cubic foot.
- 2) To convert Maximum Load Capacity value to BTU/hr Propane (1.52 Specific Gravity, 2520 BTU / cubic foot), multiply Natural Gas Value by 1.583.
- 3) To convert SCFH Nominal Closure Flow Rate to SCFH Propane, multiply Natural gas Value above by 0.628
- 4) Abbreviations: "w.c. = inches water column
SCFH = Standard Cubic Feet per Hour

2. Install AUTOTRIP EFV at the inlet to the flexible appliance connector using appropriate pipe fittings and tools. When using a thread sealant on pipe threads, do not allow the sealant, Teflon tape or any debris to enter the valve. Foreign matter can lodge in the valve and prevent proper operation.
3. After AUTOTRIP EFV is installed, insure all connections in the gas piping system are gas tight.
4. Re-open upstream shut-off valve SLOWLY to re-pressurize the system. NOTE: If upstream shut-off valve is opened too quickly and an excess flow condition is created due to a pressure surge the AUTOTRIP EFV may trip (close). If this occurs, reset the valve using the Resetting an AUTOTRIP EFV instructions below.
- 5 **Resetting an AUTOTRIP EFV that has “tripped” (closed).** Repair all damaged piping as required. Reset the AUTOTRIP EFV by closing and sealing off all downstream connections. Once the pressure in the downstream piping is equalized, valve will reset. This is evident by a “soft click” that can be heard from the AUTOTRIP EFV. Typical time to reset is 15-30 seconds or of greater duration for larger diameter or longer length appliance connectors.

NOTE: If there are any open connections (assure all appliance valves are shut) or leaks downstream of the AUTOTRIP EFV, valve will not reset!

NOTE: Resetting AUTOTRIP Appliance Connector EFVs with appliance shut-off valve installed UPSTREAM of the EFV – These valves may be reset by closing and SLOWLY re-opening the upstream appliance shut-off valve without “tripping” the EFV.

CAUTION: Installer must assure at all times that any gas that may have escaped from the gas piping system as a result of a pipe

break, valve testing, leakage, etc. is completely dissipated prior to opening appliance shut-offs and firing of appliances. Assure that there is no electrical or motorized equipment in use during this process.

SECTION 3.6 GASBREAKER® EXCESS FLOW VALVES

GasBreaker® excess flow valves (EFV) protect against residential and commercial gas line breaks. GasBreakers work in conjunction with **TracPipe**, other brands of CSST or rigid gas piping at the gas meter, second stage regulator, the appliance branch line or manifold connection. GasBreaker EFVs are available in several different sizes and load capacity ratings.

1. The GasBreaker EFV can be installed downstream of the gas company meter and bypass tee outlet using standard pipe fittings and procedures. GasBreaker EFVs must be installed within 5 degrees of the vertical position with the flow arrow pointing upward in the direction of flow.
2. Use Table 3.4 for GasBreaker EFV capacity information and to determine the equivalent AutoTrip LFD excess flow valve. For sizing of the **TracPipe** CSST system with GasBreaker EFV’s utilize the equivalent AutoTrip capacity chart data.

TABLE N-1AT AUTOTRIP-TRACPIPE (Low Pressure System)
Determine TracPipe CSST size based upon the AutoTrip "LFD" Series EFV Chosen and Length of CSST Run
Regulator Outlet for 2-psi system (8 in w.c. with a Piping Pressure Drop of 3 in w.c.)

Distance Range – Length in Feet

AutoTrip P/N	Max. Capacity BTU	0-10 Feet	<15	<20	<25	<40	<50	<60	<90	<100	<150	<200	<250	<300
Appliance Branch Line Series														
FGP-LFD-70	70,000	1/2"	3/4"	3/4"	3/4"	3/4"	3/4"	3/4"	3/4"	1"	1"	1"	1"	1-1/4"
FGP-LFD-125	125,000	3/4"	3/4"	3/4"	3/4"	1"	1"	1"	1"	1-1/4"	1-1/4"	1-1/2"	1-1/2"	1-1/2"
Meter / Line Series														
FGP-LFD-275A or -275B	275,000	1"	1-1/4"	1-1/4"	1-1/4"	1-1/4"	1-1/2"	1-1/2"	1-1/2"	1-1/2"	1-1/2"	1-1/2"	2"	2"
FGP-LFD-375	375,000	1"	1-1/4"	1-1/4"	1-1/2"	1-1/2"	1-1/2"	1-1/2"	1-1/2"	1-1/2"	2"	2"	2"	2"
FGP-LFD-500	500,000	1-1/4"	1-1/2"	1-1/2"	1-1/2"	1-1/2"	1-1/2"	1-1/2"	2"	2"	2"	2"	2"	2"

NOTE: If you are installing a brand of CSST other than TracPipe, size each run to supply the Max Capacity of the AutoTrip device instead of the capacity of appliances on that run.

TABLE N-3AT AUTOTRIP-TRACPIPE (Dual Pressure System-8 in w.c. -Regulator outlet @ manifold)
Determine TracPipe CSST size based upon the AutoTrip "LFD" Series EFV Chosen and Length of CSST Run
Regulator Outlet for 2-psi system (8 in w.c. with a Piping Pressure Drop of 3 in w.c.)

Distance Range – Length in Feet

GasBreaker P/N	Max. Capacity BTU	0-10 Feet	<15	<20	<25	<30	<40	<50	<60	<80	<90	<100	<150	<200	<250	<300
Appliance Branch Line Series																
FGP-LFD-70	70,000	3/8"	3/8"	3/8"	1/2"	1/2"	1/2"	1/2"	1/2"	1/2"	1/2"	1/2"	3/4"	3/4"	3/4"	3/4"
FGP-LFD-125	125,000	1/2"	1/2"	1/2"	1/2"	1/2"	3/4"	3/4"	3/4"	3/4"	3/4"	3/4"	3/4"	1"	1"	1"
Meter / Line Series																
FGP-LFD-275A or -275B	275,000	3/4"	3/4"	3/4"	3/4"	1"	1"	1"	1"	1"	1-1/4"	1-1/4"	1-1/4"	1-1/4"	1-1/4"	1-1/2"
FGP-LFD-375	375,000	3/4"	3/4"	1"	1"	1"	1"	1"	1-1/4"	1-1/4"	1-1/4"	1-1/2"	1-1/2"	1-1/2"	1-1/2"	1-1/2"
FGP-LFD-500	500,000	1"	1"	1"	1-1/4"	1-1/4"	1-1/4"	1-1/4"	1-1/4"	1-1/2"	1-1/2"	1-1/2"	1-1/2"	1-1/2"	1-1/2"	1-1/2"

NOTE: If you are installing a brand of CSST other than TracPipe, size each run to supply the Max Capacity of the AutoTrip device instead of the capacity of appliances on that run.

TABLE N-5AT AUTOTRIP - TRACPIPE (2-psi system)
Determine TracPipe CSST size based upon the AutoTrip "LFD" Series EFV Chosen and Length of CSST Run
Meter Outlet for 2-psi system (Elevated Pressure) – Piping Pressure Drop 1-psi

Distance Range – Length in Feet

GasBreaker P/N	Max. Capacity BTU	Distance Range – Length in Feet														
		0-10 Feet	<25	<30	<40	<50	<75	<80	<100	<150	<200	<250	<300	<400	<500	
Meter / Line Series																
FGP-LFD-275A or -275B	275,000	3/8"	1/2"	1/2"	1/2"	1/2"	3/4"	3/4"	3/4"	3/4"	3/4"	3/4"	3/4"	3/4"	1"	1"
FGP-LFD-375	375,000	1/2"	1/2"	3/4"	3/4"	3/4"	3/4"	3/4"	3/4"	3/4"	3/4"	1"	1"	1"	1"	1"
FGP-LFD-500	500,000	1/2"	3/4"	3/4"	3/4"	3/4"	3/4"	3/4"	1"	1"	1"	1"	1"	1"	1-1/4"	1-1/4"

NOTE: If you are installing a brand of CSST other than TracPipe, size each run to supply the Max Capacity of the AutoTrip device instead of the capacity of appliances on that run.

TABLE SP-1AT AUTOTRIP - STEEL PIPE LOW PRESSURE
Determine pipe size based upon the AutoTrip "LFD" Series EFV Chosen and Length of Run
Standard Low Pressure 0.5 psi or less (7 in w.c.)—Piping Pressure Drop 0.5 in w.c.

Distance Range – Length in Feet

GasBreaker P/N	Max. Capacity BTU	Distance Range – Length in Feet														
		0-10 Feet	<20	<30	<40	<50	<60	<70	<90	<100	<125	<150	<200	<250	<300	
Appliance Branch Line Series																
FGP-LFD-70	70,000	1/2"Pipe	1/2"	1/2"	1/2"	1/2"	3/4"	3/4"	3/4"	3/4"	3/4"	3/4"	3/4"	3/4"	3/4"	1"
FGP-LFD-125	125,000	1/2"Pipe	3/4"	3/4"	3/4"	3/4"	3/4"	3/4"	3/4"	1"	1"	1"	1"	1"	1"	1-1/4"
Meter / Line Series																
FGP-LFD-275A or -275B	275,000	3/4"Pipe	1"	1"	1"	1"	1-1/4"	1-1/4"	1-1/4"	1-1/4"	1-1/4"	1-1/4"	1-1/4"	1-1/4"	1-1/2"	1-1/2"
FGP-LFD-375	375,000	1"Pipe	1"	1"	1-1/4"	1-1/4"	1-1/4"	1-1/4"	1-1/4"	1-1/4"	1-1/4"	1-1/2"	1-1/2"	1-1/2"	2"	2"
FGP-LFD-500	500,000	1"Pipe	1-1/4"	1-1/4"	1-1/4"	1-1/4"	1-1/4"	1-1/4"	1-1/2"	1-1/2"	1-1/2"	1-1/2"	2"	2"	2"	2"

**TABLE 3.3
PROPANE—AutoTrip “LFD” Series Excess Flow Valves**

AutoTrip Flow Rates in 1.52 S.G. / 2520 BTU/cu.ft. PROPANE						
Device	Btu/hr			SCFH		
	Typ. Load	Max Load	Nom. Closing	Typ. Load	Max Load	Nom. Closing
Appliance Branch Line Series						
FGP-LFD-70	110,779	110,779	158,256	44	44	63
FGP-LFD-125	189,907	197,820	276,948	75	79	110
Meter / Line Series						
FGP-LFD-275A	197,820	435,204	561,809	79	173	223
FGP-LFD-275B	276,948	435,204	561,809	110	173	223
FGP-LFD-375	284,861	593,460	751,716	113	236	298
FGP-LFD-500	284,861	791,280	1,084,054	113	314	430

**TABLE P-1AT AUTOTRIP (Propane Low Pressure System 11 in w.c.)-TRACPIPE
Determine TracPipe CSST size based upon the AutoTrip “LFD” Series EFV Chosen and Length of CSST Run
Standard Propane Low Pressure (11 in w.c.)—Piping Pressure Drop 0.5 in w.c.**

Distance Range – Length in Feet

AutoTrip P/N	Max. Capacity BTU	0-10 Feet	<15	<20	<25	<40	<50	<60	<90	<100	<150	<200	<250	<300
Appliance Branch Line Series														
FGP-LFD-70	110,779	1/2"	1/2"	3/4"	3/4"	3/4"	3/4"	3/4"	1"	1"	1"	1"	1"	1-1/4"
FGP-LFD-125	197,820	3/4"	3/4"	3/4"	3/4"	1"	1"	1"	1"	1-1/4"	1-1/4"	1-1/2"	1-1/2"	1-1/2"
Meter / Line Series														
FGP-LFD-275A or -275B	435,204	1"	1"	1-1/4"	1-1/4"	1-1/4"	1-1/2"	1-1/2"	1-1/2"	1-1/2"	1-1/2"	1-1/2"	2"	2"
FGP-LFD-375	593,460	1"	1-1/4"	1-1/4"	1-1/4"	1-1/2"	1-1/2"	1-1/2"	1-1/2"	1-1/2"	2"	2"	2"	2"
FGP-LFD-500	791,280	1-1/4"	1-1/2"	1-1/2"	1-1/2"	1-1/2"	1-1/2"	1-1/2"	2"	2"	2"	2"	2"	2"

NOTE: : If you are installing a brand of CSST other than TracPipe, size each run to supply the Max Capacity of the AutoTrip device instead of the capacity of appliances on that run.

**TABLE 3.4
AUTOTRIP - GasBreaker Equivalency Chart**

EFV Type Application	Maximum Load Capacity(Btu/hr)	Auto Trip P/N	Auto Trip Inlet and Outlet Thread Connection(s)	Equivalent GasBreaker P/N	GasBreaker Inlet and Outlet Thread Connection
Appliance Branch Line	70,000	FGP-LFD-70	3/4" M-NPT & 1/2" F-NPT	FGP-GB090-075	3/4" M-NPT
Appliance Branch Line	125,000	FGP-LFD-125	3/4" M-NPT & 1/2" F-NPT	FGP-GB150-075	3/4" M-NPT
Meter / Branch Line	275,000	FGP-LFD-275A	3/4" M-NPT & 1/2" F-NPT	FGP-GB300-075	3/4" M-NPT
Meter / Branch Line	275,000	FGP-LFD-275B	1" M-NPT & 3/4" F-NPT	FGP-GB300-100	1" M-NPT
Meter / Branch Line	375,000	FGP-LFD-375	1" M-NPT & 3/4" F-NPT	FGP-GB400-100	1" M-NPT
Meter / Branch Line	500,000	FGP-LFD-500	1-1/4" M-NPT & 1" F-NPT	FGP-GB600-100	1" M-NPT

NOTE: For additional information regarding the AutoTrip or GasBreaker excess flow valves, please contact OmegaFlex at 800-671-8622.

FIGURE 3.12
Pressure Drop across Auto Trip "LFD" Series EFV at given Flow Rates

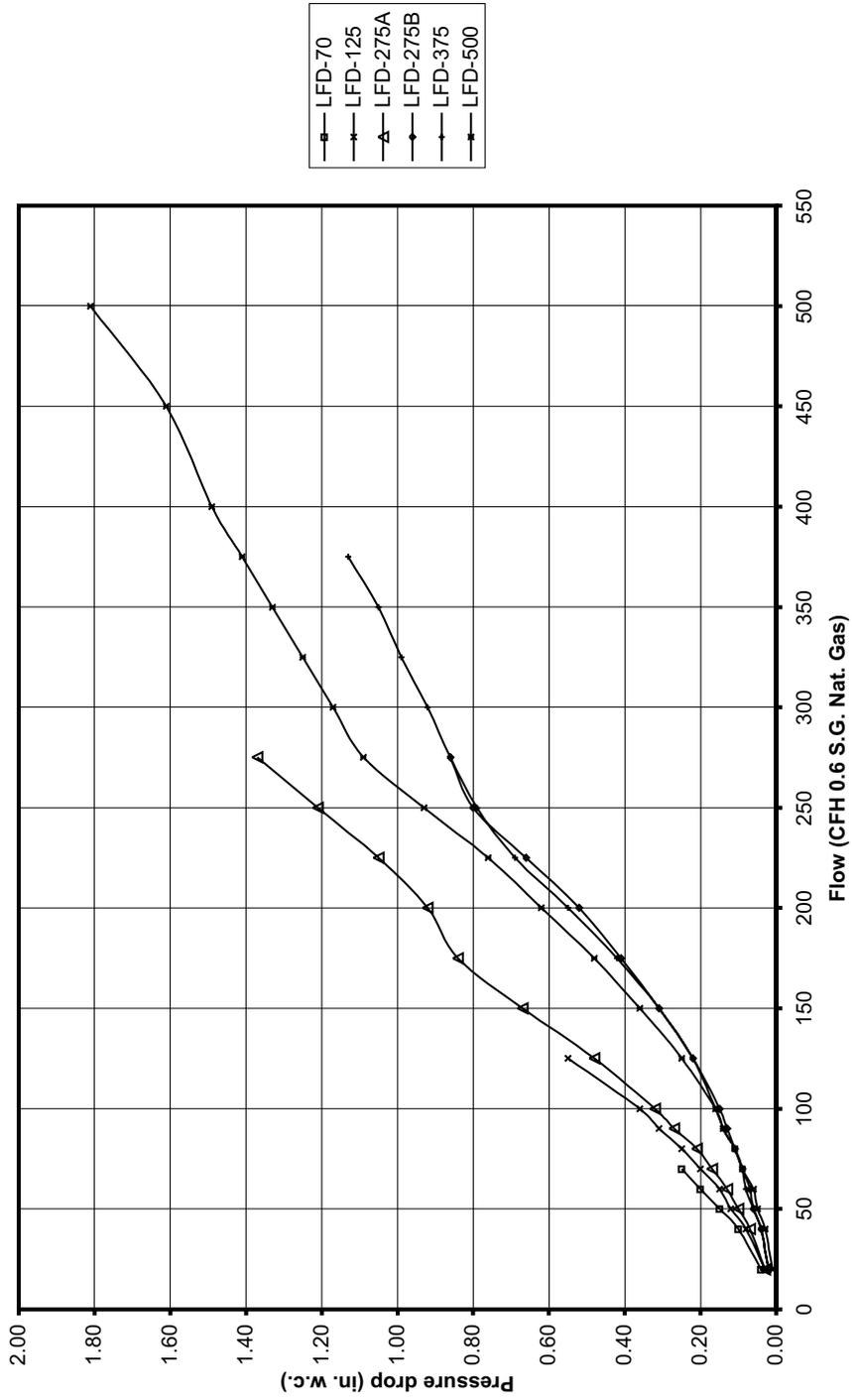

CHAPTER 4

INSTALLATION PRACTICES

SECTION 4.1 — GENERAL INSTALLATION PRACTICES

Precautions must be taken to ensure that any exposed flexible piping is not damaged or abused during building construction. All system hardware should be stored in a secure, dry location prior to installation.

1. The piping system is for use with fuel gas at operating pressures up to 25 PSI (USA and Canada restriction). **TracPipe** gas piping (3/8" up to 1-1/4" sizes) has been tested and is approved for pressures up to 125 PSI, and may ONLY be used at this pressure with the consent of the local gas utility and code authority. 1-1/2" & 2" size **TracPipe** gas piping has been tested and are approved for pressures up to 25 PSI. Pressure tests up to 125 PSI are permitted on sizes up to 1-1/4".
2. Only components provided by OMEGA FLEX or specified as part of the **TracPipe** piping system are to be used in the installation.

DO NOT USE **TRACPIPE** TUBING OR FITTINGS WITH TUBING OR FITTINGS OF ANY OTHER MANUFACTURER. INTERMIXING OF CSST TUBING OR FITTING COMPONENTS BETWEEN CSST MANUFACTURERS IS PROHIBITED. CONNECTIONS BETWEEN TWO DIFFERENT BRANDS OF CSST MAY

BE ACCOMPLISHED USING STANDARD MALLEABLE IRON FITTINGS.

3. Ends of the piping are to be temporarily capped, plugged or taped closed prior to installation and pulling through structure to prevent entrance of dirt, or other debris.
4. Contact with sharp objects or harmful substances is to be avoided. **Contact with any chemicals containing chlorides or ammonia must be followed by thorough rinse and wipe dry.** Typical chloride based chemicals include fluxes used for soldering copper tubes and acid based cleaners such as muriatic acid used for cleaning brickwork. **Use only non-corrosive leak detection fluids.** (Available: TracPipe Leak Check Solution P/N FGP-LCS)

5. BENDING **TRACPIPE**
Undue stress or strain on the tubing or fittings is to be avoided. Bending flexible gas piping is one feature which contributes to the speed of installation.

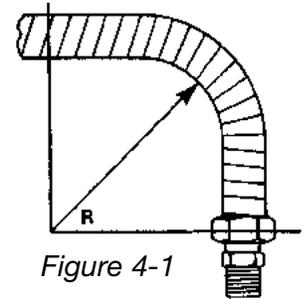

Figure 4-1

The recommended bend radius for general routing of tubing is listed in Table 4-1. Multiple tight bends can restrict the gas flow and increase pressure drop. The tightest bend allowed for each size of **TracPipe** is shown in the chart below.

RECOMMENDED MINIMUM BENDING RADIUS FOR FLEXIBLE GAS PIPING

Table 4-1

TUBING SIZE	ABSOLUTE MINIMUM BEND RADIUS R	RECOMMENDED MINIMUM BEND RADIUS R	
3/8 inch	9/16 inch	3 inches	
1/2 inch	3/4 inch	3 inches	
3/4 inch	1 inch	3 inches	
1 inch	3 inches	5 inches	
1-1/4 inch	3 inches	5 inches	
1-1/2 inch	3 inches	5 inches	
2 inch	4 inches	6 inches	

Typical locations requiring tight bends are termination mount installations in hollow stud walls.

6. SUPPORTING **TRACPIPE**

Piping shall be supported in a workman-like manner with pipe straps, bands, brackets or hangers suitable for the size and weight of the piping. **TracPipe** which passes over or through a structural member is considered to be supported by that member.

6A. VERTICAL RUNS

Spacing of supports is not to exceed 10 feet, requiring hangers only where the height of each floor is greater than 10 feet.

6B. HORIZONTAL RUNS

Spacing of supports Hangers, supports and anchors-Piping shall be supported at intervals not to exceed those shown in Table 4-2. It is acceptable to use standard pipe straps or tubing clips available in metal or plastic materials, OMEGAFLEX has found that the use of two-attachment point plastic clips or metal EMT pipe straps is advisable.

Some plastic clips, especially the “J-clips” designed to support plastic tubing are susceptible to breakage upon subsequent handling by other trades.

HORIZONTAL OR INCLINED RUNS

Table 4-2

PIPING SIZE	SPACING OF SUPPORTS
3/8 inch	4 FEET
1/2 inch	6 FEET
3/4 inch	8 FT. (USA) 6 FT. (CANADA)
1 inch	8 FT. (USA) 6 FT. (CANADA)
1-1/4 inch	8 FT. (USA) 6 FT. (CANADA)
1-1/2 inch	8 FT. (USA) 6 FT. (CANADA)
2 inch	8 FT. (USA) 6 FT. (CANADA)

SECTION 4.2

HOW TO ASSEMBLE *TracPipe* AUTO-FLARE FITTINGS

INSTRUCTIONS for making Fitting Connections to Flexible Gas Piping

1. CUT-TO-LENGTH: Determine proper length. Cut through plastic jacket and stainless tube using a tube cutter with a sharp wheel. Cut must be centered between two corrugations. Use full circular strokes in one direction and tighten roller pressure slightly (a quarter turn) after each revolution. DO NOT OVERTIGHTEN ROLLER, which may flatten tube.

NOTE: Due to the large diameter and depth of corrugation on sizes over 1", tubing must be cut with a standard tubing cutter RIDGID™ 152 or equal using a *TracPipe* cutting wheel no. FGP-E-5272 (P/N E-5272 or equal). **CAUTION:** Use of a small cutting wheel may flatten the first corrugation and make cutting and/or sealing of fittings difficult.

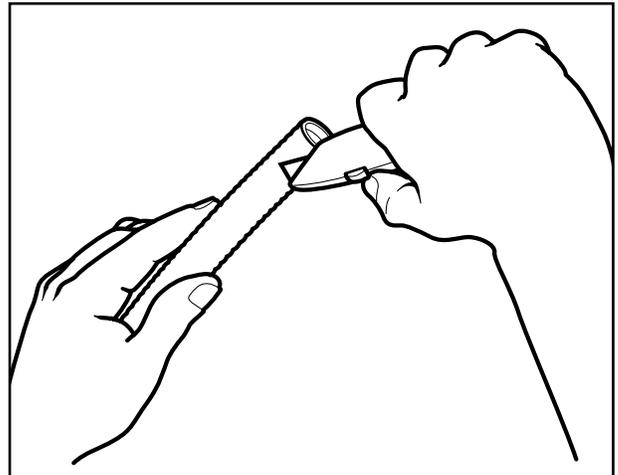
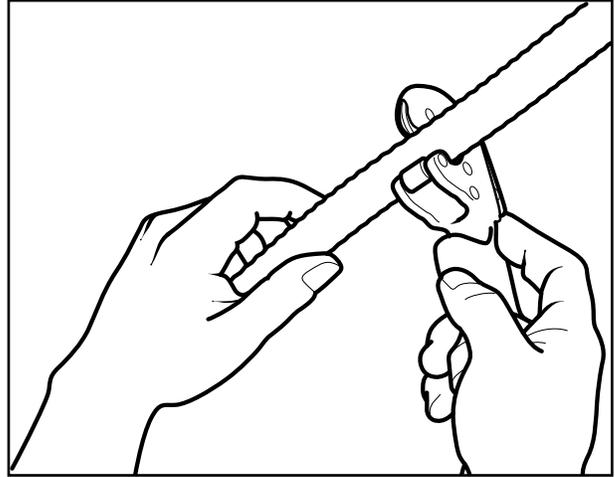

2. STRIP JACKET: Using a utility knife, strip back the jacket approximately one inch to allow assembly of fittings. **Caution: For your personal safety--Knife blade and cut tube ends are both sharp. Use care when cutting the jacket and handling the tube.**

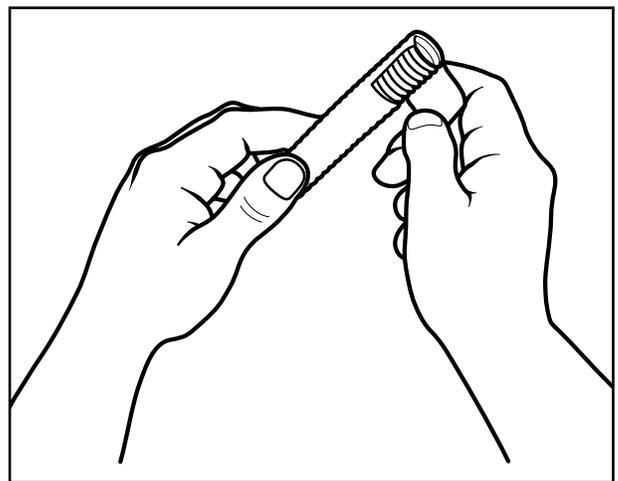

INSTRUCTIONS for making Fitting Connections to Flexible Gas Piping (Continued)

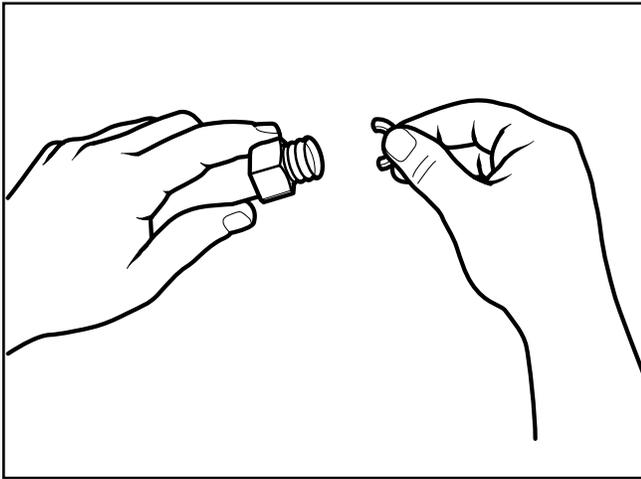

3. **INSTALL FITTING NUT:** Slide nut over cut end: place two split-rings into the first corrugation next to the tube cut. Slide nut forward to trap the rings.

4. **WRENCH FITTING:** Place the adapter into the nut and engage threads. Note that the AutoFlare® fitting is designed to form a leak tight seat on the stainless tubing as you tighten the fitting. (The piloting feature of the adapter will not always enter the bore of the tubing before the tightening operation, but will center the fitting when tightened). Using appropriate wrenches, tighten the fitting until adapter bottoms and the resistance to wrenching increases greatly. The flare has now been created on the tubing end.

CAUTION- DO NOT USE ANY THREAD SEALANTS FOR THIS CONNECTION. SEALANTS ARE TO BE USED ON THE PIPE THREAD ONLY.

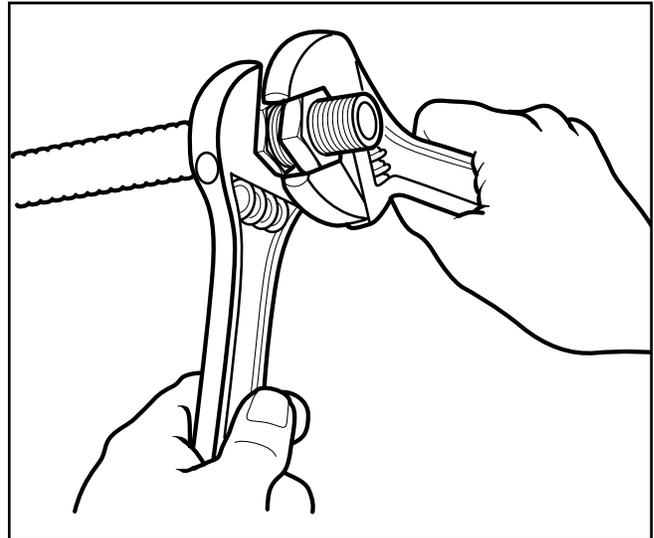

5. **FINAL TORQUE:** Tighten nut and adapter to the torque values shown in Table 4-3. For field installations use the following method: Tighten nut and adapter as though you were making up a flared tubing joint. Note relation between hex flats at this point and continue to tighten for two additional hex flats (one-third turn) to obtain required torque and final leak-tight seal.

Table 4-3

Flexible Pipe Size	Fitting	Torque Value
3/8" FGP-SS4-375	FGP-FST-375	40 ft.-lb.
1/2" FGP-SS4-500	FGP-FST-500	42 ft.-lb.
3/4" FGP-SS4-750	FGP-FST-750	45 ft.-lb.
1" FGP-SS4-1000	FGP-FST-1000	75 ft.-lb.
1-1/4" FGP-SS4-1250	FGP-FST-1250	150-200 ft.-lb.
1-1/2" FGP-SS4-1500	FGP-FST-1500	200-250 ft.-lb.
2" FGP-SS4-2000	FGP-FST-2000	250-300 ft.-lb.



AutoFlare® (Patented) – The Fitting is the Flaring Tool

SECTION 4.2A — TROUBLE SHOOTING FITTING CONNECTIONS

1. The tubing cut is the critical step in the fitup procedure. Always cut in a straight section of piping, rather than an area you have bent. Use light roller pressure applied on every revolution to cut tube evenly around its surface. Remember that this tube has a thinner wall than the copper tube you are accustomed to cutting. A sharp blade is very important, and it will be helpful to reserve one cutter for stainless steel only.
2. If the fitting connection cannot be made to seal upon applying torque per the instructions in Section 4.2, continue to tighten an additional quarter to a half turn. If leakage continues, do not continue to apply torque. Disassemble the fitting and inspect the sealing surfaces. The most likely cause of leakage is foreign material on the sealing surfaces. Wipe both fitting and tubing flare with a clean cloth. Inspect the formed flare on the tubing end, which should appear round when compared with the split ring washers and the nut in place. If any deformation is noted, the tubing can be recut and the fitting re-attached. The patented Autoflare fitting has an insert which is self piloting and **does not require special tooling to make a leak proof fitting.**
3. REASSEMBLY - When reattaching the AutoFlare fitting, it is only necessary to re-insert the split rings into the space between the first two corrugations and to pull the nut back over the rings into position. The adapter can then be conveniently re-threaded into the nut and torqued as before. If the nut cannot be pulled into place, examine the split-rings, which may have been “coined” by the first torque operation. If this is the case, simply reverse the split-rings positioning to align with the nut and continue the assembly process. If the fitting is reattached more than three times, or if the nut cannot be pulled over the rings in any position, then the split-rings must be replaced. Packets of spare split-rings are available (P/N FGP-RING-SIZE) and the remaining fitting parts can be re-used.

SECTION 4.3 — ROUTING

Depending on local building codes and construction practice, Flexible gas piping can be routed:

1. Beneath floor joists, through floor and ceiling joists, along side of floor and ceiling joists. This is the typical location for residences and commercial buildings with basements and for multi-floor systems. Multiple tubing runs may be bundled.
2. Inside hollow interior wall cavities. This is the preferred location for vertical sections of piping, rather than horizontal sections.
3. Through approved conduit under ground or under building slabs. When piping runs are located below grade or under a concrete slab, the **TracPipe** shall be routed within a non-metallic water-tight conduit. No tubing joints are permitted within the conduit. Gas piping runs beneath building slabs must be both sleeved and vented to the atmosphere. See Underground Installations Section 4.9 for underground use of **TracPipe PS** and **TracPipePS-II**. **TracPipe PS** and **TracPipePS-II** meet code requirements for underground and under building slab installation.
4. Clearance holes for routing the piping through studs, joists, plates etc. shall have a diameter at least 1/2 inch larger than the outside diameter of the piping. When a structural member must be drilled, conformance to building codes must be followed. No structural member shall be seriously weakened or impaired by cutting, notching or otherwise altering the member. Minimum drill hole sizes are listed in Table 4-4.

Table 4-4

TUBING SIZE	DRILL HOLE SIZE
3/8 inch	1-1/8 inch
1/2 inch	1-3/8 inch
3/4 inch	1-1/2 inch
1 inch	1-3/4 inch
1-1/4 inch	2-1/4 inch
1-1/2 inch	2-1/2 inch
2 inch	3 inch

5. METAL STUDS

For installations involving horizontal runs through galvanized steel studs, the use of plastic grommets supplied by the stud manufacturer is recommended. The use of these grommets will reduce the likelihood of damage to the tubing non-metallic jacket.

SECTION 4.3A — CONCEALED LOCATIONS FOR FITTINGS — GENERAL PROVISIONS

The **AutoFlare**® mechanical attachment fittings have been tested and are listed per the requirements of ANSI LC1 and CSA 6.26 Standard (USA and CANADA) This specification provides test requirements which certify fittings for concealed installations and connections to appliances where concealing the fittings is the only practical alternative.

These guidelines address some of the known situations which may require the use of a concealed fitting. While accessibility of fittings may be desirable there are often situations where concealing the fittings is the only practical option. This guide cannot address all applications of concealed fittings but provides instead typical instructions to demonstrate the principles which apply to fittings listed for installation in concealed locations (Ref National Fuel Gas Code NFPA 54 Chapter 6).

EXCLUSIONS:

1. Manifold Stations (for 2 PSI systems) which include the multiport manifold, shut off valve, and pressure regulator shall not be installed in concealed locations regardless of the qualifications of tubing fittings.

NEW INSTALLATIONS:

1. CSST may be connected to steel piping systems through threaded pipe connections. This can be a stub-out to an appliance connection or outdoors to a meter, etc.
2. Flexible piping connections to fireplace “key valves” can be located in a concealed location, when accessibility is not readily

provided. See Illustrations 1 & 2 for typical key valve mountings.

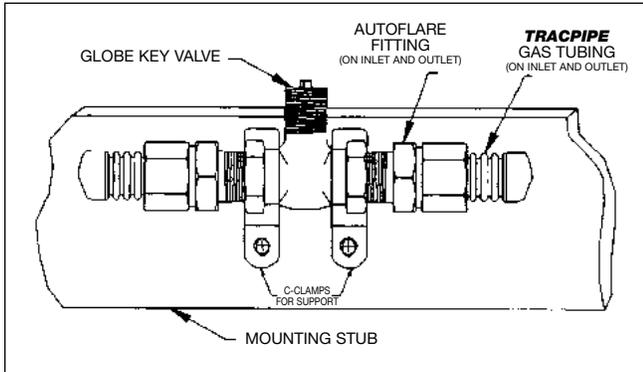

Illustration 1

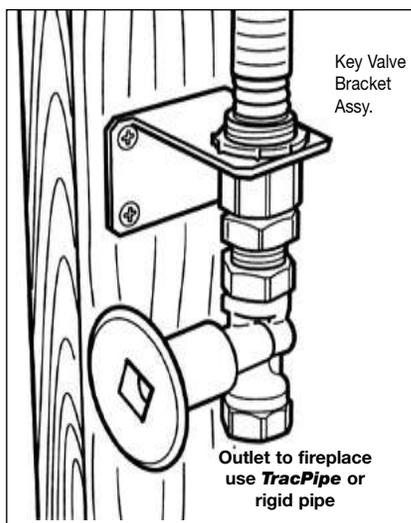

Illustration 2

- Multiple gas outlets – when multiple outlets are supplied from a single run of piping, each downstream outlet branch can be connected to the main run using a tee fitting which can be located in a concealed location.

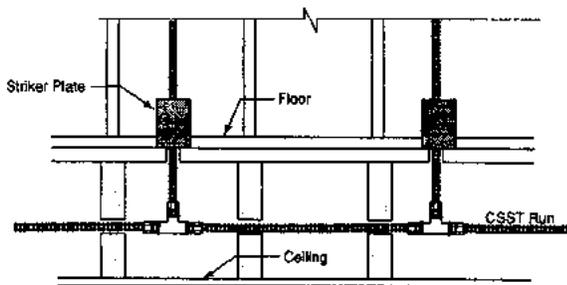

Figure 4-2 Multiple outlets along main tubing run

MODIFICATIONS TO INSTALLED SYSTEMS:

- New ceilings in unfinished rooms/basements-

Flexible piping fittings originally installed in accessible ceiling locations can be concealed at a later date in the event that a ceiling is installed. Precautions shall be taken to ensure that the newly concealed piping and fittings are adequately protected from accidental puncture in accordance with the instructions in this guideline.

- Extensions to existing tubing runs-A tubing run can be modified to permit an extension to another appliance location provided there is sufficient capacity to supply both appliances at the same time. If an accessible location for the modification is not available, the existing tubing run can be modified with a tee fitting, resulting in a concealed fitting.
- Repairs to existing tubing runs-Damaged tubing runs shall be repaired in accordance with instructions in this guide (Section 5.2). The repair can result in a line splice which may ultimately be located in a concealed location.

SECTION 4.3B — OUTDOOR INSTALLATION ISSUES

The following section provides instructions for the use of **TracPipe** in systems in which portions of the piping are exposed to the outdoors as required to make connections to gas meters or appliances which are attached to, mounted on, or located in close proximity to the building structure. ANSI/IAS LCI-CSA 6-26-1997 contains test requirements determining suitability for exposure of CSST piping systems to outdoor environments. **TracPipe** is certified to this standard and is fully qualified for outdoor installations. The **TracPipe** yellow jacket contains UV inhibitors to retard jacket degradation when exposed to long periods of sunlight.

- When installed outdoors, the plastic jacketing shall remain intact as much as practical for the given installation. Any portions of exposed stainless steel shall be wrapped with self bonding silicone tape sealing the fitting connection to prevent later corrosive attack by acid wash or chloride based compounds. (See Figures 4-3A & 4-3B)

- When **TracPipe** is installed in a swimming pool mechanical room or exposed to a corrosive environment which may be harmful to the tubing, all exposed portions of the stainless steel tubing shall be wrapped with self-bonding tape. (See Figures 4-3A & 4-3B)
- When installed along the side of a structure (between the ground and a height of 6 feet) in an exposed condition, the **TracPipe** shall be installed in a location which will not subject the piping to mechanical damage or be protected inside a conduit.

NOTE: For support and protection, OmegaFlex recommends that outside runs along the side of a building be clipped securely to the wall or other structural component.

- TracPipe** shall not be buried directly in the ground or penetrate concrete unless it is sleeved inside of a non-metallic (PVC or **TracPipe PS** or **PS-II** Polyethylene) water tight conduit. The conduit shall be sealed at any exposed end to prevent water from entering. See instructions for underground installations Section 4.9.
- When installed underneath mobile homes or in crawl spaces, **TracPipe** shall be installed in accordance with these standard outdoor instructions.

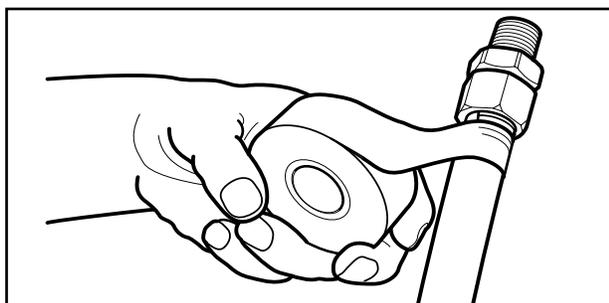

Figure 4-3A Wrapping with self bonding silicone tape - begin on jacket.

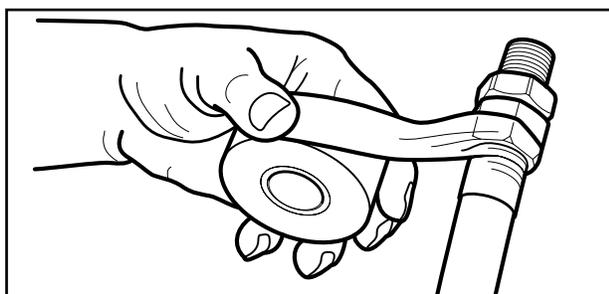

Figure 4-3B Wrapping with self bonding silicone tape - end on nut.

SECTION 4.4 — PROTECTION

The flexible gas piping must be adequately protected from puncture, shear, crush or other physical damage threats. The tubing shall be protected at points of support and when passing through structural members such as studs, joists and plates in accordance with this section. PROTECTION IS REQUIRED WHENEVER THE TUBING IS CONCEALED, RESTRAINED, AND WITHIN 3 INCHES OF A POTENTIAL THREAT. If the tubing requires protection, the following measures should be taken.

SECTION 4.4A — STRIKER PLATE REQUIREMENTS

- Install shielding devices i.e. striker plates to protect the tubing from penetration by drill bits, nails, screws, etc. in those areas where the tubing will be concealed and will not be free to move to avoid such puncture threats.

NOTE: Only CSA approved hardened striker plates listed for CSST systems may be used.

- At support points and points of penetration less than 2 inches away from any edge of a stud, joist, plate, etc. shielding is required at the area of support and within 5 inches of each side (if appropriate). Use a half striker or a full striker plate in these locations. (Figure 4-4)

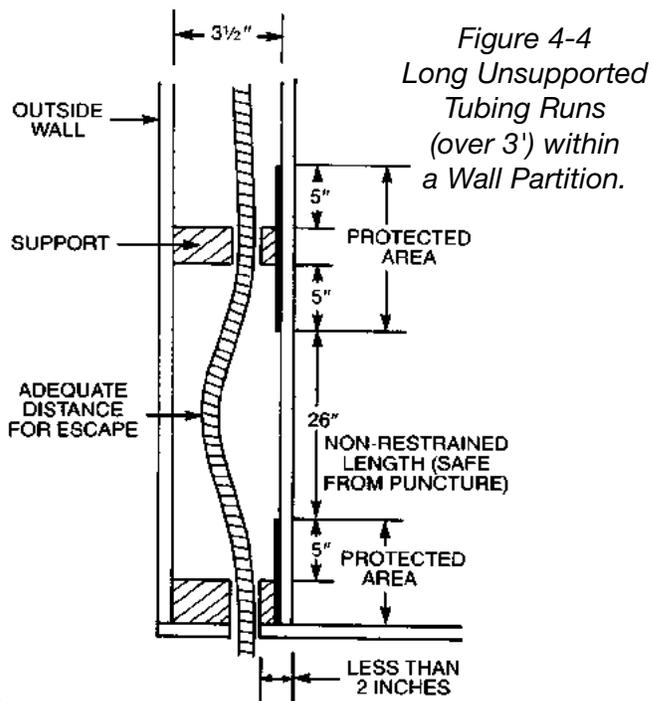

Figure 4-4
Long Unsupported
Tubing Runs
(over 3') within
a Wall Partition.

b. At support points and points of penetration 2 to 3 inches from any edge of stud, joist, plate, etc. shielding is required throughout area of support. Use a quarter striker plate in these locations. (Figure 4-5)

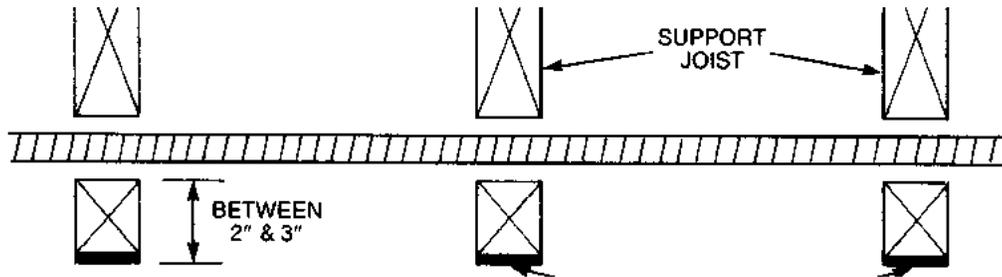

Figure 4-5

Shielding Requirements at Support Area when Points of Penetration are 2-3 inches from any Edge of a Stud, Joist, Plate, etc.

c. Hardened steel striker plates provide the required protection through building structures as described above. Type RW Floppy steel conduit shall be installed as additional protection at termination points. (Figure 4-7)

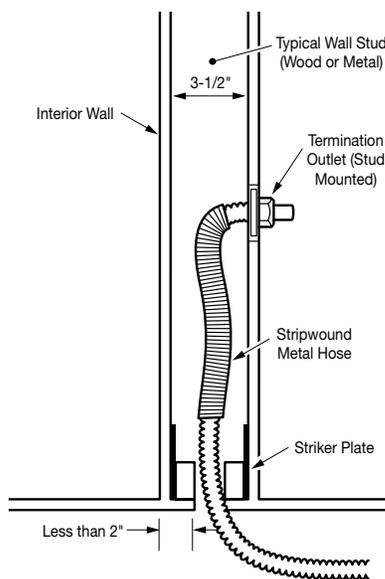

Figure 4-7

d. When tubing is routed horizontally between studs, install quarter striker plates at each stud and floppy galvanized steel conduit (spiral metal hose) along the entire length.

e. Schedule 40 steel pipe has been tested by CSA International and found acceptable for puncture protection. Steel pipe can be used where standard striker plates cannot reasonably be installed. Examples of this type of use

include: (but are not limited to) outside walls of buildings with sheathing in place, between floors with enclosed joist areas, and retrofits in existing buildings with walls in place. Steel pipe having an inner diameter at least one-

half inch larger than the **TracPipe** O.D. is approved by CSA International for this use as an alternate to striker plates. Protection must extend 5 inches beyond the penetration of the structural member(s). A 12 inch pipe length is appropriate for penetration of a single stud. Omegaflex recommends the use of standard striker plates where the building construction permits their installation. See Chart for pipe sizes.

TracPipe Size	Steel Pipe Size
3/8 inch	1-1/4 inch
1/2 inch	1-1/4 inch
3/4 inch	1-1/2 inch
1 inch	2 inch
1-1/4 inch	2-1/2 inch
1-1/2 inch	2-1/2 inch
2 inch	3-1/2 inch

2. The best protection is to install the tubing in those out of the way areas where testing has shown no protection is necessary, for example:

a. Where the tubing is supported more than 3 inches from any outside edge of a stud, joist, plate, etc. or wall surface. (Figure 4-6)

b. Where any non-restrained tubing can be displaced from the direction of potential penetration at least 3 inches.

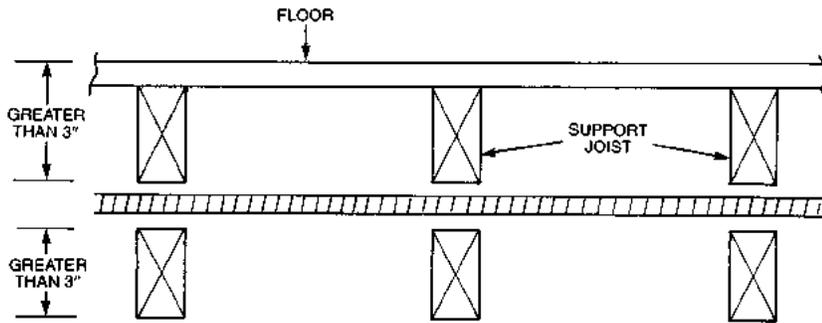

Figure 4-6

No Shielding Requirement at Support Area when Points of Penetration are greater than 3 inches from any Edge of a Stud, Joist, Plate, etc.

- c. When tubing is supported under the joists in basements or crawl spaces and is not concealed by wallboard or ceilings.
3. **TracPipe** with its specially formulated yellow polyethylene jacket has been tested to the flame spread and smoke density requirements of ASTM E84 and meets ANSI LC-1 limits imposed for this criteria.
4. For through-penetration fire stop instructions refer to the UL classification requirements shown in appendix A. When passing through a fire stop (2hr. wall) the YELLOW jacket does not have to be removed. Seal between building and **TracPipe** with an approved 3M type CP-25 or equivalent caulk.
5. **TracPipe** has thru-penetration UL Classifications for 1,2 and 4 hour requirements depending on materials and type of construction. See Appendix A.
6. **CounterStrike**[®] date coded 0731 and higher meets building code requirements (ASTM E84) with respect to flame spread and smoke density. This permits installation in drop ceilings used as return air plenums.
7. **CounterStrike**[®] date coded 0731 and higher has thru-penetration UL Classifications for 1,2 and 4 hour requirements depending on materials and type of construction. See Appendix A.

NOTE: For *TracPipe PS-II* tubing version with Black outer jacket, the installer shall meet local building codes with respect to flame spread and smoke density regulations for non-metallic materials. Omegaflex recommends either removing the black jacket or transitioning to the standard yellow jacketed product when passing through areas such as drop ceiling return plenums.

SECTION 4.5 — METER CONNECTIONS

1. Meters which depend on the service and house piping for support shall not be directly connected to the flexible piping. Instead, use a meter termination fitting or termination mount fitting with steel pipe for the outdoor portion of the connection. For mounting of meters, all fastener locations should be used when installing the flange or mounting plate. (Figure 4-8)
2. Meters which are independently supported with a bracket can be directly connected outdoors with **TracPipe**. If practical, direct connections shall include a 3 to 6 inch additional length of tubing to accommodate differential settling and meter movement. No mechanical protection of the tubing is required for outdoor connections. **PRIOR TO INSTALLING TracPipe DIRECTLY TO A METER, ENSURE THAT THE LOCAL UTILITY ALLOWS THIS PRACTICE** as some utilities have regulations specifying meter attachments. Any exposed sections of stainless steel piping must be wrapped with a silicone self-bonding tape. This is especially important with masonry construction. (Figure 4-9) A PVC Sleeve is recommended for **TracPipe** penetration of both masonry and wood frame construction.

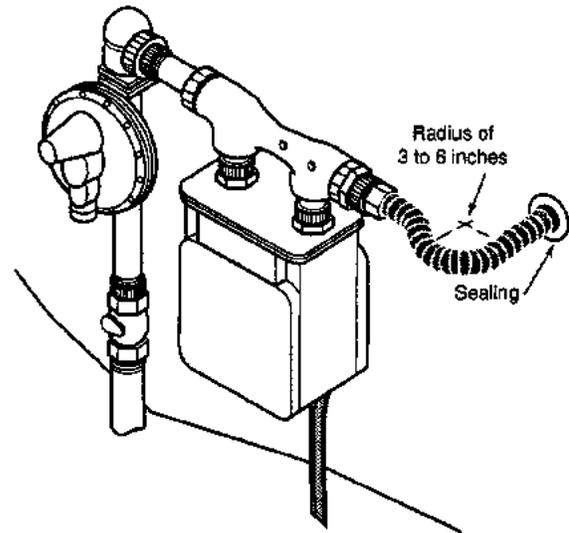

Figure 4-9

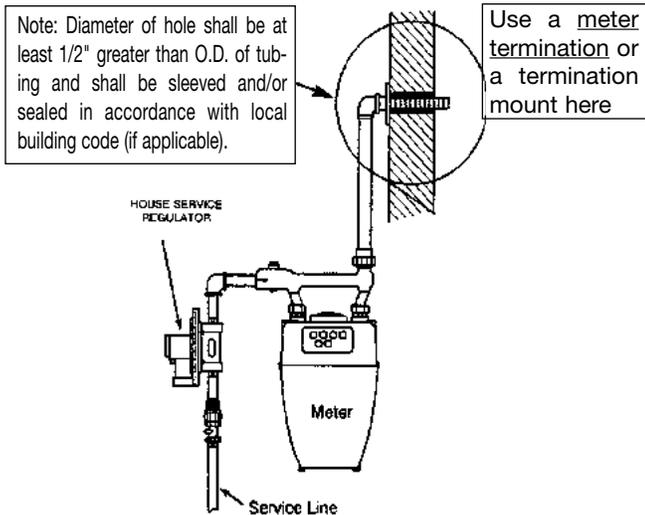
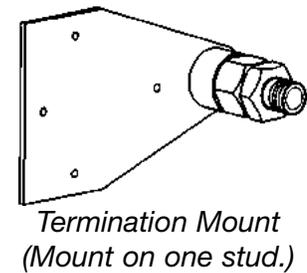
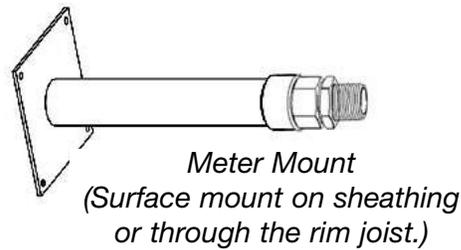

Figure 4-8

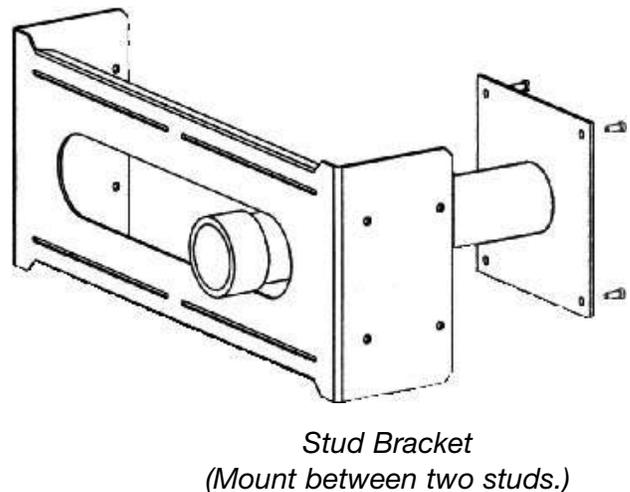

Figure 4-10
Meter Mounting Accessories

SECTION 4.6 — APPLIANCE CONNECTIONS

A listed termination outlet (termination mount or flange fitting) shall be installed and secured to the structure at all floor & hollow wall piping outlets used for moveable appliances and quick disconnect devices. The termination outlets are designed to simplify the installation of gas connections for moveable appliances and minimize the need for concealed fittings. The flange fitting or plate shall be securely fastened in place during rough-in. It may be attached to a brace spanning between studs for a wall location, or directly to the floor. (Figure 4-11) The flange may also be mounted with a flange L- bracket, which is nailed or screwed to the stud.

When a moveable appliance is in a location where a termination outlet cannot be readily installed through the structure, the **TracPipe** can be transitioned to black pipe at a suitable location and

the black iron pipe fastened to the block walls or concrete. Another option is to use termination mounting bracket fastened to the block wall and make the drop with **TracPipe**. Final connection is with a flexible appliance connector.

1. MOVABLE APPLIANCE CONNECTIONS (SUCH AS RANGES AND DRYERS) SHALL BE MADE USING APPROVED FLEXIBLE APPLIANCE CONNECTORS.

(Figure 4-12)

See also recessed wall box Section 4.6-3.

2. FIXED APPLIANCE CONNECTIONS MAY BE DIRECTLY CONNECTED TO THE FLEXIBLE GAS PIPING SYSTEMS (in most jurisdictions). When the fixed appliance is located in a secure, dedicated space, such as a basement, attic, garage or utility closet, the flexible piping may be directly connected to the appliance shut-off valve without installation of a flange fitting or flexible appliance connector.

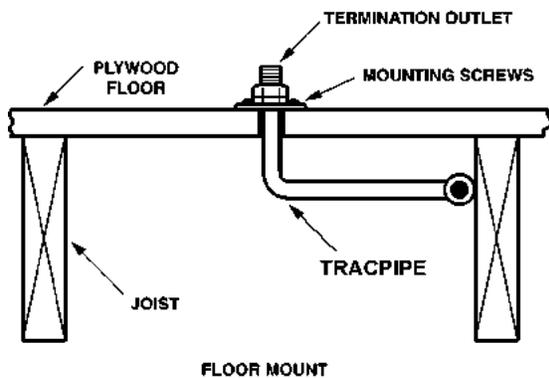

Figure 4-11
Support Device Flange Termination Outlet

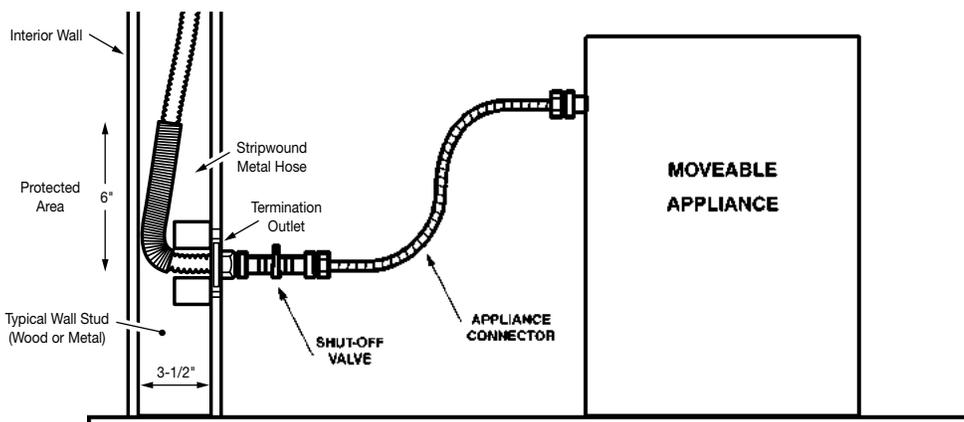
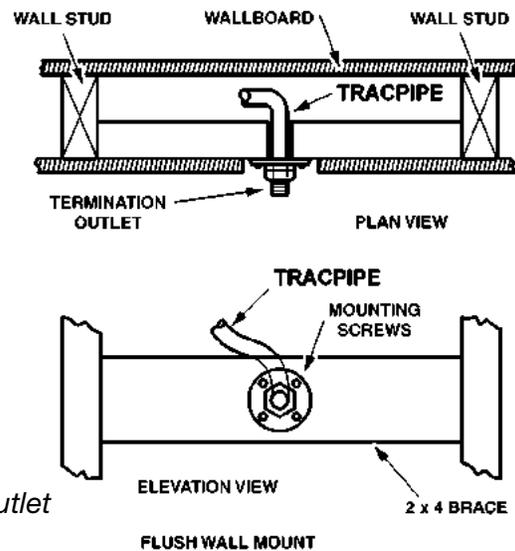

Figure 4-12
Stainless Steel Gas Connector Connection to a Movable Gas Appliance

3. RECESSED WALL BOX

TracPipe Part Number FGP-WBT-SIZE
(Not fire rated)

TracPipe Part Number FGP-WBTM-SIZE
(Fire rated to UL 1479)

Product Description: TracPipe Recessed Wall Box makes possible appliance stub outs with zero clearance for a finished appearance in laundry rooms, kitchens and mechanical rooms. This accessory provides a rigid attachment point for appliance connectors serving movable appliances.

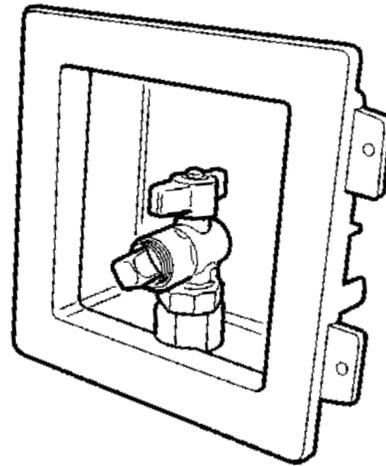

Caution: FGP-WBT is not a fire rated box. Before installing on a fire wall, consult your local code authority for acceptable installation practices. FGP-WBTM is fire rated to UL 1479. This box has been designed for use with **TracPipe** Flexible Gas Piping as an appliance termination and is not suitable for connection to any other CSST brand or black iron pipe. Installers must be trained on **TracPipe** before installing this product.

3A. Wall Box Installation Instructions

1. Install **TracPipe** gas pipe and cut to desired length using a tubing cutter with sharp wheel. Strip yellow jacket back approximately 2". Inspect pipe for a clean cut without tears.

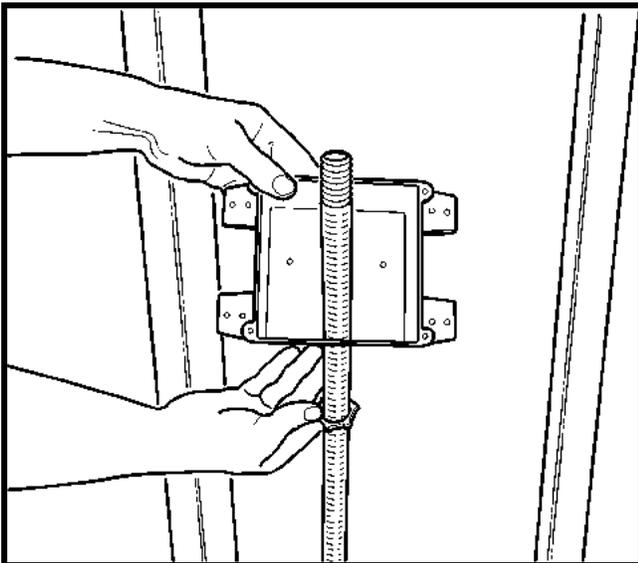

2. Remove box cover and slip locknut and box over end of pipe.

BOX

COVER

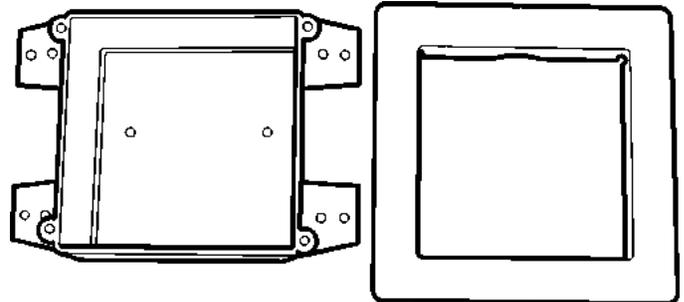

P/N FGP-WBT shown

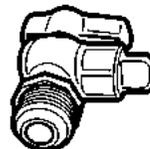

VALVE

NUT

**SPLIT
RINGS**

LOCKNUT

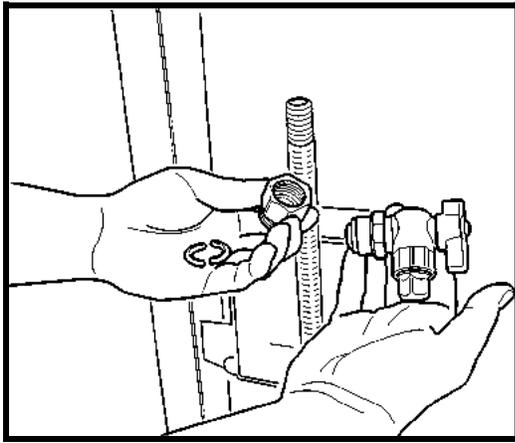

3. Disassemble valve and split rings from nut.

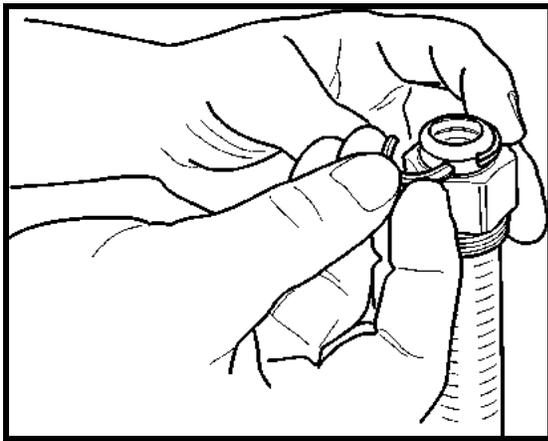

4. Slip nut over end of pipe and insert split rings into valley of the first corrugation.

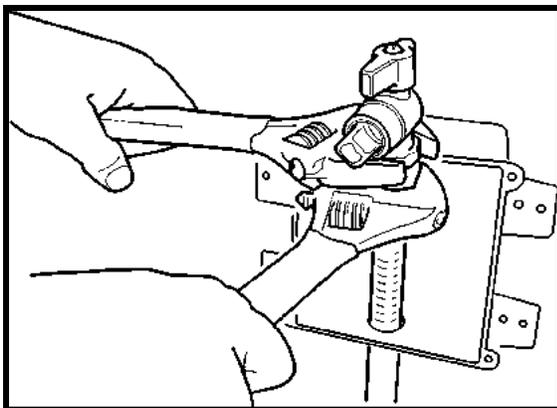

5. Thread 90 degree ball valve onto nut and tighten so valve outlet faces forward. It is recommended that crescent wrenches be used to avoid damaging valve or nut. **Do not use thread sealants on this connection.**

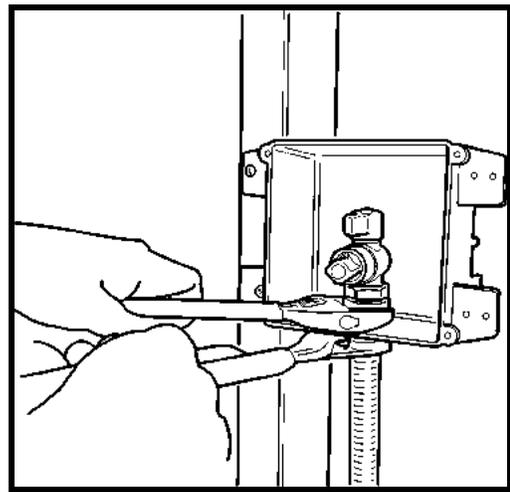

6. Slide box up and over the threads on the bottom of the nut and mount box to stud.

7. Secure valve assembly to box with lock-nut.

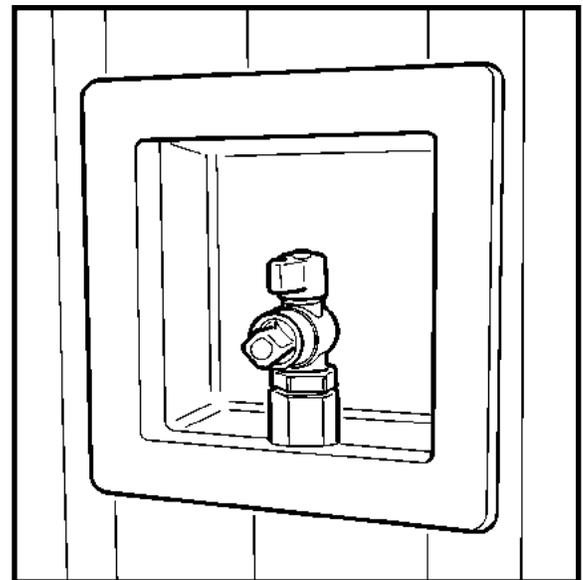

8. Install box cover after completion of dry-wall.

SECTION 4.6A — PAD MOUNTED EQUIPMENT, ROOF TOP EQUIPMENT

1. Gas appliances mounted on concrete pads or blocks, such as gas air conditioners heat pumps, pool heaters and NGV refueling stations, shall be connected to the **TracPipe** system at a termination fitting using either rigid pipe or an approved outdoor appliance connector. Direct connection of **TracPipe** to pad mounted equipment is permitted when the CSST is securely supported and located where it will be protected from physical damage. Follow local and state codes.

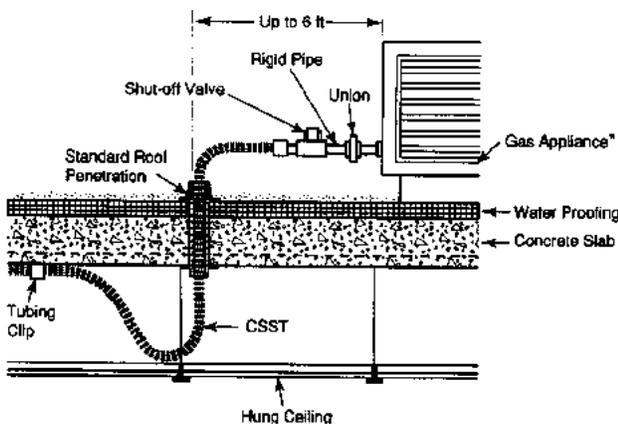

Figure 4-13 Short (1-6 foot) outdoor connection to roof mounted equipment

2. No special mechanical protection of the piping is required for connection to roof top equipment. Whenever possible, roof penetrations shall be located within 6 feet of the equipment to be connected as shown in figure 4-13. Long runs of tubing shall be supported with non-metallic blocks at the support interval listed in

Table 4-2, and raised above the roof a distance determined by local code/practice.

3. **TracPipe** may be supported with strut/channel running from block to block beneath the flexible gas pipe. Galvanized shallow channel (13/16") with splice plates at joints and bends provides a secure, damage resistant "track". With metallic strut support, blocks can be reduced to every 8 feet. The **TracPipe** should be firmly attached to each block with metallic clamps designed for the strut or appropriate fastening mechanism. (See Figure 4-15) Black cable ties (UV resistant) at intermediate points facilitate rolling out the **TracPipe**. The blocks are to be attached to the roof surface in accordance with the roofing manufacturer's instructions.

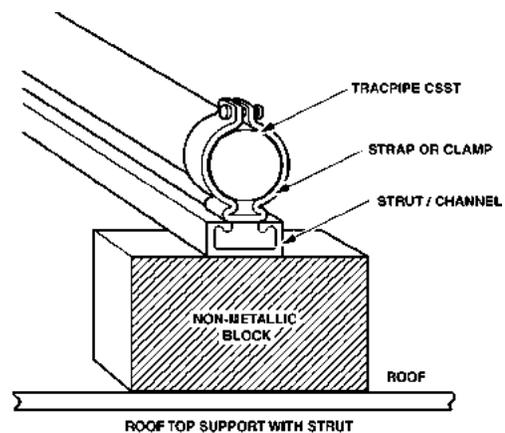

Figure 4-15

4. Piping run vertically up the side of the building shall be protected in accordance with the General Provisions section of the outdoor use guidelines (section 4.3B).

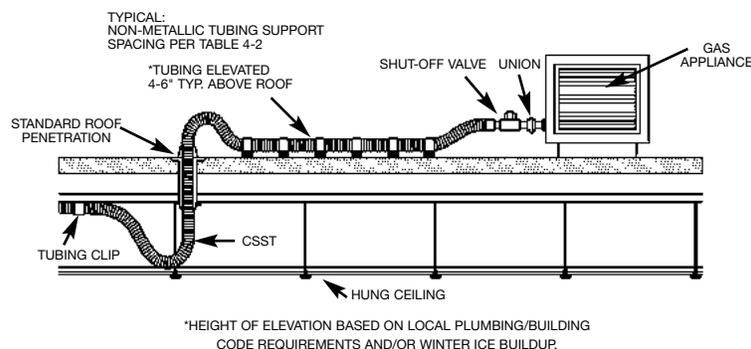

Figure 4-14

SECTION 4.6B — OUTDOOR APPLIANCES — BARBEQUE GRILL AND GAS LIGHT CONNECTIONS

1. Movable Grills shall be connected using an approved outdoor appliance connector which shall be attached to the flexible piping system at either a termination mount fitting, a transition to a steel nipple, or a quick-connect device such as the M. B. Sturgis Model 3/375 shown in figure 4-16. The quick-connect outlet shall be installed in accordance with manufacturer's instructions.
2. Permanently mounted grills located on decks shall be connected with the **TracPipe** system as shown in figure 4-17 and in accordance with this guide. The outdoor portion of the piping shall be supported against the side of any of the inside deck joists. If the elevation of the deck is below the top of the foundation, any exposed piping shall be protected using water-tight non-metallic conduit.

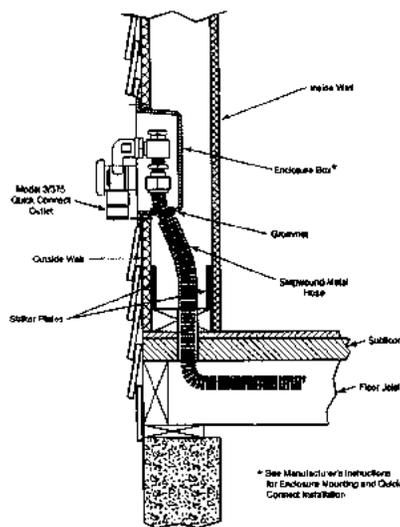

Figure 4-16

3. Permanently mounted lights located on decks shall be connected to the piping system the same as permanently mounted grills shown in figure 4-17 and in accordance with the manufacturer's instructions.

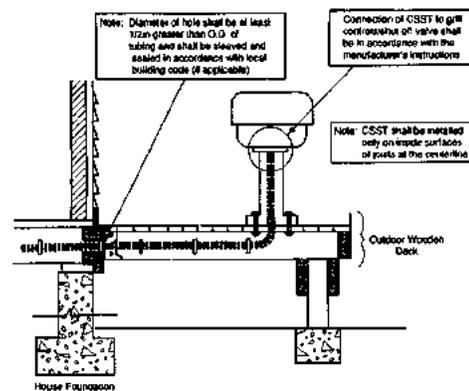

Figure 4-17

4. Yard mounted lights shall be connected to the **TracPipe** system as shown in figure 4-18. All piping installed below grade shall be protected by non-metallic, water-tight conduit or **TracPipe PS** or **TracPipe PS-II** for underground use. Exposed ends of the conduit shall be sealed against water entry.

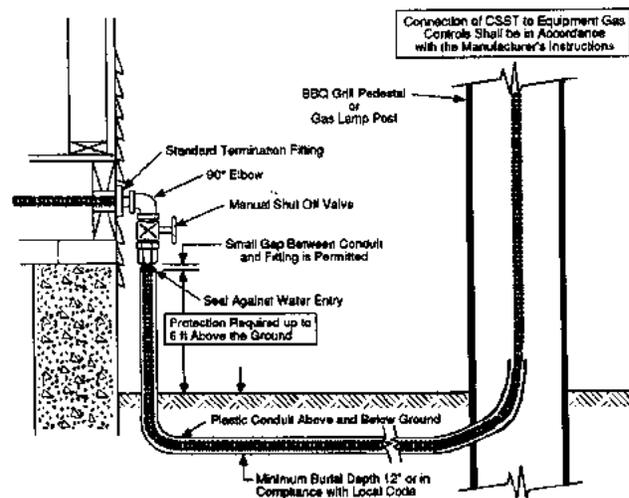

Figure 4-18

Section 4.6C — FIREPLACE INSTALLATIONS

1. **TracPipe** may be used to deliver gas directly to the valve for a gas fireplace. This is approved for decorative and heat generating fireplaces and for gas logs used in masonry and pre-fabricated fireplaces. DO NOT use **TracPipe** to connect gas log lighters or gas wands for use in all-fuel (woodburning) fireplaces.
2. Most gas fireplaces and gas logs (Refer to ANSI Z24.60) fall into the definition of fixed appliances which can be directly connected to **TracPipe** without the use of a flange mount fitting. The attachment is generally to the shut-off valve which may be located in the control area beneath the burner unit or at the side of the log set. **TracPipe** can be run into the lower control area for attachment without removal of the polyethylene jacket. In vented fireplaces, attachment to gas logs is best accomplished by removal of the jacket inside the fire box. This precludes direct flame contact with the polyethylene jacket. Stainless Steel melting temperatures (2000° F) are consistent with black iron.
3. For gas log lighter installations in all-fuel fireplaces, the **TracPipe** run MUST be terminated at the key valve or another location outside the fireplace. The final attachment should be made using black iron pipe.
4. When it is necessary to install **TracPipe** through sheet metal enclosures, such as those commonly used in decorative gas fireplaces, the manufacturer's recommendation is to leave the protective yellow polyethylene jacket in place through the sheet metal penetration. The **TracPipe** should be clipped to the building structure at a suitable location outside the fireplace to limit the amount of motion after installation. If additional protection is required, such as an installation with a source of vibration (fan, etc.) which may cause abrasion, then a short piece of floppy conduit or PVC pipe may be used between the jacket and the enclosure.
5. In masonry fireplace installations of decorative gas appliances (log sets) it is recommended to leave the polyethylene jacket in place throughout the masonry penetration providing a non-metallic sleeve for the flexible stainless steel. Caulking can then take place between the jacket and the penetration at interior and/or exterior locations. Remove the jacket inside the firebox. If additional protection is required, the **TracPipe** may be sleeved using PVC pipe in addition to the included jacket.
6. The FGP-FPT may be used in all applications where it is desirable not to penetrate the enclosure with tubing. (See figure 4-24)

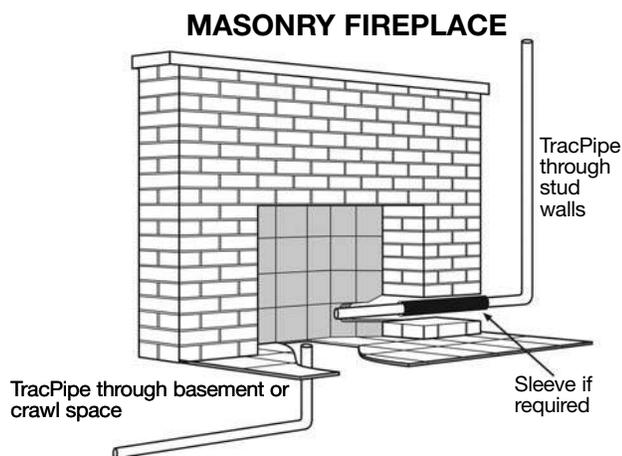

Figure 4-23

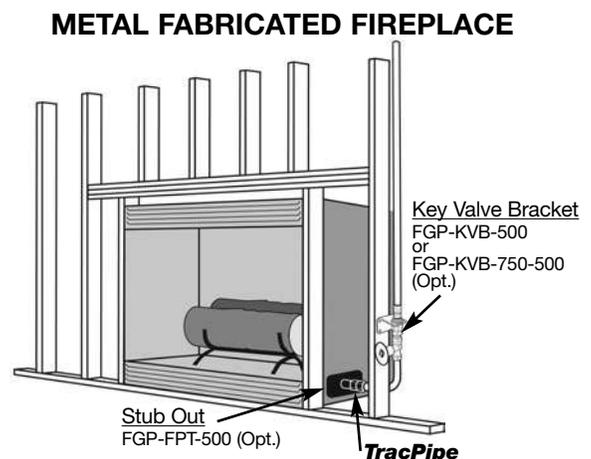
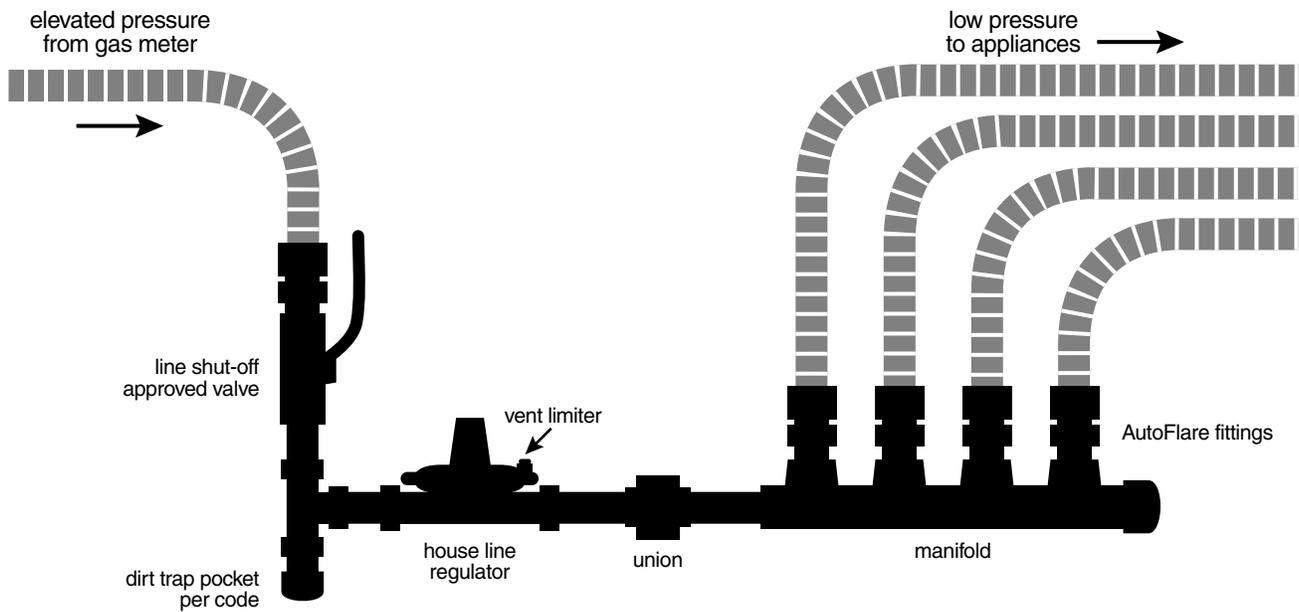

Figure 4-24



SECTION 4.7 — MANIFOLD & REGULATOR STATION

The use of a central manifold and regulator station is recommended for elevated pressure systems which are typically installed in a parallel arrangement to take advantage of the capacity of the regulator, which is sufficient for several appliances. Manifolds are available with the **TracPipe** system, or the use of black iron pipe and tee fabricated manifolds is permitted with this system. The manifold/regulator station should be located near by the largest gas consuming appliances, typically the furnace or boiler and the water heater in order to allow short runs to these units.

The manifold station **MUST** be located in an accessible location because of the shut-off valve(s) and regulator it contains. The manifold station may be contained in an enclosure box called a gas load center. Optional gas shut-off valves may be mounted on the manifold for each appliance run.

Manifolds installed on low pressure systems or in locations removed from the regulator may be concealed.

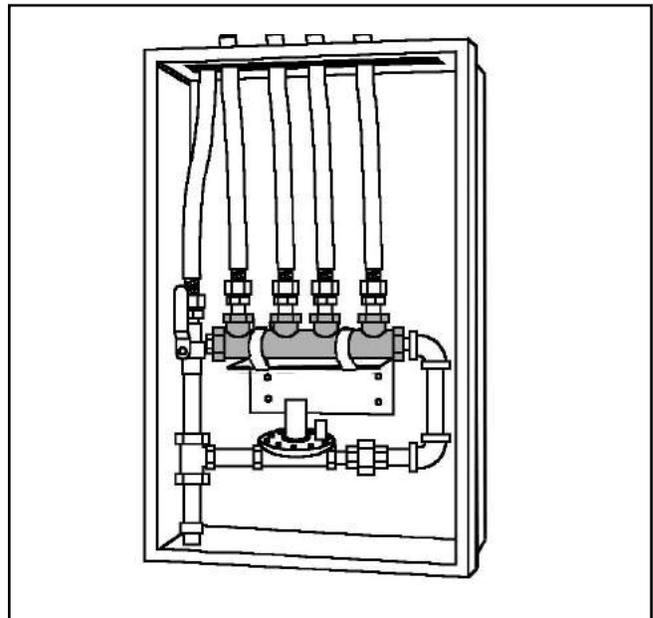

Gas Load Center

SECTION 4.8— REGULATORS AND ELEVATED PRESSURE SYSTEMS

A tubing system used at gas pressures exceeding 1/2 PSI but serving appliances rated for 1/2 PSI maximum, shall contain a pounds-to-inches regulator to limit the downstream pressure to no more than 1/2 PSI. The regulator must incorporate a lock-up feature limiting downstream pressure to 1/2 PSI under no flow conditions. The regulator shall comply with the applicable provisions of ANSI Z21.18 or CAN 1-6.3-M82.-ANSI Z21.80

Regulators used to reduce elevated system pressures for use by appliances must also conform to the following:

1. Must be sized to supply the required appliance load.(see chart below)

Capacities and Pressure Drop
 Nat. Gas 0.64 Specific Gravity
 Pressure Drop through Regulator

P/N	7" w.c.	1/2 psi	3/4 psi	1psi
FGP-REG-3	145	204	250	289
FGP-REG-5A	338	476	583	673
FGP-REG-7L	690	972	1191	1375

2. Must be equipped with an acceptable vent limiting device, supplied by the manufacturer, or be capable of being vented to the outdoors. The vent-limiting device can be used when the regulator is installed in a ventilated area. OMEGAFLEX ships all REG-3 & REG-5A regulators with vent-limiters installed. Vent-limiters are not available for REG-7 series regulators.

NOTE: For outdoor venting, the line must be at least the same size as the regulator vent connection, and cannot exceed a length of 30 feet. The vent shall be designed to prevent entry of water, insects or other foreign materials that could cause blockage of the line. **DO NOT VENT TO APPLIANCE FLUE OR BUILDING EXHAUST SYSTEM. DO NOT VENT TO PILOT LIGHT.**

3. MUST BE INSTALLED IN ACCORDANCE WITH MANUFACTURERS INSTRUCTIONS.

WHEN A VENT-LIMITER IS USED THE REGULATOR MUST BE MOUNTED IN AN UPRIGHT POSITION. INSTALL THE REGULATOR PROPERLY WITH GAS FLOWING AS INDICATED BY THE ARROW ON THE CASTING.

4. Must be installed in a fully accessible area with an approved shut off valve ahead of regulator. An optional union will enable removal of the regulator if the location does not otherwise permit removal for servicing. The ability of the autoflare fitting to allow disassembly and reattachment provides for regulator removal in most instances.
5. Line regulators do not vent gas under normal operating conditions. Any regulator found to be venting gas should be replaced immediately. Vent-limiters are required to limit venting in the event of a diaphragm failure, within the regulator, to limits identical to those imposed on a gas appliance control valve.
6. An area is considered to be ventilated if the combustion, ventilation or dilution air is obtained from the occupied areas of the building, or from outside, or from both, into the common areas of the appliance locations. Reference applicable codebook for details.
7. For outdoor installations remove the vent limiter and mount regulator with the vent outlet pointing down to prevent the entrance of water. A plastic cap FGP-CAP-3 is available for outdoor installations permitting regulator to be mounted in an upright position.

SECTION 4.8A REGULATOR ADJUSTMENTS

1. Regulators can be adjusted to deliver different outlet pressures within a limited range. The range is determined by the spring installed.
2. Adjustment can be accomplished by first removing the regulator seal cap to expose the adjusting screw. Turning the screw clock-

wise will increase outlet pressure, turning it counter-clockwise will decrease pressure.

- If spring adjustment will not produce desired outlet pressure, check to make sure supply pressure is at least equal to desired outlet pressure plus pressure drop of the regulator. If supply pressure is ade-

quate, consult factory if adjustment still can not be made. Do not continue to turn regulator adjusting screw clockwise if outlet pressure readings do not continue to increase. THIS MAY RESULT IN OVER-FIRING DUE TO LOSS OF PRESSURE CONTROL, SHOULD THERE BE A SUBSEQUENT INCREASE IN INLET PRESSURE.

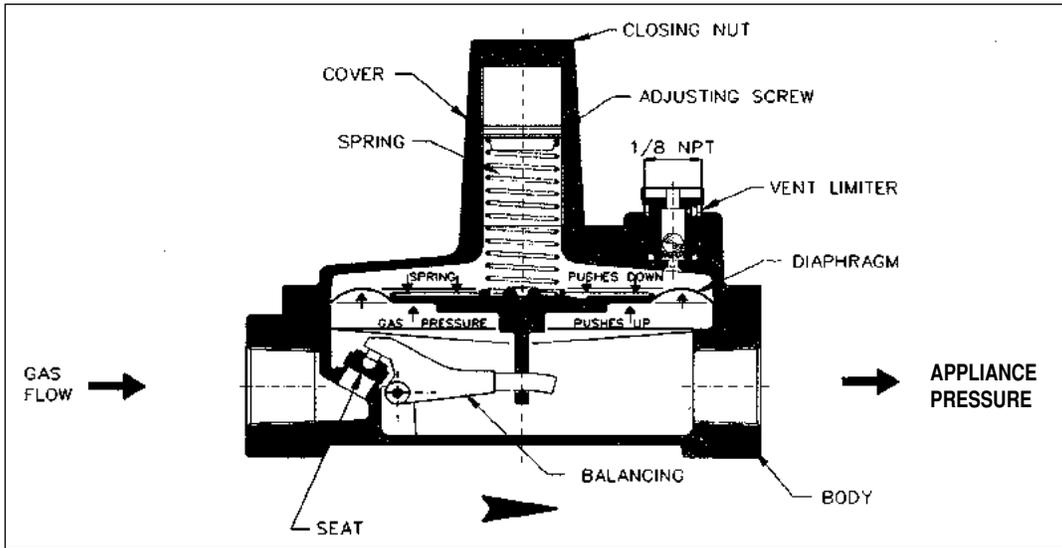

SECTION 4.8B REGULATOR CAPACITIES AND PRESSURE DROP FOR SINGLE AND MULTIPLE APPLIANCES

NATURAL GAS 0.64 SPECIFIC GRAVITY

REGULATOR CAPACITIES expressed in CFH (m³/h) 0.64 Specific Gravity Gas

Regulator Description	Part Number	NPT SIZE	Maximum Individual Load (Single Appliance)	Total Load (Multiple Appliances) @ PRESSURE DROP ACROSS REGULATOR			
				7.0" w.c. (17 mbar)	1/2 psi (34 mbar)	* 3/4 psi (52 mbar)	1 psi (69 mbar)
2 psig	FGP-REG-3	1/2"	140	145 (4.0)	204 (5.8)	250 (7.0)	289 (8.2)
2 psig	FGP-REG-3P	1/2"	140	145 (4.0)	204 (5.8)	250 (7.0)	289 (8.2)
2 psig	FGP-REG-5A	3/4"	300	338 (9.6)	476 (13.5)	583 (16.5)	673 (19.1)
2 psig	FGP-REG-5P	3/4"	300	338 (9.6)	476 (13.5)	583 (16.5)	673 (19.1)
2 psig	FGP-REG-7L	1-1/4"	900	690 (19.5)	972 (27.6)	1191 (33.8)	1375 (39.0)
5 psig w/ OPD	FGP-REG-3L47	1/2"	125 (3.5)	135 (3.8)	195 (5.5)	**	**
5 psig w/ OPD	FGP-REG-3L48	1/2"	200 (5.7)	160 (4.5)	225 (6.4)	**	**
5 psig w/ OPD	FGP-REG-5AL48	3/4"	320 (9.1)	325 (9.2)	465 (13.2)	**	**
5 psig w/ OPD	FGP-REG-5AL600	3/4"	425 (12.0)	345 (9.8)	490 (13.9)	**	**
5 psig w/ OPD	FGP-REG-5AL601	1"	465 (13.2)	375 (10.6)	535 (15.1)	**	**

* Recommended sizing column (3/4 psi Regulator drop) for 2 psig TracPipe installations refer to Table N-5 Section 7.0.

** For additional capacity and pressure drop information of 5 psig regulator w/ OPD consult factory or regulator manufacturer.

PROPANE 1.53 SPECIFIC GRAVITY

REGULATOR CAPACITIES expressed in CFH (m3/h) 1.53 Specific Gravity Gas

Regulator Description	Part Number	NPT SIZE	Maximum Individual Load (Single Appliance)	Total Load (Multiple Appliances) @ PRESSURE DROP ACROSS REGULATOR			
				7.0" w.c. (17 mbar)	1/2 psi (34 mbar)	* 3/4 psi (52 mbar)	1 psi (69 mbar)
2 psig	FGP-REG-3P	1/2"	90 (2.5)	94 (2.6) (237 MBTUh)	132 (3.8) (333 MBTUh)	161 (4.5) (406 MBTUh)	186 (5.3) (469 MBTUh)
2 psig	FGP-REG-5P	3/4"	194 (5.5)	218 (6.2) (549 MBTUh)	307 (8.7) (774 MBTUh)	376 (10.7) (948 MBTUh)	434 (12.4) (1094 MBTUh)
2 psig	FGP-REG-7L	1-1/4"	581 (16.5)	445 (12.6) (1121 MBTUh)	627 (17.9) (1580 MBTUh)	768 (21.9) (768 MBTUh)	887 (24.2) (2235 MBTUh)

* Recommended sizing column (3/4 psi Regulator drop) for 2 psig TracPipe installations refer to Table P-3 Section 7.0.

CAUTION: RECENT CODE CHANGES REQUIRE the use of 5 PSI LABELED REGULATORS IN 5 PSI SYSTEMS. REGULATORS LABELED 2 PSI ARE NOT APPROVED FOR 5 PSI USE.

NOTE: At supply pressures in excess of 2 PSI, the new ANSI Z21.80 Line Regulator Standard requires a means (an Over-Pressure protection device / OPD) - approved and tested with 5-PS or 2-5 PSI Labeled regulator - to limit the downstream pressure to 2-PSI maximum, in the event of regulator failure.

CONSULT THE REGULATOR MANUFACTURER FOR ADDITIONAL CAPACITY & PRESSURE DROP INFORMATION FOR A COMBINATION OF 5-PSI REGULATOR AND OPD.

SECTION 4.8C — OVER-PRESSURE PROTECTION

At supply pressures in excess of 2-psi the ANSI Z21.80 line regulator standard requires a means - an over-pressure protection device (OPD)-approved and tested with the regulator- to limit the downstream pressure to 2-psi maximum, in the event of regulator failure.

To comply with the ANSI Standard and with all codes adopted in the US and Canada, all installations exceeding 2-psi (primarily 5-psi systems, but including all other elevated pressure installations higher than 2-psi nominal) require a tested and approved overpressure protection device for use with the pounds-to-inches regulator. This requirement applies to line regulators but not to appliance regulators.

Regulators for 5 PSI Systems must be shipped as an assembled unit from our factory, regulator with OPD attached. Consult the current **TracPipe** Price List for information regarding part numbers and capacity.

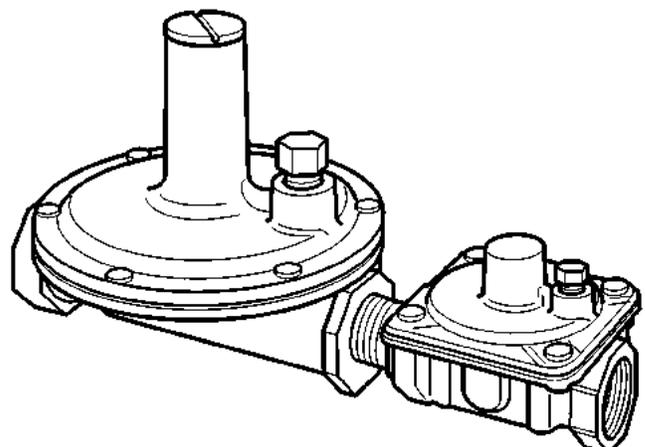

regulator with OPD attached

SECTION 4.9 — UNDERGROUND INSTALLATIONS

1. CODE REQUIREMENTS

When gas piping runs are located below grade in contact with earth or other material that could corrode the piping, codes require that the gas piping shall be protected against corrosion.

When piping is installed underground beneath buildings, codes require that the piping shall be encased in a conduit sealed inside of the building and vented above grade to the outside. The conduit shall be designed to withstand the superimposed loads. **NO FITTINGS OR COUPLINGS ARE PERMITTED BENEATH BUILDINGS.**

2. REGIONAL/MODEL CODES

TracPipe PS (patented) and **PS-II** (patented) installations conform to the underground fuel gas installation requirements of:

The National Fuel Gas Code NFPA 54

The International Fuel Gas Code

The Uniform Plumbing Code 2003 UPC®

SECTION 4.9A — GUIDELINES FOR UNDERGROUND INSTALLATIONS

1. Lay **TracPipe PS/PS-II** in a trench. Install the gas piping on a continuous solid surface per code to the appropriate burial depth as defined in Table 4-6.

WARNING: TracPipe PS and PS-II Systems must only be installed by a qualified person who has been trained through the TracPipe Gas Piping Installation Program. All installations must comply with local code requirements and the instructions contained in the TracPipe Design and Installation Guide.

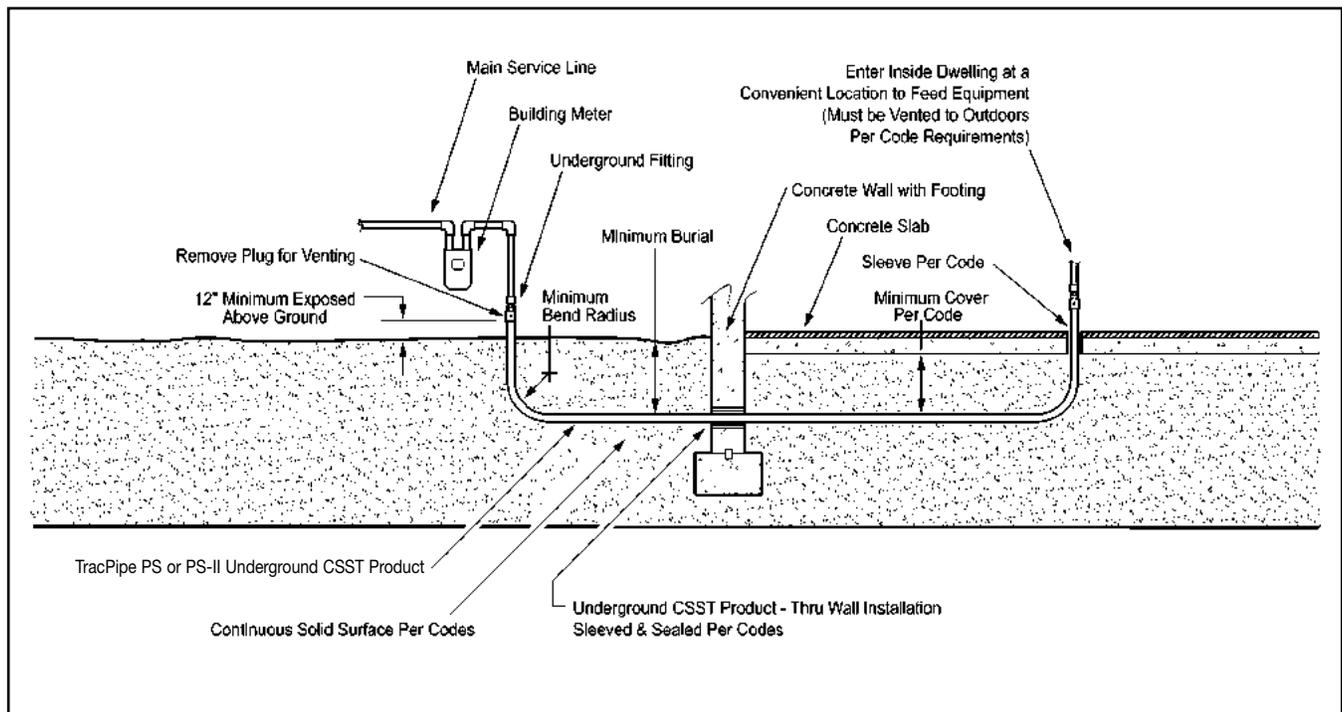

Figure 4-19

2. When transitioning **TracPipe PS/PS-II** from below grade or under slab to above grade, use the recommended minimum bend radius as shown in Figure 1 and depicted in Table 4.7 below.

TABLE 4.7

RECOMMENDED MINIMUM BENDING RADIUS FOR TracPipe PS/PS-II		
Tubing Size	Minimum Bend Radius R	
	PS	PS-II
3/8 inch	18 inches	6 inches
1/2 inch	18 inches	6 inches
3/4 inch	24 inches	8 inches
1 inch	30 inches	10 inches
1-1/4 inch	36 inches	12 inches
1-1/2 inch	48 inches	16 inches
2 inch	54 inches	18 inches

Note: For TracPipe PS Installations requiring a tighter bend radius than shown above, Flexible Poly Tubing is available. See Flexible Poly Tubing Instructions later in this document.

3. Recommended exposed clearance height (height to the **TracPipe** fitting above grade) is 24 inches minimum when terminating at this point. For vertical runs up the outside of a building in traffic areas, protect the **TracPipe** as explained in Section 4.3B.
4. Avoid bending the above grade vertical

portion of the **TracPipe PS/PS-II** piping beyond the Minimum Bend radius in Table 2. To make a tighter bend in order to line up for a wall penetration, use a rigid fitting such as a malleable iron 90.

5. **TracPipe PS/PS-II** is suitable for above ground installations and is resistant to U.V. exposure. Portions rising above grade should be rigidly supported by direct attachment to a wall or independent support, (e.g. metallic strut) or by connection to rigid downstream piping or fittings (e.g. at a meter or Propane second stage regulator)
6. When installing **TracPipe PS-II** underground through a foundation wall the space between the gas piping and the building shall be sealed to prevent entry of gas or water.
7. **TracPipe PS-II** can penetrate directly through a concrete slab unless other requirements are established by local codes concerning slab penetrations and firestop requirements.
8. **TracPipe PS-II** can be transitioned to standard **TracPipe** piping above grade using **TracPipe AutoFlare®** fittings with a **TracPipe PS-II** Coupling P/N FGP-UGC-SIZE. Remove the black plastic vent coupling on the standard **TracPipe** side.

TABLE 4.6

Minimum cover requirements for TRACPIPE PS/PS-II, Burial in inches (cover is defined as the shortest distance measured between a point on top surface of the outer sleeve and the top surface of finished grade, concrete or similar cover)	
Location of buried TracPipe PS/PS-II	Minimum cover for direct burial without concrete encasement
All locations not specified below	18 inches
In trench below 2-in thick concrete or equivalent	12 inches
Under a building with interior slab	4 inches
Under minimum of 4-in. thick concrete exterior slab with no vehicular traffic and the slab extending not less than 6-in beyond the underground installation	4 inches
Under streets, highways, roads, alleys, driveways, and parking lots	24 inches
One and two family dwelling driveways and parking lots and used only for dwelling-related purposes	18 inches
In or under airport runways, including adjacent areas where trespassing prohibited	18 inches

Note: When encased in concrete, the concrete envelope shall not be less than 2 inches thick.

Alternatively use a malleable iron coupling for the transition.

9. **TracPipe PS-II** must be transitioned above ground to standard **TracPipe** when routing through plenums or through penetration firestop installations. The black sleeve is not qualified for these locations.
10. Venting of **TracPipe PS/PS-II** shall be designed per local codes to prevent the entrance of water, insects or foreign materials.
11. Typical underground installations for Corrugated Stainless Steel tubing include, but are not limited to:
 - Pool and Spa Heaters
 - School Science Laboratories
 - Gas service to Outbuildings
 - Gas Lampposts and Grills

SECTION 4.9B — **TracPipe PS** FITTING ATTACHMENT INSTRUCTIONS

1. **TracPipe PS** uses standard **AutoFlare** fittings. To assemble fittings follow instructions found in the **TracPipe** Design Guide and Installation Instructions Section 4.2.
2. To install **TracPipe PS** for underground service, cut the black polyethylene sleeve in the same manner you would cut the 1-1/4" thru 2" size **TracPipe** product , with a standard tubing cutter Ridgid™ 152 or equal,

and a cutting wheel Ridgid™ catalog no. 33195 (Poly Wheel) (P/N E:5272). Note: For the 1-1/4" thru 2" size black polyethylene sleeving, the larger tubing cutter Ridgid™ no. 152 must be used due to the diameter of the sleeving. CAUTION: Do **NOT** use a hacksaw or other sawing device to cut the black polyethylene sleeving as it may damage the inner **TracPipe** gas piping.

3. Cut the **TracPipe** gas piping using the same tubing cutter per standard instructions in the Design and Installation Guide.
4. Slip the required heat shrink polyolefin cuff over the TracPipe gas piping to each end of the black polyethylene sleeving and heat shrink the polyolefin cuff to the gas piping and the black polyethylene using a heat gun or other suitable heat source. NOTE: Omegaflex®, Inc. recommends the use of a heat gun. Extreme care should be taken when applying heat to the polyolefin cuff as not to damage the **TracPipe** gas piping yellow jacket.
5. Where local codes require venting, slide plastic tee (P/N: FGP-VT-SIZE) over end of **TracPipe** and insert into end of the black polyethylene sleeve on the end of the run which is nearest to the outside wall of the building. Heat shrink the polyolefin tubing to the vent tee and to the TracPipe gas pipe.

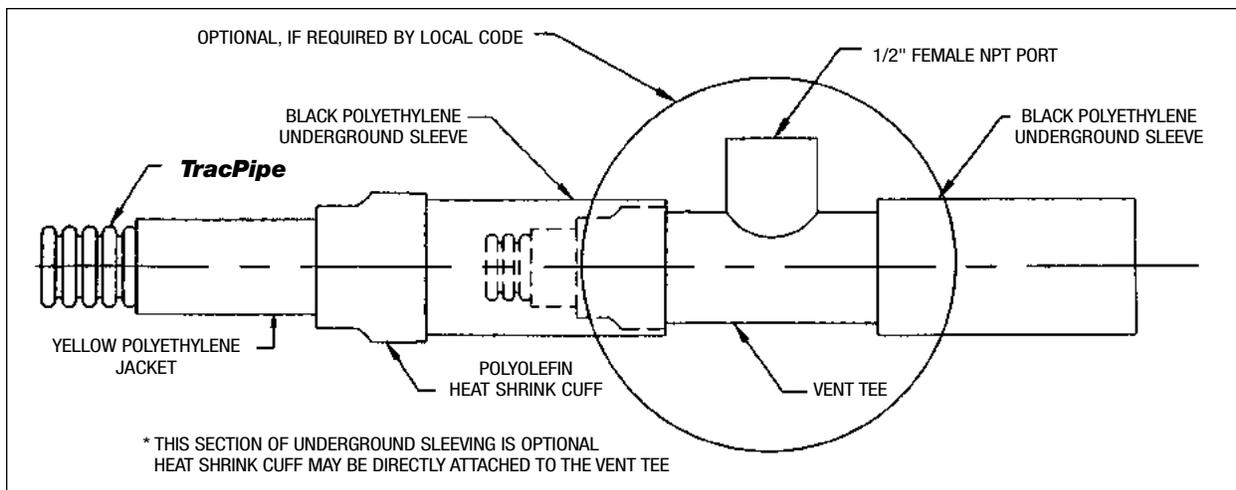

TracPipe PS with Vent Tee Installed

Figure 4-20

SECTION 4.9C — UNDERGROUND PS WITH FLEXIBLE POLY TUBING

Product Description: Flexible, corrugated polyethylene tubing in sizes to fit **TracPipe PS** (patented) underground gas piping. Poly tubing is easy to bend, providing flexibility at the ends of a length of **TracPipe PS** to facilitate transition to above ground. Use with available heat shrink cuffs and couplings to provide a completely sleeved underground gas piping system that can be easily vented when required by codes.

Installation Instructions

1. Determine the location where the smooth black sleeve will make the transition to flexible poly tubing. This is typically the transition point from below ground to above ground but can also occur above or below ground wherever a tight bend of up to 90 degrees is required.

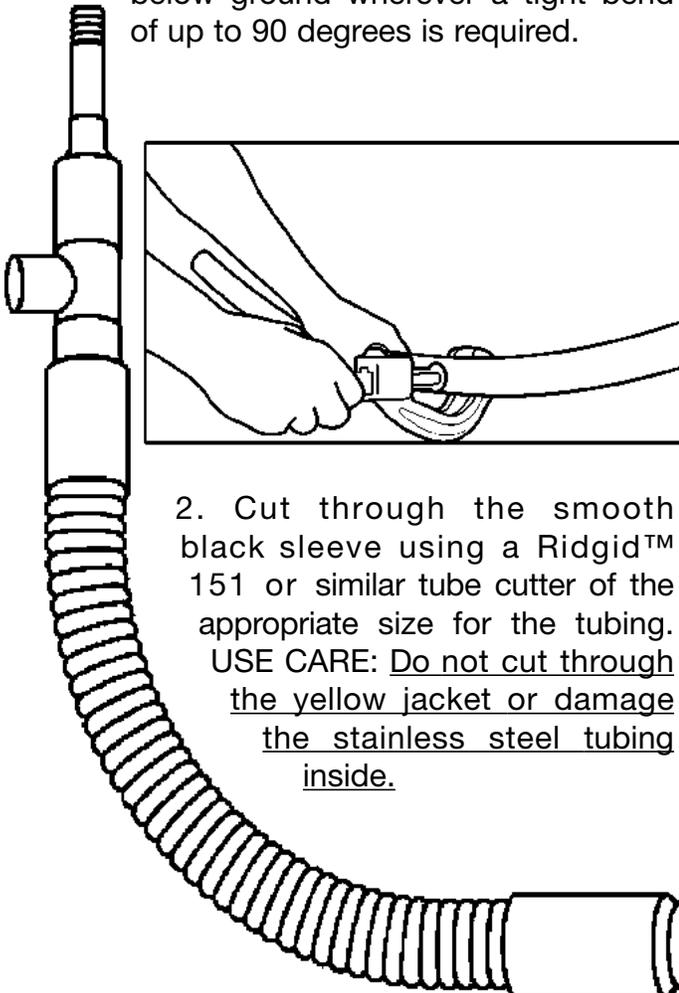

2. Cut through the smooth black sleeve using a Ridgid™ 151 or similar tube cutter of the appropriate size for the tubing. USE CARE: Do not cut through the yellow jacket or damage the stainless steel tubing inside.

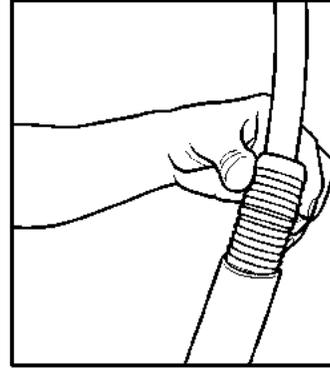

3. Insert a barbed coupling by sliding it over the exposed length of TracPipe and pushing firmly into the smooth black sleeve until all barbs are covered up to the coupling's center.

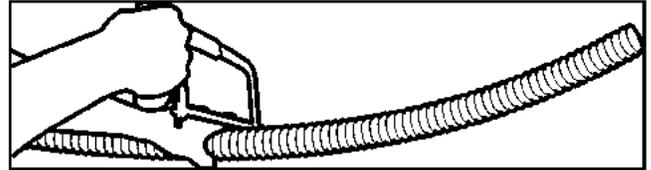

4. Cut flexible poly tube with a hack saw to approximately 1-1/2 times the trench depth. This will leave about one foot exposed above ground after backfill.

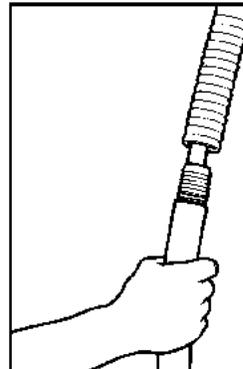

5. Slide cut section of flexible poly tube over the remaining barbs on the coupling.

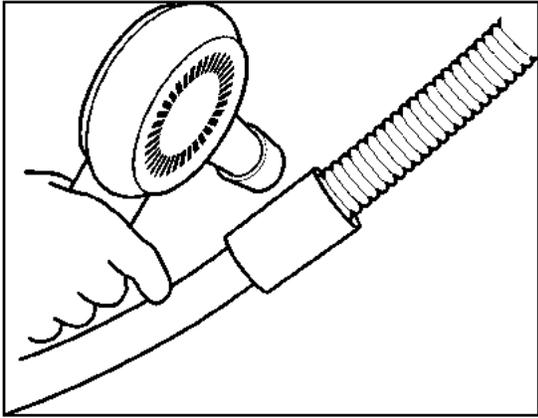

6. Position a section of heat shrink cuff material to cover the coupled smooth sleeve and corrugated sleeve. This cuff should be centered over the plastic barbed coupling and cover roughly two (2) inches of each black sleeve. NOTE: This cuff is internally treated with a thermal adhesive and cannot be removed without damage after the heat shrink operation.
7. Carefully shrink the cuff using a heat gun. As cuff is heated it will conform to the diameters of the sleeves and the thermal adhesive will set to lock the combined materials.
8. Above Ground, follow the preceding steps to install a plastic barbed tee for vented systems, or shrink a cuff directly onto the exposed **TracPipe** for non-vented installations. (Most codes require underground sleeving to be vented for under building slab installations such as island ranges).

TracPipe PS

Please read and follow all instructions and precautions in this document and TracPipe Design and Installation Guide (latest version) relative to installing the pre-sleeved version of OMEGAFLEX® TracPipe. The instructions contained on this sheet apply to the flexible poly tubing available as an optional accessory to facilitate tight bends.

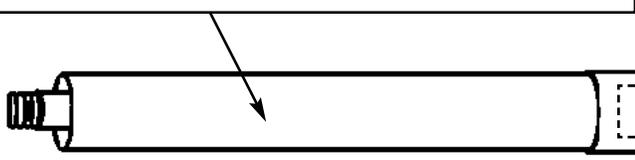

Sizing Chart for Flexible Poly Tubing

Part #	Description	Used In Conjunction With
FGP-UGFX-1.25	1-¼" Flexible Poly Tubing	3/8" & 1/2" TracPipePS
FGP-UGFX-1.50	1½" Flexible Poly Tubing	3/4" & 1" TracPipePS
FGP-UGFX-2.00	2" Flexible Poly Tubing	1¼" TracPipePS
FGP-UGFX-3.00	3" Flexible Poly Tubing	1-1/2" & 2" TracPipePS

All sizes available in maximum 100 foot coils

Typical Underground Installation using Flexible Poly Tubing

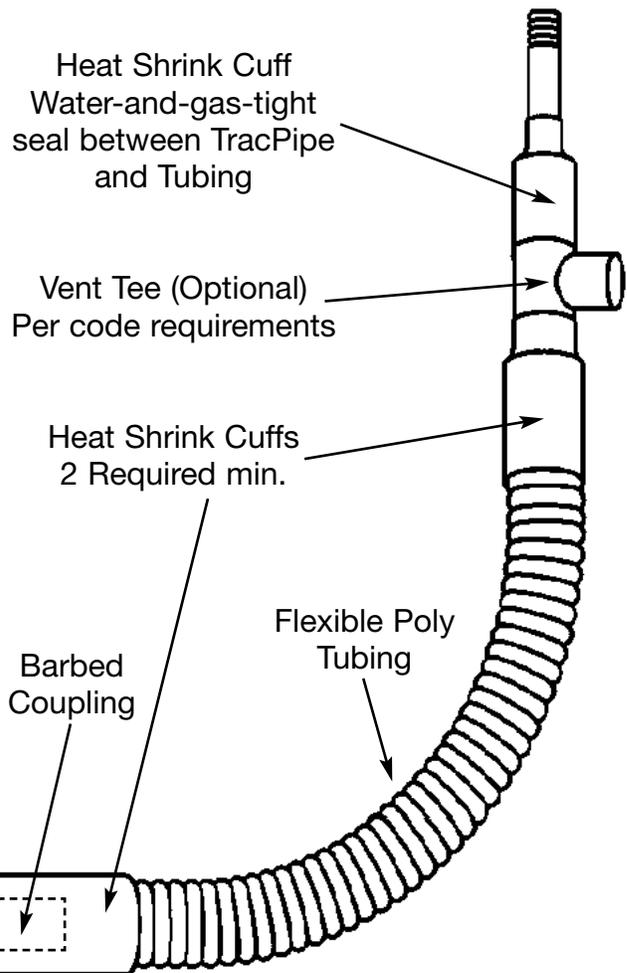

TracPipe PS-II Cut-Away

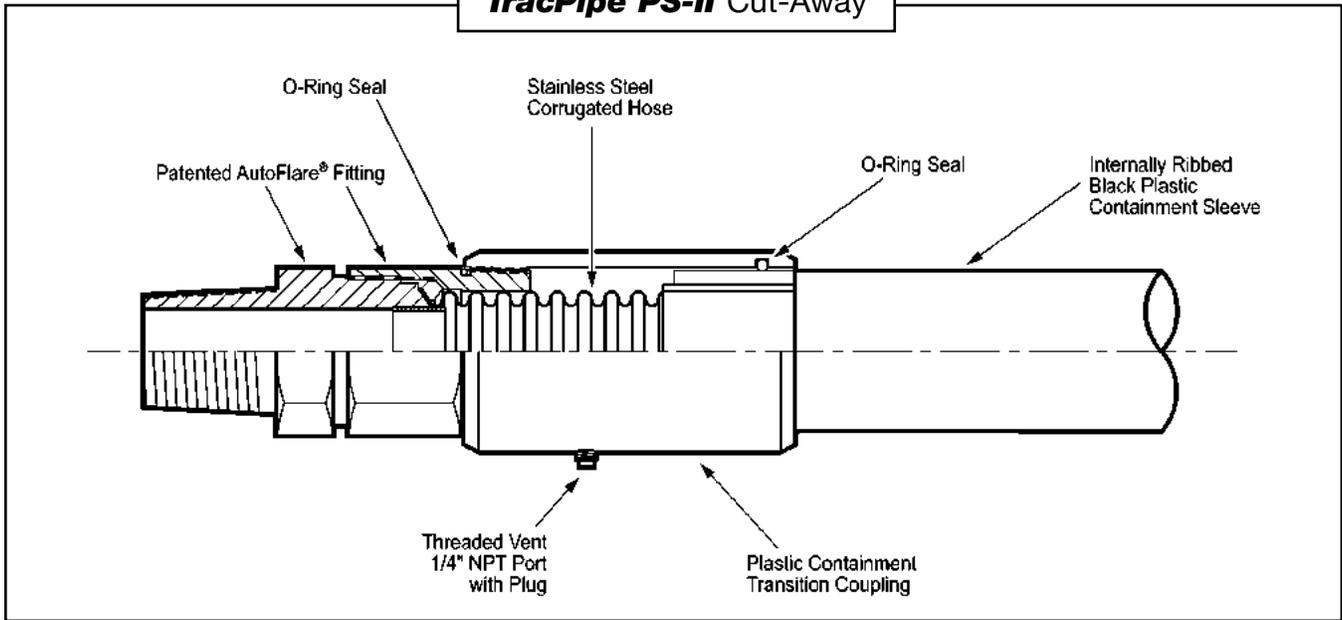

SECTION 4.9D — TRACPIPE PS-II

1. **TracPipe PS-II** is a patented system suitable for above ground and underground use. It is designed with our standard CSST tubing and incorporates an internally ribbed sleeve (conduit), and specially designed end fittings that provide vent capability at either end of a piping run in the event of a leak in the CSST.
2. **TracPipe PS-II** is IAPMO tested and UPC listed for underground use per IGC 201-2004, complies with all model code requirements for underground/under slab burial, and is CSA listed for above ground use. **Note:** The ANSI/CSA LC-1 Standard has no provisions for evaluating CSST for direct burial.
3. For above ground **PS-II** installations, the installer shall meet local building codes with respect to flame spread and smoke density regulations for nonmetallic materials. **PS-II** is not suitable for use in return air plenums or through penetration fire stop systems per UL classification requirements.
4. **TracPipe PS-II** is supplied in standard lengths on reels or custom cut lengths. Standard reel lengths are 100, 150, and 250 feet (100 foot lengths for sizes up to 1 inch.)
5. **TracPipe PS-II** lengths can be spliced together by using available couplings. All metallic portions of the fittings underground shall be mastic-wrapped to conform to local codes for under ground piping. Be certain prior to back-filling that no metallic portions of the piping system will be exposed to earth. **No fittings or couplings are permitted under building slabs.**
6. **NOTE:** When pressure testing **TracPipe PS-II**, it is necessary to remove at least one fitting vent plug to insure proper test results on the stainless steel tubing. Codes do not require pressure testing of the sleeve. If local jurisdictions require the sleeve to be tested, do not exceed the pressure of the pipe (25 psi maximum).

SECTION 4.9E — TRACPIPE PS-II FITTING ATTACHMENT

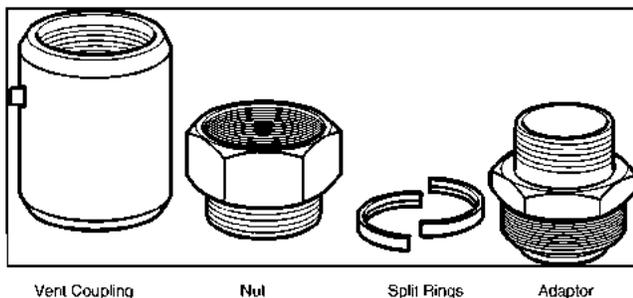

1. **TracPipe PS-II** is constructed from Omegaflex standard TracPipe Stainless Steel Flexible Gas Pipe sleeved in a fully vent-capable polyethylene sleeve.

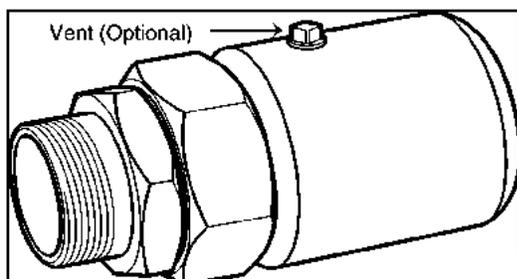

2. **TracPipe PS-II** fittings are constructed from TracPipe patented AutoFlare fittings with a plastic containment coupling and 1/4" NPT vent port. Fittings assemble without special tools.
3. **NOTE:** When pressure testing **TracPipe PS-II**, it is necessary to remove at least one fitting vent plug to insure proper test results on the stainless steel tubing.

Tools Required for Assembly

- * Utility knife with sharp blade
- * Appropriate size Adjustable or Monkey Wrenches
- * Tubing Cutter:
For up to 3/4" -#151 Ridgid® Tubing Cutter (FGP-TC-151) w/TracPipe Cutting Wheel (FGP-E-5272)
For 1" and up -#152 Ridgid® Tubing Cutter (FGP-TC-152) w/TracPipe Cutting Wheel (FGP-E-5272)
- * Reciprocating Saw or Hacksaw

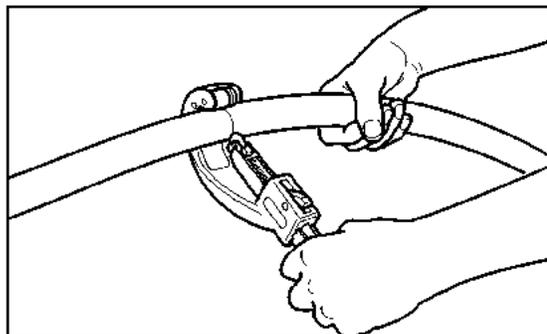

1. Unreel pipe into trench or on the ground and cut to desired length-plus one foot. Cutting up to 1" size can be done with a large tubing cutter. For 1-1/4" - 2" sizes, a reciprocating saw is recommended.

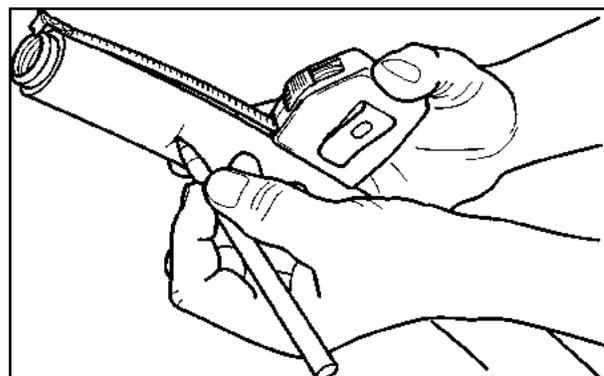

2. Mark the sleeve at specified length on the Strip Length Chart (below) - plus 2".

Table 4-8
Jacket Strip Length / Fitting Torque / Superimposed Loading Chart

Size	3/8	1/2	3/4	1	1-1/4	1-1/2	2
Jacket Strip Length	1-1/2"	1-1/2"	1-3/4"	2"	2-1/4"	2-1/2"	2-3/4"
Fitting Torque Value	40 ft-lb	42 ft-lb	45 ft-lb	75 ft-lb	150 ft-lb	200 ft-lb	250 ft-lb
OD for Core Hole Sizing	.820	1.08	1.32	1.6	1.96	2.18	2.8
Max. Superimposed Loading <i>psf</i>	9640	7254	5409	4203	3390	2901	2124

Notes: 1. Super-imposed loading includes all dead load and live load combinations.
2. Maximum buried depth of 36"; 3. Soil Density : 120 pcf; 4. Factor of safety used: 4.

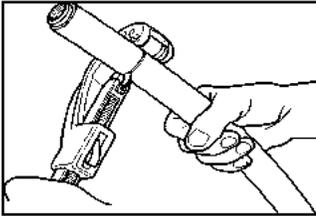

- Using the appropriate tubing cutter with TracPipe #FGP-E-5272 cutting wheel, score the black sleeve approximately half of the way through. Use extreme care not to cut or score the stainless corrugated pipe! Typically, no more than two turns in on the cutter is sufficient.

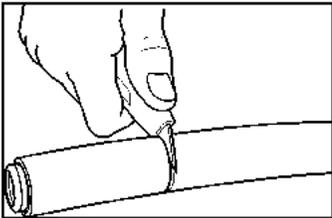

- Finish cutting through the sleeve down to the stainless corrugated pipe using a sharp utility knife.

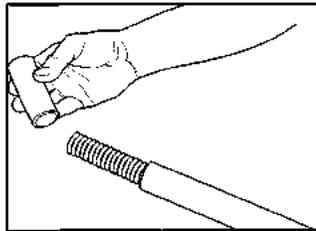

- Using a twisting motion, remove the black sleeve from the pipe. It may be necessary to cut sleeve longitudinally and peel off for larger sizes.

Inspect stainless pipe for scoring from the tubing cutter.

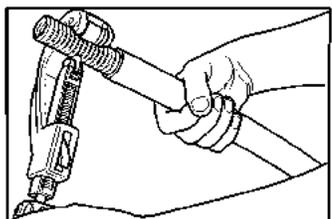

- Using the tubing cutter, trim corrugated pipe to strip length specified on chart. Cut slowly in the root of the corrugation in the same manner you would cut copper tubing. Inspect end of pipe for a clean cut without tears in corrugation.

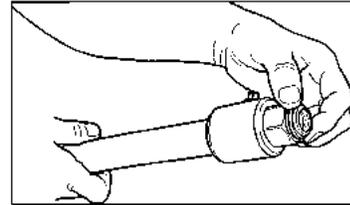

- Remove adapter and split rings from fitting. Attach adapter to equipment. Slip coupling and nut over end of pipe all the way to expose first corrugations of pipe. Insert split rings into first corrugation as shown.

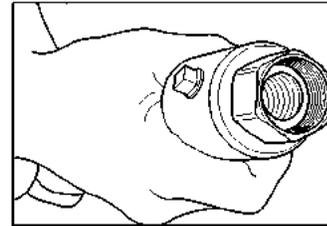

- Holding the black coupling, slide fitting up to capture split rings into nut. Be sure split rings slip all the way to the base of the internal threads. Assembly is now ready to be attached to the adapter on the equipment.

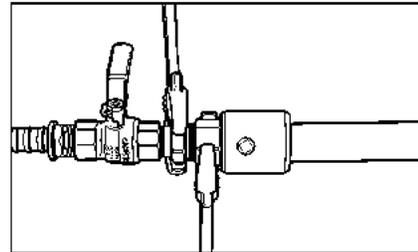

- Thread nut onto adapter previously installed on the equipment. Using appropriate wrenches, hold adapter and tighten nut to proper torque specified. Do not over tighten or use any pipe dope or thread sealants on this connection. This is a metal-to-metal seat and will not seal if pipe dope or thread sealants are used. Sealants are to be used on the NPT connection to the equipment only!

NOTE: When installing coupling FGP-UGC-SIZE the same instructions apply, except metallic parts of the fitting must be wrapped in a code approved manner (e.g. mastic used for wrapping metallic pipe).

SECTION 4.10 — ELECTRICAL BONDING/GROUNDING



WARNING! FIRE / FUEL GAS PIPING

The **TracPipe**® flexible gas piping **MUST** be bonded to an effective ground-fault current path per NFPA 54 in accordance with the instructions contained in this section.

It is **HIGHLY RECOMMENDED** to equipotentially bond all mechanical systems to the building's grounding electrode.

1. Definitions:

Grounding: The process of making an electrical connection to the general mass of the earth. This is most often accomplished with ground rods, ground mats or some other grounding system. Low resistance grounding is critical to the operation of lightning protection techniques.

Bonding: The process of making an electrical connection between the grounding electrode and any equipment, appliance, or metal conductor: pipes, plumbing, flues, etc. Equipment bonding serves to protect people and equipment in the event of an electrical fault.

Equipotential Bonding: The process of making an electrical connection between the grounding electrode and any metal conductor: pipes, plumbing, flues, etc., which may be exposed to a lightning strike and can be a conductive path for lightning energy towards or away from the grounding electrode.

2. The **TracPipe**® gas piping system shall be bonded in accordance with the National Fuel Gas Code, NFPA 54/ANSI Z223. The piping system is not to be used as a grounding conductor or electrode for an electrical system.

SECTION 4.10A COUNTERSTRIKE® INSTALLATION INSTRUCTIONS

for all products date coded 0731 and higher (manufactured after July 30, 2007)

1. **CounterStrike**® CSST with the black, protective sleeve uses the same easy to install **AutoFlare**® fittings as conventional **TracPipe**® with the yellow jacket. **CounterStrike**® systems are sized in the same manner as **TracPipe**® either using Capacity Tables or other approved methods.
2. The instructions for cutting the tubing and for making fitting connections to **CounterStrike**® are identical to standard yellow-jacketed **TracPipe**®. The jacket shall remain intact as much as practical when attaching the fitting.
3. There are no special installation requirements for **CounterStrike**® date coded 0731 and higher. The bonding requirements for **CounterStrike**® are per National Electrical Code NFPA 70 and the National Fuel Gas Code NFPA 54.
4. **CounterStrike**® date coded 0731 and higher meets building code requirements (ASTM E84) with respect to flame spread and smoke density. This permits installation in drop ceilings used as return air plenums.
5. **CounterStrike**® date coded 0731 and higher has thru penetration UL classifications for 1, 2, 3 and 4 hours with the black jacket intact.

SECTION 4.10B — BONDING CONVENTIONAL YELLOW-JACKETED TRACPIPE

1. For bonding of the conventional yellow-jacketed **TracPipe**® system, a bonding clamp must be attached to the brass AutoFlare® fitting adapter (adjacent to the pipe thread area – see Figure 4-21) or to a black pipe component (pipe or fitting) located in the same electrically continuous gas piping system as the AutoFlare® fitting. The corrugated stainless steel portion of the gas piping system SHALL NOT be used as the bonding attachment point under any circumstances. Bonding electrode conductor sizing shall be in accordance with NFPA 70 Article 250 (Table 250-66) Paragraph (A).

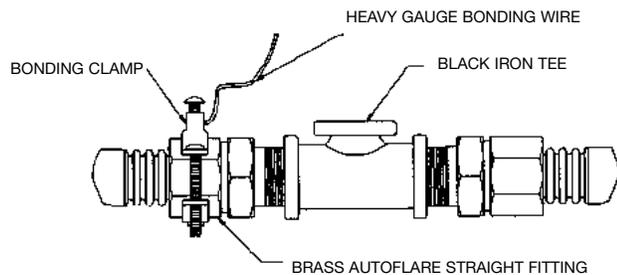

Figure 4-21

BRASS BONDING CLAMPS

TracPipe AutoFlare FITTING SIZE RANGE	BONDING CLAMP SIZE	PART NO. OR EQUAL (Bridge Port)
3/8" & 1/2" & 3/4"	1/2" & 3/4"	1309-B
1"	1-1/4"	1313-B
1-1/4"	2"	1314-B
1-1/2"	2-1/2"	1314-B
2"	3"	1315-B

IMPORTANT SAFETY PRECAUTION

- Failure to properly bond the conventional yellow-jacketed **TracPipe**® flexible gas piping may lead to damage to the CSST system in the event of a lightning strike.
- The lightning may arc to or from another metal system, creating a hole in the wall of the **TracPipe**® CSST.
- This presents a risk of fire in the building, and could lead to serious personal injury or significant property damage.

2. Lightning is a powerful and unpredictable natural force, and it has the capacity of damaging gas piping systems due to arcing between the gas piping system and other metallic systems in the building.
3. If the building to be piped is in a high lightning flash density area or a region with a high number of thunderstorm days per year, (Figure 4-22) consideration should be given to utilizing the Lightning Risk Assessment method given in Annex L of NFPA 780 for a determination of the need for a lightning protection system.

Notes:

- a. If possible, avoid running the bonding jumper a long distance through the building. The connection should be as short as possible. Gas meter should be near the electrical service if possible. If not, the bond can be connected at any point near the electrical service per Figure 4-21.
- b. Lightning induced voltages seeking ground are subject to impedance; utilize a braided or stranded bonding jumper for greater surface area, rather than solid wire.
- c. Upon completion of the conventional yellow-jacketed **TracPipe**® Gas Piping System installation and prior to gas service initiation, check to see if the bonding has been completed.
- d. Routing of gas piping should be as low in the structure as reasonably possible for best performance.
- e. **TracPipe**® CSST runs, including **CounterStrike**®, should be installed with a bend radius of 8 inches or more whenever possible; this will reduce the possibility that energy will jump from the piping to other conductive surfaces.

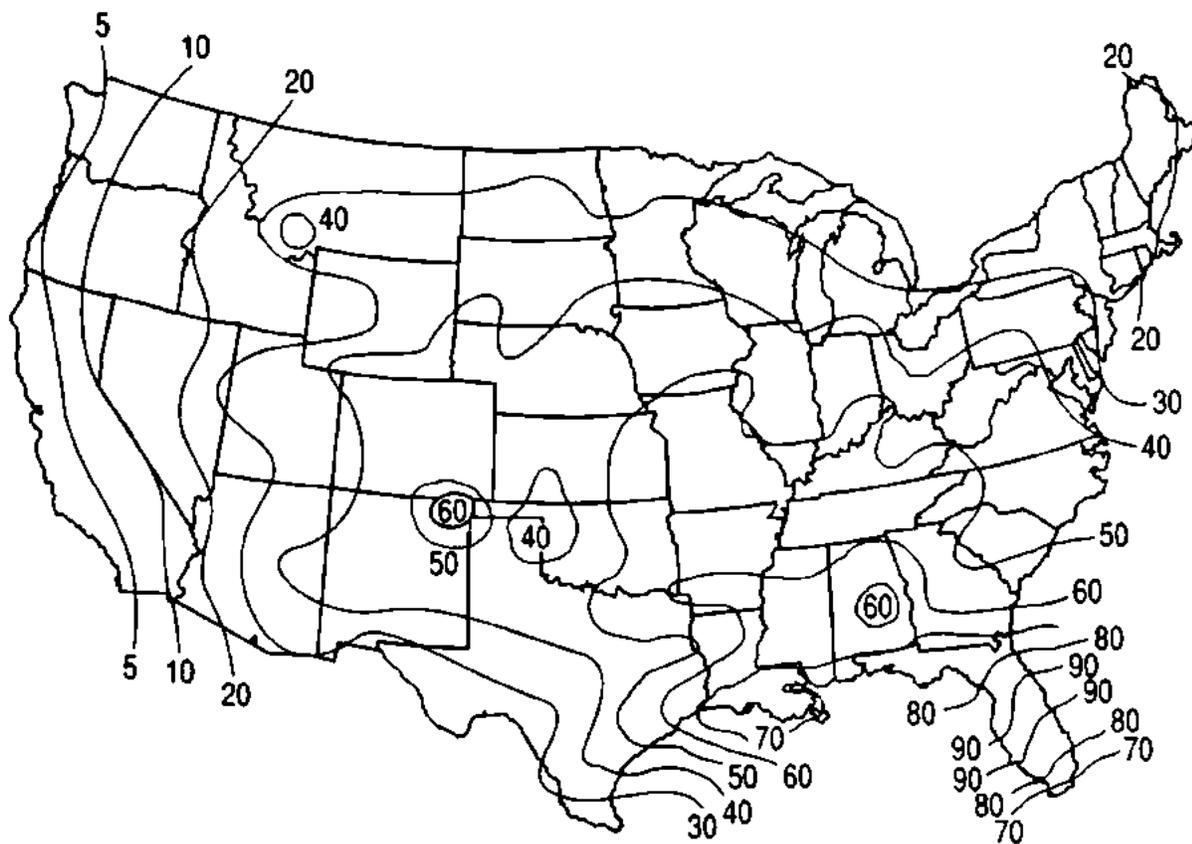

Average Number of Thunderstorm Days per Year

Figure 4-22

CHAPTER 5

INSPECTION, REPAIR AND REPLACEMENT

SECTION 5.1 — MINIMUM INSPECTION REQUIREMENTS

TracPipe[®] Inspection Checklist

All installations shall be inspected by the jurisdiction having authority in accordance with state and local mechanical/plumbing codes and the National Fuel Gas Code NFPA 54 (ANSI Z 223.1).

- Installer qualified per state and/or local requirements.
- Installer has **TracPipe** Training Certification card.
- Inspection and pressure test completed at rough in.
- Strike protection in place where required.
- TracPipe**[®] or **CounterStrike**[®] system is bonded to grounding electrode.

RECOMMENDED

- Installation of equipotential bonding between grounding electrode and all mechanical systems.

TracPipe Flexible Gas Piping
OMEGA FLEX[®] INC.
451 Creamery Way, Exton, PA 19341-2509
Toll free: (800) 671-8622
Tel: (610) 524-7272
Fax: (610) 524-7282

SECTION 5.2 — REPAIR OF DAMAGED PIPING

If the tubing is damaged, refer to the following sections to determine the severity of damage and, if necessary, the method of repair.

1. No repairs or replacement of the tubing is necessary if the tubing is only slightly dented due to impact or crushing as indicated in Figure 5-1.
2. The tubing must be replaced under the following circumstances:
 - a. The tubing has been significantly crushed or dented (Figure 5-2)
 - b. The tubing has been damaged by puncture of any kind, i.e., nails, screws, drill bits, etc.
 - c. The tubing has been bent beyond its minimum bend radius so that a crease or kink remains. (Figure 5-3)

METHOD OF REPAIR

A line splice can be made using an autoflare coupling, but if the tubing run is short and easily accessible, the preferred repair method is to replace the entire length. Tubing run can often be replaced faster than repairing the damaged section with a splice and this does not add any additional fitting joints to the system. The Auto Flare fittings can be re-attached to the new tubing run

1. Where repairs or replacements involve Corrugated Stainless Steel Tubing systems of different manufacturers, the systems can be joined again through standard pipe couplings and the appropriate CSST fittings.

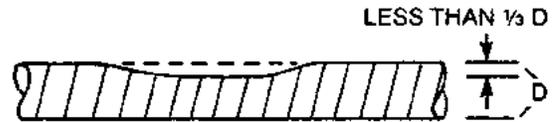

Figure 5-1 – Repair Unnecessary. No Significant Damage to the Tubing Due to Impact or Crushing

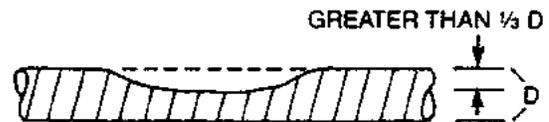

Figure 5-2 – Repair Necessary. Significant Damage to the Tubing Due to Impact or Crushing

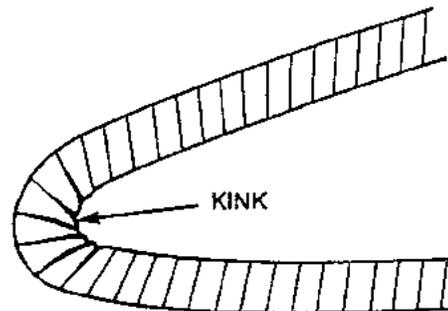

Figure 5-3 – Repair Necessary. Damage Due to Bending Beyond Minimum Bend Radius

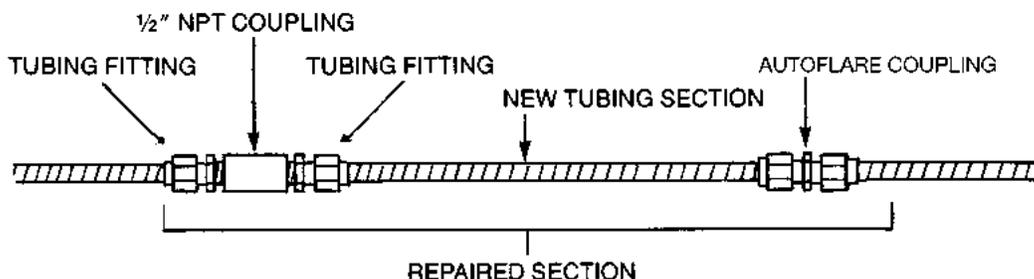

Figure 5-4 – Repair of Damaged Tubing with a New Section of Tubing and a joint splice or an AutoFlare Coupling

CHAPTER 6

PRESSURE/LEAKAGE TESTING

SECTION 6.0 — PRESSURE TEST PROCEDURE

The final installation must be inspected and tested for leaks at 1 1/2 times the maximum working pressure, but not less than 3 PSI, using the procedures specified in Part 4 “Inspection, Testing and Purging” of the National Fuel Gas Code*, NFPA 54/ANSI Z223. 1-1996* or subsequent editions of this code in effect at the time of the test. Pressure test according to these guidelines or to local codes. When local codes are more stringent, local codes must be followed. If no local codes apply, test according to the National Fuel Gas Code. The installer should never pressure test above 10 PSI with the pounds-to-inches regulator installed. This may damage the regulator.

1. Pressure testing should be performed during rough construction of the facility before interior walls are finished. This will permit a more complete inspection of the piping system during the pressure testing, and save costly rework in the event of leaks or other problems. **TracPipe** is not responsible for repairs necessary to correct defects discovered after interior walls are finished.
2. Do not connect appliances or pressurize the system with fuel gas until after the pressure test is completed.
3. All gas outlets for appliance connections should be capped during pressure testing.
4. **USE ONLY NON-CORROSIVE LEAK CHECK SOLUTIONS.** Rinse with water and dry the tubing thoroughly after leak detection. (Available: TracPipe Leak Check Solution P/N FGP-LCS)

5. Most utilities perform a leak test after setting the gas meter and prior to turning on the gas. This test is performed after the final construction is complete and finished interior walls are in place. This test is performed to assure no damage was done to the tubing during the closing-in construction process.
6. **NOTE:** When pressure testing **TracPipe PS-II**, it is necessary to remove at least one fitting vent plug to insure proper test results on the stainless steel tubing. Codes do not require pressure testing of the sleeve. If local jurisdictions require the sleeve to be tested, do not exceed the pressure of the pipe (25 psi maximum).

SECTION 6.1 — Pressure Test for Elevated Pressure Systems

NOTE: DO NOT SUBJECT *TracPipe* SIZES 1-1/2" OR 2 INCH TO EXCESSIVE PRESSURE.

Pressure Test 1-1/2" and 2" sizes to local code requirements but not to exceed 40 psi. In the absence of code requirements, test to 1-1/2 times actual working pressure, not to exceed 40 psi.

The 2-5 PSI system requires a two-part pressure test. (See Figure 6-1) The first part is performed on the elevated pressure section, between the meter connection and the pounds-to inches house line regulator.

The second part is performed on the low pressure section, between the pounds-to-inches house line regulator and the gas appliance outlet. If a steel pipe “jumper” is inserted in place of the house line regulator the entire system can be pressure tested in one step.

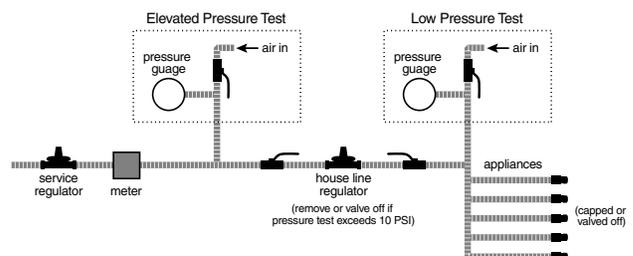

*To obtain a copy of the National Fuel Gas Code write to: National Fire Protection Association, Battery March Park, Quincy, MA 02269-9904 or call: 1-800-344-3555

Figure 6-1 – Pressure Test Requirement for a 2 PSI System

SECTION 6.1A — APPLIANCE CONNECTION LEAKAGE CHECK PROCEDURE

1. After the final pressure test, inspection and final construction is complete (finished interior walls) connect the appliances to the tubing system.
2. This final connection can be accomplished by a stainless steel flexible connector, direct connection with CSST tubing or with rigid black pipe. See section 4.6 for installation details and guidelines.
3. Turn the gas on at the meter and inspect for leakage before operating the appliances.
4. Connections made at the appliances should be leak checked with a bubble solution. Before placing the appliances in operation the tubing system should be purged. This displaces the air in the system with fuel gas. Be sure to bleed tubing system into a well ventilated area.

NOTE: Leak test solutions may cause corrosion to some types of material in the gas tubing system. Be sure to water rinse after the test and thoroughly dry all contacted material. Also, the vent limiter should not be leak tested with a liquid test solution. This will contaminate the internal ball check mechanism or plug the breathing hole, resulting in erratic regulator operation.

SECTION 6.1B — REGULATOR PERFORMANCE

A. Load Response

1. A performance test should be conducted while operating all appliances at full load.

This will insure adequate pressure to each appliance under full-load conditions. To accomplish this, measure the line pressure at the appliance connection while operating the appliance.

2. The inlet pressure for typical natural gas appliances should measure between 4 and 6 inches water column under full-load conditions. If this pressure can not be obtained a slight adjustment to the pounds-to-inches regulator may be necessary to increase the line pressure. Do not set any system regulator over the system design pressure (2 PSI).

B. Spring Adjustment

1. The 2 PSI system pounds-to-inches house line regulator can be adjusted with an outlet pressure ranging between 7 and 11 inches of water column. The regulator must be adjusted according to the manufacturer's recommended procedure. A pressure gauge mounted just downstream of the regulator can monitor the set pressure under various loads.
2. The regulator is typically set when the system is operating at approximately 75 percent of maximum load.
3. The average natural gas appliance is designed to operate at 3 to 4 inches water column manifold pressure, and a pressure difference of 1 to 2 inches of water column across the appliance regulator which will prevent slow regulator response. Thus, the appliance regulator will operate best at 5 to 6 inches water column inlet pressure. In this case, the 2 PSI house line regulator should be reset to deliver approximately 8 to 10 inches of water column outlet pressure under load to allow for 3 inches of water column pressure drop in the tubing. Some appliances may have different inlet pressure requirements.

CHAPTER 7

CAPACITY TABLES

SECTION 7.0 — SIZING TABLES

for **TracPipe** Flexible Gas Piping

STANDARD TABLES

Natural Gas	6-7 in. w.c. / 0.5 in. w.c. drop
	8 in. w.c. / 3 in. w.c. drop
	12-14 in. w.c. / 6 in. w.c. drop
	2 psi / 1 psi drop
	5 psi / 3.5 psi drop
Propane	11 in. w.c. / 0.5 in.w.c. drop
	2 psi / 1 psi drop
	5 psi / 3.5 psi drop

ADDITIONAL TABLES

Natural Gas	6-7 in. w.c. / 1 in. w.c. drop
	7-8 in. w.c. / 2 in. w.c. drop
	11 in. w.c. / 5 in. w.c. drop
	2 psi / 1.5 psi drop
Propane	12-14 in. w.c. / 2.5 in. w.c. drop
	2 psi / 1.5 psi drop

SECTION 7.1 — PRESSURE DROP PER FOOT TABLES

for **TracPipe** Flexible Gas Piping - Natural Gas*

*Note: For propane (LP) gas applications:

1. Convert propane BTU load to CFH propane (divide by 2520 BTU per cubic foot).
2. Multiply CFH propane (1.52 SG) value by 1.5916 to obtain equivalent CFH Natural Gas (0.6 SG) value.
3. Find pressure drop per foot using CFH Natural Gas value from Step 2. This is the pressure drop per foot for Propane at the given BTU load.
4. Follow Sum of Pressure Loss instructions.

Convert 1,000 BTU values to CFH (Propane) using the formula:

$$\text{Propane} = 2520 \text{ BTU/Cu.Ft.}$$

SECTION 7.2 — SIZING TABLE FOR STEEL PIPE

Natural Gas 0.5 PSI or less / 0.5 in. w.c. drop

SECTION 7.2A — PRESSURE DROP PER 100 FOOT OF STEEL PIPE

Table N-1 Low Pressure (Standard)

**Maximum Capacity of OmegaFlex TracPipe
in Cubic Feet per Hour Natural Gas (1,000 BTU approx)**

Gas Pressure: 6-7 in. W.C. Pressure Drop: 0.5 in. W.C. (based on a 0.6 Specific Gravity Gas)

Size (EHD)	TUBING LENGTH (FEET)																
	5	10	15	20	25	30	40	50	60	70	80	90	100	150	200	250	300
3/8"	15	44	35	31	27	25	21	19	17	16	15	14	13	10	9	8	7
1/2"	19	95	77	67	60	55	47	42	38	36	33	32	30	23	21	19	17
3/4"	25	288	206	147	132	121	105	94	86	80	75	71	67	55	48	43	39
1"	31	546	383	310	240	218	188	168	153	141	132	125	118	94	82	74	67
1-1/4"	37	1109	789	646	561	503	460	399	327	303	284	268	254	208	181	162	148
1-1/2"	46	1790	1261	1027	888	793	625	559	509	471	440	415	393	320	277	247	226
2"	62	4142	2934	2398	2078	1860	1472	1317	1203	1114	1042	983	933	762	661	591	540

see notes below*

EHD (Effective Hydraulic Diameter) A relative measure of Flow Capacity; This number is used to compare individual sizes between different manufacturers. The higher the EHD number the greater flow capacity of the piping.

Table N-2A Low Pressure (Canada & USA 1 inch drop)

**Maximum Capacity of OmegaFlex TracPipe
in Cubic Feet per Hour Natural Gas (1,000 BTU approx)**

Gas Pressure: 6-7 in. W.C. Pressure Drop: 1.0 in. W.C. (based on a 0.6 Specific Gravity Gas)

Size (EHD)	TUBING LENGTH (FEET)																	
	5	10	15	20	25	30	40	50	60	70	80	90	100	150	200	250	300	
3/8"	15	82	58	48	42	37	34	30	27	24	23	21	20	19	15	13	12	11
1/2"	19	182	131	108	94	85	78	68	61	56	52	48	46	44	36	31	28	26
3/4"	25	403	288	237	206	185	169	147	132	121	112	105	99	94	77	67	60	55
1"	31	734	518	423	366	327	299	259	231	211	195	183	172	163	133	115	103	94
1-1/4"	37	1558	1109	908	789	707	646	561	503	460	426	399	377	358	293	254	228	208
1-1/2"	46	2541	1790	1458	1261	1126	1027	888	793	723	669	625	589	559	455	393	351	320
2"	62	5848	4142	3386	2934	2626	2398	2078	1860	1698	1573	1472	1388	1317	1076	933	835	762

* NOTES: Tables above include losses for four 90-degree bends and two end fittings. Tubing runs with larger numbers of bends and/or fittings shall be increased by an equivalent length of tubing to the following equation: L=1.3n where L is additional length of tubing and n is the number of additional fittings and/or bends.

Table N-2B Low Pressure (Canada & USA 2 inch drop)

**Maximum Capacity of OmegaFlex TracPipe
in Cubic Feet per Hour Natural Gas (1,000 BTU approx)**

Gas Pressure: 7-8 in. W.C. Pressure Drop: 2 in. W.C. (based on a 0.6 Specific Gravity Gas)

Size (EHD)	TUBING LENGTH (FEET)																
	5	10	15	20	25	30	40	50	60	70	80	90	100	150	200	250	300
3/8"	115	82	67	58	52	48	42	37	34	32	30	28	27	22	19	17	15
1/2"	254	182	150	131	118	108	94	85	78	72	68	64	61	50	44	39	36
3/4"	564	403	331	288	258	237	206	185	169	157	147	139	132	108	94	84	77
1"	1038	734	599	518	463	423	366	327	299	276	259	244	231	189	163	146	133
1-1/4"	2191	1558	1277	1109	994	908	789	707	646	599	561	529	503	412	358	320	293
1-1/2"	3607	2541	2070	1790	1599	1458	1261	1126	1027	950	888	837	793	646	559	499	455
2"	8257	5848	4780	4142	3707	3386	2934	2626	2398	2221	2078	1960	1860	1520	1317	1179	1076

see notes below*

EHD (Effective Hydraulic Diameter) A relative measure of Flow Capacity; This number is used to compare individual sizes between different manufacturers. The higher the EHD number the greater flow capacity of the piping.

Table N-3 Regulator Outlet (8 inches W.C.)

**Maximum Capacity of OmegaFlex TracPipe
in Cubic Feet per Hour Natural Gas (1,000 BTU approx)**

Gas Pressure: 8 in. W.C. Pressure Drop: 3 in. W.C. (based on a 0.6 Specific Gravity Gas)

Size (EHD)	TUBING LENGTH (FEET)																
	5	10	15	20	25	30	40	50	60	70	80	90	100	150	200	250	300
3/8"	160	112	90	78	69	63	54	48	44	41	38	36	34	27	23	21	19
1/2"	327	231	189	164	147	134	116	104	95	88	82	77	73	60	52	46	42
3/4"	687	491	403	351	315	288	250	225	206	191	179	169	160	132	115	103	94
1"	1365	958	778	672	599	546	471	421	383	355	331	311	295	240	207	184	168
1-1/4"	2673	1902	1558	1353	1213	1109	963	863	789	731	685	646	614	503	436	391	358
1-1/2"	4428	3119	2541	2197	1963	1790	1548	1383	1261	1166	1090	1027	974	793	686	613	559
2"	10103	7156	5848	5069	4536	4142	3590	3213	2934	2717	2543	2398	2276	1860	1612	1442	1317

see notes below*

EHD (Effective Hydraulic Diameter) A relative measure of Flow Capacity; This number is used to compare individual sizes between different manufacturers. The higher the EHD number the greater flow capacity of the piping.

Table N-3A 3P Regulator Outlet (11 inches W.C.)

**Maximum Capacity of OmegaFlex TracPipe
in Cubic Feet per Hour Natural Gas**

Gas Pressure: 11 in. W.C. Pressure Drop: 5 in. W.C. (based on a 0.6 Specific Gravity Gas)

Size (EHD)	TUBING LENGTH (FEET)																
	5	10	15	20	25	30	40	50	60	70	80	90	100	150	200	250	300
3/8"	207	144	116	100	89	81	70	62	56	52	48	45	43	35	30	26	24
1/2"	419	297	242	210	188	172	149	133	122	113	105	99	94	77	67	60	54
3/4"	878	627	515	448	402	368	320	287	263	244	228	216	205	168	146	131	120
1"	1766	1237	1005	867	773	704	607	542	493	456	425	400	379	308	266	237	216
1-1/4"	3436	2444	2003	1739	1558	1425	1237	1109	1014	940	880	831	789	646	561	503	460
1-1/2"	5732	4038	3290	2844	2541	2317	2004	1790	1632	1510	1411	1330	1261	1027	888	793	723
2"	13026	9227	7541	6535	5858	5341	4629	4142	3783	3504	3279	3092	2934	2398	2078	1860	1698

see notes below*

EHD (Effective Hydraulic Diameter) A relative measure of Flow Capacity; This number is used to compare individual sizes between different manufacturers. The higher the EHD number the greater flow capacity of the piping.

Table N-4 Medium Pressure

**Maximum Capacity of OmegaFlex TracPipe
in Cubic Feet per Hour Natural Gas (1,000 BTU approx)**

Gas Pressure: 1/2 PSI (12-14 inches W.C.) Pressure Drop: 6 in. W.C. (based on a 0.6 Specific Gravity Gas)

Size (EHD)	TUBING LENGTH (FEET)																
	5	10	15	20	25	30	40	50	60	70	80	90	100	150	200	250	300
3/8"	229	160	130	112	99	90	78	69	63	58	54	51	48	39	34	30	27
1/2"	461	327	267	231	207	189	164	147	134	124	116	109	104	85	73	66	60
3/4"	962	687	564	491	441	403	351	315	288	267	250	237	225	185	160	144	132
1"	1946	1365	1110	958	855	778	672	599	546	505	471	444	421	342	295	263	240
1-1/4"	3757	2673	2191	1902	1704	1558	1353	1213	1109	1028	963	908	863	707	614	550	503
1-1/2"	6286	4428	3607	3119	2786	2541	2197	1963	1790	1656	1548	1458	1383	1126	974	870	793
2"	14263	10103	8257	7156	6404	5848	5069	4536	4142	3837	3590	3386	3213	2626	2276	2036	1860

* NOTES: Tables above include losses for four 90-degree bends and two end fittings. Tubing runs with larger numbers of bends and/or fittings shall be increased by an equivalent length of tubing to the following equation: L = 1.3n where L is additional length of tubing and n is the number of additional fittings and/or bends.

Table N-5 Elevated Pressure 2psi

**Maximum Capacity of OmegaFlex TracPipe
in Cubic Feet per Hour Natural Gas (1,000 BTU approx)**

Gas Pressure: 2 psi Pressure Drop: 1 psi (based on a 0.6 Specific Gravity Gas)

Size (EHD)	TUBING LENGTH (FEET)														
	10	25	30	40	50	75	80	100	150	200	250	300	400	500	
3/8"	353	220	200	172	154	124	120	107	87	75	67	61	52	46	3/8"
1/2"	700	444	405	351	314	257	249	222	182	157	141	129	111	100	1/2"
3/4"	1444	926	847	737	661	543	527	473	388	338	303	277	241	216	3/4"
1"	2986	1869	1703	1470	1311	1066	1031	920	748	645	576	525	453	404	1"
1-1/4"	5670	3615	3305	2870	2572	2108	2042	1830	1499	1302	1167	1067	926	830	1-1/4"
1-1/2"	9599	6041	5509	4763	4255	3467	3355	2997	2442	2111	1886	1720	1487	1329	1-1/2"
2"	21637	13715	12526	10855	9715	7940	7689	6881	5624	4874	4362	3983	3452	3089	2"

* NOTES: Table does not include effect of pressure drop across the line regulator. If regulator loss exceeds 3/4 PSI (based on 8 inch outlet pressure) Do not use this chart. Pressure drops across a regulator vary with flow rate. FGP-REG-3 has a 3/4 PSI pressure drop at a flow of 250 cubic feet per hour. CAUTION: Capacities shown in table may exceed maximum capacity for a selected regulator. EHD (Effective Hydraulic Diameter) A relative measure of Flow Capacity; This number is used to compare individual sizes between different manufacturers. The higher the EHD number the greater flow capacity of the piping.

Table N-5A Elevated Pressure 2psi

**Maximum Capacity of OmegaFlex TracPipe
in Cubic Feet per Hour Natural Gas (1,000 BTU approx)**

Gas Pressure: 2 psi Pressure Drop: 1.5 psi (based on a 0.6 Specific Gravity Gas)

Size (EHD)	TUBING LENGTH (FEET)														
	10	25	30	40	50	75	80	100	150	200	250	300	400	500	
3/8"	438	271	247	212	189	153	148	131	106	91	81	74	64	56	3/8"
1/2"	855	542	495	429	384	314	304	272	222	193	172	157	136	122	1/2"
3/4"	1761	1129	1033	899	806	662	642	576	473	411	369	338	294	264	3/4"
1"	3687	2304	2098	1810	1614	1311	1268	1131	919	793	707	644	555	495	1"
1-1/4"	6919	4412	4034	3502	3139	2572	2492	2233	1830	1589	1424	1302	1130	1013	1-1/4"
1-1/2"	11782	7415	6762	5847	5223	4255	4119	3679	2997	2592	2315	2111	1826	1631	1-1/2"
2"	26473	16781	15326	13282	11886	9715	9408	8419	6881	5963	5337	4874	4224	3780	2"

Table N-6 Elevated Pressure 5psi

**Maximum Capacity of OmegaFlex TracPipe
in Cubic Feet per Hour Natural Gas (1,000 BTU approx)**

Gas Pressure: 5 psi

Pressure Drop: 3.5 psi (based on a 0.6 Specific Gravity Gas)

Size (EHD)	TUBING LENGTH (FEET)													
	10	25	30	40	50	75	80	100	150	200	250	300	400	500
3/8"	672	420	382	329	293	238	230	205	166	143	128	116	100	89
1/2"	1304	827	755	654	586	479	463	415	339	294	263	240	208	186
3/4"	2650	1699	1556	1353	1214	998	967	868	713	620	556	509	443	397
1"	5659	3543	3228	2786	2486	2021	1955	1744	1418	1224	1092	955	858	766
1-1/4"	10489	6688	6116	5310	4759	3899	3778	3386	2774	2409	2159	1974	1714	1536
1-1/2"	18080	11378	10377	8972	8015	6530	6320	5646	4600	3977	3553	3240	2802	2503
2"	40353	25580	23361	20246	18119	14809	14341	12834	10489	9090	8135	7430	6439	5762

* NOTES: Table does not include effect of pressure drop across the line regulator. If regulator loss exceeds 3/4 PSI (based on 8 inch outlet pressure) Do not use this chart. Pressure drops across a regulator vary with flow rate. FGP-REG-5 has a 1 PSI pressure drop at a flow of 673 cubic feet per hour. CAUTION: Capacities shown in table may exceed maximum capacity for a selected regulator.

Table P-1 Propane Low Pressure (Standard)

**Maximum Capacity of OmegaFlex TracPipe™
in Thousands of BTU per Hour Propane Gas**

Gas Pressure: 11 in. W.C.

Pressure Drop: 0.5 in. W.C. (based on a 1.52 Specific Gravity Gas)

Size (EHD)	TUBING LENGTH (FEET)																
	5	10	15	20	25	30	40	50	60	70	80	90	100	150	200	250	300
3/8"	99	69	55	49	42	39	33	30	26	25	23	22	20	15	14	12	11
1/2"	211	150	121	106	94	87	74	66	60	57	52	50	47	36	33	30	26
3/4"	456	325	267	232	209	191	166	149	136	126	118	112	106	87	76	68	62
1"	863	605	490	425	379	344	297	265	241	222	208	197	186	143	129	117	107
1-1/4"	1753	1247	1021	887	795	727	631	566	517	479	449	424	402	329	286	256	234
1-1/2"	2830	1993	1623	1404	1254	1143	988	884	805	745	696	656	621	506	438	390	357
2"	6547	4638	3791	3285	2940	2684	2327	2082	1902	1761	1647	1554	1475	1205	1045	934	854

see notes below*

EHD (Effective Hydraulic Diameter) A relative measure of Flow Capacity; This number is used to compare individual sizes between different manufacturers. The higher the EHD number the greater flow capacity of the piping.

Table P-2 Propane Medium Pressure

**Maximum Capacity of OmegaFlex TracPipe
in Thousands of BTU per Hour Propane Gas**

Gas Pressure: 1/2 psi (12-14 in. W. C.) Pressure Drop: 2.5 in. W. C. (based on a 1.52 Specific Gravity Gas)

Size (EHD)	TUBING LENGTH (FEET)																
	5	10	15	20	25	30	40	50	60	70	80	90	100	150	200	250	300
3/8"	222	159	131	114	102	93	81	73	67	62	58	55	52	43	37	33	30
1/2"	491	353	290	254	228	209	182	164	150	140	131	124	118	97	85	76	70
3/4"	1094	782	642	559	501	459	399	358	328	304	285	269	256	210	183	164	136
1"	2512	1863	1720	1343	1106	976	883	825	771	719	673	632	596	470	398	352	320
1-1/4"	3863	2749	2253	1955	1753	1603	1391	1247	1140	1056	990	934	887	727	631	566	517
1-1/2"	6383	4496	3663	3168	2830	2580	2230	1993	1818	1682	1571	1481	1404	1143	988	884	805
2"	14586	10330	8443	7317	6547	5980	5183	4638	4236	3923	3671	3462	3285	2684	2327	2082	1902

NOTES: Tables above include losses for four 90-degree bends and two end fittings. Tubing runs with larger numbers of bends and/or fittings shall be increased by an equivalent length of tubing to the following equation: L=1.3n where L is additional length of tubing and n is the number of additional fittings and/or bends.

Table P-3 Propane Elevated Pressure 2psi

**Maximum Capacity of OmegaFlex TracPipe™
in Thousands of BTU per Hour Propane Gas**

Gas Pressure: 2 psi Pressure Drop: 1 psi (based on a 1.52 Specific Gravity Gas)

Size (EHD)	TUBING LENGTH (FEET)														
	10	25	30	40	50	75	80	100	150	200	250	300	400	500	
3/8"	558	347	316	271	243	196	189	169	137	118	105	96	82	72	
1/2"	1106	701	640	554	496	406	393	350	287	248	222	203	175	158	
3/4"	2282	1464	1340	1165	1046	859	833	748	614	534	479	439	381	342	
1"	4720	2954	2692	2323	2072	1685	1629	1454	1182	1019	910	829	716	638	
1-1/4"	8963	5714	5224	4537	4066	3332	3228	2893	2370	2058	1845	1687	1464	1312	
1-1/2"	15174	9549	8708	7529	6726	5480	5303	4738	3860	3337	2981	2719	2351	2101	
2"	34203	21680	19801	17159	15357	12551	12154	10877	8890	7705	6895	6296	5457	4883	

* NOTES: Table does not include effect of pressure drop across the line regulator. If regulator loss exceeds 3/4 PSI (based on 8 inch outlet pressure) Do not use this chart. Pressure drops across a regulator vary with flow rate. FGP-REG-3P has a 3/4 PSI pressure drop at a flow of 161 cubic feet per hour. CAUTION: Capacities shown in table may exceed maximum capacity for a selected regulator. EHD (Effective Hydraulic Diameter) A relative measure of Flow Capacity; This number is used to compare individual sizes between different manufacturers. The higher the EHD number the greater flow capacity of the piping.

Table P-3A Propane Elevated Pressure 2 psi

**Maximum Capacity of OmegaFlex TracPipe™
in Thousands of BTU per Hour Propane Gas**

Gas Pressure: 2 psi

Pressure Drop: 1.52 psi (based on a 1.52 Specific Gravity Gas)

Size (EHD)	TUBING LENGTH (FEET)														
	10	25	30	40	50	75	80	100	150	200	250	300	400	500	
3/8"	817	525	481	419	376	310	300	269	222	193	173	159	138	124	3/8"
1/2"	1588	1041	957	839	757	628	609	550	456	399	360	331	290	262	1/2"
3/4"	3237	2147	1978	1739	1574	1312	1275	1153	962	845	765	705	619	560	3/4"
1"	6838	4436	4070	3553	3198	2641	2561	2305	1903	1661	1495	1372	1198	1078	1"
1-1/4"	10937	6974	6377	5536	4962	4066	3939	3530	2893	2512	2251	2058	1786	1601	1-1/4"
1-1/2"	18624	11721	10689	9243	8256	6726	6511	5816	4738	4097	3659	3337	2886	2578	1-1/2"
2"	41847	26527	24227	20996	18789	15357	14872	13308	10877	9426	8436	7705	6677	5975	2"

Table P-4 Propane Elevated Pressure 5psi

**Maximum Capacity of OmegaFlex TracPipe™
in Thousands of BTU per Hour Propane Gas**

Gas Pressure: 5 psi

Pressure Drop: 3.5 psi (based on a 1.52 Specific Gravity Gas)

Size (EHD)	TUBING LENGTH (FEET)														
	10	25	30	40	50	75	80	100	150	200	250	300	400	500	
3/8"	1065	664	603	520	463	376	363	324	262	226	202	183	158	140	3/8"
1/2"	2061	1307	1193	1033	926	757	731	656	535	464	416	379	328	294	1/2"
3/4"	4189	2686	2459	2139	1920	1577	1529	1310	1127	980	880	805	700	629	3/4"
1"	8945	5600	5102	4404	3929	3194	3090	2756	2241	1934	1726	1572	1356	1210	1"
1-1/4"	16581	10572	9668	8394	7523	6163	5972	5352	4796	4385	3808	3120	2709	2428	1-1/4"
1-1/2"	28580	17986	16403	14183	12670	10322	9990	8925	7271	6287	5616	5122	4429	3957	1-1/2"
2"	63788	40436	36928	32004	28642	23409	22670	20287	16581	14369	12859	11745	10178	9108	2"

* NOTES: Table does not include effect of pressure drop across the line regulator. If regulator loss exceeds 3/4 PSI (based on 8 inch outlet pressure) Do not use this chart. Pressure drops across a regulator vary with flow rate. Maxitrol FGP-REG-5 has a 1 PSI pressure drop at a flow of 434 cubic feet per hour. CAUTION: Capacities shown in table may exceed maximum capacity for a selected regulator.

Section 7.1 — Table PD-1

Pressure Drop per foot for **TracPipe** (Natural Gas) (For Propane See Below)

3/8" CSST		1/2" CSST		3/4" CSST		1" CSST	
CFH	"W.C.	CFH	"W.C.	CFH	"W.C.	CFH	"W.C.
20	0.011	20	0.002	30	0.001	50	0.001
30	0.025	30	0.004	40	0.002	60	0.001
40	0.045	40	0.008	50	0.003	70	0.002
50	0.071	50	0.013	60	0.004	80	0.002
60	0.104	60	0.019	70	0.005	90	0.003
70	0.143	70	0.027	80	0.007	100	0.004
80	0.188	80	0.035	90	0.009	110	0.005
90	0.240	90	0.045	100	0.011	120	0.005
100	0.299	100	0.056	110	0.014	130	0.006
110	0.364	110	0.069	120	0.016	140	0.007
120	0.436	120	0.082	130	0.019	150	0.008
130	0.515	130	0.098	140	0.022	160	0.010
140	0.600	140	0.114	150	0.026	170	0.011
150	0.693	150	0.132	160	0.030	180	0.012
160	0.792	160	0.151	170	0.034	190	0.013
170	0.897	170	0.172	180	0.038	200	0.015
180	1.010	180	0.194	190	0.042	210	0.016
190	1.130	190	0.217	200	0.047	220	0.018
200	1.257	200	0.242	210	0.052	230	0.020
210	1.390	210	0.268	220	0.057	240	0.021
220	1.531	220	0.295	230	0.063	250	0.023
230	1.678	230	0.324	240	0.068	260	0.025
240	1.833	240	0.355	250	0.074	270	0.027
250	1.995	250	0.387	260	0.081	280	0.029
260	2.163	260	0.420	270	0.087	290	0.031
270	2.339	270	0.455	280	0.094	300	0.034
280	2.522	280	0.491	290	0.101	310	0.036
290	2.712	290	0.529	300	0.108	320	0.038
300	2.910	300	0.568	310	0.116	330	0.041
310	3.114	310	0.608	320	0.124	340	0.043
320	3.326	320	0.650	330	0.132	350	0.046
330	3.544	330	0.694	340	0.140	360	0.048
340	3.770	340	0.739	350	0.149	370	0.051
350	4.004	350	0.785	360	0.158	380	0.054
360	4.244	360	0.833	370	0.167	390	0.057
370	4.492	370	0.883	380	0.176	400	0.060
380	4.747	380	0.934	390	0.186	410	0.063
390	5.009	390	0.986	400	0.196	420	0.066
400	5.279	400	1.040	410	0.206	430	0.069
410	5.556	410	1.096	420	0.217	440	0.072
420	5.840	420	1.153	430	0.228	450	0.075
430	6.132	430	1.211	440	0.239	460	0.079
440	6.431	440	1.271	450	0.250	470	0.082
450	6.737	450	1.333	460	0.262	480	0.086
460	7.051	460	1.396	470	0.274	490	0.089
470	7.372	470	1.461	480	0.286	500	0.093
480	7.701	480	1.527	490	0.298	510	0.097
490	8.037	490	1.595	500	0.311	520	0.100
500	8.380	500	1.664	510	0.324	530	0.104

* NOTE: For Propane (LP) Gas applications, obtain Pressure drop per foot values for Propane by following the Propane conversion method detailed in Section 7.1.

Table PD-1
Pressure Drop per foot for *TracPipe* (Natural Gas) (For Propane See Below)

1 1/4" CSST		1 1/2" CSST		2" CSST	
CFH	"W.C.	CFH	"W.C.	CFH	"W.C.
80	0.0005	210	0.001	510	0.001
90	0.001	220	0.002	520	0.002
100	0.001	230	0.002	530	0.002
110	0.001	240	0.002	540	0.002
120	0.001	250	0.002	560	0.002
130	0.001	260	0.002	570	0.002
140	0.001	270	0.002	580	0.002
150	0.002	280	0.003	590	0.002
160	0.002	290	0.003	600	0.002
170	0.002	300	0.003	610	0.002
180	0.002	310	0.003	620	0.002
190	0.003	320	0.003	630	0.002
200	0.003	330	0.004	640	0.002
210	0.003	340	0.004	650	0.002
220	0.004	350	0.004	660	0.002
230	0.004	360	0.004	670	0.003
240	0.004	370	0.004	680	0.003
250	0.005	380	0.005	690	0.003
260	0.005	390	0.005	700	0.003
270	0.006	400	0.005	710	0.003
280	0.006	410	0.005	720	0.003
290	0.007	420	0.006	730	0.003
300	0.007	430	0.006	740	0.003
310	0.007	440	0.006	750	0.003
320	0.008	450	0.007	760	0.003
330	0.008	460	0.007	770	0.003
340	0.009	470	0.007	780	0.003
350	0.010	480	0.007	790	0.004
360	0.010	490	0.008	800	0.004
370	0.011	500	0.008	810	0.004
380	0.011	510	0.008	820	0.004
390	0.012	520	0.009	830	0.004
400	0.013	530	0.009	840	0.004
410	0.013	540	0.009	850	0.004
420	0.014	560	0.010	860	0.004
430	0.015	570	0.010	870	0.004
440	0.015	580	0.011	880	0.004
450	0.016	590	0.011	890	0.005
460	0.017	600	0.011	900	0.005
470	0.017	610	0.012	910	0.005
480	0.018	620	0.012	920	0.005
490	0.019	630	0.013	930	0.005
500	0.020	640	0.013	940	0.005
510	0.021	650	0.013	950	0.005
520	0.021	660	0.014	960	0.005
530	0.022	670	0.014	970	0.005
540	0.023	680	0.015	980	0.006
550	0.024	690	0.015	990	0.006
560	0.025	700	0.016	1000	0.006

* NOTE: For Propane (LP) Gas applications, obtain Pressure drop per foot values for Propane by following the Propane conversion method detailed in Section 7.1.

Pressure Drop per foot for *TracPipe* (Natural Gas) (For Propane See Below)

1/2" CSST		3/4" CSST		1" CSST	
CFH	"W.C.	CFH	"W.C.	CFH	"W.C.
510	1.735	520	0.337	540	0.108
520	1.807	530	0.351	560	0.117
530	1.881	540	0.364	570	0.121
540	1.957	560	0.393	580	0.125
560	2.113	570	0.407	590	0.129
570	2.193	580	0.422	600	0.134
580	2.275	590	0.437	610	0.138
590	2.358	600	0.453	620	0.143
600	2.443	610	0.469	630	0.147
610	2.529	620	0.485	640	0.152
620	2.618	630	0.501	650	0.157
630	2.707	640	0.517	660	0.162
640	2.798	650	0.534	670	0.167
650	2.891	660	0.551	680	0.172
660	2.986	670	0.569	690	0.177
670	3.082	680	0.586	700	0.182
680	3.180	690	0.604	710	0.187
690	3.279	700	0.622	720	0.192
700	3.380	710	0.641	730	0.198
710	3.482	720	0.660	740	0.203
720	3.586	730	0.679	750	0.209
730	3.692	740	0.698	760	0.214
740	3.799	750	0.718	770	0.220
750	3.908	760	0.738	780	0.226
760	4.019	770	0.758	790	0.232
780	4.244	780	0.778	800	0.237
790	4.360	790	0.799	810	0.243
800	4.477	800	0.820	820	0.249
810	4.596	810	0.841	830	0.256
		820	0.863	840	0.262
		830	0.885	850	0.268
		840	0.907	860	0.274
		850	0.929	870	0.281
		860	0.952	880	0.287
		870	0.975	890	0.294
		880	0.998	900	0.300
		890	1.022	910	0.307
		900	1.045	920	0.314
		910	1.070	930	0.321
		920	1.094	940	0.328
		930	1.119	950	0.335
		940	1.144	960	0.342
		950	1.169	970	0.349
		960	1.194	980	0.356
		970	1.220	990	0.363
		980	1.246	1000	0.371
		990	1.273	1010	0.378
		1000	1.299	1020	0.386
		1010	1.326	1030	0.393

* NOTE: For Propane (LP) Gas applications, obtain Pressure drop per foot values for Propane by following the Propane conversion method detailed in Section 7.1.

Pressure Drop per foot for *TracPipe* (Natural Gas) (For Propane See Below)

1 1/4" CSST		1 1/2" CSST		2" CSST	
CFH	"W.C.	CFH	"W.C.	CFH	"W.C.
570	0.026	710	0.016	1010	0.006
580	0.027	720	0.016	1020	0.006
590	0.028	730	0.017	1030	0.006
600	0.029	740	0.017	1040	0.006
610	0.030	750	0.018	1050	0.006
620	0.031	760	0.018	1060	0.006
630	0.032	770	0.019	1070	0.007
640	0.033	780	0.019	1080	0.007
650	0.034	790	0.020	1090	0.007
660	0.035	800	0.020	1100	0.007
670	0.036	810	0.021	1200	0.008
680	0.037	820	0.021	1300	0.010
690	0.038	830	0.022	1400	0.011
700	0.039	840	0.022	1500	0.013
710	0.040	850	0.023	1600	0.015
720	0.041	860	0.023	1700	0.017
730	0.043	870	0.024	1800	0.019
740	0.044	880	0.025	1900	0.021
750	0.045	890	0.025	2000	0.023
760	0.046	900	0.026	3000	0.052
770	0.048	910	0.026	4000	0.093
780	0.049	920	0.027	5000	0.146
790	0.050	930	0.027	6000	0.210
800	0.051	940	0.028	7000	0.287
810	0.053	950	0.029	8000	0.375
820	0.054	960	0.029	9000	0.476
830	0.055	970	0.030	10000	0.588
840	0.057	980	0.030	11000	0.712
850	0.058	990	0.031	12000	0.848
860	0.060	1000	0.032	13000	0.996
870	0.061	1010	0.032	14000	1.156
880	0.062	1020	0.033	15000	1.328
890	0.064	1030	0.033	16000	1.512
900	0.065	1040	0.034	17000	1.708
910	0.067	1050	0.035	18000	1.915
920	0.068	1060	0.035	19000	2.135
930	0.070	1070	0.036	20000	2.367
940	0.071	1080	0.037	21000	2.611
950	0.073	1090	0.037	22000	2.867
960	0.075	1100	0.038	25000	3.707
970	0.076	1200	0.045	28000	4.655
980	0.078	1300	0.053	30000	5.348
990	0.079	1400	0.061	32000	6.089
1000	0.081	1500	0.070	35000	7.290
1010	0.083	1600	0.080	38000	8.601
1020	0.084	1700	0.090	40000	9.535
1030	0.086	1800	0.101	42000	10.517
1040	0.088	1900	0.112		
1050	0.089	2000	0.124		

* NOTE: For Propane (LP) Gas applications, obtain Pressure drop per foot values for Propane by following the Propane conversion method detailed in Section 7.1.

SECTION 7.2

Table SP-1
 Maximum Capacity of Pipe in Cubic Feet of Gas per Hour for Gas Pressures
 of 0.5 psi or Less and a Pressure Drop of 0.5 Inch Water Column (Based on a 0.6 Specific Gravity)

Normal Iron Pipe Size (Inches)	Internal Diameter (inches)	Length of Pipe (Feet)															
		10	20	30	40	50	60	70	80	90	100	125	150	175	200		
1/4	.364	43	29	24	20	18	16	15	14	13	12	11	10	9	8		
3/8	.493	95	65	52	45	40	36	33	31	29	27	24	22	20	19		
1/2	.622	175	120	97	82	73	66	61	57	53	50	44	40	37	35		
3/4	.824	360	250	200	170	151	138	125	118	110	103	93	84	77	72		
1	1.049	680	465	375	320	285	260	240	220	205	195	175	160	145	135		
1 1/4	1.380	1,400	950	770	660	580	530	490	460	430	400	360	325	300	280		
1 1/2	1.610	2,100	1,460	1,180	990	900	810	750	690	650	620	550	500	460	430		
2	2.067	3,950	2,750	2,200	1,900	1,680	1,520	1,400	1,300	1,220	1,150	1,020	950	850	800		
2 1/2	2.469	6,300	4,350	3,520	3,000	2,650	2,400	2,250	2,050	1,950	1,850	1,650	1,500	1,370	1,280		
3	3.068	11,000	7,700	6,250	5,300	4,750	4,300	3,900	3,700	3,450	3,250	2,950	2,650	2,450	2,280		
4	4.026	23,000	15,800	12,800	10,900	9,700	8,800	8,100	7,500	7,200	6,700	6,000	5,500	5,000	4,600		

SECTION 7.2A

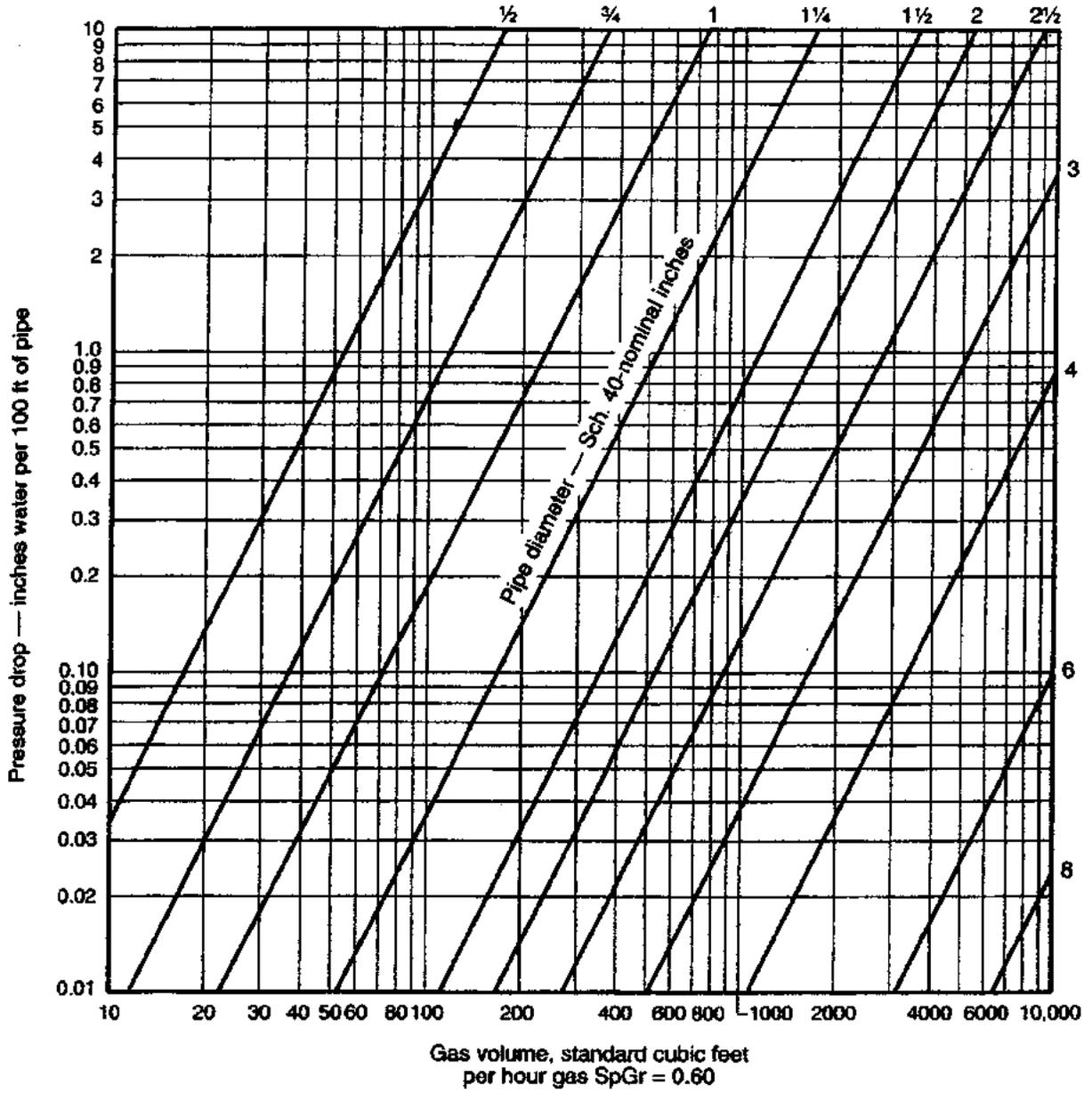

* Reprinted from The National Fuel Gas Code Handbook, 1996 Edition

CHAPTER 8

DEFINITION OF TERMINOLOGY

A.G.A. – American Gas Association

ANSI Z223.1 1988 – 1988 edition of the National Fuel Gas Code published by American National Standard Institute. Also known as NFPA 54 (National Fire Protection Association).

Appliance (Equipment) – Any device which utilizes natural gas or propane as a fuel or raw material to produce light, heat, power, refrigeration or air conditioning.

Approved – Acceptable to the authorities having jurisdiction.

Authority Having Jurisdiction – The organization, office or individual responsible for “approving” equipment, an installation or a procedure.

Btu – Abbreviation for British Thermal Unit, which is the quantity of heat required to raise the temperature of one pound of water one degree Fahrenheit .

Cfh – Gas flow rate stated in cubic feet per hour.

Clothes Dryer – A device used to dry wet laundry by means of heat derived from the combustion of natural gases.

Design Pressure – The maximum operating pressure permitted by this document, as determined by the design procedures applicable to the materials involved.

Drip Leg – The container (dirt trap pocket) placed at a low point in a system of piping to collect foreign material or condensate and from which it may be removed.

EHD (Effective Hydraulic Diameter) – A relative measure of Flow Capacity; This number is used to compare individual sizes between different manufacturers. The higher the EHD number the greater flow capacity of the piping.

Full Lockup – The capability of totally stopping the flow of gas if the load goes to zero, thus preventing the downstream pressure from increasing

more than a certain upper limit pressure above the set point.

Header (manifold) – A pipe or fitting to which a number of branch lines are connected.

ID – Inside diameter of pipe or tubing.

Inches (") W.C. – Method of stating pressure measured in inches of water column by a manometer or pressure gauge. Commonly used in the gas industry when the pressure is less than one (1) PSI.

1 PSI = 28 in. W.C. approximately

1/2 PSI = 14 in. W.C.

1/4 PSI = 7 in. W.C.

Load – The amount of gas in Cfh required by an appliance, or group of appliances, per their rating plate.

L. P. Gas – Fuel gas that is stored and transported in a liquid state, i.e., propane, butane, and mixtures of these and other heavier hydrocarbons.

Meter – An instrument installed to measure the volume of gas delivered through a piping system.

Manometer – A “U” shaped tube filled with water, or mercury where the pressure applied to one leg of the “U” will push the liquid column a measurable distance. Also known as a “U” gauge.

OD – Outside Diameter of pipe or tubing.

1/2 PSI – A shortened way of stating 1/2 pounds per square inch gauge. Also the name of a low pressure piping system supplying gas from the meter at 1/2 PSI to each appliance pressure regulator.

Piping – As used in this document, either pipe or tubing, or both.

a. pipe – Rigid conduit of iron, steel, copper, brass or aluminum.

b. tubing – Semi rigid conduit of corrugated stainless steel.

Pressure – Unless otherwise stated, is expressed in pounds per square inch above atmospheric pressure, i.e. gage pressure (PSI).

Pressure Drop – The loss in static pressure of gas due to friction or obstruction in tubing, valves, fittings, regulators and burners.

Pressure Regulator – A valve which reduces and controls pressure. It automatically opens and closes in response to changing pressure conditions in the downstream piping.

PSI – Pounds per square inch gauge. The pressure, as read from a measurement gage or device. Gauge pressure is pressure above atmospheric pressure.

Purge – To displace the original air, or gas, or a mixture of gas and air in a gas conduit with a new air/gas mixture.

Regulator, Appliance (inches w.c. – inches w.c.) – A device for controlling and maintaining a uniform pressure to the manifold of gas burning equipment. This valve is typically part of the appliance. It reduces the pressure from 5.5" w.c. to the manifold pressure in the appliance. (approximately 3.5" w.c.).

Regulator, House Line (PSI – inches w.c.) – A device placed in a gas line between the service regulator and the appliance regulator for controlling, maintaining or reducing the pressure in that portion of the piping system downstream of the device. This valve reduces the house line pressure (Typically 2 PSI) to the regulator manifold pressure (Typically 8-10" w.c.).

Regulator, Service (PSI – PSI or inches w.c.) – A device installed by the serving gas supplier to reduce and limit the service line gas pressure. This valve reduces the service pressure to the metering pressure. It is located upstream of the gas meter.

Regulator Vent – The opening in the atmospheric side of the regulator housing permitting the in and out movement of air to compensate for the movement of the regulator diaphragm.

Specific Gravity – As applied to gas, the ratio of the weight of a given volume to that of the same volume of air, both measured under the same conditions.

2 PSI – A shortened way of stating 2 pounds per square inch gauge pressure. Also the name of a piping system supplying gas at 2 PSI to a house line regulator which then reduces the pressure to inches W.C. upstream of the appliance regulator.

Valve, Manual Shut-off – A valve (located in the piping system and readily accessible and operable by the consumer) used to shut off individual equipment.

Vent Limiter Device – Restriction/orifice type device in the vent outlet of a pressure regulator that controls or limits leakage, in the event of a diaphragm leak. It also allows the diaphragm to move freely to control pressure.

APPENDIX A UL CLASSIFICATION

The UL Through Penetration Firestop Systems in Appendix A are only a sample of the complete UL database. See NOTE on Page 90.

System No. W-J-1106

F-Rating - 1 & 2 Hr
T-Rating - 3/4 and 1-1/4 Hr

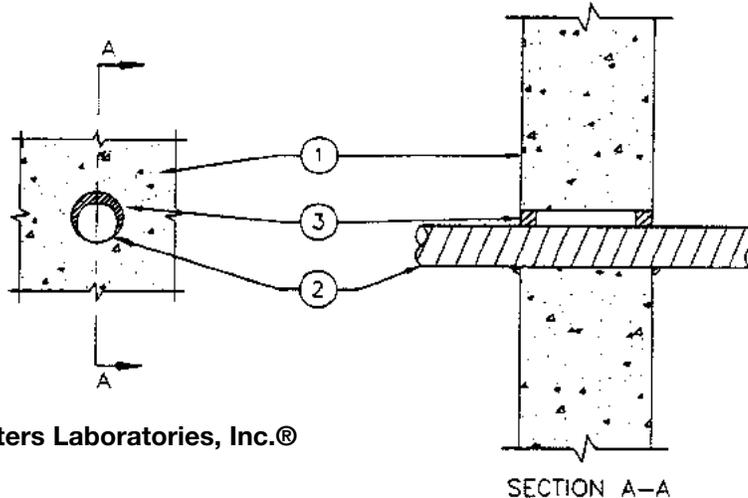

- 1. Wall Assembly-** Min 4-7/8 in. or 6-1/8 in. thick lightweight or normal weight (100-150 pcf) concrete for 1 or 2 hr rated assemblies, respectively. Wall may also be constructed of any UL Classified **Concrete Blocks***. Max diam of opening is 3-1/2 in.
See **Concrete Blocks** (CAZT) category in the Fire Resistance Directory for names of manufacturers.
- 2. Through Penetrating Products*-Flexible Metal Piping-**Nom. 2 in. diam (or smaller) steel flexible metallic piping. Max one flexible metal piping to be installed either concentrically or eccentrically within opening. The annular space between piping and periphery of opening shall be min 0 (point contact) in. to max 1 in. Piping to be rigidly supported on both sides of wall assembly. Plastic covering on piping may or may not be removed on both sides of wall assembly.
Omegaflex Inc.—TracPipe Flexible Gas Piping.
- 3. Fill, Void, or Cavity Material*-Sealant** -Min. 5/8 and 1 in. thickness of fill material for 1 and 2 hr fire-rated wall assemblies, respectively, applied within the annulus, flush with both surfaces of wall. An additional 1/2 in. diam of fill material applied at gypsum board/penetrant interface at point contact location on both surfaces of wall.
Johns Manville International, Inc. — Firetemp™ CI

*Bearing the UL Classification Marking

SYSTEM No. C-AJ-1340

Floor or Wall Assembly-Min 4-1/2 in. thick lightweight or normal weight (100 to 150 pcf) concrete. Wall may also be constructed of any UL Classified **Concrete Blocks***. Diam of opening in floor or wall assembly to be min 3/4 in. to max 1-1/2 in. Larger than diam of flexible metal piping (Item 2) installed in through opening. Max diam of opening is 4 in. See Concrete Block (CAZT) category in the Fire Resistance Directory for names of manufacturers.

Through-Penetrant*-Omegaflex Gas Piping-Nom 2 in. diam (or smaller) flexible gas piping. One flexible gas piping to be installed either concentrically or eccentrically within the firestop system. The annular space between gas piping and periphery of opening shall be min 0 in. (point contact) to max. 1-1/2 in. Gas piping to be rigidly supported on both sides of floor or wall assembly. Plastic covering on piping may or may not be removed on both sides of floor or wall assembly. **OmegaFlex, Inc.-TracPipe Flexible Gas Piping**

Firestop System The firestop system shall consist of the following:

A. Packing Material-Min 3-3/4 in. thickness of min 4 pcf mineral wool batt insulation firmly packed into opening as a permanent form. Packing material to be recessed from top surface of floor or from both surfaces wall as required to accommodate the required thickness of fill material.

B. Fill, Void or Cavity Material* -Sealant Min 3/4 in. thickness of fill material applied within the annulus, flush with top surface of floor or both surfaces of wall. Min 1/2 in. diam bead of caulk applied to the penetrant/concrete or penetrant/concrete interface at the point contact location between penetrant and periphery of opening.

Passive Fire Protection Partners--4800DW

* Bearing the UL Classification Marking

XHEZ
Through Penetration Firestop systems

System No. C-AJ-1340
F-Rating - 4 Hr
T-Rating - 2 1/4 Hr

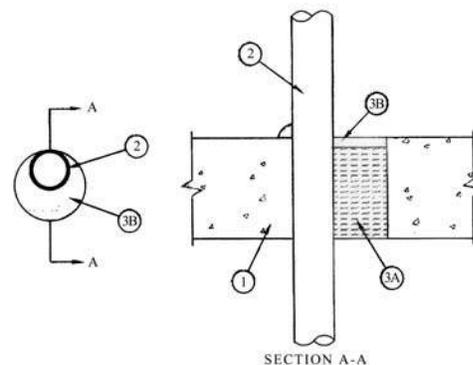

UL CLASSIFICATION

SYSTEM NO. W-L-1195

The UL Through Penetration Firestop Systems in Appendix A are only a sample of the complete UL database. See NOTE below.

1. Wall Assembly- The 1 or 2 hr fire rated gypsum wallboard/stud wall assembly shall be constructed of the materials and in the manner described in the individual U300 or U400 Series Wall and Partition Designs in the UL Fire Resistance Directory and shall include the following construction features:

A. Studs- Wall framing may consist of either wood studs or steel channel studs. Wood studs to consist of nom 2 by 4 in. lumber spaced 16 in. OC with nom 2 by 4 in. Lumber end plates and cross braces. Steel studs to be min 3-5/8 in. wide by 1-3/8 in. deep channels spaced max 24 in. OC.

B. Wallboard, Gypsum*- Thickness, type, number of layers and fasteners as required in the individual Wall and Partition Design. Max diam of opening is 3-1/2 in.

XXEZ
Through-Penetration Firestop Systems
System No. W-L-1195
F Rating - 1 & 2 hr (See Item 1)
T Rating - 3/4 & 1-1/4 hr(See Item 1)

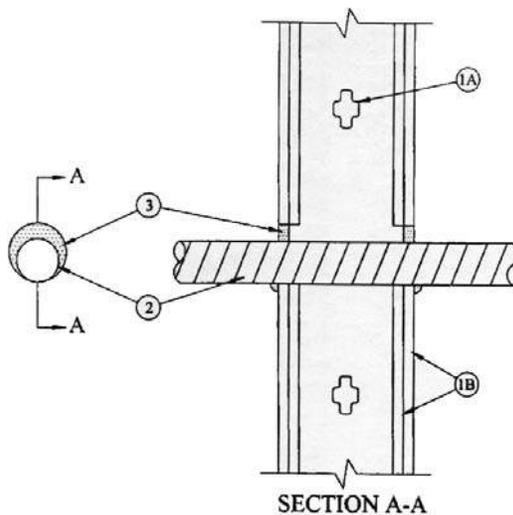

Underwriters Laboratories inc.®

1. The hourly F rating of the firestop system is equal to the hourly fire rating of the wall assembly in which it is installed. The hourly T rating is 3/4 hr and 1-1/4 hr for 1 and 2 hr rated assemblies, respectively.

2. Through-Penetrating Product*-Flexible Metal Piping-Nom 2 in. diam (or smaller) steel Flexible Metal Piping. Max one flexible metal piping to be installed either concentrically or eccentrically within opening. The annular space between pipe and periphery of opening shall be min 0 in. (point contact)to max 1 in. Piping to be rigidly supported on both sides of wall assembly. Plastic covering on piping may or may not be removed for a distance of 2 ft. on both sides of wall assembly. **OmegaFlex, Inc.- TracPipe Flexible Gas Piping**

3. Fill, Void, or Cavity Material*-Sealant - Min 5/8 and 1 in. thickness of fill material for 1 and 2 hr fire-rated wall assemblies, respectively, applied within the annulus, flush with both surfaces of wall. An additional 1/2 in diameter of fill material applied at gypsum board/penetrant interface at point contact location on both surfaces of wall.

Johns Manville International, Inc - Firetemp™CI

*Bearing the UL Classification Marking

NOTE: to access the complete UL Through Penetration Firestop Systems database online:

1. Go to website www.ul.com
2. Click on : "CERTIFICATIONS" in left hand panel
3. Click on : "Company name/location" under General Search
4. Fill in OmegaFlex inc (3 words) in "Company Name" box
5. All approved systems are shown

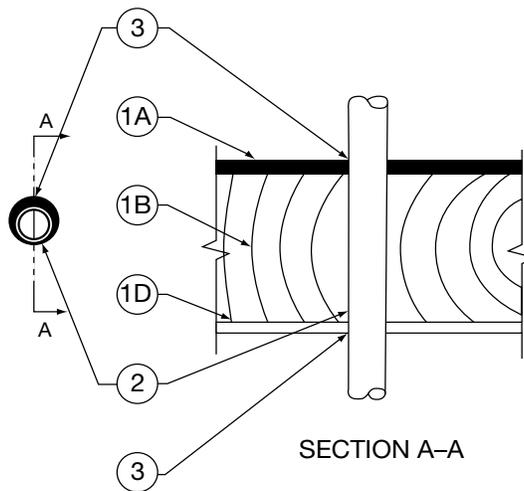

1. **Floor Assembly** - The 1 or 2 hr fire-rated wood joist, wood truss or combination wood and steel truss Floor-Ceiling assembly shall be constructed of the materials and in the manner described in the individual L500 Series Design in the UL Fire Resistance Directory. **The F Rating of the firestop system is equal to the rating of the floor-ceiling and wall assemblies.** The general construction features of the floor-ceiling assembly are summarized below:
 - A. **Flooring System** - Lumber or plywood subfloor with finish floor of lumber, plywood or **Floor Topping Mixture*** as specified in the individual Floor-Ceiling Design. Max diam of opening is 3 in. (76 mm).
 - B. **Joists** - Nom 2 by 10 in. (51 by 254 mm) deep (or deeper) lumber joists spaced 16 in. (406 mm) OC or steel or combination lumber and steel joists, trusses or **Structural Wood Members*** with bridging as required and with ends firestopped.
 - C. **Furring Channels (Not Shown)** (As required) Resilient galvanized steel furring installed in accordance with the manner specified in the individual L500 Series Designs in the Fire Resistance Directory.
 - D. **Gypsum Board*** - Thickness, type, number of layers and fasteners shall be as specified in the individual Floor-Ceiling Design. Max diam of opening is 3 in. (76 mm).
2. **Through Penetrating Products* - Flexible Metal Piping**-Nom 2 in. (51 mm) diam (or smaller) steel Flexible Metal Piping with or without plastic covering on piping. Max one flexible metal piping to be installed near center of circular through opening in floor assembly. The annular space between the piping and periphery of opening shall be min 0 in. (0 mm) (point contact) to max 1/2 in. (13 mm). Piping to be rigidly supported on both sides of floor assembly.
OmegaFlex INC
3. **Fill, Void or Cavity Material* - Sealant** - Min 3/4 in. (19 mm) thickness of sealant applied within annulus on top surface of floor. Min 5/8 in. (16 mm) thickness of sealant applied within annulus on bottom surface of ceiling. At point contact location, a min 1/2 in. (13 mm) bead of sealant shall be applied to the penetrant/gypsum board interface on bottom surface of ceiling and at penetrant/flooring interface on top surface of floor.
Passive Fire Protection Partners** - 3600EX, 41GONS or 4800DW

*Bearing the UL Classification Marking

**Formerly Firestop Systems Inc.

APPENDIX B

MANUFACTURED HOUSING GUIDELINES

A. CODE AND ADMINISTRATIVE REQUIREMENTS

1. Manufactured homes and mobile homes bearing an insignia or required to bear an insignia must comply with Title VI 24 Code of Federal Regulations, The National Manufactured Housing Act of 1974 Part 3280. In most jurisdictions this requirement remains in force *when the structural, electrical plumbing or mechanical systems are altered*. The Code of Federal Regulations, Housing and Urban Development, Part 3280 *Manufactured Home Construction and Safety Standards* is applicable throughout the USA for manufactured housing construction (also known as “HUD code” housing).
2. There are other types of factory-built housing that do not fall directly under the classification “HUD code” which must also be reviewed for special installation considerations when designing a CSST gas piping system or appliance retrofit. Some examples of this type of housing are Assembly Buildings, Panelized, Modular, and Production Build. **TracPipe** should not be considered for RVs, which are subject to over the road use and not just initial placement or repositioning.
3. Part 3280 *Manufactured Home Construction and Safety Standards 1994* has not been revised or updated for several years. There has been an effort by both NFPA and CABO (now a part of the ICC) to have the US Congress adopt a new Manufactured Housing Code. The latest version of the CABO Code *ICC/ANSI 2.0 Manufactured Housing Construction Safety Standards* is available but has not been adopted by Congress.
4. Omegaflex has obtained a written opinion from the U.S. Department of Housing and Urban Development regarding the use of **TracPipe** CSST. This HUD decision states “CSST, such as **TracPipe**, is allowed to be used in HUD manufactured homes (based upon incorporation of *NFPA 54-1992 ANSI 223.1 The National Fuel Gas Code* into Section 3280.703 Minimum Standards).” This opinion shall be confirmed with State authorities responsible for inspections of HUD Code buildings prior to installing **TracPipe** after the home has left the factory. For factory installations, approval by the DAPIA (Manufacturer’s Design Approval Primary Inspection Agency) is normally required for the piping system design. Contact Omegaflex for specification data and a copy of the HUD decision letter.

B. PIPING SYSTEM DESIGN REQUIREMENTS

1. The primary information for any **TracPipe** installation is contained in the **TracPipe Design Guide and Installation Instructions** (latest edition). This guide provides manufacturer’s instructions that are a requirement of the ANSI/CSA LC-1 Standard governing certification and test requirements for Corrugated Stainless Steel Tubing. Manufacturer’s instructions must be followed.

2. Sizing for gas piping systems in HUD Code homes must be performed in accordance with Part 3280 (Natural Gas piping system acceptable for LP-gas). System sizing is to be done with Low Pressure Capacity Charts utilizing 0.5-inch water column drop. (see Chart N-1 in the **TracPipe** Design Guide)
3. The natural gas supply connections shall not be less than the size of the gas piping but shall not be smaller than 3/4-inch nominal pipe size. Gas supply connection shall not be beneath an exit door. Gas supply connection shall be rigidly anchored to a structural member within 6 inches of supply connection. All exterior openings around piping shall be sealed to resist the entrance of rodents.
4. Where fuel gas piping is to be installed in more than one section of an expandable or multiple-unit home, crossover connections between sections of the home shall be constructed by one of the following methods:
 - A. Listed quick disconnect device, designed to provide a positive seal of the supply side of the gas piping system when such device is separated.
 - B. Flexible connectors listed for exterior use and a shutoff valve of the non-displaceable rotor type conforming to ANSI Z21.15, installed on supply side.
 - C. Direct plumbing (CSST) sized in accordance with Natural Gas Low Pressure Capacity Chart N-1 (see above).
5. The flexible connector, direct plumbing pipe or “quick-disconnect” device shall be provided with protection from mechanical and impact damage and located to minimize the possibility of tampering. For gas line crossover connections made with CSST or flexible connectors, the crossover points shall be capped on the supply side to provide a positive seal and covered on the other side with a suitable protective covering.
6. All points of crossover shall be accessible from the exterior of the home.

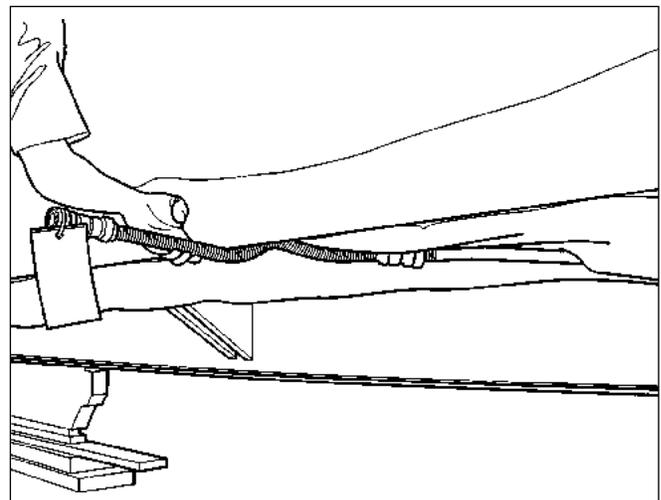
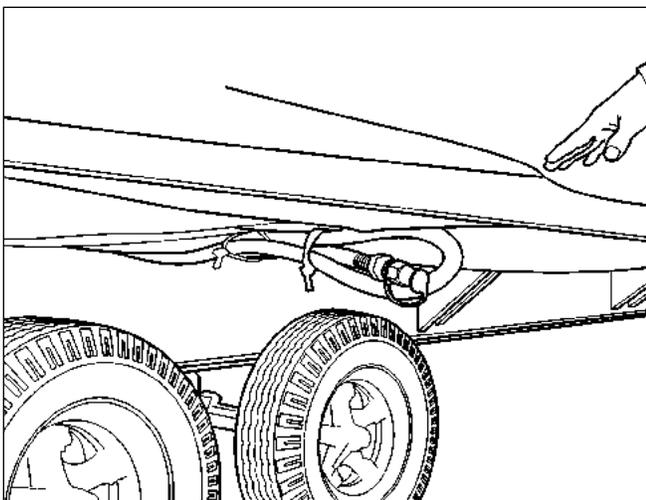

C. INSTALLATION REQUIREMENTS

1. The preferred location for CSST flexible gas piping is beneath the floor and inside or above the I-beam flange. This location will provide the best protection from transit damage. Appliance stub-outs are easily made utilizing termination mounts or flange mounts rigidly attached to the floor. Final connections can be made with approved flexible appliance connectors downstream from the appliance shut-off valve. All floor penetrations shall be sealed to resist the entrance of rodents. All CSST should be within the envelope or rigidly attached to the I-beam flange.
2. Where CSST must cross an I-beam flange, the piping shall be securely attached to the house flange to protect the CSST. Angle iron, C-channel or a wooden block are recommended means of attachment. It is preferred to drill through a wooden structural member if possible to avoid crossing the flange.
3. In open joist construction, routing should be within the open web portion of the fabricated joist wherever possible. This location provides necessary support points at each joist location.
4. In all locations, CSST must be supported in accordance with the manufacturer's instructions (every 4 feet-3/8 size, 6 feet-1/2 size, 8 feet-3/4 size and 1 inch size) Support should be with metal EMT conduit straps or two-point attachment plastic clips suitable for the size of the tubing.

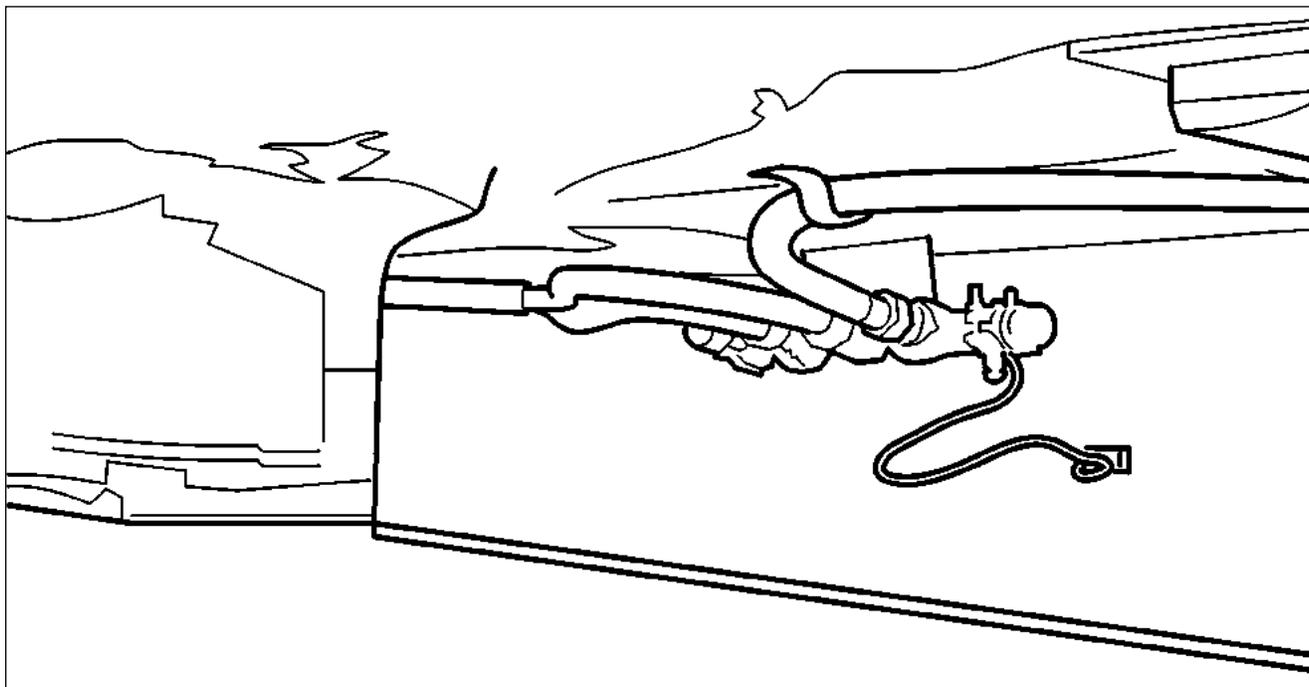

5. If a manifold is used, it shall be rigidly mounted to the I-beam flange. This applies to parallel system layouts. Gas pressure in HUD Code homes is limited to 14 inches water column maximum. Line pressure regulators are not necessary for this pressure and should not be used.

6. The gas piping shall be bonded to the frame of the home by the use of:
 - a. Solderless type grounding terminal with a star washer bolted to the chassis;
 - b. Grounding clamp attached to a gas piping fitting. (For attachment of clamp to **TracPipe** fitting, refer to Section 4.10 – Electrical Bonding/Grounding. Do not clamp to the stainless steel portion under any circumstances.); and
 - c. A bonding conductor of #8 copper wire.
7. Concealed tubing: CSST shall not be run inside walls, partitions or roofs. Where tubing passes through walls, floors, partitions, roofs, or similar installations, such tubing shall be protected by the use of weather resistant grommets that shall snugly fit both the tubing and the hole through which the tubing passes. DO NOT remove the yellow polyethylene jacket in any penetrations.
8. All CSST tubing joints shall have any exposed sections of stainless steel piping wrapped with silicone self-bonding tape. The under-floor portion of the manufactured home is considered an outdoor location. Proper support (per item 4 above) is required under the floor.
9. Retrofit of appliances:
 - a. The gas supply connection shall be rigidly anchored to a structural member within 6 inches of supply connection.
 - b. CSST shall be supported and protected per manufacturer's instructions. (See items 4 and 7 above.)
 - c. Pressure test gas piping per Item D 1 below before operating appliance.

D. INSPECTION AND TEST REQUIREMENTS

1. Pressure test in accordance with Part 3280.705k (8) testing for leakage (8 i) before appliances are connected and (8 ii) after appliances are connected.



OMEGAFLEX®

451 Creamery Way

Exton, PA 19341-2509

610-524-7272 Fax: 610-524-7282

www.omegaflex.com

1-800-671-8622