

You can't beat the system.®

# Plastics

TECHNICAL AND INSTALLATION MANUAL

**ABS DWV**  
**ABS Plus® Foam Core**  
**PVC DWV**  
**ConnecTite® Push-Fit DWV Fittings**  
**PVC Sewer & Pressure Pipe**  
**PVC Schedule 40 & 80**  
**FlowGuard Gold® CTS CPVC**  
**Corzan® Schedule 80 CPVC**

[Updated April 4, 2022]



Monroe, North Carolina



Muncy, Pennsylvania



Cameron, Texas



Wildwood, Florida

Charlotte Pipe® has been relentless in our commitment to quality and service for more than a century. Through the years we have broadened and enhanced our product lines to better serve our customers. As the leading full-line manufacturer of ABS, CPVC, and PVC piping systems for drainage and pressure applications, we welcome the opportunity to be the one-stop source for all your thermoplastic piping systems. Charlotte® manufactures pipe and fittings to exacting tolerances. Our systems are designed to fit together precisely for easier installation, fewer callbacks and a lifetime of trouble-free service - the major benefits of a Charlotte Pipe system.

**You can't beat the system.®**



Huntsville, Alabama



Cedar City, Utah

**CHARLOTTE**  
PIPE AND FOUNDRY COMPANY®

## Manufacturing Facilities

- Monroe, North Carolina
- Muncy, Pennsylvania
- Cameron, Texas
- Wildwood, Florida
- Huntsville, Alabama
- Cedar City, Utah



Download our Tech Tools App for dimensional info, tech calculators and more on your mobile device.



Charlotte Pipe, Charlotte, ConneCTite, and "You can't beat the system" are registered trademarks of Charlotte Pipe and Foundry Company.

MEMBER OF  
**ASTM**

# TABLE OF CONTENTS

<b>GENERAL INFORMATION</b>	<b>Page</b>
<b>Introduction</b> .....	2
<b>Understanding Safety-Alert Messages</b> .....	5
<b>Major Advantages of ABS, CPVC, and PVC Pipe</b> .....	6
<b>Handling and Storage of ABS, CPVC, and PVC Pipe</b> .....	7
<b>Physical Properties of ABS and PVC Materials</b> .....	8
<b>ABS and PVC Standards</b> .....	8
<b>Physical Properties of FlowGuard Gold® and Corzan® CPVC Materials</b> .....	9
<b>CPVC Standards</b> .....	9
<b>Product Certification</b> .....	10
<b>PRODUCT DATA</b>	
<b>Pipe Reference Guide</b> .....	11
<b>Material for Drain, Waste, &amp; Vent (DWV) Not for Pressure</b> .....	12
<b>Product Data (Dimensions, Weight, and Pressure Ratings)</b> .....	13-28
<b>Materials for Pressurized Systems</b> .....	20
<b>Socket Dimensions for Belled-End Pipe</b> .....	27
<b>CPVC Copper Tube Size Pipe</b> .....	28
<b>DESIGN AND ENGINEERING INFORMATION</b>	
<b>Pressure/Temperature Relationship</b> .....	29
Pressure Rating of Fittings, Flanges, and Unions .....	30
PVC Schedule 40 Pressure Ratings .....	31
PVC Schedule 80 Pressure Ratings .....	31
Important Information on Threaded Connections .....	32-33
Taper Thread Dimensions .....	34
<b>Fluid Flow Properties</b> .....	35-43
Gravity Flow .....	35
Fluid Flow Rate .....	35
Pressure Flow Rate .....	36
Water Velocities .....	36
Friction Loss Through Fittings .....	36
Friction Loss and Flow Velocity Table .....	37-41
Water Hammer .....	42-43
Entrapped Air .....	44
Weathering / UV Exposure / Heat Build-Up .....	44
<b>Horizontal and Vertical Support for ABS, CPVC, and PVC Pipe</b> .....	45
<b>Typical Pipe Hangers, Clamps, and Supports</b> .....	46-47
<b>Expansion and Contraction of ABS, CPVC, and PVC</b> .....	48-50
Thermal Expansion in DWV Systems .....	49
Thermal Expansion in Underground Systems .....	49
Permissible Bending Deflections for FlowGuard Gold® Pipe .....	50
<b>Flame Spread Index (FSI) and Smoke Developed Index (SDI) Rating for ABS, CPVC, and PVC</b> .....	51
<b>INSTALLATION</b>	
<b>Installation Procedures for ABS, CPVC, and PVC Piping Systems</b> .....	52-76
Cutting, Joint Preparation and Solvent Cement .....	52
Solvent Cements .....	53
Applicator Types .....	53
Joint Curing .....	54
FlowGuard Gold CTS Installation Procedures .....	55-56
1/2"-4" ABS, CPVC, and PVC Iron Pipe Size Installation Procedures .....	57-59
6" and Larger ABS, CPVC, and PVC Iron Pipe Size Installation Procedures .....	60-63

# TABLE OF CONTENTS

Repairs of Modifications to Existing ABS, CPVC, or PVC Systems.....	63
Repair Coupling Installation .....	64
ConnectTite® Installation Procedures .....	65-66
Installation of Brass and CPVC Threaded Fittings.....	67
Installation of ABS, CPVC, and PVC Threaded Connections.....	68
Flanges .....	69
Unions .....	70
Procedure for Cutting Threads in Schedule 80 Pipe.....	71
Joining Roll-Grooved Pipe .....	72
Gasketed Pipe Assembly .....	72
Joint Insertion Instructions .....	72-73
Underground Installation .....	73-74
Unstable Soil .....	74
CTS CPVC Under-Slab Installations .....	74
In-Slab Installations .....	74
Testing and Inspection .....	75
Testing DWV System .....	75
Alternate Test Methods .....	75-76
Testing Pressure System .....	76
<b>ADDITIONAL CONSIDERATIONS</b>	
Antifreeze Solutions for ABS DWV, Pressure PVC, and Pressure CPVC Systems .....	77
Low Temperature and Cold Weather Conditions .....	78
Disinfection .....	79
Advantages of a FlowGuard Gold CPVC System .....	79
Chemical Compatibility with CPVC Products .....	79
Closed-Loop Systems .....	80
Connecting CTS CPVC to Fixtures or Other Materials .....	80
FlowGuard Gold and Corzan Domestic Water Systems Do's and Dont's .....	80-81
Water Heaters/Boilers .....	82
T/P Relief Valve Drainage Pipe .....	82
HVAC Condensate Drain Lines .....	83
Thermal Expansion .....	83
R-Values and Thermal Conductivity .....	84
Hydronic Heating, Chilled Water or Geothermal Applications .....	85-86
Material Selection, Special System Design and Engineering Considerations .....	87-88
Selection of Material for Sanitary and Storm Drainage .....	87
Using Plastics in Multi-Story Construction .....	87
Engineered Applications .....	88
Using Plastics for Combustion Gas Venting .....	88
PVC Schedule 80 Pipe for DWV Applications .....	89
Chemical Resistance of ABS, CPVC, and PVC .....	90-110
<b>HELPFUL REFERENCES</b>	
Reference Standards Plastics .....	111-114
Conversion Charts .....	115-116
<b>LIMITED WARRANTY .....</b>	
<b>FLOWGUARD GOLD CPVC CTS LIMITED WARRANTY .....</b>	<b>119</b>

## Understanding Safety Alert Messages

It is important to read and understand this manual. It contains information to help protect your safety and prevent problems.



This is the safety alert symbol. It is used to alert you to potential personal injury hazards. Obey all safety messages that follow this symbol to avoid personal injury or death.

### **WARNING**

“WARNING” Indicates a hazardous situation which, if not avoided, could result in severe injury or death.

### **CAUTION**

“CAUTION” Indicates a hazardous situation which, if not avoided, could result in minor or moderate injury.

### **NOTICE**

“NOTICE” Indicates a hazardous situation which, if not avoided, may result in system failure and property damage.

## Major Advantages of ABS, CPVC, and PVC Pipe

### **WARNING**

To reduce the risk of death or serious injury from an explosion, collapse or projectile hazard and to reduce the risk of property damage from a system failure:

- Always follow the warnings and procedures provided in this manual.
- Only use ABS / CPVC / PVC pipe and fitting for the conveyance of fluids as defined within the applicable ASTM standards.
- Never use ABS / CPVC / PVC pipe and fittings for the conveyance of gasses.
- Never use ABS / CPVC / PVC pipe or fittings in structural application or in any load-bearing applications.
- Never strike the pipe or fittings or drive them into the ground or into any other hard substance.

- While ABS, CPVC, and PVC are very different materials, they share numerous advantages common to plastic piping systems. Advantages include ease of installation, corrosion resistance, low friction loss, initial cost, and longevity.

### Easy Installation

- ABS, CPVC, and PVC systems are light in weight (approximately one-half the weight of aluminum and one-sixth the weight of steel) reducing transportation, handling, and installation cost. They have smooth, seamless interior walls. No special tools are required for cutting. These materials can be installed using the solvent cement joining technique.

### Strength

- ABS, CPVC, and PVC products are highly resilient, tough and durable with high tensile and high impact strength.

### Freedom from Toxicity, Odors, Tastes

- CPVC and PVC piping systems designed for domestic water applications are listed to conform to NSF International Standard 61. This Health Effects standard ensures the safety of products coming into contact with drinking water.

### Corrosion Free External and Internal

- With many other pipe materials, slight corrosion may occur. The corroded particles can contaminate the piped fluid, complicating further processing, or causing bad taste, odors, or discoloration. This is particularly undesirable when the piped fluid is for domestic consumption. With PVC and CPVC, there are no corrosive by-products, therefore, no contamination of the piped fluid.

### Immunity to Galvanic or Electrolytic Attack

- ABS, CPVC, and PVC are inherently immune to galvanic or electrolytic action. They can be used underground, underwater, in the presence of metals, and can be connected to metals.

### Low Friction Loss

- The smooth interior surfaces of ABS, ABS Plus, CPVC and PVC assure low friction loss and high flow rate. Additionally, since ABS, CPVC, and PVC pipe resist rusting, pitting, scaling and corrosion, the high flow rate can be maintained for the life of the piping system.

### Low Thermal Conductivity

- CPVC and PVC pipe have a much lower thermal conductivity factor than metal pipe. Therefore, fluids being piped maintain a more constant temperature. In many cases, pipe insulation is not required.

### Cost Effective

- ABS, CPVC, and PVC products are extremely light weight, convenient to handle, relatively flexible, and easy to install. These features lead to lower installed cost than other piping systems.

---

To the best of our knowledge the information contained in this publication is accurate. However, Charlotte Pipe and Foundry does not assume any liability whatsoever for the accuracy or completeness of such information. Final determination of the suitability of any information or product for the use to be contemplated is the sole responsibility of the user. The manner of that use and whether there is any infringement of patents is also the sole responsibility of the user.



## Virtually Maintenance Free

- Once an ABS, CPVC, or PVC system is properly selected, designed, and installed, it is virtually maintenance free. Therefore, years of trouble-free service can be expected when using Charlotte Pipe and Foundry ABS, CPVC, and PVC systems.

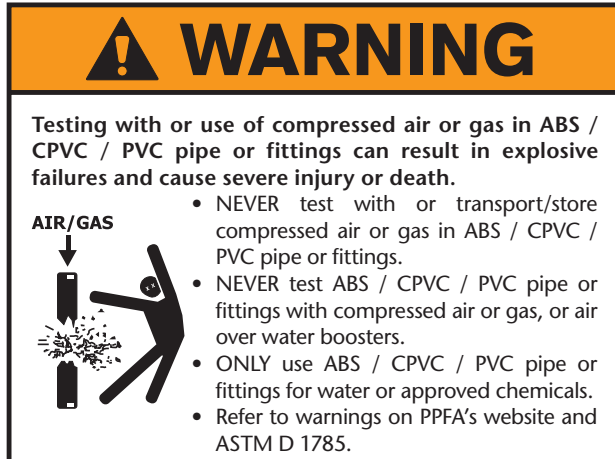

## Handling and Storage of ABS, CPVC, and PVC

### Receiving Pipe

As pipe is received, it must always be thoroughly inspected, prior to unloading. The person receiving the pipe must look for any transportation damage caused by over-tightened tie-down straps, improper treatment, or a shift in the load.

Pipe received in a closed trailer must be inspected as the trailer is opened. Take extra time to ensure that the pipe has not been damaged by other materials having been stacked on top of it, load shift, or rough handling.

Visually examine the pipe ends for any cracks, splits, gouges, or other forms of damage. Additionally, the pipe should be inspected for severe deformation which could later cause joining problems. The entire inside diameter of larger diameter pipe (4" and above) must be checked for any internal splits or cracks which could have been caused by loading or transit. The use of a flashlight may be necessary to perform this inspection.

Any damages must be observed by all parties involved, including the driver, and should be clearly noted on the bill of lading and/or delivery ticket. A copy of this document should be retained by the receiver. In addition, the manufacturer and carrier should be notified, within 24 hours, of any damages, shortages, or mis-shipped products.

### Handling Pipe

The pipe should be handled with reasonable care. Because thermoplastic pipe is much lighter in weight than metal pipe, there is sometimes a tendency to throw it around. This should be avoided.

The pipe should never be dragged or pushed from a truck bed. Removing and handling pallets of pipe should be done with a forklift. Loose pipe lengths require special handling to avoid damage. Precautions to follow when unloading and handling loose pieces include not banging lengths together or dropping lengths, even from low heights, on hard or uneven surfaces.

In all cases, severe contact with any sharp objects (rocks, angle irons, forks on forklifts, etc.) should be avoided. Also, the pipe should never be lifted or moved by inserting the forks of a forklift into the pipe ends.

Handling PVC and particularly CPVC pipe diameters greater than 4-inch requires extra care as the added pipe weight can cause cracking from relatively minor impacts. Also, plastic pipe becomes more brittle as the temperature decreases. The impact strength and flexibility of PVC and especially CPVC pipe are reduced. Therefore, take extra care when handling skids or loose lengths when the temperature drops below 50°F.

### Storage

Plastic pipe and fittings can be stored indoors or outdoors. If stored outdoors, pipe and fittings should be stored under a ventilated non-transparent cover. If different schedules of pipe are stacked together, the pipe with the thickest walls should be on the bottom.

If the pipe is in pallets, the pallets should be stacked with the pallet boards touching, rather than pallet boards being placed on the pipe. This will prevent damage to or bowing of the pipe.

If the pipe is stored in racks, it should be continuously supported along its length. If this is not possible, the spacing supports should be determined based on the pipe diameter. In general, supports and spacing that would provide for no more than 1/2" in deflection of the pipe should be acceptable.

The pipe and fittings should be protected from the sun and be in an area with proper ventilation. This will lessen the effects of ultraviolet rays and help prevent heat build-up. Handling the products properly can help to eliminate any possible safety hazards.

**See also:** Repairs or Modifications to existing systems

# GENERAL INFORMATION

## Physical Properties of Charlotte Pipe® ABS and PVC Materials\*

PROPERTY	UNITS	ABS	ASTM NO.	PVC	ASTM NO.
Specific Gravity	g/cc	1.05	D 792	1.40	D 792
Tensile Strength (73°F) Minimum	Psi	4,500	D 638	7,000	D 638
Modulus of Elasticity in Tension (73°F) Minimum	Psi	240,000	D 638	400,000	D 638
Flexural Strength (73°F)	Psi	10,585	D 790	14,000	D 790
Izod Impact (notched at 73°F) Minimum	ft lb/ in. of notch	6.00	D 256	0.65	D 256
Hardness (Durometer D)		70	D 2240	80 ± 3	D 2240
Hardness (Rockwell R)		100	D 785	110 - 120	D 785
Compressive Strength (73°F)	Psi	7,000	D 695	9,600	D 695
Hydrostatic Design Stress	Psi	N/A		2,000	D 1598
Coefficient of Linear Expansion	in./ in./ °F	5.5 x 10 <sup>-5</sup>	D 696	3.0 x 10 <sup>-5</sup>	D 696
Heat Distortion Temperature at 264 psi Minimum	degrees F	180	D 648	158	D 648
Coefficient of Thermal Conductivity	BTU/ hr/sq ft/ °F/ in.	1.1	C 177	1.2	C 177
Specific Heat	BTU/ °F/lb	0.35	D 2766	0.25	D 2766
Water Absorption (24 hrs at 73°F)	% weight gain	0.40	D 570	.05	D 570
Cell Classification - Pipe		42222	D 3965	12454	D 1784
Cell Classification - Fittings		32222	D 3965	12454	D 1784
Burning Rate				Self Ext.	D 635

\*Above data is based upon information provided by the raw material manufacturers. It should be used only as a recommendation and not as a guarantee of performance.

## ABS and PVC Standards

TYPE PIPE / FITTING	STANDARD SPECIFICATIONS	
	MATERIAL	DIMENSIONS
<b>ABS DWV</b>		
Schedule 40 DWV Foam Core Pipe	ASTM D 3965	ASTM F 628
Schedule 40 DWV Fittings	ASTM D 3965	ASTM D 2661
ABS Plus® Schedule 40 DWV Foam Core Pipe	ASTM D 3965 & ASTM D 4396	ASTM F 1488
<b>PVC DWV</b>		
Schedule 40 DWV Pipe	ASTM D 1784	ASTM D 2665 & ASTM D 1785
Schedule 40 DWV Foam Core Pipe	ASTM D 4396	ASTM F 891
Schedule 40 DWV Fittings	ASTM D 1784	ASTM D 2665
Fabricated Schedule 40 DWV Fittings	ASTM D 1784	ASTM F 1866
<b>PVC Pressure</b>		
Schedule 40 Plain End Pipe	ASTM D 1784	ASTM D 1785
Schedule 40 Bell End Pipe	ASTM D 1784	ASTM D 1785
Schedule 40 Bell End Well Casing	ASTM D 1784	ASTM D 1785 & ASTM F 480
SDR 21 (PR 200) Bell End Pipe	ASTM D 1784	ASTM D 2241
SDR 26 (PR 160) Bell End Pipe	ASTM D 1784	ASTM D 2241
Schedule 40 Fittings	ASTM D 1784	ASTM D 2466
Schedule 80 Plain End Pipe	ASTM D 1784	ASTM D 1785
Schedule 80 Fittings	ASTM D 1784	ASTM D 2464 & ASTM D 2467



## Physical Properties of FlowGuard Gold® & Corzan® CPVC Materials\*

PROPERTY	CPVC 4120	UNITS	ASTM No.
Specific Gravity	1.55	g/cc	D 792
Tensile Strength (73°F) Minimum	7,000	psi	D 638
Modulus of Elasticity in Tension (73°F)	360,000	psi	D 638
Flexural Strength (73°F)	15,100	psi	D 790
Izod Impact Cell Class 23447 (notched at 73°F) Minimum	1.5	ft lb/ in. of notch	D 256
Izod Impact Cell Class 24448 (notched at 73°F) Minimum	5.0	ft lb/ in. of notch	D 256
Hardness (Durometer D)	—		D 2240
Hardness (Rockwell R)	119		D 785
Compressive Strength (73°F)	10,100	psi	D 695
Hydrostatic Design Stress	2,000	psi	
Coefficient of Linear Expansion	3.4 x 10 <sup>-5</sup>	in./ in./ °F	D 696
Heat Distortion Temperature at 264 psi Minimum	212 (Cell Class 23447)	degrees F	D 648
Heat Distortion Temperature at 264 psi Minimum	230 (Cell Class 24448)	degrees F	D 648
Coefficient of Thermal Conductivity	.95	BTU/ hr/sq ft/ °F/ in.	C 177
Specific Heat	.34	BTU/ °F/lb	D 2766
Water Absorption (24 hrs at 73°F)	.03	% weight gain	D 570
Cell Classification	23447 - 24448		D 1784
Burning Rate	Self Extinguishing		D 635

\*Above data is based upon information provided by the raw material manufacturers. It should be used only as a recommendation and not as a guarantee of performance.

## CPVC Standards

TYPE PIPE / FITTINGS	STANDARD SPECIFICATIONS	
	MATERIAL	DIMENSIONS
<b>CPVC Pressure</b>		
CPVC Schedule 80 Plain End Pipe (Corzan)	ASTM D 1784	ASTM F 441
CPVC Schedule 80 Fittings (Corzan)	ASTM D 1784	ASTM F 437 and ASTM F 439
CPVC CTS Tube and Fittings (FlowGuard Gold)	ASTM D 1784	ASTM D 2846

## Product Certification



This is to certify that all Plastic Pipe and Fittings manufactured by Charlotte Pipe and Foundry Company are manufactured in the United States and conform to the following standards:

### **PVC SCH. 40 SOLID WALL PIPE**

ASTM D 1784, ASTM D 1785, ASTM D 2665  
FHA UM 79a  
FEDERAL SPECIFICATION L-P-320a  
NSF STANDARD 14 AND 61

### **PVC SCH. 40 DWV CELLULAR CORE PIPE**

ASTM D 4396, ASTM F 891  
NSF STANDARD NO. 14

### **PVC SCH. 40 DWV FITTINGS**

ASTM D 1784, ASTM D 2665, ASTM D 3311,  
ASTM F1866  
FHA UM 79a  
FEDERAL SPECIFICATION L-P-320a  
NSF STANDARD NO. 14

### **ConnecTite® PUSH-FIT DWV FITTINGS**

ASME A112.4.4, IAPMO IGC 334  
NSF STANDARD NO. 14

### **PVC SDR-21 AND SDR-26 PRESSURE PIPE**

ASTM D 1784, ASTM D 2241  
NSF STANDARD NO. 14 AND 61

### **PVC SCH. 40 PRESSURE FITTINGS**

ASTM D 1784, ASTM D 2466  
NSF STANDARD 14 AND 61

### **PVC SCH. 40 WELL CASING PIPE**

ASTM D 1784, ASTM F 480  
NSF STANDARD NO. 14 AND 61

### **PVC SCH. 80 PIPE**

ASTM D 1784, ASTM D 1785  
NSF STANDARD NO. 14 AND 61

### **PVC SCH. 80 FITTINGS**

ASTM D 1784, ASTM D 2467  
ASTM D 2464 ASTM F 1970  
NSF STANDARD NO. 14 AND 61

### **PVC SDR 35 SEWER MAIN PIPE**

ASTM D 1784, ASTM D 3034, SDR 35  
ASTM D 3212, ASTM F 477

### **PVC SEWER AND DRAIN PIPE**

ASTM D 1784, ASTM D 2729

### **PVC THIN WALL PIPE & FITTINGS**

ASTM D 1784, ASTM D 2949  
NSF STANDARD NO. 14

### **CPVC FLOWGUARD GOLD® CTS PIPE & FITTINGS**

ASTM D 1784, ASTM D 2846  
FHA UM-61a  
NSF STANDARD NO. 14 AND 61  
CSA LISTED ON SPECIFIED ITEMS

### **CPVC CHEMDRAIN® SCH. 40 PIPE & FITTINGS**

ASTM D 1784, ASTM F 2618  
NSF STANDARD 14

### **ABS SCH. 40 DWV CELLULAR CORE PIPE**

ASTM D 3965, ASTM F 628  
NSF STANDARD NO. 14

### **ABS PLUS® SCH. 40 DWV CELLULAR CORE PIPE**

ASTM D 3965, ASTM D 4396, ASTM F 1488

### **ABS SCH. 40 DWV FITTINGS**

ASTM D 3965, ASTM D 2661, ASTM D 3311  
FHA UM 79a  
FEDERAL SPECIFICATION L-P-322b  
NSF STANDARD NO. 14

CHARLOTTE PIPE AND FOUNDRY COMPANY



## Pipe Reference Guide



Product	Sizes Available																			
	1/4	3/8	1/2	3/4	1	1 1/4	1 1/2	2	2 1/2	3	4	5	6	8	10	12	14	15	16	
ChemDrain® CPVC Schedule 40 ★							●	●		●	●		●	●						
FlowGuard Gold® CPVC CTS SDR 11			●	●	●	●	●	●												
PVC Schedule 80	●	●	●	●	●	●	●	●	●	●	●	●	●	●	●	●	●	●	●	●
PVC Schedule 40			●	●	●	●	●	●	●	●	●	●	●	●	●	●	●	●	●	●
PVC Schedule 40 DWV ★						●	●	●		●	●	●	●	●	●	●	●	●	●	●
PVC Schedule 30 ★										●										
PVC DWV Foam Core ★							●	●		●	●		●	●	●	●				
PVC Well Casing								●	●	●	●		●	●	●	●	●		●	●
PVC SDR 13.5 (PR315)			●																	
PVC SDR 21 (PR200)				●	●	●	●	●	●	●	●		●							
PVC SDR 26 (PR160)						●	●	●	●	●	●		●							
PVC SDR 35 Sewer Main Belled-End ★†											●		●							
PVC SDR 35 Sewer Main Gasketed ★†											●		●	●						
PVC D 2729 Sewer and Drain ★†											●	●		●						
ABS DWV Foam Core ★							●	●		●	●		●							
ABS Plus® Foam Core DWV★							●	●		●	●									

★ Non-Pressure

† Not NSF Listed

**You can't beat the system.®**

Notes:

1. End treatments are Plain and Belled. Consult factory for availability.
2. Lengths are 10 and 20 feet (14 and 20 feet for Gasketed Sewer Main). Consult factory for availability and non-standard lengths.
3. PVC Schedule 40 Bell End and PVC Well Casing pipe lengths for sizes 4", 6", and 8" are 20 feet plus the bell (20 foot laying length). The length for all other sizes of Schedule 40 Bell End pipe and PVC Well Casing pipe are 20 feet, including the bell.
4. PVC SDR 35 Sewer Main Pipe in 14 foot lengths are 14 feet plus the bell (14 foot laying length).

## Materials for Drain, Waste, & Vent (DWV) Not for Pressure

### Typical DWV Applications:

- Drain household sanitary waste (kitchen and bathrooms)
- Sanitary sewer
- Drain ground water
- NOT for pressure applications

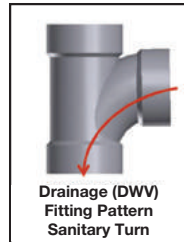

### Drainage (DWV) Fitting Pattern Sanitary Turn

DWV stands for:  
D = drains from tubs and sinks  
W = waste from toilets  
V = vents for air into/out of the system



### ABS Schedule 40 DWV Pipe and Fittings

Manufactured from acrylonitrile butadiene styrene

- Black in color
- More common in the western U.S.
- Use correct cement

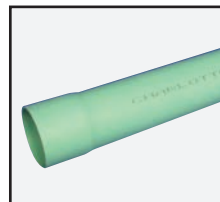

### PVC SDR 35 ASTM D 3034 Sewer Main Pipe

- Manufactured from polyvinyl chloride
- Green in color
- Used in sanitary sewer applications.
- Available in gasketed or solvent weld



### ABS Plus® Schedule 40 DWV Pipe and Fittings

- Manufactured from ABS/PVC composite
- Black in color
- More common in western U.S.
- Use correct cement

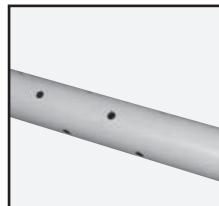

### PVC Sewer and Drain Pipe

- Manufactured from polyvinyl chloride
- Available in Belled End only
- Perforated (two-hole pattern) or solid wall



### PVC Schedule 40 DWV Pipe and Fittings

- Manufactured from polyvinyl chloride
- White in color
- Use correct primer and cement



### PVC ConnectTite® Push-Fit DWV Fittings

- Manufactured from polyvinyl chloride
- Requires no primer or solvent cement.
- Non-pressure applications only
- Reusable and reversible



### PVC Schedule 40 Foam Core DWV Pipe and Fittings

- Manufactured from polyvinyl chloride with a cellular core
- White in color
- Use correct primer and cement

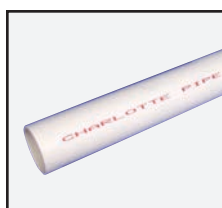

### PVC Thin Wall Schedule 30 DWV Pipe and Fittings

- Manufactured from polyvinyl chloride
- White in color
- 3" diameter

## ⚠ WARNING

Testing with or use of compressed air or gas in ABS / CPVC / PVC pipe or fittings can result in explosive failures and cause severe injury or death.

- NEVER test with or transport/store compressed air or gas in ABS / CPVC / PVC pipe or fittings.
- NEVER test ABS / CPVC / PVC pipe or fittings with compressed air or gas, or air over water boosters.
- ONLY use ABS / CPVC / PVC pipe or fittings for water or approved chemicals.
- Refer to warnings on PFA's website and ASTM D 1785.

AIR/GAS

# ABS Foam Core DWV Pipe



>> **ABS Schedule 40 DWV Pipe**

ABS SCHEDULE 40 FOAM CORE (BLACK)		PLAIN END	FOR NON-PRESSURE APPLICATIONS		ASTM F 628
PART NO.	NOM. SIZE	UPC # 611942-	AVG. OD (IN.)	MIN. WALL (IN.)	WT. PER 100 FT. (LBS.)
ABS 3112	1½" x 10'	03132	1.900	0.145	27.1
ABS 3112	1½" x 20'	03133	1.900	0.145	27.1
ABS 3200	2" x 10'	03134	2.375	0.154	37.7
ABS 3200	2" x 20'	03135	2.375	0.154	37.7
ABS 3300	3" x 10'	03136	3.500	0.216	74.5
ABS 3300	3" x 20'	03137	3.500	0.216	74.5
ABS 3400	4" x 10'	03138	4.500	0.237	107.1
ABS 3400	4" x 20'	03139	4.500	0.237	107.1
ABS 3600	6" x 10'	03140	6.625	0.280	187.8
ABS 3600	6" x 20'	03141	6.625	0.280	187.8

NSF Listed. Meets All Requirements of ASTM F 628.

cNSF® us-dwv approved

## NOTICE

**NOT FOR PRESSURE**

Do not use ABS / ABS Plus® / PVC cellular core (foam core) pipe for pressure applications. The use of cellular core pipe in pressure applications may result in system failure and property damage.

## WARNING

Testing with or use of compressed air or gas in ABS / CPVC / PVC pipe or fittings can result in explosive failures and cause severe injury or death.

AIR/GAS

- NEVER test with or transport/store compressed air or gas in ABS / CPVC / PVC pipe or fittings.
- NEVER test ABS / CPVC / PVC pipe or fittings with compressed air or gas, or air over water boosters.
- ONLY use ABS / CPVC / PVC pipe or fittings for water or approved chemicals.
- Refer to warnings on PPFA's website and ASTM D 1785.

# ABS Plus® Foam Core DWV Pipe

ABS Plus is a registered trademark of Charlotte Pipe and Foundry Company.



## >> ABS Plus® Schedule 40 DWV Pipe (For Non-Pressure Applications)

ABS PLUS® SCHEDULE 40 DWV PIPE (BLACK)				PLAIN END		ASTM F 1488
PART NO.	NOM. SIZE	UPC # 611942-	QTY. PER SKID	AVG. OD (IN.)	MIN. WALL (IN.)	WT. PER 100 FT. (LBS.)
APA 17112	1½" x 10'	12495	2590'	1.900	0.145	31.4
APA 17112	1½" x 20'	12494	5180'	1.900	0.145	31.4
APA 17200	2" x 10'	12497	1670'	2.375	0.154	41.9
APA 17200	2" x 20'	12496	3340'	2.375	0.154	41.9
APA 17300	3" x 10'	12499	750'	3.500	0.216	84.0
APA 17300	3" x 20'	12498	1500'	3.500	0.216	84.0
APA 17400	4" x 10'	12501	480'	4.500	0.237	118.8
APA 17400	4" x 20'	12500	960'	4.500	0.237	118.8

NSF Listed. Meets All Requirements of ASTM F 1488.

All products manufactured by Charlotte Pipe and Foundry Company are proudly made in the U.S.A.

## NOTICE

### NOT FOR PRESSURE

Do not use ABS / ABS Plus® / PVC cellular core (foam core) pipe for pressure applications. The use of cellular core pipe in pressure applications may result in system failure and property damage.

## ⚠ WARNING

Testing with or use of compressed air or gas in ABS / CPVC / PVC pipe or fittings can result in explosive failures and cause severe injury or death.

AIR/GAS



- NEVER test with or transport/store compressed air or gas in ABS / CPVC / PVC pipe or fittings.
- NEVER test ABS / CPVC / PVC pipe or fittings with compressed air or gas, or air over water boosters.
- ONLY use ABS / CPVC / PVC pipe or fittings for water or approved chemicals.
- Refer to warnings on PPFA's website and ASTM D 1785.



# PVC Foam Core DWV Pipe



>> PVC Schedule 40 DWV Pipe

PVC SCHEDULE 40 FOAM CORE (WHITE)		PLAIN END	FOR NON-PRESSURE APPLICATIONS		ASTM F 891
PART NO.	NOM. SIZE	UPC # 611942-	AVG. OD (IN.)	MIN. WALL (IN.)	WT. PER 100 FT. (LBS.)
PVC 4112	1½" x 10'	04178	1.900	0.145	32.3
PVC 4112	1½" x 20'	04177	1.900	0.145	32.3
PVC 4200	2" x 10'	04174	2.375	0.154	43.9
PVC 4200	2" x 20'	04173	2.375	0.154	43.9
PVC 4300	3" x 10'	03934	3.500	0.216	89.7
PVC 4300	3" x 20'	03935	3.500	0.216	89.7
PVC 4400	4" x 10'	03936	4.500	0.237	123.8
PVC 4400	4" x 20'	03937	4.500	0.237	123.8
PVC 4600	6" x 10'	03938	6.625	0.280	235.0
PVC 4600	6" x 20'	03939	6.625	0.280	235.0
PVC 4800	8" x 20'	03941	8.625	0.322	371.0
PVC 4910	10" x 20'	03942	10.750	0.365	566.3
PVC 4912	12" x 20'	03943	12.750	0.406	700.0

PVC SCHEDULE 40 FOAM CORE (WHITE)		BELL-END	FOR NON-PRESSURE APPLICATIONS		
PART NO.	NOM. SIZE	UPC # 611942-	AVG. OD (IN.)	MIN. WALL (IN.)	WT. PER 100 FT. (LBS.)
PVC 4300B	3" x 20'	04782	3.500	0.216	89.7
PVC 4400B	4" x 10'	04783	4.500	0.237	123.8
PVC 4400B	4" x 20'	04784	4.500	0.237	123.8
PVC 4600B	6" x 10'	09904	6.625	0.280	235.0
PVC 4600B	6" x 20'	04786	6.625	0.280	235.0

NOTE: When ordering, please specify plain end or bell-end.

NSF Listed. Meets All Requirements of ASTM F 891.

NOTICE

NOT FOR PRESSURE

Do not use ABS / ABS Plus® / PVC cellular core (foam core) pipe for pressure applications. The use of cellular core pipe in pressure applications may result in system failure and property damage.

⚠ WARNING

Testing with or use of compressed air or gas in ABS / CPVC / PVC pipe or fittings can result in explosive failures and cause severe injury or death.

AIR/GAS

- NEVER test with or transport/store compressed air or gas in ABS / CPVC / PVC pipe or fittings.
- NEVER test ABS / CPVC / PVC pipe or fittings with compressed air or gas, or air over water boosters.
- ONLY use ABS / CPVC / PVC pipe or fittings for water or approved chemicals.
- Refer to warnings on PFFA's website and ASTM D 1785.

# PVC Schedule 40 DWV Pipe



## >> PVC Schedule 40 DWV Pipe, Type 1, Grade 1

PVC SCHEDULE 40 (WHITE)		PLAIN END	PVC 1120	ASTM D 2665	
PART NO.	NOM. SIZE	UPC # 611942-	AVG. OD (IN.)	MIN. WALL (IN.)	WT. PER 100 FT. (LBS.)
PVC 7100*	1¼" x 10'	03945	1.660	.140	42.4
PVC 7100*	1¼" x 20'	03946	1.660	.140	42.4
PVC 7112*	1½" x 10'	03947	1.900	.145	51.8
PVC 7112*	1½" x 20'	03948	1.900	.145	51.8
PVC 7200*	2" x 10'	03949	2.375	.154	69.5
PVC 7200*	2" x 20'	03950	2.375	.154	69.5
PVC 7300*	3" x 10'	03951	3.500	.216	144.2
PVC 7300*	3" x 20'	03952	3.500	.216	144.2
PVC 7400†	4" x 10'	03953	4.500	.237	205.5
PVC 7400†	4" x 20'	03954	4.500	.237	205.5
PVC 7500†	5" x 20'	04837	5.563	.258	272.5
PVC 7600†	6" x 10'	03955	6.625	.280	361.2
PVC 7600†	6" x 20'	03956	6.625	.280	361.2
PVC 7800†	8" x 10'	13087	8.625	.322	543.6
PVC 7800†	8" x 20'	03958	8.625	.322	543.6
PVC 7910†	10" x 20'	03959	10.750	.365	770.7
PVC 7912†	12" x 20'	03961	12.750	.406	1019.0
PVC 7914†	14" x 20'	04862	14.000	.437	1205.0
PVC 7916†	16" x 20'	04918	16.000	.500	1575.7

\* Dual Marked ASTM D 1785 & ASTM D 2665.

† Triple Marked ASTM D 1785 & ASTM D 2665 & ASTM F 480

NSF Listed. Meets All Requirements of ASTM D 1784, ASTM D 1785, and ASTM D 2665.

WARNING

Testing with or use of compressed air or gas in ABS / CPVC / PVC pipe or fittings can result in explosive failures and cause severe injury or death.

AIR/GAS

- NEVER test with or transport/store compressed air or gas in ABS / CPVC / PVC pipe or fittings.
- NEVER test ABS / CPVC / PVC pipe or fittings with compressed air or gas, or air over water boosters.
- ONLY use ABS / CPVC / PVC pipe or fittings for water or approved chemicals.
- Refer to warnings on PFA's website and ASTM D 1785.

# Thin Wall PVC DWV Pipe

>> **PVC Thin Wall Schedule 30 Pipe**

PVC SCHEDULE 30 (WHITE)			PLAIN END		ASTM D 2949	
PART NO.	NOM. SIZE	UPC # 611942-	QTY. PER SKID	AVG. OD (IN.)	MIN. WALL (IN.)	WT. PER 100 FT. (LBS.)
PVC 9300	3" x 10'	03963	1250'	3.25	0.125	80.2

Weight is approximate and is for shipping purposes only.

Pipe listed in this section meets or exceeds the requirements of ASTM D 2949.

All products manufactured by Charlotte Pipe and Foundry Company are proudly made in the U.S.A.



## ⚠ WARNING

Testing with or use of compressed air or gas in ABS / CPVC / PVC pipe or fittings can result in explosive failures and cause severe injury or death.

AIR/GAS

- NEVER test with or transport/store compressed air or gas in ABS / CPVC / PVC pipe or fittings.
- NEVER test ABS / CPVC / PVC pipe or fittings with compressed air or gas, or air over water boosters.
- ONLY use ABS / CPVC / PVC pipe or fittings for water or approved chemicals.
- Refer to warnings on PPFA's website and ASTM D 1785.

# PVC Sewer Pipe

## >> PVC SDR 35 PSM Pipe

ASTM D 3034 & ASTM F 477

SDR-35		GASKETED - PS 46					
PART NO.	NOM. SIZE	UPC # 611942-	QTY. PER SKID	LAYING LENGTH	WT. PER 100 FT. (LBS.)	AVG. OD (IN.)	MIN. WALL (IN.)
S/M 6004G	4" x 14'	11920	938'	14'-0"	110.4	4.215	.120
S/M 6004G	4" x 20'	04012	1340'	20'-0"	109.7	4.215	.120
S/M 6006G	6" x 14'	11921	462'	14'-0"	249.6	6.275	.180
S/M 6006G	6" x 20'	04016	660'	20'-0"	247.0	6.275	.180
S/M 6008G	8" x 14'	11922	140'	14'-0"	451.0	8.400	.240

Weight is approximate and is for shipping purposes only.

SDR-35		SOLVENT WELD - PS 46					
PART NO.	NOM. SIZE	UPC # 611942-	QTY. PER SKID	LAYING LENGTH	WT. PER 100 FT. (LBS.)	AVG. OD (IN.)	MIN. WALL (IN.)
S/M 6004	4" x 10'	04008	670'	10'-0"	108.3	4.215	.120
S/M 6004	4" x 20'	04009	1340'	20'-0"	108.3	4.215	.120
S/M 6006	6" x 10'	04013	330'	10'-0"	241.7	6.275	.180
S/M 6006	6" x 20'	04014	660'	20'-0"	241.7	6.275	.180

Weight is approximate and is for shipping purposes only.

NOTE: For truckloads of mixed sizes, multiply skids desired by truckload percent per skid.

Meets All Requirements of ASTM D 3034.

SDR 35 Gaskets meet or exceed ASTM F 477.

Gasketed joints meet ASTM D 3212.

## NOTICE

### NOT FOR PRESSURE

Do not use PVC Sewer pipe for pressure applications. The use of sewer pipe in pressure applications may result in system failure and property damage.

## WARNING

Testing with or use of compressed air or gas in ABS / CPVC / PVC pipe or fittings can result in explosive failures and cause severe injury or death.

AIR/GAS



- NEVER test with or transport/store compressed air or gas in ABS / CPVC / PVC pipe or fittings.
- NEVER test ABS / CPVC / PVC pipe or fittings with compressed air or gas, or air over water boosters.
- ONLY use ABS / CPVC / PVC pipe or fittings for water or approved chemicals.
- Refer to warnings on PPFA's website and ASTM D 1785.

# PVC Sewer and Drain Pipe

## >> PVC ASTM D 2729 Pipe

SOLVENT WELD BELLED END						ASTM D 2729	
PART NO.	NOM. SIZE	UPC # 611942-	QTY. PER SKID	AVG. OD (IN.)	MIN. WALL (IN.)	BELL DEPTH (IN.)	WT. PER 100 FT. (LBS.)
PVC 30030	3" x 10'	10903	810'	3.250	0.070	3.00	52.8
PVC 30040	4" x 10'	10905	500'	4.215	0.075	3.50	70.4
PVC 30060	6" x 10'	15149	330'	6.275	0.100	4.00	129.0

## >> Perforated PVC ASTM D 2729 Pipe

SOLVENT WELD BELLED END						ASTM D 2729	
PART NO.	NOM. SIZE	UPC # 611942-	QTY. PER SKID	AVG. OD (IN.)	MIN. WALL (IN.)	BELL DEPTH (IN.)	WT. PER 100 FT. (LBS.)
PVC 30030P	3" x 10'	11814	1040'	3.250	0.070	3.00	52.8
PVC 30040P	4" x 10'	11815	500'	4.215	0.075	3.50	70.4

Perforated pipe is supplied with two rows of 1/2" diameter holes every five inches. Rows are parallel to the pipe axis and are 120° apart.

Weight is approximate and is for shipping purposes only.

NOTE: For truckloads of mixed sizes, multiply skids desired by truckload percent per skid.

Pipe listed in this section meets or exceeds the requirements of ASTM D 2729.

Perforation Detail  
2-Hole 120 Degree

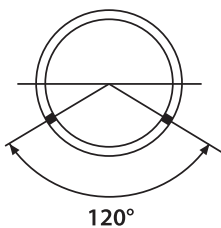

## NOTICE

**NOT FOR PRESSURE**

Do not use PVC Sewer pipe for pressure applications. The use of sewer pipe in pressure applications may result in system failure and property damage.

## ⚠ WARNING

Testing with or use of compressed air or gas in ABS / CPVC / PVC pipe or fittings can result in explosive failures and cause severe injury or death.

- NEVER test with or transport/store compressed air or gas in ABS / CPVC / PVC pipe or fittings.
- NEVER test ABS / CPVC / PVC pipe or fittings with compressed air or gas, or air over water boosters.
- ONLY use ABS / CPVC / PVC pipe or fittings for water or approved chemicals.
- Refer to warnings on PPFA's website and ASTM D 1785.

AIR/GAS

The illustration shows a person standing next to a pipe. An arrow labeled 'AIR/GAS' points down into the pipe. A pipe fragment is shown flying through the air, striking the person's head. The person is depicted falling backwards, indicating a severe injury.

## Materials for Pressurized Systems

### Typical Pressure Applications:

- Distribute potable (drinking) water up to a building
- Distribute potable (drinking) water inside a building (CPVC only)
- Irrigation/sprinkler systems
- Drain condensate from HVAC systems

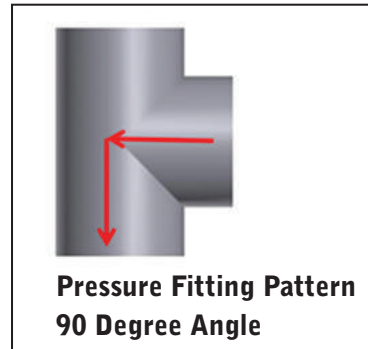

### FlowGuard Gold® CPVC CTS Pipe and Fittings

- Manufactured from chlorinated polyvinyl chloride
- Use for hot and cold water
- Cream or tan in color
- Copper Tube Size

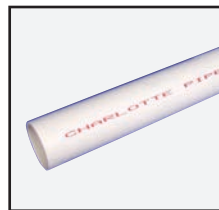

### PVC SDR 21 and SDR 26 Pipe

- Manufactured from polyvinyl chloride
- Standard Dimensional Ratio (SDR) Pipe
- White in color



### PVC Schedule 40 Pipe and Fittings

- Manufactured from polyvinyl chloride
- White in color
- Pressure ratings vary by size and type of fitting



### CPVC Schedule 80 Pipe and Fittings\*

- Manufactured from chlorinated polyvinyl chloride
- Light gray in color
- This product not currently available for sale in the United States

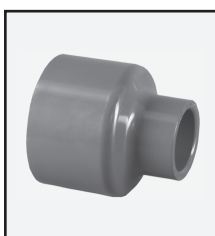

### PVC Schedule 80 Pipe and Fittings

- Manufactured from polyvinyl chloride
- Dark gray in color
- Thicker wall than Schedule 40

## ⚠ WARNING

Testing with or use of compressed air or gas in ABS / CPVC / PVC pipe or fittings can result in explosive failures and cause severe injury or death.

AIR/GAS

- NEVER test with or transport/store compressed air or gas in ABS / CPVC / PVC pipe or fittings.
- NEVER test ABS / CPVC / PVC pipe or fittings with compressed air or gas, or air over water boosters.
- ONLY use ABS / CPVC / PVC pipe or fittings for water or approved chemicals.
- Refer to warnings on PPSA's website and ASTM D 1785.

\* Note: This product is not currently available for sale in the United States. Information provided is for reference only.



# PVC Pipe: Schedule 40



## >> PVC Schedule 40 Pipe, Type 1, Grade 1 - Plain End

PVC SCHEDULE 40 (WHITE)		PLAIN END		PVC 1120	ASTM D 1785	
PART NO.	NOM. SIZE	UPC # 611942-	AVG. OD (IN.)	MIN. WALL (IN.)	MAX WORK PRESSURE AT 23° C OR 73° F	WT. PER 100 FT. (LBS.)
PVC 4005	½" x 10'	06658	.840	.109	600 PSI	15.9
PVC 4005	½" x 20'	03922	.840	.109	600 PSI	15.9
PVC 4007	¾" x 10'	06661	1.050	.113	480 PSI	21.1
PVC 4007	¾" x 20'	03925	1.050	.113	480 PSI	21.1
PVC 4010	1" x 10'	06664	1.315	.133	450 PSI	31.3
PVC 4010	1" x 20'	03928	1.315	.133	450 PSI	31.3
PVC 7100*	1¼" x 10'	03945	1.660	.140	370 PSI	42.4
PVC 7100*	1¼" x 20'	03946	1.660	.140	370 PSI	42.4
PVC 7112*	1½" x 10'	03947	1.900	.145	330 PSI	51.8
PVC 7112*	1½" x 20'	03948	1.900	.145	330 PSI	51.8
PVC 7200*	2" x 10'	03949	2.375	.154	280 PSI	69.5
PVC 7200*	2" x 20'	03950	2.375	.154	280 PSI	69.5
PVC 4025‡	2½" x 20'	04205	2.875	.203	300 PSI	110.0
PVC 7300*	3" x 10'	03951	3.500	.216	260 PSI	144.2
PVC 7300*	3" x 20'	03952	3.500	.216	260 PSI	144.2
PVC 7400†	4" x 10'	03953	4.500	.237	220 PSI	205.5
PVC 7400†	4" x 20'	03954	4.500	.237	220 PSI	205.5
PVC 7500†	5" x 20'	04837	5.563	.258	190 PSI	272.5
PVC 7600†	6" x 10'	03955	6.625	.280	180 PSI	361.2
PVC 7600†	6" x 20'	03956	6.625	.280	180 PSI	361.2
PVC 7800†	8" x 10'	13087	8.625	.322	160 PSI	543.6
PVC 7800†	8" x 20'	03958	8.625	.322	160 PSI	543.6
PVC 7910†	10" x 20'	03959	10.750	.365	140 PSI	770.7
PVC 7912†	12" x 20'	03961	12.750	.406	130 PSI	1019.0
PVC 7914†	14" x 20'	04862	14.000	.437	130 PSI	1205.0
PVC 7916†	16" x 20'	04918	16.000	.500	130 PSI	1575.7

\* Dual Marked ASTM D 1785 and ASTM D 2665.

† Triple Marked ASTM D 1785 & ASTM D 2665 & ASTM F 480.

‡ Dual Marked ASTM D 1785 & ASTM F 480.

NOTE: When ordering, please specify plain end or bell end.

NSF Listed. Meets All Requirements of ASTM D 1784 and ASTM D 1785.

**WARNING**

Testing with or use of compressed air or gas in ABS / CPVC / PVC pipe or fittings can result in explosive failures and cause severe injury or death.

AIR/GAS

- NEVER test with or transport/store compressed air or gas in ABS / CPVC / PVC pipe or fittings.
- NEVER test ABS / CPVC / PVC pipe or fittings with compressed air or gas, or air over water boosters.
- ONLY use ABS / CPVC / PVC pipe or fittings for water or approved chemicals.
- Refer to warnings on PPFA's website and ASTM D 1785.

# PRODUCT DATA

## >> PVC Schedule 40 Pipe, Type 1, Grade 1 - Bell End\*

PVC SCHEDULE 40 (WHITE)			BELL END		PVC 1120	ASTM D 1785	
PART NO.	NOM. SIZE	UPC # 611942-	AVG. OD (IN.)	MIN. WALL (IN.)	MAX WORK PRESSURE AT 23° C OR 73° F	BELL DEPTH (IN.)	WT. PER 100 FT. (LBS.)
PVC 4005B**	½" x 10'	04986	.840	.109	600 PSI	2.00	15.9
PVC 4005B**	½" x 20'	03923	.840	.109	600 PSI	2.00	15.9
PVC 4007B**	¾" x 10'	04987	1.050	.113	480 PSI	2.25	21.1
PVC 4007B**	¾" x 20'	03926	1.050	.113	480 PSI	2.25	21.1
PVC 4010B**	1" x 10'	04988	1.315	.133	450 PSI	2.50	31.3
PVC 4010B**	1" x 20'	03929	1.315	.133	450 PSI	2.50	31.3
PVC 4012B§	1¼" x 10'	04989	1.660	.140	370 PSI	2.75	42.4
PVC 4012B§	1¼" x 20'	03930	1.660	.140	370 PSI	2.75	42.4
PVC 4015B§	1½" x 10'	04990	1.900	.145	330 PSI	3.00	51.8
PVC 4015B§	1½" x 20'	03931	1.900	.145	330 PSI	3.00	51.8
PVC 4020B†	2" x 10'	04991	2.375	.154	280 PSI	4.00	69.5
PVC 4020B†	2" x 20'	03932	2.375	.154	280 PSI	4.00	69.5
PVC 4025B‡	2½" x 20'	04206	2.875	.203	300 PSI	4.00	110.0
PVC 7300B§	3" x 10'	04853	3.500	.216	260 PSI	4.00	147.6
PVC 4030B†	3" x 20'	03933	3.500	.216	260 PSI	4.00	144.2
PVC 7400B§	4" x 10'	04835	4.500	.237	220 PSI	4.00	212.3
PVC 9400B†	4" x 20'	03964	4.500	.237	220 PSI	5.00	210.6
PVC 7600B§	6" x 10'	04850	6.625	.280	180 PSI	6.50	379.3
PVC 9600B†	6" x 20'	03965	6.625	.280	180 PSI	6.50	373.2
PVC 7800B†	8" x 10'	09903	8.625	.322	160 PSI	7.00	556.9
PVC 9800B†	8" x 20'	03967	8.625	.322	160 PSI	7.00	564.0
PVC 7910B†	10" x 20'	03960	10.750	.365	140 PSI	9.00	781.4
PVC 7912B†	12" x 20'	03962	12.750	.406	130 PSI	10.00	1033.2
PVC 7914B†	14" x 20'	04863	14.000	.437	130 PSI	10.00	1221.8
PVC 7916B†	16" x 20'	04929	16.000	.500	130 PSI	10.00	1594.5

\* Bell dimensions meet either ASTM D 2672 or ASTM F 480, depending upon pipe diameter

\*\* ASTM D 1785

§ Dual Marked ASTM D 1785 & ASTM D 2665

† Triple Marked ASTM D 1785 & ASTM D 2665 & ASTM F 480

‡ Dual Marked ASTM D 1785 & ASTM F 480

WARNING

**Testing with or use of compressed air or gas in ABS / CPVC / PVC pipe or fittings can result in explosive failures and cause severe injury or death.**

AIR/GAS

- NEVER test with or transport/store compressed air or gas in ABS / CPVC / PVC pipe or fittings.
- NEVER test ABS / CPVC / PVC pipe or fittings with compressed air or gas, or air over water boosters.
- ONLY use ABS / CPVC / PVC pipe or fittings for water or approved chemicals.
- Refer to warnings on PPFA's website and ASTM D 1785.

# PRODUCT DATA

## >> PVC Well Casing, Type 1, Grade 1

PVC SCHEDULE 40 (WHITE)		BELL END WELL CASING			PVC 1120	ASTM F 480
PART NO.	NOM. SIZE	UPC # 611942-	AVG. OD (IN.)	MIN. WALL (IN.)	BELL DEPTH (IN.)	WT. PER 100 FT. (LBS.)
PVC 4020B	2"X20'	03932	2.375	.154	4.00	69.5
PVC 4025B	2½"X20'	04206	2.875	.203	4.00	110.0
PVC 4030B	3"X20'	03933	3.500	.216	4.00	144.2
PVC 9400B	4"X20'	03964	4.500	.237	5.00	210.6
PVC 9600B	6"X20'	03965	6.625	.280	6.50	373.2
PVC 9800B	8"X20'	03967	8.625	.322	7.00	564.0
PVC 7910B	10"X20'	03960	10.750	.365	9.00	781.4
PVC 7912B	12"X20'	03962	12.750	.406	10.00	1033.2
PVC 7914B	14"X20'	04863	14.000	.437	10.00	1221.8
PVC 7916B	16"X20'	04929	16.000	.500	10.00	1594.5

## >> PVC SDR Pipe

PR 200	PVC 1120	BELL END			ASTM D 2241	SDR 21	
PART NO.	NOM. SIZE	UPC # 611942-	AVG. OD (IN.)	MIN. WALL (IN.)	MAX WORK PRESSURE AT 23° C OR 73° F	BELL DEPTH (IN.)	WT. PER 100 FT. (LBS.)
PVC 23155B	*1½" x 20'	03991	.840	.062	315 PSI	2.00	10.0
PVC 20007B	¾" x 10'	10742	1.050	.060	200 PSI	2.25	11.8
PVC 20007B	¾" x 20'	03984	1.050	.060	200 PSI	2.25	11.8
PVC 20010B	1" x 20'	03986	1.315	.063	200 PSI	2.50	15.7
PVC 20012B	1¼" x 20'	03987	1.660	.079	200 PSI	2.75	25.5
PVC 20015B	1½" x 20'	03988	1.900	.090	200 PSI	3.00	32.4
PVC 20020B	2" x 20'	03989	2.375	.113	200 PSI	4.00	50.8
PVC 20025B	2½" x 20'	12976	2.875	.137	200 PSI	4.00	75.7
PVC 20030B	3" x 20'	12977	3.500	.167	200 PSI	4.00	112.4
PVC 20040B	4" x 20'	12978	4.500	.214	200 PSI	4.00	185.2
PVC 20060B	6" x 20'	12979	6.625	.316	200 PSI	6.00	402.6

\*PR 315 / SDR 13.5

PR 160	PVC 1120	BELL END			ASTM D 2241	SDR 26	
PART NO.	NOM. SIZE	UPC # 611942-	AVG. OD (IN.)	MIN. WALL (IN.)	MAX WORK PRESSURE AT 23° C OR 73° F	BELL DEPTH (IN.)	WT. PER 100 FT. (LBS.)
PVC 16012B	1¼" x 20'	04211	1.660	.064	160 PSI	2.75	21.5
PVC 16015B	1½" x 20'	04210	1.900	.073	160 PSI	3.00	26.6
PVC 16020B	2" x 20'	04212	2.375	.091	160 PSI	4.00	41.4
PVC 16025B	2½" x 20'	12980	2.875	.110	160 PSI	4.00	61.4
PVC 16030B	3" x 20'	04222	3.500	.135	160 PSI	4.00	90.8
PVC 16040B	4" x 20'	12981	4.500	.173	160 PSI	4.00	149.8
PVC 16060B	6" x 20'	12982	6.625	.255	160 PSI	4.00	325.0



# PVC Schedule 80 Pipe



## >> PVC Schedule 80 Pipe, Type 1, Grade 1 - Plain End

ASTM D 1784 & ASTM D 1785

PVC SCHEDULE 80 (GRAY)			PLAIN END			PVC 1120
PART NO.	NOM. SIZE	UPC # 611942-	AVG. OD (IN.)	MIN. WALL (IN.)	MAX WORK PRESSURE AT 23° C OR 73° F	WT. PER 100 FT. (LBS.)
PVC 10002	¼" x 20'	04920	0.540	.119	1130 PSI	10.0
PVC 10003	⅜" x 20'	04917	0.675	.126	920 PSI	13.8
PVC 10005	½" x 20'	03968	0.840	.147	850 PSI	20.3
PVC 10007	¾" x 20'	03969	1.050	.154	690 PSI	27.5
PVC 10010	1" x 20'	03970	1.315	.179	630 PSI	40.5
PVC 10012	1¼" x 20'	03973	1.660	.191	520 PSI	55.9
PVC 10015	1½" x 20'	03976	1.900	.200	470 PSI	67.7
PVC 10020	2" x 20'	03977	2.375	.218	400 PSI	93.6
PVC 10025	2½" x 20'	03978	2.875	.276	420 PSI	142.8
PVC 10030	3" x 20'	03979	3.500	.300	370 PSI	194.2
PVC 10040	4" x 20'	03980	4.500	.337	320 PSI	279.3
PVC 10050	5" x 20'	04831	5.563	.375	290 PSI	387.3
PVC 10060	6" x 20'	03981	6.625	.432	280 PSI	532.7
PVC 10080	8" x 20'	04175	8.625	.500	250 PSI	808.9
PVC 10100	10" x 20'	04768	10.750	.593	230 PSI	1199.3
PVC 10120	12" x 20'	04770	12.750	.687	230 PSI	1650.1
PVC 10140	14" x 20'	04816	14.000	.750	220 PSI	1930.0
PVC 10160	16" x 20'	04919	16.000	.843	220 PSI	2544.1

NSF Listed. Meets All Requirements of ASTM D 1784 and ASTM D 1785.

**WARNING**

Testing with or use of compressed air or gas in ABS / CPVC / PVC pipe or fittings can result in explosive failures and cause severe injury or death.

AIR/GAS

- NEVER test with or transport/store compressed air or gas in ABS / CPVC / PVC pipe or fittings.
- NEVER test ABS / CPVC / PVC pipe or fittings with compressed air or gas, or air over water boosters.
- ONLY use ABS / CPVC / PVC pipe or fittings for water or approved chemicals.
- Refer to warnings on PPFA's website and ASTM D 1785.

# PVC Schedule 80 Pipe



## >> PVC Schedule 80 Pipe, Type 1, Grade 1 - Belled End

ASTM D 1784 & ASTM D 1785

PVC SCHEDULE 80 (GRAY)			BELLED-END			PVC 1120
PART NO.	NOM. SIZE	UPC # 611942-	AVG. OD (IN.)	MIN. WALL (IN.)	MAX WORK PRESSURE AT 23° C OR 73° F	WT. PER 100 FT. (LBS.)
PVC 10005B	½" x 20'	04924	0.840	.147	850 PSI	20.3
PVC 10007B	¾" x 20'	04925	1.050	.154	690 PSI	27.0
PVC 10010B	1" x 20'	04926	1.315	.179	630 PSI	40.5
PVC 10012B	1¼" x 20'	04927	1.660	.191	520 PSI	55.9
PVC 10015B	1½" x 20'	04928	1.900	.200	470 PSI	67.7
PVC 10020B	2" x 20'	04764	2.375	.218	400 PSI	93.6
PVC 10025B	2½" x 20'	04875	2.875	.276	420 PSI	142.8
PVC 10030B	3" x 20'	04776	3.500	.300	370 PSI	191.1
PVC 10040B	4" x 20'	04774	4.500	.337	320 PSI	279.3
PVC 10060B	6" x 20'	04763	6.625	.432	280 PSI	532.7
PVC 10080B	8" x 20'	04766	8.625	.500	250 PSI	808.9
PVC 10100B	10" x 20'	04769	10.750	.593	230 PSI	1199.3
PVC 10120B	12" x 20'	04771	12.750	.687	230 PSI	1650.1
PVC 10140B	14" x 20'	04832	14.000	.750	220 PSI	1930.0
PVC 10160B	16" x 20'	09372	16.000	.843	220 PSI	2544.1

NSF Listed. Meets All Requirements of ASTM D 1784 and ASTM D 1785.

**⚠ WARNING**

Testing with or use of compressed air or gas in ABS / CPVC / PVC pipe or fittings can result in explosive failures and cause severe injury or death.

AIR/GAS

- NEVER test with or transport/store compressed air or gas in ABS / CPVC / PVC pipe or fittings.
- NEVER test ABS / CPVC / PVC pipe or fittings with compressed air or gas, or air over water boosters.
- ONLY use ABS / CPVC / PVC pipe or fittings for water or approved chemicals.
- Refer to warnings on PPFA's website and ASTM D 1785.

# CPVC Schedule 80 Pipe\*



>> \* © Corzan CPVC Schedule 80 Pipe, Type IV, Grade 1

ASTM D 1784 & ASTM F 441

CPVC SCHEDULE 80 (LIGHT GRAY)			PLAIN END		CPVC 4120	
PART NO.	NOM. SIZE	UPC # 611942-	AVG. OD (IN.)	MIN. WALL (IN.)	MAX WORK PRESSURE AT 23° C OR 73° F	WT. PER 100 FT. (LBS.)
CPV 11005	½" x 19'	13088	.840	.147	850 PSI	22.1
CPV 11007	¾" x 19'	13089	1.050	.154	690 PSI	30.0
CPV 11010	1" x 19'	13090	1.315	.179	630 PSI	44.2
CPV 11012	1¼" x 19'	13091	1.660	.191	520 PSI	61.0
CPV 11015	1½" x 19'	13092	1.900	.200	470 PSI	73.9
CPV 11020	2" x 19'	13093	2.375	.218	400 PSI	102.2
CPV 11025	2½" x 19'	13094	2.875	.276	420 PSI	155.9
CPV 11030	3" x 19'	13095	3.500	.300	370 PSI	208.6
CPV 11040	4" x 19'	13096	4.500	.337	320 PSI	304.9
CPV 11060	6" x 19'	13097	6.625	.432	280 PSI	581.5
CPV 11080	8" x 19'	14138	8.625	.500	250 PSI	882.9

\* Note: This product is not currently available for sale in the United States. Information provided is for reference only.

NSF Listed. Meets All Requirements of ASTM D 1784 and ASTM F 441.

Corzan is a registered trademark of Lubrizol Corp.

**WARNING**

Testing with or use of compressed air or gas in ABS / CPVC / PVC pipe or fittings can result in explosive failures and cause severe injury or death.

AIR/GAS

- NEVER test with or transport/store compressed air or gas in ABS / CPVC / PVC pipe or fittings.
- NEVER test ABS / CPVC / PVC pipe or fittings with compressed air or gas, or air over water boosters.
- ONLY use ABS / CPVC / PVC pipe or fittings for water or approved chemicals.
- Refer to warnings on PPFA's website and ASTM D 1785.



## Socket Dimensions For Belled-End Pipe

NOM. Pipe size	ASTM Standard	SOCKET ENTRANCE (A)		SOCKET BOTTOM (B)		SOCKET LENGTH (C)		
		I.D. Min.	I.D. Max.	I.D. Min.	I.D. Max.	SDR	Schedule 40	Schedule 80
½	D 2672	.844	0.852	0.832	0.840	2.000	2.000	1.000
¾	D 2672	1.054	1.062	1.042	1.050	2.250	2.250	1.250
1	D 2672	1.320	1.330	1.305	1.315	2.500	2.500	1.500
1¼	D 2672	1.665	1.675	1.650	1.660	2.750	2.750	1.750
1½	D 2672	1.906	1.918	1.888	1.900	3.000	3.000	2.000
2	D 2672	2.381	2.393	2.357	2.369	4.000	—	2.250
2	F 480	2.380	2.392	2.357	2.369	—	4.000	—
2½	D 2672	2.882	2.896	2.854	2.868	4.000	—	2.500
2½	F 480	2.880	2.894	2.854	2.868	—	4.000	—
3	D 2672	3.508	3.524	3.476	3.492	4.000	—	3.250
3	F 480	3.506	3.522	3.476	3.492	—	4.000	—
4	D 2672	4.509	4.527	4.473	4.491	5.000	—	4.000
4	F 480	4.508	4.526	4.473	4.491	—	5.000	—
6	D 2672	6.636	6.658	6.592	6.614	6.500	—	6.000
6	F 480	6.637	6.659	6.592	6.614	—	6.500	—
8	D 2672	8.640	8.670	8.583	8.613	—	—	6.000
8	F 480	8.634	8.664	8.583	8.613	—	7.000	—
10	D 2672	10.761	10.791	10.707	10.737	—	9.000	7.500
12	D 2672	12.763	12.793	12.706	12.736	—	10.000	8.500
14	D 2672	14.020	14.050	13.970	14.000	—	10.000	9.000
16	D 2672	16.030	16.060	15.965	15.995	—	10.000	10.000

Note: All dimensions are in inches.

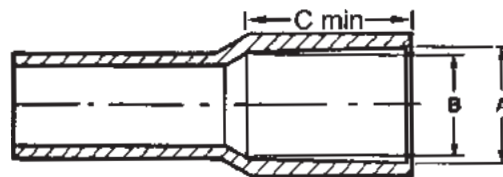

# FlowGuard Gold<sup>®</sup> Pipe

## >> CPVC Copper Tube Size Pipe



STRAIGHT LENGTHS			PLAIN END SDR 11 CPVC COPPER TUBE SIZE PIPE				ASTM D 2846	
PART NO.	NOM. SIZE	UPC # 611942-	QTY. PER BUNDLE	QTY. PER SKID	AVG. OD (IN.)	MIN. WALL (IN.)	MAX WORK PRESSURE AT 23° C OR 73° F	WT. PER 100 FT. (LBS.)
CTS 12005	½" x 10'	04979	500'	12,000'	.625	.068	400 PSI	8.3
CTS 12005	½" x 20'	04993	1,000'	24,000'	.625	.068	400 PSI	8.3
CTS 12007	¾" x 10'	04980	250'	6,000'	.875	.080	400 PSI	13.9
CTS 12007	¾" x 20'	05145	500'	12,000'	.875	.080	400 PSI	13.9
CTS 12010	1" x 10'	05146	150'	3,600'	1.125	.102	400 PSI	22.2
CTS 12010	1" x 20'	05147	300'	7,200'	1.125	.102	400 PSI	22.2
CTS 12012	1¼" x 10'	05148	100'	2,400'	1.375	.125	400 PSI	33.3
CTS 12012	1¼" x 20'	05321	200'	4,800'	1.375	.125	400 PSI	33.3
CTS 12015	1½" x 10'	05150	60'	1,440'	1.625	.148	400 PSI	46.6
CTS 12015	1½" x 20'	05306	120'	2,880'	1.625	.148	400 PSI	46.6
CTS 12020	2" x 10'	05152	40'	960'	2.125	.193	400 PSI	79.5
CTS 12020	2" x 20'	05322	80'	1,920'	2.125	.193	400 PSI	79.5

NOTE: STRAIGHT LENGTH PIPE ARE SHIPPED IN FULL BUNDLE QUANTITY ONLY.

COILED PIPE SDR 11			COILED SDR CPVC COPPER TUBE SIZE PIPE				ASTM D 2846	
PART NO.	NOM. SIZE	UPC # 611942-	QTY. PER BUNDLE	QTY. PER SKID	AVG. OD (IN.)	MIN. WALL (IN.)	MAX WORK PRESSURE AT 23° C OR 73° F	WT. PER 100 FT. (LBS.)
CTS 12005	½" x 150'	05313	150'	3,750'	.625	.068	400 PSI	8.3
CTS 12007	¾" x 100'	05314	100'	2,500'	.875	.080	400 PSI	13.9
CTS 12010	1" x 100'	10643	100'	1,200'	1.125	.102	400 PSI	22.2

NSF Listed. Meets All Requirements of ASTM D 2846.

NOTE: Please call Charlotte Pipe at 800/438-6091 or visit our website [www.CharlottePipe.com](http://www.CharlottePipe.com) for the latest CPVC Chemical Compatibility Sheet.

**WARNING**

Testing with or use of compressed air or gas in ABS / CPVC / PVC pipe or fittings can result in explosive failures and cause severe injury or death.

- NEVER test with or transport/store compressed air or gas in ABS / CPVC / PVC pipe or fittings.
- NEVER test ABS / CPVC / PVC pipe or fittings with compressed air or gas, or air over water boosters.
- ONLY use ABS / CPVC / PVC pipe or fittings for water or approved chemicals.
- Refer to warnings on PFFA's website and ASTM D 1785.

AIR/GAS

## Pressure/Temperature Relationship

### Maximum Operating Temperatures For Various Piping Systems (de-rate operating pressure at temperatures in excess of 73°F)

Piping System	Max. Operating Temp. °F
ABS	140
PVC	140
CPVC - FlowGuard Gold® CTS	180
CPVC - Corzan® Sch. 80	200
CPVC - ChemDrain®*	220

\* See the ChemDrain Technical Manual for more information on this product.

**NOTICE:** The maximum recommended temperature and de-rating of working pressure applies to both heat generated from fluid being distributed through pipe system and heat generated from sources external to the pipe system.

### Temperature De-Rating For Schedule 40 & 80 PVC & CPVC

The operating pressure of PVC and CPVC pipe will be reduced as the operating temperature increases above 73° F. To calculate this reduction, multiply the operating pressures shown on the previous pages by the correction factors shown below:

Operating Temperature (°F)	Correction Factors	
	PVC	CPVC
73	1.00	1.00
80	.88	1.00
90	.75	.91
100	.62	.82
110	.50	.77
120	.40	.65
130	.30	.62
140	.22	.50
150	NR	.47
160	NR	.40
170	NR	.32
180	NR	.25
200	NR	.20

For example, the operating pressure for 6" Schedule 80 PVC pipe is 280 psi. If the operating temperature is 140° F, the maximum operating pressure is now 62 psi (280 x .22).

## Pressure Rating of Fittings, Flanges, and Unions

### Pressure Rating PVC Schedule 40 and PVC Schedule 80

One of the more complex questions in the plastic pipe and fittings industry is associated with the pressure rating of fittings used in PVC Schedule 40 and PVC Schedule 80 systems. While these fittings are used in pressure systems, strictly speaking, they are not pressure rated.

There has been an effort underway at ASTM International for many years to solve this question. However, the industry has not been able to develop a methodology for pressure rating fittings due to their varied configurations. The best effort to date is found within ASTM F 2261 *Standard Test Method for Pressure Rating PVC Plastic Pipe Fittings, Schedule 40 and 80 Socket Type*. This test method is similar to that found within ASTM D 2837 which is used to determine the Hydrostatic Design Basis (HDB) of plastic pipe. However, plastic pipe has a uniform shape that reacts consistently to pressure and fittings do not.

ASTM F 2261 indicates:

1.2 Unless the data (for fitting failure tests) approximates a straight line, when calculated using log-log coordinates, it is not possible to assign a pressure rating to that product or sample product. ... where the lower confidence level limits are not met the data shall be classified as unsuitable.

Unfortunately, logged fitting failure test data is typically dispersed and judged as unsuitable.

The 1987 publication *Designing, Operating and Maintaining Piping Systems Using PVC Fittings* by Ron D. Bliesner is a respected reference addressing the pressure rating of fittings. This publication establishes a rule of thumb indicating that the working pressure for fittings is 60% of the working pressure of pipe. Charlotte Pipe agrees with this rule of thumb and recommends that the maximum working pressure for PVC Schedule 40 and PVC Schedule 80 fittings is 60% of the maximum working pressure of pipe of the same diameter and schedule. As with pipe, the maximum working pressure must be de-rated at temperatures exceeding 73 degrees F.

Special engineered fittings such as flanges, unions, or valves differ in that they carry a pressure rating specified by the manufacturer which is usually lower than that of pipe of the same diameter.

### De-rating Threaded Fittings, Valves and Unions

Pressure ratings shown are for socket (solvent cement) systems. The system must always be de-rated to the pressure rating of the lowest rated system component at the expected maximum system operating temperature.

- For pressure ratings of flanges or unions, see flanges and unions in the installation procedures section of this manual.
- Pressure ratings of Sch. 40 and Sch. 80 molded or cut threads are 50% of solvent cement systems. Please see table in the Threaded Joints and Threading of PVC and CPVC Pipe section of this manual.
- For pressure ratings of valves or other system components, always consult the technical recommendations from the manufacturers of those products.

## NOTICE

**Do not exceed the maximum working pressure of any system components including pipe, fittings, valves, molded or cut threads, unions, mechanical coupling or flanges.**

- The pressure rating of all components must be reduced at temperatures above 73 degrees F. Refer to de-rating table in this manual.
- Exceeding the maximum working temperature or pressure of the system may result in system failure and property damage.

## NOTICE

**Use of FlowGuard Gold® CTS CPVC all-plastic threaded male adapters in hot water applications may result in system failure and property damage.**

- Use plastic threaded CTS CPVC male adapters in cold water applications only.
- Use CTS CPVC x brass threaded transition fittings for hot water applications.
- Do not use compression fittings with brass ferrules to connect to CTS CPVC pipe or fittings where water temperatures will exceed 140 degrees F.
- CPVC pipe can be used with standard brass ferrules to make compression connections where the operating temperature will not exceed 140°F. Apply Teflon (PTFE) tape over the ferrule to allow for the dissimilar thermal expansion and contraction characteristics of the metal ferrule and the plastic pipe.

## PVC Schedule 40 Pressure Ratings

Size	Pressure Rating (psi) @ 73°F					Pressure Rating (psi) @ 140°F				
	Pipe	Socket Fittings	Threaded Fittings	Flanges	Unions	Pipe	Socket Fittings	Threaded Fittings	Flanges	Unions
½"	600	360	300	150	235	132	79	66	33	52
¾"	480	288	240	150	235	106	63	53	33	52
1"	450	270	225	150	235	99	59	50	33	52
1¼"	370	222	185	150	235	81	49	41	33	52
1½"	330	198	165	150	235	73	44	36	33	52
2"	280	168	140	150	235	62	37	31	33	52
2½"	300	180	150	150	-	66	40	33	33	-
3"	260	156	130	150	235	57	34	29	33	52
4"	220	132	110	150	-	48	29	24	33	-
5"	190	114	95	-	-	42	25	21	-	-
6"	180	108	90	150	-	40	24	20	33	-
8"	160	96	80	150	-	35	21	18	33	-
10"	140	84	70	150	-	31	18	15	33	-
12"	130	78	65	150	-	29	17	14	33	-
14"	130	78	65	-	-	29	17	14	-	-
16"	130	78	65	-	-	29	17	14	-	-

## PVC Schedule 80 Pressure Ratings

Size	Pressure Rating (psi) @ 73° F						Pressure Rating (psi) @ 140° F					
	Pipe	Socket Fittings	Threaded Fittings	Flanges	Unions (Socket)	Unions (Threaded)	Pipe	Socket Fittings	Threaded Fittings	Flanges	Unions (Socket)	Unions (Threaded)
½"	850	510	425	150	235	235	187	112	94	33	52	52
¾"	690	414	345	150	235	235	152	91	76	33	52	52
1"	630	378	315	150	235	235	139	83	69	33	52	52
1¼"	520	312	260	150	235	235	114	69	57	33	52	52
1½"	470	282	235	150	235	235	103	62	52	33	52	52
2"	400	240	200	150	235	200	88	53	44	33	52	44
2½"	420	252	210	150	-	-	92	55	46	33	-	-
3"	370	222	185	150	235	185	81	49	41	33	52	41
4"	320	192	160	150	-	-	70	42	35	33	-	-
5"	290	174	145	-	-	-	64	38	32	-	-	-
6"	280	168	140	150	-	-	62	37	31	33	-	-
8"	250	150	125	150	-	-	55	33	28	33	-	-
10"	230	138	115	150	-	-	51	30	25	33	-	-
12"	230	138	115	150	-	-	51	30	25	33	-	-
14"	220	132	110	-	-	-	48	29	24	-	-	-
16"	220	132	110	-	-	-	48	29	24	-	-	-

## NOTICE

Do not exceed the maximum working pressure of any system components including pipe, fittings, valves, molded or cut threads, unions, mechanical coupling or flanges.

- The pressure rating of all components must be reduced at temperatures above 73 degrees F. Refer to de-rating table in this manual.
- Exceeding the maximum working temperature or pressure of the system may result in system failure and property damage.

## Important Information on Threaded Connections

Millions of PVC, ABS and CPVC threaded fittings have been produced over the years. When properly installed these fittings provide excellent service in both pressure and drainage applications. Some of the most common installation errors include over-tightening and the inappropriate use of female adapters.

### Tapered Threads

American National Standard B2.1 is the dominant standard used for threaded fittings in piping applications. Adherence to this standard ensures that mating parts will thread properly and provide appropriate service. ANS B2.1 requires that fittings be made with tapered threads. Fittings with tapered threads work like a wedge; the wedge forming the water seal like a cork in a bottle and the threads holding the two parts together. However, this wedge also exerts tremendous force which can crack female fittings just as a small wedge tapped into a hole can be used to split giant boulders in a quarry.



In piping applications the force generated when a tapered fitting (wedge) is tightened is referred to as strain. If a threaded fitting is over-tightened, the strength of the plastic material can be exceeded, causing the material to yield and the fitting to fail.

Strain increases as the pipe diameter decreases, making it easier to split smaller-diameter threaded fittings than larger fittings. At the same time, it is easier for an installer to over-tighten small diameter fittings because less effort is required to tighten them.

### Threaded Fitting Applications

Threaded plastic pipe and fittings fall into two categories of application. The first is when they are used in all-plastic systems. The second is when they are used to transition from metal to plastic. There are three possible combinations: 1) plastic male to plastic female (recommended); 2) plastic male to metal female (recommended for cold water applications only); 3) metal male to plastic female (not recommended). Threading metal male thread into a plastic female thread produces very high stress in the plastic fitting and is not recommended by Charlotte Pipe. For reasons cited above, the Uniform Plumbing Code expressly prohibits the use of CTS CPVC female adapters.

Why do metal male threads cause so much damage when

threaded into plastic female threaded fittings? Why doesn't a plastic male thread cause as much of a problem? The answer is that when plastic-to-plastic threaded fittings are tightened, the female fitting expands and the male fitting compresses. The stress is shared equally between the two. However, when a metal male thread is tightened into a plastic female thread, stress is not shared equally. Since metal has a much greater strength compared to plastic, it does not compress when tightened. This places all the stress on the plastic female fitting.

### Female Adapters

An excellent example of an application where female plastic threads can be a problem is the use of PVC threaded caps to test a domestic water system. In this scenario a steel pipe nipple is connected to a newly constructed domestic water system and a PVC threaded cap is used to seal the nipple as shown in the photograph.



There are several problems with this application. First, the International and Uniform Plumbing Codes do not permit the use of PVC 40 pipe and fittings to be used in domestic water

## NOTICE

All pipe thread sealants must conform to the requirements of IAPMO's PS 36 and with the thread sealant manufacturer to confirm that these sealants are chemically compatible with ABS, CPVC, and PVC. Incompatible pipe thread sealants may result in the degradation of plastic pipe or fittings resulting in product failure and property damage.

- Verify that paints, thread sealants, lubricants, plasticized PVC products, foam insulations, caulks, leak detectors, insecticides, termiticides, antifreeze solutions, pipe sleeves, firestop materials or other materials are chemically compatible with ABS, CPVC, or PVC.
- Do not use edible oils such as Crisco® for lubricant.
- Confirm compatibility of pipe marking adhesive tape with the manufacturer of the tape to ensure chemical compatibility with CPVC pipe and fittings.

Exceeding recommended torque for threaded connections may result in component damage, system failure, and property damage.

**Never use thread sealant when installing a P-Trap or a Trap adapter with a plastic or metallic nut. Use of thread sealants could cause seal separation or cause damage to the fitting through over-tightening.**

**Maximum wrench-tightness is two turns past finger tight. Plastic or metal nuts should be tightened with a strap wrench only. Never use common wrenches or tools designed for metallic pipe systems.**

systems within the walls of a building, so this application is not code compliant and therefore excluded under the Charlotte Pipe and Foundry limited warranty. Second, these parts are produced to conform to ASTM D 2466 for pressure piping applications, and are not designed to be part of a test apparatus for repeated and temporary installation and testing of domestic water systems. If not installed correctly and properly tightened, system or property damage could result. For this application galvanized malleable iron threaded caps would be recommended.

## Do's and Don'ts For Threaded Connections

### Do's

- Avoid female plastic pipe threads whenever possible.
- CPVC plastic threaded male adapters are recommended for cold water applications only.
- CPVC brass threaded transition fittings are recommended for hot and cold water applications. Brass threaded transition fittings are manufactured from low lead brass and are available in male, female and drop ear ell configurations.

- Only join to threaded components conforming to ANSI/ASME B 1.20.1 or ASTM F 1498.
- De-rate plastic threaded fittings an additional 50% beyond the pressure rating for pipe and fittings.
- Use Teflon tape for thread sealant on 1" and smaller only.
- Tighten threaded connections using a strap wrench only.
- Tighten threaded connections a maximum of two turns past finger tight.
- Make threaded plastic fitting connections in conformance to ASTM F 1498

### Don'ts

- Use pneumatic tools for tightening.
- Never clamp female brass threaded transition fittings in a vise.
- Never apply more than light pressure on male brass or CPVC threaded fittings when clamping in a vise.
- Never tighten threaded fittings using common wrenches or tools designed for metallic piping systems.
- Never tighten threaded connections more than two turns past finger tight.
- Never use ABS, CPVC, or PVC threaded caps as part of an assembly to test a domestic water system.



## Taper Thread Dimensions

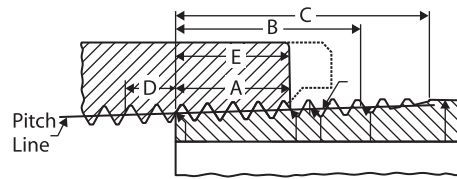

\*Per ANSI/ASME B1.20.1 and ASTM F 1498

PIPE		THREADS	* EXTERNAL THREAD			* INTERNAL THREAD
Nominal Size In Inches	Outside Diameter In Inches	Number of Threads Per Inch	Normal Engagement By Hand In Inches (A)	Length of Effective Thread In Inches (B)	Total Length: End of Pipe to Vanish Point In Inches (C)	Wrench Makeup Length for Internal Thread (D)
1/4	.540	18	.228	.4018	.5946	.111
3/8	.675	18	.240	.4078	.6006	.111
1/2	.840	14	.320	.5337	.7815	.143
3/4	1.050	14	.339	.5457	.7935	.143
1	1.315	11 1/2	.400	.6828	.9845	.174
1 1/4	1.660	11 1/2	.420	.7068	1.0085	.174
1 1/2	1.900	11 1/2	.420	.7235	1.0252	.174
2	2.375	11 1/2	.436	.7565	1.0582	.174
2 1/2	2.875	8	.682	1.1375	1.5712	.250
3	3.500	8	.766	1.2000	1.6337	.250
4	4.500	8	.844	1.3000	1.7337	.250
6	6.625	8	.958	1.5125	1.9462	.250
8	8.625	8	1.063	1.7125	2.1462	.250
10	10.750	8	1.210	1.925	2.3587	.250
12	10.750	8	1.360	2.125	2.5587	.250

### NOTICE

All pipe thread sealants must conform to the requirements of IAPMO's PS 36 and with the thread sealant manufacturer to confirm that these sealants are chemically compatible with ABS, CPVC, and PVC. Incompatible pipe thread sealants may result in the degradation of plastic pipe or fittings resulting in product failure and property damage.

- Verify that paints, thread sealants, lubricants, plasticized PVC products, foam insulations, caulks, leak detectors, insecticides, termiticides, antifreeze solutions, pipe sleeves, firestop materials or other materials are chemically compatible with ABS, CPVC, or PVC.
- Do not use edible oils such as Crisco® for lubricant.
- Confirm compatibility of pipe marking adhesive tape with the manufacturer of the tape to ensure chemical compatibility with CPVC pipe and fittings.

Exceeding recommended torque for threaded connections may result in component damage, system failure, and property damage.

Never use thread sealant when installing a P-Trap or a Trap adapter with a plastic or metallic nut. Use of thread sealants could cause seal separation or cause damage to the fitting through over-tightening.

Maximum wrench-tightness is two turns past finger tight. Plastic or metal nuts should be tightened with a strap wrench only. Never use common wrenches or tools designed for metallic pipe systems.



## Fluid Flow Properties

### Gravity Flow

#### Manning Roughness Factor ("N" Value)

Fluid velocity, pipe size and hydraulic slope for gravity drainage can be determined using the Manning "N" value. This coefficient relates to the interior wall smoothness of pipe and is used for liquids with a steady flow, at a constant depth, in a prismatic open channel. The Manning's equation is shown below:

$$V = \frac{1.486 R^{2/3} S^{1/2}}{N}$$

Where:

V = Velocity of flow, ft./second

N = Manning's value

r = hydraulic radius, ft. obtained by dividing the cross sectional area of flow by the wetted perimeter of the pipe in contact with the flow. R is a special case for v with pipes either 1/2 full or full:

R = Inside diameter / 4, in feet

$$S = \frac{\text{Upstream elevation} - \text{Down stream elevation}}{\text{pipe length}} \text{ (ft./ft.)}$$

Example 1:

2" diameter Schedule 40 PVC,

flowing full 30 foot pipe run, 7.5 inch drop

$$S = \frac{17.5'' - 10.0''}{30 \text{ ft.}} = 0.0208 \text{ ft./ft.}$$

$$R = \frac{2.067''}{4} = 0.043 \text{ ft.}$$

$$V = \frac{1.486 R^{2/3} S^{1/2}}{N}$$

Manning's "N" value is generally accepted as 0.009 for Designing gravity sewer systems

$$V = \frac{1.486 (0.043)^{2/3} (0.0208)^{1/2}}{0.009}$$

$$V = 2.9 \text{ ft./second}$$

Example 2:

4" diameter Schedule 40 ABS, flowing 1/2 full

10 foot pipe run, 1.5 inch drop

$$S = \frac{20'' - 18.5''}{10 \text{ ft.}} = 0.0125 \text{ ft./ft.}$$

$$R = \frac{4.026''}{4} = 0.0839 \text{ ft.}$$

Assume "N" to be 0.009

$$V = \frac{1.486 (0.0839)^{2/3} (0.0125)^{1/2}}{0.009}$$

$$V = 3.6 \text{ ft./second}$$

It is widely recommended that the flow velocity in sanitary sewer systems to be equal to or greater than 2.0 feet per second for self cleaning drain lines.

Laboratory tests have shown that the "N" value for ABS and PVC pipe ranges from .008 to .012. The table below shows "N" values for other piping materials.

#### "N" Values For Typical Piping Materials

Piping Material	"N" Values
Cast Iron	.011 - .015
Finished Concrete	.011 - .015
Unfinished Concrete	.013 - .017
Corrugated Metal	.021 - .027
Glass	.009 - .013
Clay	.011 - .017

### Fluid Flow Rate

Calculation of Volume Flow Rate:

$$Q = aV$$

Where:

a = Cross sectional area of flow, ft.<sup>2</sup>

V = Flow Velocity, ft/sec

Q = Volume flow rate, ft<sup>3</sup>/sec

Example 1:

2" Schedule 40 PVC

Where:

di = inside diameter of pipe in inches

$$a = \frac{\pi di^2}{4} = \frac{\pi (2.06712)^2}{4} = 0.0233 \text{ ft}^2$$

$$V = 2.9 \text{ ft/sec}$$

$$Q = 0.0233 \times 2.9 = 0.0676 \text{ ft}^3/\text{sec}$$

$$Q = \frac{0.0676 \text{ ft}^3}{\text{sec}} \times \frac{7.48 \text{ gal}}{\text{ft}^3} \times \frac{60 \text{ sec}}{\text{min}} = \frac{30.3 \text{ gals}}{\text{min}}$$

Example 2:

4" Schedule 40 ABS, flowing 1/2 full

$$a/2 = \frac{\pi (di)^2}{4(2)} = \frac{\pi (4.02612)^2}{4(2)} = .044 \text{ ft}^2$$

$$V = 3.6 \text{ ft/sec}$$

$$Q = .044 \times 3.6 = 0.158 \text{ ft}^3/\text{sec}$$

$$Q = \frac{0.158 \text{ ft}^3}{\text{sec}} \times \frac{7.48 \text{ gal}}{\text{ft}^3} \times \frac{60 \text{ sec}}{\text{min}} = \frac{71 \text{ gals}}{\text{min}}$$

## Pressure Flow

Friction loss through PVC pipe is normally obtained by using the Hazen-Williams equation shown below for water:

$$f = 0.2083 \times \left(\frac{100}{C}\right)^{1.852} \times \frac{Q^{1.852}}{di^{4.8655}}$$

Where:

- f = friction head loss in feet of water per 100 feet of pipe
- C = constant for inside pipe roughness (C = 150 for ABS and PVC pipe)
- Q = flow in U.S. gallons per minute
- di = inside diameter of pipe in inches

## Water Velocities

Water velocities in feet per second may be calculated as follows:

$$V = 0.408709 \frac{Q}{di^2}$$

Where:

- V = velocity in feet per second
- Q = flow in U.S. gallons per minute
- di = inside diameter of pipe in inches

## Friction Loss Through Fittings

The friction loss through fittings is considered to be equivalent to the loss through a certain number of linear feet of pipe of the same diameter as the fittings. To determine the loss through a piping system, add together the number of "equivalent feet" calculated for the fittings in the system.

The chart below shows approximate friction losses, in equivalent feet, for a variety of Schedule 40 & 80 PVC and CPVC fittings of different sizes.

### Approximate Friction Loss For PVC and CPVC Fittings In Equivalent Feet Of Straight Pipe

Fitting	½"	¾"	1"	1¼"	1½"	2"	2½"	3"	4"	6"	8"	10"	12"
Tee (Run)	1.0	1.4	1.7	2.3	2.7	4.3	5.1	6.2	8.3	12.5	16.5	17.5	20.0
Tee (Branch)	4.0	5.0	6.0	7.3	8.4	12.0	15.0	16.4	22.0	32.7	49.0	57.0	67.0
90° Elbow	1.5	2.0	2.5	3.8	4.0	5.7	6.9	7.9	12.0	18.0	22.0	26.0	32.0
45° Elbow	.80	1.1	1.4	1.8	2.1	2.6	3.1	4.0	5.1	8.0	10.6	13.5	15.5
Male/Female Adapter	1.0	1.5	2.0	2.75	3.5	4.5	5.5	6.5	9.0	14.0	—	—	—

See the table on the following page which shows friction heads in feet and friction losses in psi for Schedule 40 pipe. It also shows the gallons per minute (GPM) and velocities (in feet per second) for various pipe sizes.



# FRICION LOSS AND FLOW VELOCITY FOR SCHEDULE 80 THERMOPLASTIC PIPE

(Friction head and friction loss are per 100 feet of pipe.)

**NOTICE:** Flow velocity should not exceed 5 feet per second. Velocities in excess of 5 feet per second may result in system failure and property damage.

Gallons Per Minute	Velocity Feet Per Second	Friction Head Feet	Friction Loss Pounds Per Square Inch	Velocity Feet Per Second	Friction Head Feet	Friction Loss Pounds Per Square Inch	Velocity Feet Per Second	Friction Head Feet	Friction Loss Pounds Per Square Inch	Velocity Feet Per Second	Friction Head Feet	Friction Loss Pounds Per Square Inch	Velocity Feet Per Second	Friction Head Feet	Friction Loss Pounds Per Square Inch
1	1.48	2.24	0.97	0.78	0.49	0.21	0.52	0.12	0.05	0.38	0.05	0.02	0.38	0.05	0.02
2	2.95	8.08	3.50	1.57	2.67	1.16	1.30	0.64	0.28	0.94	0.13	0.13	0.94	0.29	0.13
5	7.39	44.12	19.13	3.92	9.45	4.10	2.99	1.82	0.52	2.49	0.24	0.24	2.49	0.54	0.24
7	10.34	82.27	35.67	5.49	17.62	7.64	4.27	2.32	1.00	3.35	0.46	0.46	3.35	0.88	0.46
10				7.84	34.11	14.79	5.99	3.13	1.23	4.69	0.63	0.63	4.69	1.19	0.63
15				11.76	72.27	31.33	8.36	4.91	2.13	6.49	0.97	0.97	6.49	1.68	0.97
20	0.57	0.04	0.02				10.38	5.19	3.62	9.08	1.65	1.65	9.08	2.23	1.65
25	0.71	0.06	0.03				11.66	8.86	5.48	12.64	2.49	2.49	12.64	3.35	2.49
30	0.86	0.08	0.04				14.00	12.64	7.68	17.71	3.49	3.49	17.71	4.69	3.49
35	1.00	0.11	0.05					17.71	10.21	24.92	5.03	5.03	24.92	6.49	5.03
40	1.14	0.14	0.06					24.92	13.71	33.53	6.49	6.49	33.53	8.04	6.49
45	1.28	0.17	0.08					33.53	17.05	44.69	8.04	8.04	44.69	9.91	8.04
50	1.43	0.21	0.09					44.69	20.72	58.98	9.91	9.91	58.98	12.59	9.91
60	1.71	0.30	0.13					58.98	29.04	81.25	12.59	12.59	81.25	16.22	12.59
70	2.00	0.39	0.17					81.25	39.38	109.78	16.22	16.22	109.78	21.18	16.22
75	2.14	0.45	0.19					109.78	45.62	125.99	21.18	21.18	125.99	25.53	21.18
80	2.28	0.51	0.22					125.99	52.64	144.00	25.53	25.53	144.00	29.04	25.53
90	2.57	0.76	0.33					144.00	63.00	177.11	29.04	29.04	177.11	33.53	29.04
100	2.85	1.16	0.50					177.11	77.11	211.17	33.53	33.53	211.17	38.33	33.53
125	3.56	1.62	0.70					211.17	91.25	255.33	38.33	38.33	255.33	44.69	38.33
150	4.28	2.16	0.93					255.33	109.78	300.00	44.69	44.69	300.00	52.64	44.69
175	4.99	2.76	1.20					300.00	132.00	353.53	52.64	52.64	353.53	61.25	52.64
200	5.70	3.41	1.57					353.53	158.33	416.67	61.25	61.25	416.67	70.78	61.25
250	7.13	4.17	2.14					416.67	197.78	500.00	70.78	70.78	500.00	81.25	70.78
300	8.55	5.85	2.94					500.00	250.00	600.00	81.25	81.25	600.00	93.75	81.25
350	9.98	7.78	3.97					600.00	312.50	720.00	93.75	93.75	720.00	107.67	93.75
400	11.41	9.96	5.32					720.00	390.00	864.00	107.67	107.67	864.00	122.92	107.67
450								864.00	484.00	1027.11	122.92	122.92	1027.11	139.58	122.92
500								1027.11	594.00	1210.00	139.58	139.58	1210.00	157.67	139.58
750								1210.00	937.50	1811.67	157.67	157.67	1811.67	236.67	157.67
1000								1811.67	1400.00	2700.00	236.67	236.67	2700.00	353.53	236.67
1250								2700.00	2025.00	3645.00	353.53	353.53	3645.00	496.67	353.53
1500								3645.00	2812.50	4950.00	496.67	496.67	4950.00	666.67	496.67
2000								4950.00	3937.50	6750.00	666.67	666.67	6750.00	916.67	666.67
2500								6750.00	5400.00	9375.00	916.67	916.67	9375.00	1250.00	916.67
3000								9375.00	7275.00	12900.00	1250.00	1250.00	12900.00	1675.00	1250.00
3500								12900.00	9562.50	17475.00	1675.00	1675.00	17475.00	2200.00	1675.00
4000								17475.00	12262.50	23100.00	2200.00	2200.00	23100.00	2925.00	2200.00
4500								23100.00	15375.00	30000.00	2925.00	2925.00	30000.00	3950.00	2925.00
5000								30000.00	19900.00	39375.00	3950.00	3950.00	39375.00	5275.00	3950.00
5500								39375.00	25950.00	51750.00	5275.00	5275.00	51750.00	7125.00	5275.00
6000								51750.00	34500.00	69000.00	7125.00	7125.00	69000.00	9625.00	7125.00
6500								69000.00	45750.00	93750.00	9625.00	9625.00	93750.00	13000.00	9625.00
7000								93750.00	60750.00	126000.00	13000.00	13000.00	126000.00	17500.00	13000.00
7500								126000.00	80500.00	168000.00	17500.00	17500.00	168000.00	23375.00	17500.00
8000								168000.00	106250.00	225000.00	23375.00	23375.00	225000.00	31125.00	23375.00
8500								225000.00	139000.00	300000.00	31125.00	31125.00	300000.00	41125.00	31125.00
9000								300000.00	180000.00	396000.00	41125.00	41125.00	396000.00	54000.00	41125.00
9500								396000.00	239250.00	525000.00	54000.00	54000.00	525000.00	71875.00	54000.00
10000								525000.00	318750.00	700000.00	71875.00	71875.00	700000.00	95000.00	71875.00

# FRICITION LOSS AND FLOW VELOCITY FOR SDR 21 THERMOPLASTIC PIPE

(Friction head and friction loss are per 100 feet of pipe.)

**NOTICE:** Flow velocity should not exceed 5 feet per second. Velocities in excess of 5 feet per second may result in system failure and property damage.

Gallons Per Minute	1/2 in.			3/4 in.			1 in.			1 1/4 in.			1 1/2 in.			2 in.			2 1/2 in.			3 in.		
	Velocity Feet Per Second	Friction Head Feet	Friction Loss Pounds Per Square Inch	Velocity Feet Per Second	Friction Head Feet	Friction Loss Pounds Per Square Inch	Velocity Feet Per Second	Friction Head Feet	Friction Loss Pounds Per Square Inch	Velocity Feet Per Second	Friction Head Feet	Friction Loss Pounds Per Square Inch	Velocity Feet Per Second	Friction Head Feet	Friction Loss Pounds Per Square Inch	Velocity Feet Per Second	Friction Head Feet	Friction Loss Pounds Per Square Inch	Velocity Feet Per Second	Friction Head Feet	Friction Loss Pounds Per Square Inch	Velocity Feet Per Second	Friction Head Feet	Friction Loss Pounds Per Square Inch
1	0.84	0.57	0.25	0.49	0.16	0.07	0.37	0.05	0.02	0.28	0.03	0.01	0.18	0.01	0.00	0.31	0.02	0.04	0.21	0.01	0.00	0.21	0.01	0.00
2	1.69	2.07	0.90	0.99	0.56	0.24	0.93	0.29	0.12	0.71	0.15	0.06	0.45	0.05	0.02	0.71	0.15	0.06	0.29	0.01	0.01	0.29	0.01	0.01
5	4.22	11.29	4.90	2.47	3.06	1.33	1.30	0.53	0.23	0.99	0.27	0.12	0.63	0.09	0.04	0.99	0.27	0.12	0.43	0.04	0.02	0.43	0.04	0.02
7	5.91	21.06	9.13	3.45	5.71	2.48	1.86	1.03	0.45	1.41	0.53	0.23	0.90	0.18	0.08	1.41	0.53	0.23	0.61	0.07	0.03	0.61	0.07	0.03
10	8.44	40.77	17.68	4.94	11.06	4.80	2.79	2.18	0.95	2.12	1.12	0.49	1.35	0.37	0.16	2.12	1.12	0.49	0.92	0.15	0.06	0.92	0.15	0.06
15				7.40	23.44	10.16	3.72	3.72	1.61	2.83	1.91	0.83	1.80	0.64	0.28	2.83	1.91	0.83	1.23	0.25	0.11	1.23	0.25	0.11
20				9.87	39.94	17.31	4.65	5.63	2.44	3.54	2.89	1.25	2.25	0.97	0.42	3.54	2.89	1.25	1.53	0.38	0.16	1.53	0.38	0.16
25							4.65	7.89	3.42	4.24	4.05	1.75	2.71	1.35	0.59	4.24	4.05	1.75	1.84	0.53	0.23	1.84	0.53	0.23
30							5.58	10.49	4.55	4.95	5.38	2.33	3.16	1.80	0.78	4.95	5.38	2.33	2.15	0.71	0.31	2.15	0.71	0.31
35							6.51	13.44	5.83	5.66	6.89	2.99	3.61	2.31	1.00	5.66	6.89	2.99	2.45	0.90	0.39	2.45	0.90	0.39
40							7.44	16.71	7.25	6.36	8.57	3.72	4.06	2.87	1.24	6.36	8.57	3.72	2.76	1.12	0.49	2.76	1.12	0.49
45							8.37	20.31	8.81	7.07	10.42	4.52	4.51	3.49	1.51	7.07	10.42	4.52	3.07	1.37	0.59	3.07	1.37	0.59
50							9.30	28.47	12.34	8.49	14.60	6.33	5.41	4.89	2.12	8.49	14.60	6.33	3.68	1.91	0.83	3.68	1.91	0.83
60							11.17			9.90	19.43	8.42	6.31	6.50	2.82	9.90	19.43	8.42	4.29	2.55	1.10	4.29	2.55	1.10
70										10.61	22.08	9.57	7.21	7.39	3.20	10.61	22.08	9.57	4.60	2.89	1.26	4.60	2.89	1.26
75													8.12	8.32	3.61				4.91	3.26	1.41	4.91	3.26	1.41
80													9.02	10.35	4.49				5.52	4.06	1.76	5.52	4.06	1.76
90														12.58	5.46				6.14	4.93	2.14	6.14	4.93	2.14
100																			7.67	7.46	3.23	7.67	7.46	3.23
125																			9.20	10.45	4.53	9.20	10.45	4.53
150																			10.74	13.90	6.03	10.74	13.90	6.03
200																								
250																								
300																								
350																								
400																								
450																								
500																								
750																								
1000																								
1250																								
1500																								
2000																								
2500																								
3000																								
3500																								
4000																								
4500																								

# FRICITION LOSS AND FLOW VELOCITY FOR SDR 26 THERMOPLASTIC PIPE

(Friction head and friction loss are per 100 feet of pipe.)

**NOTICE: Flow velocity should not exceed 5 feet per second. Velocities in excess of 5 feet per second may result in system failure and property damage.**

Gallons Per Minute	1 in.			1½ in.			2 in.			2½ in.			3 in.		
	Velocity Feet Per Second	Friction Head Feet	Friction Loss Pounds Per Square Inch	Velocity Feet Per Second	Friction Head Feet	Friction Loss Pounds Per Square Inch	Velocity Feet Per Second	Friction Head Feet	Friction Loss Pounds Per Square Inch	Velocity Feet Per Second	Friction Head Feet	Friction Loss Pounds Per Square Inch	Velocity Feet Per Second	Friction Head Feet	Friction Loss Pounds Per Square Inch
1	0.59	0.16	0.07	0.36	0.05	0.02	0.17	0.01	0.00	0.29	0.02	0.01	0.20	0.01	0.00
2	1.48	0.88	0.38	0.89	0.26	0.11	0.43	0.04	0.02	0.41	0.03	0.01	0.28	0.01	0.01
5	2.07	1.65	0.71	1.25	0.48	0.21	0.61	0.08	0.04	0.59	0.06	0.03	0.40	0.02	0.01
7	2.96	3.18	1.38	1.79	0.94	0.41	0.87	0.16	0.07	0.88	0.13	0.06	0.59	0.05	0.02
10	4.44	6.76	2.93	2.68	1.98	0.86	1.30	0.34	0.15	1.18	0.23	0.10	0.79	0.09	0.04
15	5.92	11.52	4.99	3.58	3.38	1.46	1.73	0.58	0.25	1.47	0.34	0.15	0.99	0.13	0.06
20	7.40	17.41	7.55	4.47	5.10	2.21	2.16	0.87	0.38	1.77	0.48	0.21	1.19	0.18	0.08
25	8.88	24.40	10.58	5.36	7.15	3.10	2.60	1.23	0.53	2.06	0.64	0.28	1.39	0.24	0.11
30	10.36	32.46	14.07	6.26	9.52	4.13	3.03	1.63	0.71	2.35	0.82	0.35	1.59	0.31	0.14
35				7.15	12.19	5.28	3.46	2.09	0.90	2.65	1.02	0.44	1.78	0.39	0.17
40				8.04	15.16	6.57	3.89	2.60	1.13	2.94	1.24	0.54	1.98	0.47	0.20
45				8.94	18.43	7.99	4.33	3.16	1.37	3.53	1.73	0.75	2.38	0.66	0.29
50							5.19	4.42	1.92	4.12	2.30	1.00	2.78	0.88	0.38
60							6.06	5.88	2.55	4.41	2.62	1.13	2.97	1.00	0.43
70							6.49	6.60	2.86	4.71	2.95	1.28	3.17	1.13	0.49
75							6.92	7.54	3.27	5.30	3.67	1.59	3.57	1.40	0.61
80							7.79	9.37	4.06	5.89	4.46	1.93	3.97	1.71	0.74
90							8.66	11.39	4.94	7.36	6.74	2.92	4.96	2.58	1.12
100										8.83	9.45	4.10	5.95	3.62	1.57
125										10.30	12.57	5.45	6.94	4.81	2.09
150													7.93	6.16	2.67
175													9.92	9.31	4.04
200															
250															
300															
350															
400															
450															
500															

# FRICITION LOSS AND FLOW VELOCITY FOR SDR 11 CTS CPVC THERMOPLASTIC PIPE

(Friction head and friction loss are per 100 feet of pipe.)

**NOTICE: Flow velocity should not exceed 8 feet per second. Velocities in excess of 8 feet per second may result in system failure and property damage.**

Gallons Per Minute	½ in.			¾ in.			1 in.			1¼ in.			1½ in.			2 in.		
	Velocity Feet Per Second	Head Loss Feet of Water Per 100 Ft.	Pressure Loss PSI Per 100 Ft.	Velocity Feet Per Second	Head Loss Feet of Water Per 100 Ft.	Pressure Loss PSI Per 100 Ft.	Velocity Feet Per Second	Head Loss Feet of Water Per 100 Ft.	Pressure Loss PSI Per 100 Ft.	Velocity Feet Per Second	Head Loss Feet of Water Per 100 Ft.	Pressure Loss PSI Per 100 Ft.	Velocity Feet Per Second	Head Loss Feet of Water Per 100 Ft.	Pressure Loss PSI Per 100 Ft.	Velocity Feet Per Second	Head Loss Feet of Water Per 100 Ft.	Pressure Loss PSI Per 100 Ft.
1	1.71	3.19	1.38	0.80	0.50	0.22	0.48	0.15	0.06	1.61	1.09	0.47	1.16	0.49	0.21	0.68	0.13	0.06
2	3.42	11.53	5.00	1.60	1.82	0.79	0.96	0.53	0.23	3.23	3.94	1.71	2.31	1.75	0.76	1.35	0.47	0.21
3	5.13	24.43	10.59	2.40	3.85	1.67	1.45	1.12	0.49	4.84	8.35	3.62	3.47	3.71	1.61	2.03	1.00	0.44
4	6.84	41.64	18.04	3.20	6.55	2.84	1.93	1.91	0.83	6.46	14.23	6.17	4.63	6.33	2.74	2.70	1.71	0.74
5	8.55	62.91	27.27	4.00	9.91	4.29	2.41	2.89	1.25	8.07	21.51	9.33	5.79	9.56	4.15	3.38	2.58	1.12
6	10.26	88.18	38.23	4.80	13.89	6.02	2.89	4.05	1.76	9.69	30.15	13.07	6.94	13.40	5.81	4.05	3.62	1.57
7	11.96	117.32	50.86	5.60	18.47	8.01	3.37	5.39	2.34	11.30	40.11	17.39	8.10	17.83	7.73	4.73	4.82	2.09
8	13.67	150.23	65.13	6.40	23.66	10.26	3.85	6.90	2.99	12.92	51.37	22.37	9.26	22.83	9.90	5.41	6.17	2.68
9	15.38	186.85	81.00	7.20	29.42	12.76	4.34	8.58	3.72	14.53	63.89	27.70	10.41	28.40	12.31	6.08	7.68	3.33
10	17.09	227.11	98.46	7.99	35.76	15.50	4.82	10.43	4.52	16.15	77.66	33.67	11.57	34.52	14.96	6.76	9.33	4.04
15				11.99	75.78	32.85	7.23	22.11	9.59	17.76	92.65	40.17	12.73	41.18	17.85	7.43	11.13	4.83
20				15.99	129.11	55.97	9.64	37.67	16.33	18.88	106.19	46.04	13.88	48.38	20.98	8.11	13.08	5.67
25							12.05	56.94	24.69				16.20	64.37	27.91	9.46	17.40	7.54
30							14.45	79.82	34.60							10.81	22.28	9.66
35							16.86	106.19	46.04							12.16	27.71	12.01
40																13.51	33.68	14.60
45																16.89	50.92	22.07
50																		
55																		
60																		
70																		
80																		
90																		
100																		
125																		



## Water Hammer

Water hammer is a term used to describe the sudden increase in pressure created by quickly stopping, starting, or changing the direction of the flow of fluid in a piping system. Typical actions which cause water hammer are:

- (1) Quickly closing a valve.
- (2) Quickly opening a valve.
- (3) Starting pumps with an empty discharge line.
- (4) A high speed wall of liquid (such as starting a pump) suddenly changes direction (such as going through a 90° elbow).
- (5) Moving entrapped air through the system.

The pressure increase generated must be added to the fluid pressure already existing in the piping system to determine the total pressure the system must withstand. **CAUTION!** If water hammer is not accounted for, the sudden pressure surge could be enough to burst the pipe, or break the fittings or valves.

Taking the following measures will help prevent problems:

- (1) Keep fluid velocities under 5 feet per second for PVC and 8 feet per second for CTS CPVC.
- (2) Use actuated valves with controlled opening and closing speeds.
- (3) Instruct operators of manual valves on the proper opening and closing speeds.
- (4) When starting a pump, partially close the valve in the discharge line to minimize the volume of liquid accelerating through the system. Fully open the valve after the line is completely filled.
- (5) Use a check valve in the pipe line, near the pump, to keep the line full.
- (6) Use air relief valves to control the amount of air that is admitted or exhausted throughout the piping system.
- (7) Design the piping system so that the total pressure (operating plus water hammer surge) does not exceed the pressure rating of the lowest rated component in the system.

## Water Hammer Arrestors

Quick closing valves, actuated valves, starting or stopping pumps or rapid increases or decreases in system flow rate can result in pressure surge or "water hammer" capable of damaging PVC or CPVC piping systems. Systems should be designed by the engineer of record and in conformance to local code requirements to manage the effects of pressure

surge. In applications where severe or repeated water hammer is encountered, especially at elevated temperatures or in a commercial laundry or commercial kitchen, the use of a water hammer arrestor is advisable.

## How To Use The Nomograph On The Following Page:

1. Liquid Velocity (feet/second), pipeline length (feet), and valve closing time (seconds) must be known.
2. Place a straight edge on the liquid velocity in pipe (line A) and the pipeline length (line D).
3. Mark intersection of straight edge with pivot line (line C).
4. Place straight edge on mark just placed on pivot line (line C) and on valve closing time for valve being used (line A).
5. The intersection of the straight edge with the pressure increase line (line B) is the liquid momentum surge pressure (water hammer).

The liquid momentum surge pressure should be added to the operating line pressure to determine the system's maximum line pressure. The maximum line pressure is used to select the proper pipe schedule or wall thickness.

The nomograph is based on the formula

$$P = \frac{0.070VL}{T}$$

where P is increase in pressure due to momentum surge in psi, L is pipeline length in feet, V is liquid velocity in feet per second, and T is valve closing time in seconds.



Water Hammer Nomograph

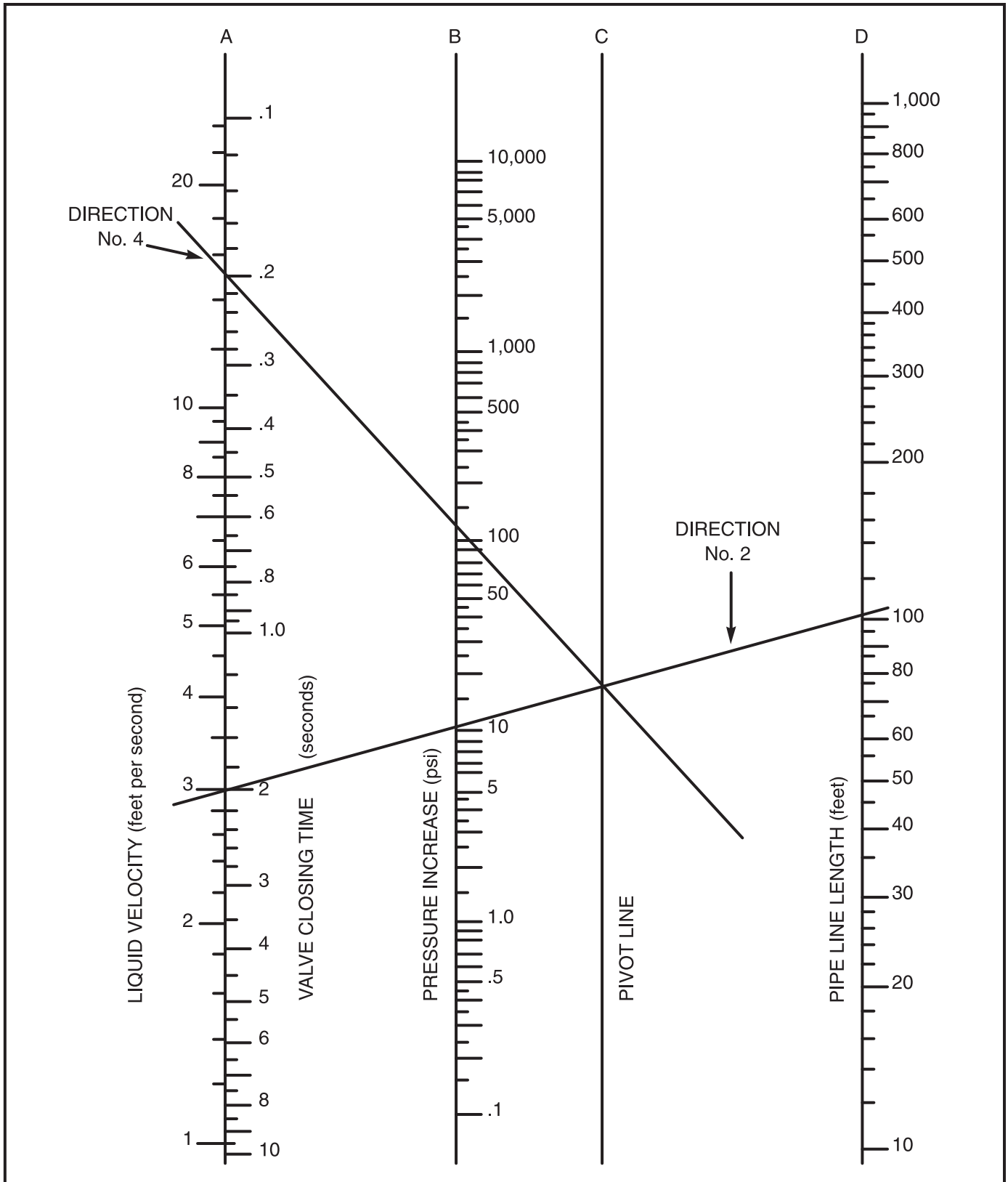

## Entrapped Air

### Source

There are many potential sources for air in pipelines. Air may be introduced at the point where fluid enters the system or during initial filling of the system.

### Problem

Air in a piping system tends to accumulate at high points in the system. As the flowrate increases, the entrapped air is forced along the pipeline by the moving water. These pockets of air cause flow restrictions reducing the efficiency and performance of the system. Water is about 5 times more dense than air at 100 psi, so when a pocket of air reaches an outlet, it escapes rapidly and water rushes to replace the void. Such pressure surges can easily exceed the strength of a piping system and it's components.

## WARNING

**Entrapped Air**

- **Pressure surges associated with entrapped air may result in serious personal injury, system failure, and property damage.**
- Install air relief valves at the high points in a system to vent air that accumulates during service.
- Failure to bleed trapped air may give faulty test results and may result in an explosion.

### Solution

Designers should be concerned about entrapped air, but the issue of entrapped air is very complex. The behavior of air in a piping system is not easy to analyze, but the effects can be devastating. Obviously, the best way to reduce problems would be to prevent air from entering the system. Systems should be filled slowly and air vented from the high points before the system is pressurized. Additionally, air relief valves should be installed at high points in the system to vent air that accumulates during service.

## WEATHERING

### UV Exposure

ABS, CPVC, and PVC pipe can suffer surface discoloration when exposed to ultraviolet (UV) radiation from sunlight. UV radiation affects ABS, CPVC, and PVC when energy from the sun causes excitation of the molecular bonds in the plastic. The resulting reaction occurs only on the exposed surface of the pipe and to the extremely shallow depths of .001 to .003 inches. The effect does not continue when exposure to sunlight is terminated.

A two-year study was undertaken to quantify the effects of UV radiation on the properties of PVC pipe (See Uni-Bell's UNI-TR-5). The study found that exposure to UV radiation results in a change in the pipe's surface color and a reduction in impact strength. Other properties such as tensile strength (pressure rating) and modulus of elasticity (pipe stiffness) are not adversely affected.

The presence of an opaque shield between the sun and the pipe prevents UV degradation. UV radiation will not penetrate thin shields such as paint coatings or wrappings. Burial of ABS, CPVC, and PVC pipe provides complete protection against UV attack.

The most common method used to protect above ground ABS, CPVC, and PVC pipe from the sun is painting with a latex (water base) paint. Preparation of the surface to be painted is very important. The pipe should be cleaned to remove moisture, dirt, and oil and wiped with a clean, dry cloth. **NOTICE:** Petroleum-based paints should not be used, since the presence of petroleum will prevent proper bonding of paint to pipe.

Reference: Uni-Bell PVC Pipe Association 2001.

### Heat Build-Up

In addition to considering ambient air and operating temperatures in a piping system, piping designers must consider the radiant effect of sunlight when selecting piping material. Testing to the ASTM D 4803 Standard Test Method for Predicting Heat Build-up in PVC Building Products indicates that radiant heat from the sun can increase pipe surface temperatures by 50°F or more, possibly causing a piping system to exceed maximum working temperature or de-rated pressure carrying capability. Painting dark colored pipe with a light pigmented water based paint may reduce, but will not eliminate heat build-up.

## Horizontal and Vertical Support For ABS, CPVC, and PVC Pipe

Adequate support for any piping system is a matter of great importance. In practice, support spacings are a function of pipe size, operating temperatures, the location of heavy valves or fittings, and the mechanical properties of the pipe material.

Most plumbing codes and building codes require support for horizontal pipe lines every 3 feet for pipe in 1/2"-1" diameters, and every 4 feet for pipe with diameters greater than 1". Support spacing should be in accordance with applicable plumbing and building codes.

To ensure the satisfactory operation of a DWV or pressure piping system, the location and type of hangers should be carefully considered. The principles of design for metallic piping systems are generally also applicable to DWV or pressure piping systems, but with some notable areas where special consideration should be exercised. Hangers should not compress, distort, cut or abrade the piping.

All piping should be supported with an approved hanger at intervals sufficiently close to maintain correct pipe alignment and to prevent sagging or grade reversal. Pipe should also be supported at all branch ends and at all changes of direction. Support trap arms as close as possible to the trap. In keeping with good plumbing practices, support and brace all closet bends and fasten closet flanges.

NOTICE

**Failure to compensate for expansion and contraction caused by temperature change may result in system failure and property damage.**

- Do not restrict expansion or contraction. Restraining movement in piping systems is not recommended and may result in joint or fitting failure.
- Use straps or clamps that allow for piping system movement.
- Align all piping system components properly without strain. Do not bend or pull pipe into position after being solvent welded.
- Do not terminate a pipe run against a stationary object (example: wall or floor joist).
- Do not install fittings under stress.

### Horizontal Piping

Support spacing for horizontal piping systems must be determined by the maximum operating temperature the system will encounter. The piping should be supported on uniform centers with supports that do not restrict the axis movement. Charlotte Pipe recommends supporting horizontal pipe and fittings at sufficiently close intervals to maintain alignment and prevent sagging or grade reversal. Use sway bracing, as needed to stabilize hanging systems against horizontal movement. Sway bracing is a non-rigid form of structural support that is well suited to installations in which components hang from a height greater than 18 inches.

### Vertical Piping

Charlotte Pipe recommends that an engineer design the vertical supports according to the vertical load involved. Support vertical piping at their bases and at sufficient floor intervals to meet the requirements of local codes. Riser clamps should be installed in accordance with the riser clamp manufacturer and should not be overtightened on any thermoplastic piping system.

### Special Considerations

- (1) Concentrated loads (ie: Valves and other appurtenances) should be supported directly so as to eliminate high stress concentrations. Should this be impractical, then the pipe must be supported immediately adjacent to the load.
- (2) In systems where large fluctuations in temperature occur, allowances must be made for expansion and contraction of the piping system. Since changes in direction in the system are usually sufficient to allow for expansion and contraction, hangers must be placed so as not to restrict this movement.
- (3) Since plastic pipe expands or contracts approximately five times more than steel, hangers should not restrict this movement. When using a clamp-type hanger, the hanger should not force the pipe and fittings into position.
- (4) Hangers should provide as much bearing surface as possible. To prevent damage to the pipe, file smooth any sharp edges or burrs on the hangers or supports.
- (5) The use of coated hangers with plastic pipe is neither recommended or necessary. If coated hangers are used, verify that the rubber or vinyl coating utilized does not contain plasticizers and is chemically compatible with the plastic pipe material.
- (6) Plastic piping systems must not be placed alongside steam or other high temperature pipe lines or other high temperature objects.
- (7) (9) Changes in direction should be supported as close as practical to the fitting to avoid introducing excessive torsional stresses into the system. Please see the associated chart showing the recommended support spacing according to size, schedule, and operating temperatures. These spacings apply to continuous spans of uninsulated lines, with no concentrated loads, conveying liquids with specific gravities of up to 1.00.
- (8) The pipe should not be anchored tightly by the support, but secured in a manner to allow for movement caused by thermal expansion and contraction. It is recommended that you use clamps or straps that allow pipe to remain away from the framing, thus reducing the noise generated when pipe is allowed to rub against wood.
- (9) Plastic insulators do not need to be used when CPVC pipe passes through wood studs. However, when CPVC pipe passes through metal studs, some forms of protection must be used to isolate the pipe from abrasion and to prevent noise.

**NOTICE:** The above information on this page provides general guidelines. It should be used only as a reference and not as a guarantee of performance. Specific installation instructions and techniques may be required as a result of local plumbing and building codes, engineering specifications and instructions.

## Typical Pipe Hangers, Clamps, and Supports

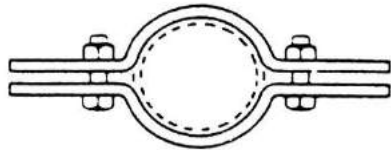

Riser Clamp

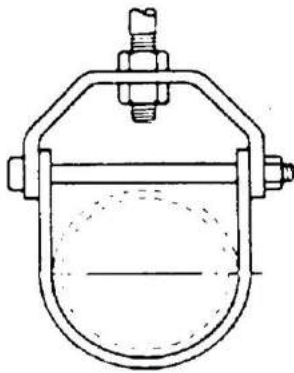

Clevis Hanger



Adjustable Swivel  
Ring Hanger

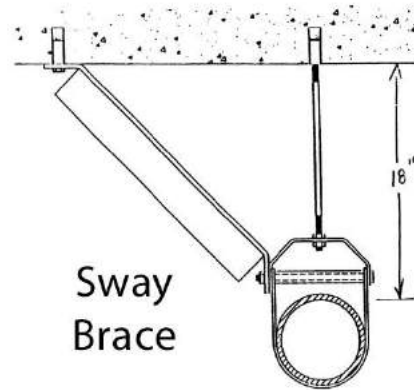

Sway  
Brace

The pipe should not be anchored tightly by the support, but secured in a manner to allow for movement caused by thermal expansion and contraction. It is recommended that you use clamps or straps that allow pipe to remain away from the framing, thus reducing the noise generated when pipe is allowed to rub against wood.

## General Guidelines for Horizontal Support Spacing (in feet)

Nom. Pipe Size (in.)	PVC PIPE															ABS PIPE				
	SDR 21 PR200 & SDR 26 PR160					Schedule 40					Schedule 80					Schedule 40				
	Operating Temp. °F					Operating Temp. °F					Operating Temp. °F					Operating Temp. °F				
	60	80	100	120	140	60	80	100	120	140	60	80	100	120	140	60	80	100	120	140
½	3½	3½	3	2		4½	4½	4	2½	2½	5	4½	4½	3	2½					
¾	4	3½	3	2		5	4½	4	2½	2½	5½	5	4½	3	2½					
1	4	4	3½	2		5½	5	4½	3	2½	6	5½	5	3½	3					
1¼	4	4	3½	2½		5½	5½	5	3	3	6	6	5½	3½	3					
1½	4½	4	4	2½		6	5½	5	3½	3	6½	6	5½	3½	3½	6	6	5½	3½	3
2	4½	4	4	3		6	5½	5	3½	3	7	6½	6	4	3½	6	6	5½	3½	3
2½	5	5	4½	3		7	6½	6	4	3½	7½	7½	6½	4½	4					
3	5½	5½	4½	3		7	7	6	4	3½	8	7½	7	4½	4	7	7	7	4	3½
4	6	5½	5	3½		7½	7	6½	4½	4	9	8½	7½	5	4½	7½	7½	7	4½	4
6	6½	6½	5½	4		8½	8	7½	5	4½	10	9½	9	6	5	8½	8½	8	5	4½
8	7	6½	6	5		9	8½	8	5	4½	11	10½	9½	6½	5½					
10						10	9	8½	5½	5	12	11	10	7	6					
12						11½	10½	9½	6½	5½	13	12	10½	7½	6½					
14						12	11	10	7	6	13½	13	11	8	7					
16						12½	11½	10½	7½	6½	14	13½	11½	8½	7½					

Nom. Pipe Size (in.)	CPVC PIPE									
	Schedule 80*						SDR 11			
	Operating Temp. °F						Operating Temp. °F			
	60	80	100	120	140	180	73	100	140	180
½	5½	5½	5	4½	4½	2½	4	4	3½	3
¾	5½	5½	5½	5	4½	2½	5	4½	4	3
1	6	6	6	5½	5	3	5½	5	4½	3
1¼	6½	6½	6	6	5½	3	6	5½	5	4
1½	7	7	6½	6	5½	3½	6½	6	5½	4
2	7	7	7	6½	6	3½	7½	7	6½	4
2½	8	7½	7½	7½	6½	4				
3	8	8	8	7½	7	4				
4	9	9	9	8½	7½	4½				
6	10	10½	9½	9	8	5				
8	11	11	10½	10	9	5½				
10	11½	11½	11	10½	9½	6				
12	12½	12½	12½	11	10½	6½				

NOTE: Always follow local code requirements for hanger spacing. Most plumbing codes have the following hanger spacing requirements:

- ABS and PVC pipe have a maximum horizontal hanger spacing of every four feet for all sizes.
- CPVC pipe or tubing has a maximum horizontal hanger spacing of every three feet for one inch and under and every four feet for sizes 1¼ inch and larger.

## Expansion and Contraction of ABS, CPVC, and PVC

ABS, CPVC, and PVC pipe, like other piping materials, undergo length changes as a result of temperature variations above and below the installation temperature. They expand and contract 4.5 to 5 times more than steel or iron pipe. The extent of the expansion or contraction is dependent upon the piping material's coefficient of linear expansion, the length of pipe between directional changes, and the temperature differential.

The coefficients of linear expansion (Y) for ABS, CPVC, and PVC (expressed in inches of expansion per 10°F temperature change per 100 feet of pipe) are as follows:

Material	Y (in./10°F/100 ft)
ABS	0.66
ABS Plus	0.500
CPVC	0.408
PVC	0.36

The amount of expansion or contraction can be calculated using the following formula:

$$\Delta L = \frac{Y (T_1 - T_2) \times L}{10 \times 100}$$

$\Delta L$  = Dimensional change due to thermal expansion or contraction (in.)

Y = Expansion coefficient (See table above.) (in./10°F/100 ft)

(T<sub>1</sub>-T<sub>2</sub>) = Temperature differential between the installation temperature and the maximum or minimum system temperature, whichever provides the greatest differential (°F).

L = Length of pipe run between changes in direction (ft)

Example: How much expansion (e) can be expected in a 60 foot straight run of 2" diameter PVC pipe installed at 70°F and operating at 120°F?

Solution:

$$\Delta L = .360 \frac{(120 - 70)}{10} \times \frac{60}{100} = .360 \times 5 \times .6 = 1.08 \text{ inches}$$

There are several ways to compensate for expansion and contraction. The most common methods are:

1. Expansion Loops (Fig. 1)
2. Offsets (Fig. 2)
3. Change in direction (Fig. 3)

## Modulus of Elasticity & Working Stress

Table 1

	ABS		CPVC		PVC	
	Modulus of Elasticity (psi)	Working Stress (psi)	Modulus of Elasticity (psi)	Working Stress (psi)	Modulus of Elasticity (psi)	Working Stress (psi)
73° F	250,000	N/A	423,000	2,000	400,000	2,000
90° F	240,000	N/A	398,000	1,8200	372,000	1,500
100° F	230,000	N/A	385,000	1,640	352,000	1,240
120° F	215,000	N/A	355,000	1,300	316,000	800
140° F	195,000	N/A	330,000	1,000	280,000	440
160° F	N/A	N/A	300,000	800	N/A	N/A
180° F	N/A	N/A	271,000	500	N/A	N/A
200° F	N/A	N/A	241,000	400	N/A	N/A

Per ASTM F 645

### Expansion Loop Formula

$$L = \sqrt{\frac{3 E D (\Delta L)}{2 S}}$$

Where:

L = Loop length (in.)

E = Modulus of elasticity at maximum temperature (psi) (Table 1)

S = Working Stress at maximum temperature (psi) (Table 1)

D = Outside diameter of pipe (in.) (pages 22-34)

$\Delta L$  = Change in length due to change in temperature (in.)

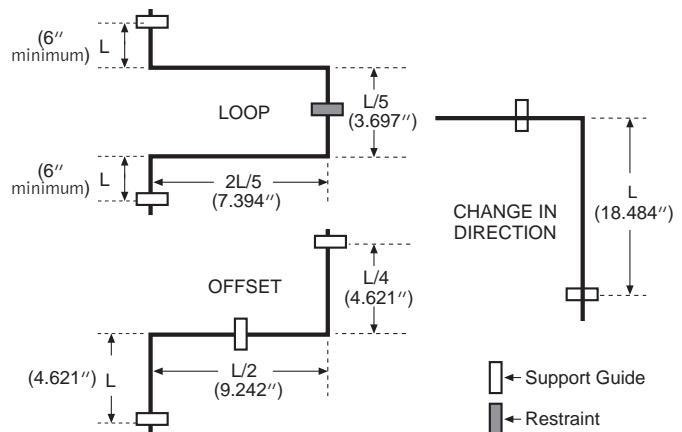

### Example:

CPVC 3/4" pipe operating at a maximum temperature of 180° F (T<sub>1</sub>) and at a minimum temperature of 70° F (T<sub>2</sub>) with a length of run of 10'.

The Modulus of Elasticity equals 271,000 and the Working Stress equals 500. The system will expand and contract 18.484 inches.

## Thermal Expansion in DWV and Storm Drainage Stacks

Plastic piping expands and contracts at a much greater rate than comparable metallic systems. Engineers, designers and installers should use resources such as the American Society of Plumbing Engineers Plumbing Engineering Design Handbook Volume 4, Chapter 11 ([www.aspe.org](http://www.aspe.org)) and the applicable local plumbing code to install stacks with adequate compensation for expansion and contraction. For vertical stacks in multi-story applications, compensation for expansion, contraction or building settling is often accommodated by the use of offsets or expansion joints. Secure above-ground vertical DWV or storm-drainage piping at sufficiently close intervals to maintain proper alignment and to support the weight of the piping and its contents. Support stack at base, and if over two stories in height, support stack at base and at each floor with approved riser clamps. Stacks should be anchored so that movement is directed to the offsets or expansion joints. If using expansion joints always follow the installation instructions and recommendations of the joint manufacturer. Compensation for thermal movement is usually not required for a vent system.

### NOTICE

**Failure to compensate for expansion and contraction caused by temperature change may result in system failure and property damage.**

- Do not restrict expansion or contraction. Restraining movement in piping systems is not recommended and may result in joint or fitting failure.
- Use straps or clamps that allow for piping system movement.
- Align all piping system components properly without strain. Do not bend or pull pipe into position after being solvent welded.
- Do not terminate a pipe run against a stationary object (example: wall or floor joist).
- Do not install fittings under stress.

## Expansion Joints

A wide variety of products are available to compensate for thermal expansion in piping systems including:

- Piston type expansion joints
- Bellows type expansion joints
- Flexible bends

The manufacturers of these devices should be contacted to determine the suitability of their products for the specific application. In many cases these manufacturers provide excellent technical information on compensation for thermal expansion. Information on these manufacturers and industry standard may be obtained through the Expansion Joint Manufacturers Association [WWW.EJMA.ORG](http://WWW.EJMA.ORG).

When installing an expansion loop, no rigid or restraining supports should be placed within the leg lengths of the loop. The loop should be installed as closely as possible to the mid-point between anchors. Piping support guides should restrict lateral movement and direct axial movement into the loop. Lastly, the pipe and fittings should be solvent cemented together, rather than using threaded connections.

## Thermal Expansion in Underground Systems

Temperature changes underground are not as extreme as those experienced above ground because the soil acts in an insulating nature, preventing quick temperature changes. This along with the temperature of the fluids being transported stabilize the effects of the temperature changes experienced.

Compensation for expansion and contraction of flexible piping can be achieved by snaking the pipe in the trench. Solvent cemented joints must be used. An approximate sine wave configuration with a displacement from the centerline and a maximum offset is shown below.

The following table shows recommended offsets and loop lengths for piping up to 3" nominal size.

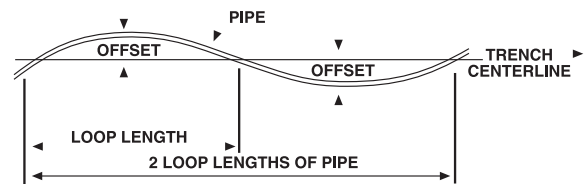

Loop Length In Feet	Max. Temp. Variation °F, Between Installation and Final Operation									
	10°	20°	30°	40°	50°	60°	70°	80°	90°	100°
	Loop Offset In Inches									
20	3.0	3.5	4.5	5.0	6.0	6.5	7.0	7.0	8.0	8.0
50	7.0	9.0	11.0	13.0	14.0	15.5	17.0	18.0	19.0	20.0
100	13.0	18.0	22.0	26.0	29.0	31.5	35.0	37.0	40.0	42.0

Note: This manual is not a complete engineering reference addressing all aspects of design and installation of thermal expansion in piping systems. Many excellent references are available on this topic. The American Society of Plumbing Engineers ([www.ASPE.org](http://www.ASPE.org)) Data Book, Volume 4, 2020-2021, Chapter 11 is an excellent resource for engineers on designing for thermal expansion.



## Permissible Bending Deflections for FlowGuard Gold® Pipe

FlowGuard Gold® pipe is inherently ductile allowing it to be deflected around or away from obstructions during installation. This allows for greater freedom of design and ease of installation. The minimum bend radius for 1/2" and 3/4" diameter coiled pipe is 18". The minimum bend radius for 1" diameter coiled pipe is 24".

**NOTICE:** DO NOT install fittings under stress. Pipe or tube must be properly restrained so that stress from deflected pipe is not transmitted to the fitting. The maximum installed deflection for FlowGuard Gold® CTS CPVC pipe is as follows:

### FlowGuard Gold Pipe, Length in Feet, SDR 11 (ASTM D 2846)

Nominal Pipe Size (in)	Pipe Length in Feet (L)													
	2	5	7	10	12	15	17	20	25	30	35	40	45	50
	<b>Permissible Bending Deflections (73°F) in inches - One End Restrained (d)</b>													
1/2	2.1	13.2	25.8	52.6	75.8	118.4	152.1	210.6	329.0	473.8	644.8			
3/4	1.5	9.4	18.4	37.6	54.1	84.6	108.7	150.4	235.0	338.4	460.6	601.6		
1	1.2	7.3	14.3	29.2	42.1	65.8	84.5	117.0	182.8	263.2	358.2	467.9	592.2	
1 1/4	1.0	6.0	11.7	23.9	34.5	53.8	69.1	95.7	149.5	215.3	293.1	382.8	484.5	598.2
1 1/2	0.8	5.1	9.9	20.2	29.2	45.6	58.5	81.0	126.5	182.2	248.0	323.9	410.0	506.2
2	0.6	3.9	7.6	15.5	22.3	34.8	44.7	61.9	96.8	139.3	189.7	247.7	313.5	387.1

## NOTICE

DO NOT install fittings under stress. Pipe or tube must be restrained so that stress from deflected pipe is not transmitted to the fitting. Installing fittings under stress may result in system failure and property damage.

### Maximum Installed Deflections (One End Restrained)

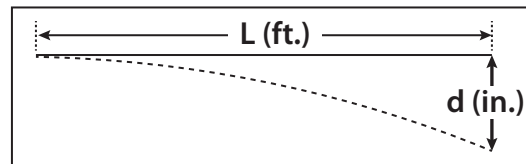

### FlowGuard Gold Pipe, Length in Feet, SDR 11 (ASTM D 2846)

Nominal Pipe Size (in)	Pipe Length in Feet (L)													
	2	5	7	10	12	15	17	20	25	30	35	40	45	50
	<b>Permissible Bending Deflections (73°F) in inches - Both Ends Restrained (d)</b>													
1/2	0.5	3.3	6.4	13.2	19.0	29.6	38.0	52.7	82.3	118.5	161.2	210.6	266.6	329.1
3/4	0.4	2.4	4.6	9.4	13.5	21.2	27.2	37.6	58.8	84.6	115.2	150.4	190.4	235.1
1	0.3	1.8	3.6	7.3	10.5	16.5	21.1	29.3	45.7	65.8	89.6	117.0	148.1	182.8
1 1/4	0.2	1.5	2.9	6.0	8.6	13.5	17.3	23.9	37.4	53.8	73.3	95.7	121.2	149.6
1 1/2	0.2	1.3	2.5	5.1	7.3	11.4	14.6	20.3	31.6	45.6	62.0	81.0	102.5	126.6
2	0.2	1.0	1.9	3.9	5.6	8.7	11.2	15.5	24.2	34.8	47.4	61.9	78.4	96.8

### Maximum Installed Deflections (Both Ends Restrained)

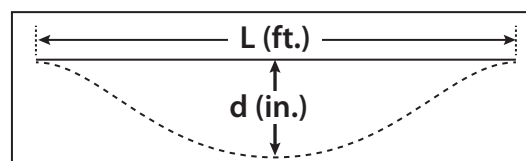



## Flame Spread Index (FSI) and Smoke Developed Index (SDI) Rating for ABS, CPVC, and PVC

The ASTM E 84/UL 723 test protocol is specified by the Uniform and International Mechanical Codes to evaluate a material's suitability for inclusion within unducted return air plenum spaces.

Charlotte Pipe manufactures all of our CPVC CTS pipe and fittings from FlowGuard Gold® CPVC pipe and fittings compounds which are purchased directly from Lubrizol. These are the same compounds used by their other customers/converters to the best of our knowledge. Further, Charlotte Pipe and other converters have provided our customers (contractors, engineers, code officials, and distributors) in the past with copies of the Lubrizol test reports indicating that Lubrizol products conform to ASTM E 84. In this listing (ICC-ES Report PMG-1264), which is available upon request, Lubrizol and ICC Evaluation Service represent that the Lubrizol pipe and fitting systems are plenum compliant. Charlotte Pipe defers to this listing report.

## Flame Spread and Smoke Developed Rating for FlowGuard Gold® CTS CPVC Piping Systems

- FlowGuard Gold® CTS CPVC piping systems are listed and labeled as E84 25/50 Rated for use in plenums per ICC Evaluation Service Report PMG 1264.
- FlowGuard Gold® CTS CPVC piping systems comply with self-extinguishing requirements of ASTM D635.
- FlowGuard Gold® CTS CPVC piping systems meet the V-0 burning class requirements of UL 94.

## Flame Spread and Smoke Developed Rating for ABS

- Per ASTM E 84, ABS **does not** meet the 25/50 flame and smoke requirement for plenum application.

## Flame Spread and Smoke Developed Rating for PVC

- Per ASTM E 84, PVC **does not** meet the 25/50 flame and smoke requirement for plenum application.
- PVC piping systems are self extinguishing and will not support combustion.
- PVC piping systems comply with self extinguishing requirements of ASTM D 635.
- PVC piping systems meet the V-0 burning class requirements of UL 94.

### **NOTICE**

Pipe or fittings may be damaged by contact with products containing incompatible chemicals resulting in property damage or personal injury.

- Verify that paints, thread sealants, lubricants, plasticized PVC products, foam insulations, caulks, leak detectors, insecticides, termiticides, antifreeze solutions, pipe sleeve, firestop materials or other materials are chemically compatible with CPVC.
- Do not use edible oils such as Crisco® for lubricant.
- Read and follow chemical manufacturer's literature before using with piping materials.

## Installation Procedures for ABS, CPVC, and PVC Piping Systems

The following information contains installation and testing procedures. These instructions, however, do not encompass all of the requirements for the design or installation of a piping system.

- Systems should be installed in a good and workmanlike manner consistent with normal industry standards and in conformance with all applicable plumbing, fire and building code requirements.
- Pipe and fitting systems should be used for their intended purpose as defined by local plumbing and building codes and the applicable ASTM standard.
- Follow manufacturers' instructions for all products.

ABS, CPVC, and PVC piping systems may be joined by solvent cementing, with threaded connections, flanges or roll grooving. Detail on each of these joining systems is provided within the following pages. When applicable, Charlotte Pipe recommends socket (solvent cement) joining for ABS, CPVC, and PVC piping systems.

## Cutting, Joint Preparation and Solvent Cement

The tools, cleaner, primer, solvent cement and techniques required to properly join plastic piping systems are dependant upon application, pipe diameter and weather conditions. Charlotte Pipe and Foundry recommends that installers be trained and pass the ASME B 31.3 Bonder Qualification Test.

Please see the Special Considerations section of this manual for additional information.

This installation manual provides direction for the installation of the following piping systems:

- ½" – 2" FlowGuard Gold® CTS CPVC pipe and fitting systems with one step solvent cement.
- ½" – 4" Iron Pipe Size ABS, CPVC, and PVC pipe and fitting systems with two step solvent cement.
- 6" Iron Pipe Size and larger ABS, CPVC, and PVC pipe and fitting systems with two step solvent cement.

### **WARNING**

To reduce the risk of death or serious injury from an explosion, collapse or projectile hazard and to reduce the risk of property damage from a system failure:

- Always follow the warnings and procedures provided in this manual.
- Only use ABS / CPVC / PVC pipe and fitting for the conveyance of fluids as defined within the applicable ASTM standards.
- Never use ABS / CPVC / PVC pipe and fittings for the conveyance of gasses.
- Never use ABS / CPVC / PVC pipe or fittings in structural application or in any load-bearing applications.
- Never strike the pipe or fittings or drive them into the ground or into any other hard substance.

### **WARNING**

Failure to follow **safety precautions** may result in misapplication or improper installation and testing which can cause severe personal injury and / or property damage.

### **WARNING**

To reduce the risk of death, serious injury, or property damage from explosion, never use with compressed air devices such as SPUD GUNS, FLAMETHROWERS, BAIT CANNONS, or COMPRESSED AIR GUNS. Always use only for fluid handling/plumbing applications.

### **NOTICE**

- Using an external heat source to bend ABS, CPVC, or PVC may result in structural damage to pipe and fittings.
- Always make changes in direction with fittings.

## Solvent Cements

Pipe and Fitting System	Diameter (in.)	Solvent Cement Standard	Cement Color (common usage, check local code)	Description	Primer (common usage, check local code)
ABS DWV	1½ - 6	ASTM D 2235	Black	Regular or Medium-Bodied	Not Recommended
ABS Plus® Foam Core Pipe	1½ - 4	ASTM D 2235	Black	Regular or Medium-Bodied	Not Recommended
FlowGuard Gold® CTS CPVC	½ - 2	ASTM F 493	Yellow	Regular-Bodied	Optional
CPVC Sch. 80	½ - 2	ASTM F 493	IPS 714 or Oatey CPVC Heavy Duty Orange	Heavy-Bodied	IPS P-70 or Oatey Industrial Grade
CPVC Sch. 80	2½ - 8	ASTM F 493	IPS 714 or Oatey CPVC Heavy Duty Orange	Heavy-Bodied	IPS P-70 or Oatey Industrial Grade
CPVC Sch. 40 ChemDrain	1¼ - 8	ASTM F 493	ChemDrain Mustard Yellow (Required)	Heavy-Bodied	6" and larger: IPS P-70 or Oatey Industrial Grade required
PVC DWV or Sch. 40 Pressure	½ - 4	ASTM D 2564	Clear	Regular or Medium-Bodied	Required ASTM F 656
PVC DWV or Sch. 40 Pressure	6 - 16	ASTM D 2564	Clear or Grey	Medium or Heavy-Bodied	Required ASTM F 656
PVC Sch. 80	¼ - 2	ASTM D 2564	Grey	Medium or Heavy-Bodied	Required ASTM F 656
PVC Sch. 80	2½ - 16	ASTM D 2564	Grey	Heavy-Bodied	IPS P-70 or Oatey Industrial Grade

**NOTICE:** Aerosol or spray-on type primers/solvent cements are not recommended. The practice of aggressively scouring the pipe and fittings with both primer and solvent cement is an integral part of the joining process. Not working the primer or solvent cement into the pipe or fitting could cause potential system failure or property damage.

### **WARNING**

Primers and cements are extremely flammable and may be explosive. Do not store or use near open flame or elevated temperatures, which may result in injury or death.

- Solvent fumes created during the joining process are heavier than air and may be trapped in newly installed piping systems.
- Ignition of the solvent vapors caused by spark or flame may result in injury or death from explosion or fire.
- Read and obey all manufacturers' warnings and any instructions pertaining to primers and cements.
- Provide adequate ventilation to reduce fire hazard and to minimize inhalation of solvent vapors when working with cements, primers and new piping systems.

## Applicator Types

Nominal Pipe Size (in.)	Applicator Type		
	Dauber	Brush Width (in.)	Swab Length (in.)
¼	A	½	NR
⅜	A	½	NR
½	A	½	NR
¾	A	1	NR
1	A	1	NR
1¼	A	1	NR
1½	A	1 - 1½	NR
2	A	1 - 1½	NR
2½	NR	1½ - 2	NR
3	NR	1½ - 2½	NR
4	NR	2 - 3	3
6	NR	3 - 5	3
8	NR	4 - 6	7
10	NR	6 - 8	7
12	NR	6 - 8	7
14	NR	7 - 8	7
16	NR	8+	8

A = Acceptable

NR = Not Recommended

**NOTICE:** Rollers are not recommended.

## Joint Curing

The joint should not be disturbed until it has initially set. The chart below shows the recommended initial set and cure times for ABS, CPVC, and PVC in iron pipe size diameters as well as for FlowGuard Gold® CTS CPVC.

### Recommended Initial Set Times

Temperature Range	Diameter ½" to 1¼"	Diameter 1½" to 3"	Diameter 4" to 8"	Diameter 10" to 16"
60° - 100° F	15 min	30 min	1 hr	2 hr
40° - 60° F	1 hr	2 hr	4 hr	8 hr
0° - 40° F	3 hr	6 hr	12 hr	24 hr

## NOTICE

A joint should not be pressure tested until it has cured. The exact curing time varies with temperature, humidity, and pipe size. The presence of hot water extends the cure time required for pressure testing. Pressurization prior to joint curing may result in system failure.

### Recommended Curing Time Before Pressure Testing

RELATIVE HUMIDITY 60% or Less*	CURE TIME Diameter ½" to 1¼"		CURE TIME Diameter 1½" to 3"		CURE TIME Diameter 4" to 8"		CURE TIME Diameter 10" to 16"
Temperature Range During Assembly and Cure Periods	Up to 180 psi	Above 180 to 370 psi	Up to 180 psi	Above 180 to 315 psi	Up to 180 psi	Above 180 to 315 psi	Up to 100 psi
60° - 100° F	1 hr	6 hr	2 hr	12 hr	6 hr	24 hr	24 hr
40° - 60° F	2 hr	12 hr	4 hr	24 hr	12 hr	48 hr	48 hr
0° - 40° F	8 hr	48 hr	16 hr	96 hr	48 hr	8 days	8 days

\*For relative humidity above 60%, allow 50% more cure time.

The above data are based on laboratory tests and are intended as guidelines.

For more specific information, contact should be made with the cement manufacturer.

### \*Average number of joints per Quart for Cement and Primer (Source: IPS Weld-on)

Pipe Diameter	½"	¾"	1"	1½"	2"	3"	4"	6"	8"	10"	12"	15"	18"
Number of Joints	300	200	125	90	60	40	30	10	5	2 to 3	1 to 2	¾	½

For Primer: double the number of joints shown for cement.

\* These figures are estimates based on IPS Weld-on laboratory tests.

Due to many variables in the field, these figures should be used as a general guide only.

## FlowGuard Gold® CTS Installation Procedures

### 1. Cut Pipe

- Cut pipe square with the axis. All joints are sealed at the base of the fitting hub. An angled cut may result in joint failure.
- Acceptable tools include ratchet type pipe cutter, miter saw or wheel type pipe cutter. Wheel type pipe cutters must employ a blade designed to cut plastic pipe. Ratchet cutters should be sharpened regularly.
- If any indication of damage or cracking is evident at the tube end, cut off at least 2" of pipe beyond any visible cracks.

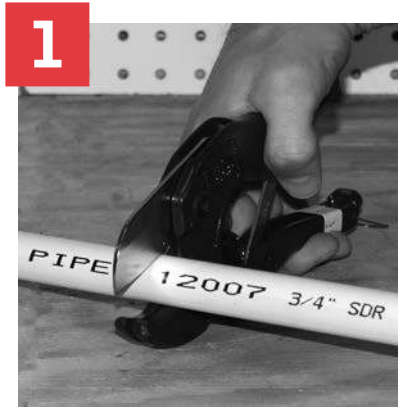

### 2. Remove Burrs and Bevel

- Remove all pipe burrs from inside and outside diameter of pipe with a knife edge, file or de-burring tool.
- Chamfer (bevel) the end of the pipe 10° - 15°.



### 3. Clean and Dry Pipe and Fittings

- Remove surface dirt, grease or moisture with a clean dry cloth.



### 4. Dry Fit

- With light pressure, pipe should go one half to two thirds of the way into the fitting hub. Pipe and fittings that are too tight or too loose should not be used.



### 5. Applicator

- Use an applicator that is one half the size of the pipe's diameter.
- Too large an applicator will force excess primer or cement into the inside of the fitting. Too small an applicator will not apply sufficient cement.



### 6. Coat Surface with Cement

- Stir or shake the cement prior to use.
- Apply a full even layer of cement to the pipe surface to a point 1/2" beyond the hub depth. Aggressively work the cement into the surface.
- Without re-dipping the applicator in the cement, apply a thin layer of cement to the fitting socket aggressively working it into the surface.



# INSTALLATION PROCEDURES

- Do not allow cement to puddle or accumulate inside the system.
- Solvent cement should conform to ASTM F 493 as shown in the accompanying table. All purpose cement is not recommended.
- Primer is not required for FlowGuard Gold® one-step cement, but may be used. Check local code requirements.

## 7. Join Pipe and Fittings



- Assemble pipe and fittings quickly while cement is fluid. If cement has hardened, cut pipe, dispose of fitting and start over.
- Insert pipe into fitting hub giving a quarter turn ensuring an even distribution of cement within the joint.
- Once the pipe contacts the socket bottom hold pipe and fitting together until the pipe does not back out.
- Align all piping system components properly without strain. Do not bend or pull pipe into position after being solvent welded.
- See table for recommended set and cure times.

- Remove excess cement from the exterior. A properly made joint will show a continuous bead of cement around the perimeter. If voids appear sufficient cement may not have been applied and joint failure may result.



## WARNING

Primers and cements are extremely flammable and may be explosive. Do not store or use near open flame or elevated temperatures, which may result in injury or death.

- Solvent fumes created during the joining process are heavier than air and may be trapped in newly installed piping systems.
- Ignition of the solvent vapors caused by spark or flame may result in injury or death from explosion or fire.
- Read and obey all manufacturers' warnings and any instructions pertaining to primers and cements.
- Provide adequate ventilation to reduce fire hazard and to minimize inhalation of solvent vapors when working with cements, primers and new piping systems.



## ABS, CPVC, and PVC Iron Pipe Size Installation Procedures

### 1/2" – 4" Iron Pipe Size ABS, CPVC, and PVC Pipe and Fitting Systems

#### 1. Cut Pipe

- Cut pipe square with the axis. All joints are sealed at the base of the fitting hub. An angled cut may result in joint failure.
- Acceptable tools include ratchet type pipe cutter, miter saw, reciprocating saw, mechanical cut off saw with carbide tipped blade or wheel type pipe cutter. Wheel type pipe cutters must employ a blade designed to cut plastic pipe. Ratchet cutters should be sharpened regularly.
- If any indication of damage or cracking is evident at the pipe end, cut off at least 2" of pipe beyond any visible cracks.



#### 2. Remove Burrs and Bevel

- Remove all pipe burrs from inside and outside diameter of pipe with a knife edge, file or de-burring tool.
- Chamfer (bevel) the end of the pipe 10° - 15°.



#### 3. Clean and Dry Pipe and Fittings

- Remove surface dirt, grease or moisture with a clean dry cloth.



#### 4. Dry Fit

- With light pressure, pipe should go one half to two thirds of the way into the fitting hub. Pipe and fittings that are too tight or too loose should not be used.



#### 5. Applicator

- Use an applicator that is one half the size of the pipe's diameter. Daubers, natural bristle brushes or swabs are recommended. Rollers are not recommended.
- Too large an applicator will force excess primer or cement into the inside of the fitting. Too small an applicator will not apply sufficient cement.

#### 6. Coat Surface with Primer

- Apply primer to the fitting socket aggressively working it into the surface.



- Apply primer to the pipe surface to a point  $\frac{1}{2}$ " beyond the hub depth. Aggressively work the primer into the surface.

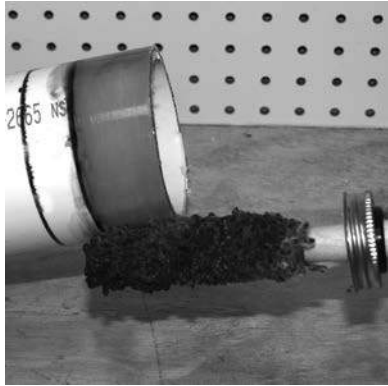

- Apply a second coat of primer to the fitting socket aggressively working it into the surface.



- More applications of primer may be required on hard surfaces or cold weather conditions.
- Once the surface is primed remove all puddles of excess primer from the fitting socket.
- Primer should conform to ASTM F 656.
- The use of primer for ABS is not recommended. Check local code requirements.

## 7. Coat Surface with Cement



- Cement must be applied while primer is wet.
- Stir or shake the cement prior to use.
- Apply a full even layer of cement to the pipe surface to a point  $\frac{1}{2}$ " beyond the hub depth. Aggressively work the cement into the surface.

- Without re-dipping the applicator in the cement, apply a medium layer of cement to the fitting socket aggressively working it into the surface. On bell end pipe do not coat beyond the socket depth.

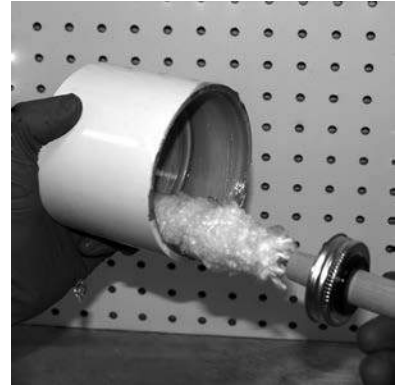

- Apply a second full coat of cement to the pipe surface aggressively working it in.



- Do not allow cement to puddle or accumulate inside the system.
- Solvent cement should conform to the appropriate ASTM standard for the piping system as shown in the accompanying table. All purpose cement is not recommended

## 8. Join Pipe and Fittings

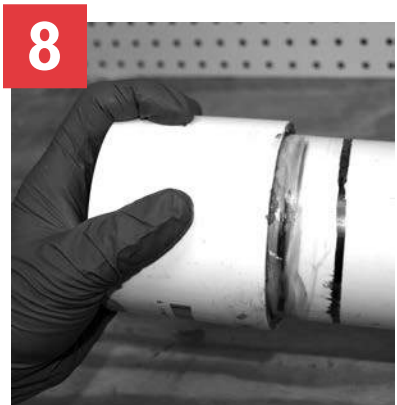

- Assemble pipe and fittings quickly while cement is fluid. If cement has hardened, cut pipe, dispose of fitting and start over.
- Insert pipe into the fitting hub giving a quarter turn as the pipe is being inserted, ensuring an even distribution of the cement within the joint. Do not quarter turn the pipe after contact with socket bottom.
- Once the pipe contacts the socket bottom hold pipe and fitting together until the pipe does not back out.
- See table for recommended set and cure times.



- Remove excess cement from the exterior. A properly made joint will show a continuous bead of cement around the perimeter. If voids appear sufficient cement may not have been applied and joint failure may result.

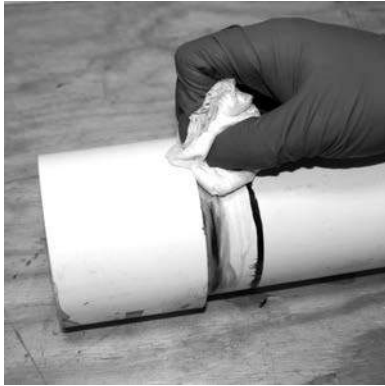

- Align all piping system components properly without strain. Do not bend or pull pipe into position after being solvent welded.



## WARNING

Primers and cements are extremely flammable and may be explosive. Do not store or use near open flame or elevated temperatures, which may result in injury or death.

- Solvent fumes created during the joining process are heavier than air and may be trapped in newly installed piping systems.
- Ignition of the solvent vapors caused by spark or flame may result in injury or death from explosion or fire.
- Read and obey all manufacturers' warnings and any instructions pertaining to primers and cements.
- Provide adequate ventilation to reduce fire hazard and to minimize inhalation of solvent vapors when working with cements, primers and new piping systems.

## ABS, CPVC, and PVC Iron Pipe Size Installation Procedures

### 6" and Larger Iron Pipe Size ABS, CPVC, and PVC Pipe and Fitting Systems

Joining larger diameter piping systems, particularly for pressure applications, requires a higher degree of skill. Proper installation technique is critical. Close attention to the steps below will help professional mechanics to complete successful installations.

#### 1. Cut Pipe

- Cut pipe square with the axis. All joints are sealed at the base of the fitting hub. An angled cut may result in joint failure.
- Acceptable tools include reciprocating saw, mechanical cut off saw with carbide tipped blade or other appropriate tool.
- If any indication of damage or cracking is evident at the (tube / pipe) end, cut off at least 2" of pipe beyond any visible cracks.



#### 2. Remove Burrs and Bevel

- Remove all pipe burrs from inside and outside diameter of pipe with a de-burring tool.
- Chamfer (bevel) the end of the pipe 10° - 15°. Powered and manual chamfering tools are available.



#### 3. Clean and Dry Pipe and Fittings

- Remove surface dirt, grease or moisture with a clean dry cloth.



#### 4. Mark Insertion Depth

- Measure the fitting hub depth. Using a pipe wrap as a straight edge mark the insertion depth plus 2" in a heavy continuous line around the circumference of the pipe.



#### 5. Dry Fit

- With light pressure, pipe should go one half to two thirds of the way into the fitting hub. Pipe and fittings that are too tight or too loose should not be used.



#### 6. Applicator

- Use an applicator that is one half the size of the pipe's diameter. Use of an appropriately sized applicator will ensure that adequate cement is applied. Natural bristle brushes or swabs are recommended. Rollers are not recommended.
- Too small an applicator will not apply sufficient cement.

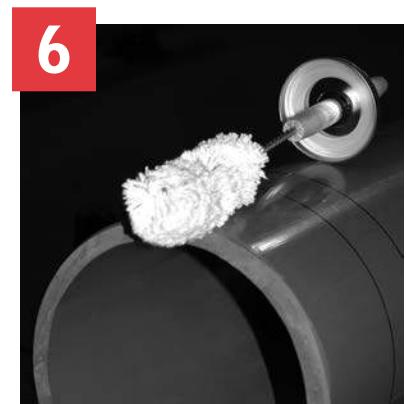

## 7. Crew Size

- Working rapidly, especially in adverse weather conditions, will improve installations. For 6" to 8" diameters a crew size of 2 to 3 mechanics is required. For 10" pipe diameters and larger a crew of 3 to 4 mechanics may be required.

## 8. Coat Surface with Primer

- Apply primer to the fitting socket aggressively working it into the surface.



- Apply primer to the pipe surface to a point 1/2" beyond the hub depth. Aggressively work the primer into the surface.



- Apply a second coat of primer to the fitting socket aggressively working it into the surface.



- More applications of primer may be required on hard surfaces or cold weather conditions.

- NOTICE:** Pipe diameters 6" and larger must be installed using IPS P-70 or Oatey Industrial Grade primers.

## WARNING

Primers and cements are extremely flammable and may be explosive. Do not store or use near open flame or elevated temperatures, which may result in injury or death.

- Solvent fumes created during the joining process are heavier than air and may be trapped in newly installed piping systems.
- Ignition of the solvent vapors caused by spark or flame may result in injury or death from explosion or fire.
- Read and obey all manufacturers' warnings and any instructions pertaining to primers and cements.
- Provide adequate ventilation to reduce fire hazard and to minimize inhalation of solvent vapors when working with cements, primers and new piping systems.

- Once the surface is primed remove all puddles of excess primer from the fitting socket.
- The use of primer for ABS is not recommended. Check local code requirements.

## 9. Coat Surface with Cement

- Cement must be applied while primer is wet. It is ideal if one mechanic applies the primer while a second immediately applies the cement.

- Stir or shake the cement prior to use.

- Apply a full even layer of cement to the pipe surface to a point 1/2" beyond the hub depth. Aggressively work the cement into the surface.

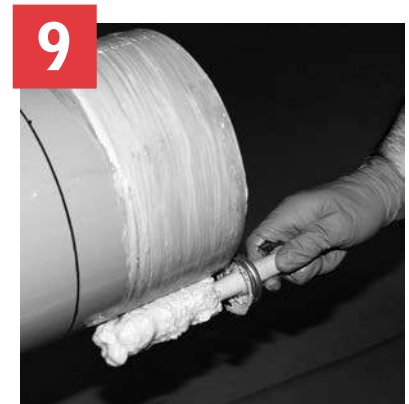

- Apply a medium layer of cement to the fitting socket aggressively working it into the surface. On bell end pipe do not coat beyond the socket depth.



- Apply a second full coat of cement to the pipe surface aggressively working it in.

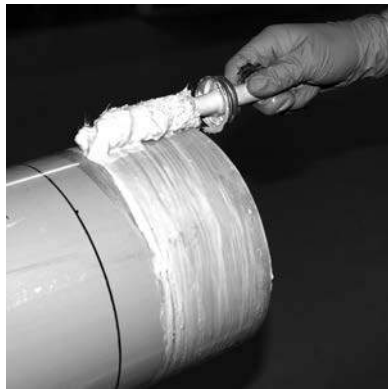

- Do not allow cement to puddle or accumulate inside the system.

- Solvent cement should conform to the appropriate ASTM standard for the piping system as shown in the accompanying table. Heavy bodied cement is recommended. All purpose cement is not recommended

- **NOTICE:** CPVC Schedule 80 systems must be installed using IPS 714 or Oatey CPVC Heavy Duty Orange solvent cements.

## 10. Join Pipe and Fittings

- Assemble pipe and fittings quickly while cement is fluid. If cement has hardened, cut pipe, dispose of fitting and start over.

- It is very important that the pipe is fully inserted to the fitting stop at the bottom of the fitting. Large diameter pipe is heavy and can develop significant resistance during insertion. The use of a pulling tool designed for plastic piping systems is recommended.



10

## CAUTION

Failure to follow proper installation practices, procedures, or techniques may result in personal injury, system failure or property damage.

- Use a solvent cement / primer applicator that is 1/2 the size of the pipe's diameter. Too large an applicator will result in excess cement inside the fitting. Too small an applicator will not apply sufficient cement.
- Cut pipe square.
- Do not use dull or broken cutting tool blades when cutting pipe.
- Do not test until recommended cure times are met.
- Align all piping system components properly without strain. Do not bend or pull pipe into position after being solvent welded.

- Measure to verify that the pipe has been inserted to within 2" of the insertion line.

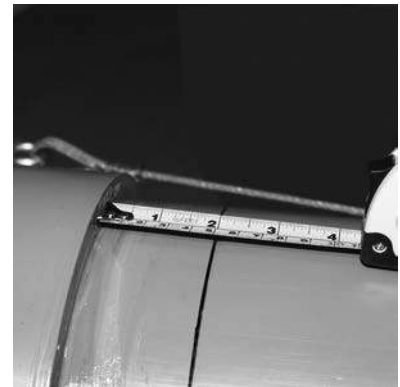

- To ensure joint integrity, once insertion is complete, the pulling tool can be used to hold the joint in place during set time and also to ensure that the pipe does not back out.



- See table for recommended set and cure times.

- Remove excess cement from the exterior. A properly made joint will show a continuous bead of cement around the perimeter. If voids appear sufficient, cement may not have been applied and joint failure may result.
- Align all piping system components properly without strain. Do not bend or pull pipe into position after being solvent welded.



## **! WARNING**

Primers and cements are extremely flammable and may be explosive. Do not store or use near open flame or elevated temperatures, which may result in injury or death.

- Solvent fumes created during the joining process are heavier than air and may be trapped in newly installed piping systems.
- Ignition of the solvent vapors caused by spark or flame may result in injury or death from explosion or fire.
- Read and obey all manufacturers' warnings and any instructions pertaining to primers and cements.
- Provide adequate ventilation to reduce fire hazard and to minimize inhalation of solvent vapors when working with cements, primers and new piping systems.

## Repairs or Modifications to Existing ABS, CPVC, or PVC Systems

It is important to note that the chemical properties of all thermoplastic materials change over time. Visually, this often means that the pipe may experience color variations. In CTS CPVC applications the temperature of the water running through the pipe often determines the degree of variation, with hot water causing a more noticeable change. Exposure to ultraviolet (UV) light may also cause the exposed surface of PVC or CPVC to brown. Purple PVC, purple CPVC or ABS pipe tend to fade with UV exposure (please see **Weathering / UV Exposure** for additional information). Color variations do not indicate that the pressure carrying capabilities of the pipe have been compromised. In fact, the pressure carrying capability of thermoplastic pipe increases as the pipe ages.

What also changes over time is the impact resistance of ABS, CPVC, and PVC piping systems, which has little effect upon installed systems. It does mean, however, that if a cut-in is necessary, additional care should be taken to prevent damaging the existing system. This is typically a greater issue with thin-wall, smaller-diameter piping systems such as CTS CPVC, PVC PR 200, PVC PR 160 or Schedule 40 PVC. Ratchet cutters may compress the pipe and cause end cracks on aged pipe. Even if the cracks are not visible, they can eventually propagate through the fitting and cause a leak.

Charlotte Pipe recommends using a fine-tooth saw when performing cut-in operations. Once the pipe is cut, continue with standard installation procedures. Keep in mind that if the area is wet, additional cure time is required and may be three times as long. The inside and outside diameter of pipe and fittings should be kept as dry as possible.



## Repair Coupling Installation Not for Pressure Applications

1. Cut out the segment of pipe to be replaced.

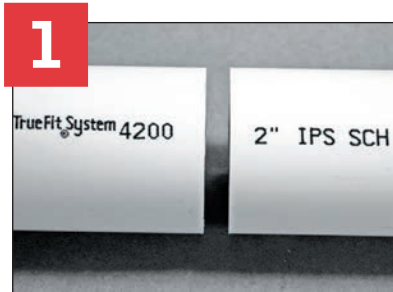

2. Remove all pipe burrs from inside and outside diameter of pipe with a knife edge, file or de-burring tool.



Chamfer (bevel) the end of the pipe  $10^{\circ}$  -  $15^{\circ}$ .



3. Position the repair coupling so that half of its length is equally divided between the two pipe ends. Mark each pipe end using the repair as a length guide.



4. Place the repair coupling on the pipe with the larger pipe ID (inside diameter) end facing the gap between the pipe ends.



5. Apply primer between the mark and pipe end on both pipe ends. Note: The use of primer for ABS is not recommended. Check local code requirements.



6. Apply heavy body cement (if using PVC) and apply medium body cement (if using ABS) between the mark and pipe end on both pipe ends.



7. Push the repair coupling toward the gap until you reach the mark on the other pipe end. A bead of cement will be present around the entire diameter of the pipe and coupling.



## ConnecTite Installation Procedures

### 1-1/2" - 3" Iron Pipe Size Pipe and Fitting Systems

#### 1. Cut Pipe

- Cut pipe square with the axis. An angled cut may result in joint failure.
- Acceptable tools include ratchet type pipe cutter, miter saw, reciprocating saw, mechanical cut off saw with carbide tipped blade or wheel type pipe cutter. Wheel type pipe cutters must employ a blade designed to cut plastic pipe. Ratchet cutters should be sharpened regularly.
- If any indication of damage or cracking is evident at the pipe end, cut off at least 2" of pipe beyond any visible cracks.



#### 2. Remove Burrs and Sand

- Remove all pipe burrs from inside and outside diameter of pipe with a knife edge, file or deburring tool.
- Sand outside corner of pipe around entire diameter using sanding sponge for a minimum of 20 seconds.



#### 3. Clean and Dry Pipe

- Remove surface dirt, grease or moisture with a clean dry cloth.



#### 4. Mark

- Mark pipe with a minimum insertion line. This is determined by pipe diameter.

Pipe Size	Mark
1½"	¾"
2"	1"
3"	1¼"



#### 5. Lubricate

- Apply a silicone based lubricant or liquid dish soap to both the pipe and the gasket.





## 6. Initial Insert and Alignment

6

- Gently insert pipe into fitting hub until you feel resistance from the rubber gasket.
- Stop and check to ensure pipe is properly aligned with fitting hub.



- To disconnect, simultaneously twist and pull pipe and/or fitting until pipe is removed from the ConnectTite fitting
- Check to ensure rubber gasket and metal lock ring are not damaged or out of place



- NOTE: Misalignment can cause damage



- Reuse a maximum of three times
- Use clean pipe end; scratches on pipe can cause leaks



## 7. Fully Insert, Twist, and Align

7

- Fully insert pipe into fitting hub, applying steady force and twist pipe and/or fitting until the minimum insertion mark is no longer visible and you cannot insert pipe any further.



- Align by twisting the fitting to desired alignment; check to ensure pipe is fully inserted



## Installation of Brass and CPVC Threaded Fittings

The following chart shows the correct amount of tape and torque required to make a properly functioning assembly.

Pipe Size	Torque Setting		Teflon Tape
	Brass Threaded Fittings	CPVC Threaded Fittings	
½"	14 ft.lbs.	3 to 5 ft.lbs.	½" width
¾"	18 ft.lbs.	4 to 6 ft.lbs.	½" width
1"	24 ft.lbs.	5 to 7 ft.lbs.	½" width
1¼"	30 to 60 ft.lbs.	5 to 7 ft.lbs.	
1½"	23 to 34 ft.lbs.	6 to 8 ft.lbs.	
2"	36 to 50 ft.lbs.	8 to 10 ft.lbs.	

Note: 1 foot pound = 12 inch pounds

## NOTICE

Use of FlowGuard Gold® CTS CPVC all-plastic threaded male adapters in hot water applications may result in system failure and property damage.

- Use plastic threaded CTS CPVC male adapters in cold water applications only.
- Use CTS CPVC x brass threaded transition fittings for hot water applications.
- Do not use compression fittings with brass ferrules to connect to CTS CPVC pipe or fittings where water temperatures will exceed 140 degrees F.
- CPVC pipe can be used with standard brass ferrules to make compression connections where the operating temperature will not exceed 140°F. Apply Teflon (PTFE) tape over the ferrule to allow for the dissimilar thermal expansion and contraction characteristics of the metal ferrule and the plastic pipe.

## WARNING

Testing with or use of compressed air or gas in ABS / CPVC / PVC pipe or fittings can result in explosive failures and cause severe injury or death.

AIR/GAS



- NEVER test with or transport/store compressed air or gas in ABS / CPVC / PVC pipe or fittings.
- NEVER test ABS / CPVC / PVC pipe or fittings with compressed air or gas, or air over water boosters.
- ONLY use ABS / CPVC / PVC pipe or fittings for water or approved chemicals.
- Refer to warnings on PPFA's website and ASTM D 1785.

## Installation of ABS, CPVC, and PVC Threaded Connections without O-rings

### Diameters 1 inch or Smaller

1. Make sure the threads are clean.
2. Charlotte Pipe recommends Teflon® tape thread sealant for threaded connections 1-inch or smaller. Use a good quality Teflon tape which has .4 minimum density, .003" thick, .50% elongation and chemically inert. Wrap the Teflon tape around the entire length of the threads; start with two wraps at the end and wrap all threads overlapping half the width of the tape. Wrap in the direction of the threads on each wind.
3. Maximum wrench-tightness is two turns past finger tight. Tighten with a strap wrench or similar tool. Do not use common wrenches or tools designed for metallic pipe systems.

## NOTICE

All pipe thread sealants must conform to the requirements of IAPMO's PS 36 and with the thread sealant manufacturer to confirm that these sealants are chemically compatible with ABS, CPVC, and PVC. Incompatible pipe thread sealants may result in the degradation of plastic pipe or fittings resulting in product failure and property damage.

- Verify that paints, thread sealants, lubricants, plasticized PVC products, foam insulations, caulks, leak detectors, insecticides, termiticides, antifreeze solutions, pipe sleeve, firestop materials or other materials are chemically compatible with ABS, CPVC, or PVC.
- Do not use edible oils such as Crisco® for lubricant.
- Read and follow chemical manufacturer's literature before using with piping materials.
- Confirm compatibility of pipe marking adhesive tape with the manufacturer of the tape to ensure chemical compatibility with CPVC pipe and fittings.

### Diameters 1-1/4 inch or Larger

1. Make sure the threads are clean.
2. Charlotte Pipe recommends paste type non-hardening thread sealant for threaded connections 1-1/4 inch or larger. All thread sealants must conform to the requirements of IAPMO PS 36 and NSF Standard 61. Chemical compatibility of joint compounds and thread sealants with ABS, CPVC, and PVC should be verified with the thread sealant manufacturer.

3. Maximum wrench-tightness is two turns past finger tight. Tighten with a strap wrench or similar tool. Do not use common wrenches or tools designed for metallic pipe systems.

**NOTICE:** All pipe thread sealants must conform to the requirements of IAPMO PS 36 and with the thread sealant manufacturer to confirm that these sealants are chemically compatible with ABS, CPVC, and PVC. Incompatible pipe thread sealants may result in the degradation of plastic pipe or fittings resulting in product failure and property damage.

## NOTICE

Exceeding recommended torque for threaded connections may result in component damage, system failure and property damage.

## Installation of threaded Connections with O-ring Plugs

**NOTICE:** To reduce the risk of property damage from leakage, never use thread sealants, pastes, tapes or lubricants with fittings and/or plugs supplied with an O-ring. They may contain chemicals that damage the O-ring.

1. These procedures only apply to plugs supplied with an O-ring.
2. Using a clean cloth, make sure the threads of the mating part, the plug threads, all sealing surfaces and the O-ring are clean.
3. Tighten plug until finger tight. At this point, a gap between the O-ring and the top edge of the sealing surface should not be present.
4. Maximum wrench-tightness is ½ turn past finger tight. Tighten with a strap wrench or similar tool. Do not use common wrenches or tools designed for metallic pipe systems.

## WARNING

Pipe or fittings may be damaged by contact with products containing incompatible chemicals resulting in personal injury or property damage.

- Verify that paints, thread sealants, lubricants, plasticized PVC products, foam insulations, caulks, leak detectors, insecticides, termiticides, antifreeze solutions, pipe sleeve, firestop materials or other materials are chemically compatible with ABS, CPVC, and PVC.
- Do not use edible oils such as Crisco® for lubricant.
- Read and follow chemical manufacturer's literature before using with piping materials.

## Flanges

For systems where dismantling is required, flanging is a convenient joining method. It is also an easy way to join plastic and metallic systems.

### Installation

1. Join the flange to the pipe using the procedures shown in the solvent cementing or threading sections. Due to the tensile stresses placed on the solvent cement joint for flange connections, double the recommended curing time before joint assembly and pressure testing.
2. Use a full faced elastomeric gasket which is resistant to the chemicals being conveyed in the piping system. A gasket  $\frac{1}{8}$ " thick with a Durometer, scale "A", hardness of 55 -80 is normally satisfactory.
3. Align the flanges and gasket by inserting all of the bolts through the mating flange bolt holes. Be sure to use properly sized flat washers under all bolt heads and nuts.
4. Sequentially tighten the bolts using a torque wrench, corresponding to the patterns shown below in increments of 10 ft-lbs at a time up to the recommended torque. New bolts and nuts should be used for proper torque.
5. Tighten flanges only to maximum recommended torque limits; do not tighten bolts in such a manner as to cause the flange ring to bend or be under stress. Connect to full face flanges or valves that conform to ANSI B16.5 150 pound dimensions and that provide full support under the entire flange face.

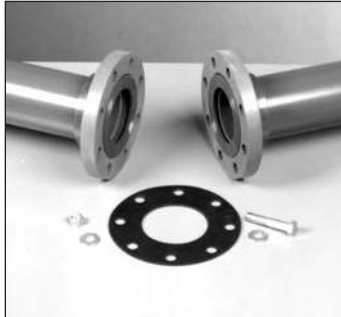

6. Use a torque wrench to tighten the bolts to the torque values shown below.
7. Use of thread lubricant will ensure proper torque. Confirm that the thread lubricant is chemically compatible with pipe and fittings.
8. When installing flanges in a buried application where settling could occur, the flange must be supported to maintain proper alignment in service.

### Recommended Torque

Pipe Size In Inches	No. Bolt Holes	Bolt Diameter	Recommended Torque ft-lbs
$\frac{1}{2}$	4	$\frac{1}{2}$	10 - 15
$\frac{3}{4}$	4	$\frac{1}{2}$	10 - 15
1	4	$\frac{1}{2}$	10 - 15
$1\frac{1}{4}$	4	$\frac{1}{2}$	10 - 15
$1\frac{1}{2}$	4	$\frac{1}{2}$	10 - 15
2	4	$\frac{5}{8}$	20 - 30
$2\frac{1}{2}$	4	$\frac{5}{8}$	20 - 30
3	4	$\frac{5}{8}$	20 - 30
4	8	$\frac{5}{8}$	20 - 30
6	8	$\frac{3}{4}$	33 - 50
8	8	$\frac{3}{4}$	33 - 50
10	12	$\frac{7}{8}$	53 - 65
12	12	$\frac{7}{8}$	53 - 75

Note: Flanges meet the bolt-pattern requirements of ANSI / ASME B 16.5

### Flange Tightening Sequence

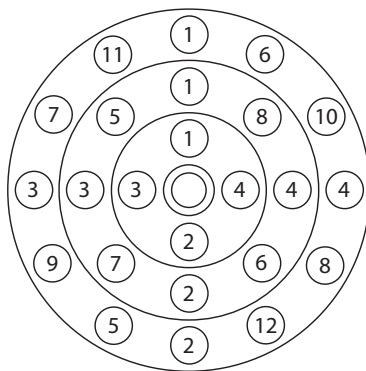

## NOTICE

- Exceeding recommended flange bolt torque may result in component damage, system failure and property damage.
- Use the proper bolt tightening sequence as marked on the flange.
- Make sure the system is in proper alignment.
- Flanges may not be used to draw piping assemblies together.
- Flat washers must be used under every nut and bolt head.
- Connect to full face flanges or valves that conform to ANSI B16.5 150 pound dimensions and that provide full support under the entire flange face.
- Exceeding recommended pressure rating and/or temperature ratings may result in component damage, system failure and property damage.
- Ensure that thread lubricant is chemically compatible with pipe and fittings.
- Piping systems differ in chemical resistance. Pipe or fittings may be damaged by contact with products containing incompatible chemicals resulting in system failure and/or property damage.
- Corrosion resistant bolts, nuts, and flat washers are recommended in chemical applications.

For information on the pressure ratings of PVC and CPVC flanges please refer to the pressure rating of fittings, flanges, and union sections in the design and engineering section of this manual.

## Unions

A union fitting permits easy disconnection of a piping system for replacement or repair in the line. Union fittings consist of three separate parts that when installed properly join two sections of pipe together.

Installing the union threaded piece and union piece socket end should be done in accordance with the solvent cementing instructions provided in this manual. Care should be taken so that solvent cement does not come into contact with the union threads or the union face. **Note:** It is important to remember

to place the union shoulder piece on the pipe prior to solvent cementing to the pipe. Thread or solvent cement the union threaded piece to the pipe. The joint should not be disturbed until it has initially set. Once the joints have properly cured, ensure that the two mating pieces are flush to one another prior to tightening the union ring. The ring should not draw piping systems together or correct improper alignment of the system. The ring should be hand tightened or tightened with a strap wrench only.

### NOTICE

**Do not exceed the maximum working pressure of any system components including pipe, fittings, valves, molded or cut threads, unions, mechanical coupling or flanges.**

- The pressure rating of all components must be reduced at temperatures above 73 degrees F. Refer to de-rating table in this manual.
- Exceeding the maximum working temperature or pressure of the system may result in system failure and property damage.

### NOTICE

**Unions may be damaged by contact with products containing incompatible chemicals resulting in property damage or personal injury.**

- Do not use lubricants or thread sealants on the union nuts.
- Never use common wrenches or tools designed for metallic pipe systems. Only use strap wrenches.
- Unions may not be used to draw piping assemblies together.
- Exceeding recommended pressure rating and/or temperature rating may result in component damage, system failure and property damage.

### ! WARNING

**Testing with or use of compressed air or gas in ABS / CPVC / PVC pipe or fittings can result in explosive failures and cause severe injury or death.**

AIR/GAS



- NEVER test with or transport/store compressed air or gas in ABS / CPVC / PVC pipe or fittings.
- NEVER test ABS / CPVC / PVC pipe or fittings with compressed air or gas, or air over water boosters.
- ONLY use ABS / CPVC / PVC pipe or fittings for water or approved chemicals.
- Refer to warnings on PPFA's website and ASTM D 1785.

For information on the pressure ratings of PVC and CPVC schedule 80 unions please refer to the pressure rating of fittings, flanges, and union sections in the design and engineering section of this manual.

## Procedure for Cutting Threads in Schedule 80 Pipe

### 1. Cutting

The pipe must be cut square using a power saw, a miter box, or a plastic pipe cutter. Burrs should be removed using a knife or deburring tool.

### 2. Threading

Threads can be cut using either hand held or power threading equipment. The cutting dies should be clean, sharp, and in good condition. Special dies for cutting plastic pipe are available and are recommended.

When using a hand threader, the dies should have a 5° to 10° negative front rake. When using a power threader, the dies should have a 5° negative front rake and the die heads should be self-opening. A slight chamfer to lead the dies will speed production. However, the dies should not be driven at high speeds or with heavy pressure.

When using a hand held threader, the pipe should be held in a pipe vise. To prevent crushing or scoring of the pipe, a protective wrap such as emery paper, canvas, rubber, or a light metal sleeve should be used.

Insert a tapered plug into the end of the pipe to be threaded. This plug will provide additional support and prevent distortion of the pipe in the threading area.

It is recommended that a water soluble machine oil, chemically compatible with PVC and CPVC, be used during the threading operation. Also, clearing the cuttings from the die is highly recommended.

Do not over-thread the pipe. Consult the diagram and table showing ASTM F 1498 dimensions for American Standard Taper pipe threads. Periodically check the threads with a ring gauge to ensure that the threads are accurate. The tolerance is  $\pm 1\frac{1}{2}$  turns.

\*Trademark of the E.I. DuPont Company



**NOTE:** Threading of PVC Schedule 40 and CPVC Schedule 80 pipe is not recommended. Threading pipe over 4" in diameter is not recommended.



## Joining Roll-Grooved Pipe

Roll-grooved PVC pipe is designed for use with conventional gasketed mechanical couplings. It offers a method of joining which is quick and convenient, and it can be used in applications where frequent assembly and disassembly are desirable.

### Installation

1. Consult with the manufacturer of the couplings for recommendations on the coupling style(s) designed for use with PVC pipe and the gasket material which is suitable for the intended service.



2. Check the pipe ends for any damage, roll marks, projections, or indentations on the outside surface between the groove and the end of the pipe. This is the sealing area, and it must be free of any defects.
3. Disassemble the coupling and remove the gasket. Inspect for any damage and make sure the gasket material is suitable for the intended service. Apply a thin coat of silicone lubricant to the gasket tips and the outside of the gasket.
4. Slide the gasket onto the end of one length of pipe so that it is flush with the end. Align and bring the end of another length of pipe together while sliding the gasket back over this junction. The gasket should be centered between the grooves and should not extend into the groove on either length of pipe.
5. Place the coupling housings over the gasket. The housing keys should engage into the grooves. Insert the bolts and apply the nuts. Tighten to "finger tight."

6. Using a wrench, alternately tighten the nuts to the coupling manufacturer's specifications. Over tightening is not necessary, and uneven tightening may cause gasket pinching.



## Gasketed Pipe Assembly\*

Bar and block is the recommended method of assembly. Small-diameter pipes can be assembled by one worker, while larger diameters may require two people working together.

Besides quicker installation of a pipe line, the major advantage of barring pipe (see Bar & Block illustration below) is that the worker has a feel for the process. This assures proper alignment and assembly.

**NOTE:** Assembly with power equipment is not recommended.

Standard good mechanical assembly practice take alignment into consideration and produces reliable, leak-free pipe lines.

Straight alignment assembly will not dislodge gaskets. Forced, improper alignment insertion produces an insertion curve characterized by the tremendous force necessary to dislodge the gasket from the race, trap it between the bell and spigot surfaces, and stretch it backwards. The insertion force necessary to assemble a joint with dislodged gaskets is so extreme, it can only be accomplished using mechanical equipment without the operator's knowledge of the dislocation.

### Joint Insertion Instructions

1. Clean the gasket area. Remove sand, dirt, grease, and debris. Do not remove gaskets from bells.
2. Check the gasket. Make sure it is seated uniformly in the groove by running your finger around the inner edge of the gasket. If the gasket has a plastic retainer ring, make sure it's properly seated into the rubber portion of the gasket.
3. Clean the spigot. Use a rag to wipe the spigot clean.
4. Lower the pipe into the trench carefully to avoid getting dirt onto the bell or spigot.
5. Lubricate. Apply approved pipe lubricant to the bevel of the spigot end and approximately mid-way back to the reference line. A thin layer of lubricant may be applied to the face of the gasket, but be careful not to get lubricant behind or under the gasket.
6. Keep lubricated areas clean. If dirt or sand adheres to lubricated areas, clean and re-lubricate.



7. Assemble pipe. Insert the spigot end into the pipe until it contacts the gasket uniformly or is a short distance from the gasket. Straight alignment is essential. Apply steady pressure by hand or by mechanical means (bar and block, come-along, hydraulic jack) until the spigot slips through the gasket. Insert pipe until the assembly stop line is flush with the bell end.
8. If undue resistance to pipe insertion is encountered or if the pipe cannot be inserted to the reference mark, disassemble the joint and check the position of the gasket. If the gasket is still properly positioned, verify proper positioning of the reference mark. Relocate the mark if it is not correctly positioned. In general, fittings allow less insertion than do pipe bells.
9. If the pipe must be field-cut, mark the entire circumference to ensure a square cut. Bevel the field cut the same as a factory bevel. If being installed into fittings, follow manufacturer's recommendations. Round off any sharp edges on the leading edge of the bevel with a pocket knife or a file. Mark cut end with an insertion line similar to uncut pipe.

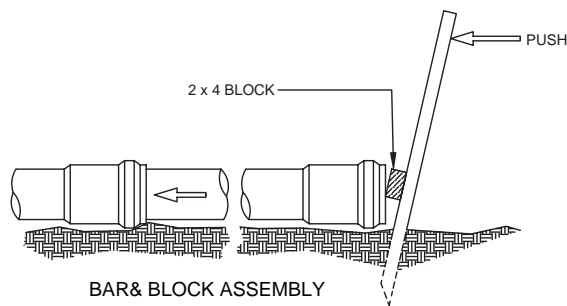

\*Data and language courtesy of Hultec

## Underground Installation of Plastic Pipe

Plastic pipe should always be buried in strict accordance with the ASTM standard relevant to the type of plastic piping system being installed. Those standards are:

- |            |   |
|------------|---|
| ASTM D2321 | Standard practice for Underground Installation of Thermoplastic Pipe for Sewers and other Gravity-Flow Applications |
| ASTM D2774 | Standard Practice for Underground Installation of Thermoplastic Pressure Piping                                     |
| ASTM F1668 | Standard Guide for Construction Procedures for Buried Plastic Pipe  |

**Note:** In addition to these standards, pipe should always be installed in accordance with all local code requirements.

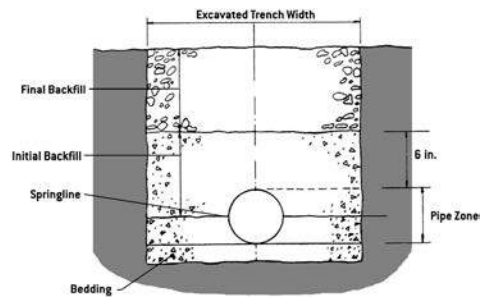

### Recommendations for underground installation of plastic drainage pipe:

1. The minimum width of the trench should be the pipe OD (outside diameter) plus 16 inches, or the pipe outside diameter times 1.25 plus 12 inches. This will allow adequate room for joining the pipe, snaking the pipe in the trench to allow for expansion and contraction where appropriate, and space for backfilling and compaction of backfill. The space between the pipe and trench wall must be wider than the compaction equipment used to compact the backfill.
2. Provide a minimum of 4 inches of firm, stable and uniform bedding material in the trench bottom. If rock or unyielding material is encountered, a minimum of 6 inches of bedding shall be used. Blocking should not be used to change pipe grade or to intermittently support pipe over low sections in the trench.

3. The pipe should be surrounded with an aggregate material which can be easily worked around the sides of the pipe. Backfilling should be performed in layers of 6 inches with each layer being sufficiently compacted to 85% to 95% compaction.
4. A mechanical tamper is recommended for compacting sand and gravel. These materials contain fine-grains such as silt and clay. If a tamper is not available, compacting should be done by hand.
5. The trench should be completely filled. The backfill should be placed and spread in uniform layers to prevent any unfilled spaces or voids. Large rocks, stones, frozen clods, or other large debris should be removed. Stone backfill shall pass through an 1-1/2" sieve. Heavy tampers or rolling equipment should only be used to consolidate the final backfill.
6. To prevent damage to the pipe and disturbance to pipe embedment, a minimum depth of backfill above the pipe should be maintained. Pipe should always be installed below the frost level. Typically, it is not advisable to allow vehicular traffic or heavy construction equipment to traverse the pipe trench.

**Note:** This section is a general reference guide and should not be considered a complete engineering resource addressing all aspects of design and installation of pipe in buried applications. Charlotte Pipe recommends that a design professional use this manual along with other industry references, taking into account sub-surface conditions unique to each project, and that all installations be made in accordance with the requirements found in ASTM D 2321 and in compliance with applicable code requirements.

## Unstable Soil

Burial of pipe under slab in soils that are unstable is often accomplished by suspending the piping systems from structural slabs. The use of plastic pipe in such installations must be in accordance with ASTM F 2536. Cellular core pipe is specifically not permitted for these applications.

When unstable soil requires the drain and waste line to be supported with hangers attached to the concrete slab, sway bracing should always be a part of the support system. Sway bracing will help keep the system in proper alignment and help eliminate movement from side to side.

## CTS CPVC Under-Slab Installations

FlowGuard Gold® CPVC is suitable for under-slab installations when approved by prevailing plumbing and building codes.

When performing under-slab installations, it is important that the pipe be evenly supported. Charlotte Pipe recommends pressure testing with water prior to backfilling and pouring the slab. Backfill should be clean earth, sand, gravel or other approved material, which must not contain stones, boulders or other materials that may damage or break the piping. The pipe should be protected from damage by tools and equipment used to finish the concrete. Because CPVC does not react to concrete or stucco and is inert to acidic soil conditions, it does not need to be sleeved. **NOTE:** Some code jurisdictions require sleeving at slab penetrations. Verify code requirements prior to installation.

Do not bend FlowGuard Gold® 1/2" and 3/4" pipe in a radius tighter than 18"; 1" pipe should not be bent in a radius tighter than 24".

Check applicable plumbing and building codes before making under-slab installations.

## In-Slab Installations

CPVC is not suitable for in-slab radiant heating systems.

ABS, CPVC, and PVC piping can be installed embedded in a concrete slab, because ABS, CPVC, and PVC do not react to concrete or stucco and it is inert to acidic soil conditions. Care must be taken to properly support any piping system when pouring concrete so that the weight of the concrete does not affect the pipe system and that any heat generated by curing concrete does not exceed the capability of the system.

Some codes require sleeving or protection of piping at slab penetrations. While not necessary due to any corrosion issues, always follow applicable code requirements on any installation.

## Testing and Inspection

### **WARNING**

In any test, proper safety procedures and equipment should be used, including personal protective equipment such as protective eyewear and clothing. Installers should always consider local conditions, codes and regulations, manufacturer's installation instructions, and architects'/engineers' specifications in any installation.

Once the roughing-in is completed on a plastic piping system, it is important to test and inspect all piping for leaks. Concealed work should remain uncovered until the required test is made and approved. When testing, the system should be properly restrained at all bends, changes of direction, and the end of runs.

There are various types of procedures used for testing installed plastic systems. However, a water or hydrostatic test is a technically superior test method for inspecting a completed plastic piping system installation and is the testing procedure recommended by Charlotte Pipe. It is also the most recommended test in most plumbing code standards. The purpose of the test is to locate any leaks at the joints and correct them prior to putting the system into operation. Since it is important to be able to visually inspect the joints, a water test should be conducted prior to closing in the piping or backfilling of underground piping.

## Testing DWV System

### Water Test

The system should be properly restrained at all bends, changes of direction, and the end of runs. To isolate each floor or section being tested, test plugs are inserted through test tees in the stack. All other openings should be plugged. The system should be properly restrained at all bends, changes of direction, and the end of runs. To isolate each floor or section being tested, test plugs are inserted through test tees in the stack. All other openings should be plugged or capped with test plugs or test caps.

When testing Foam Core pipe, always use external caps to eliminate the possibility of leakage through the foam core layer of the pipe.

Fill the system to be tested with water at the highest point. As water fills a vertical pipe it creates hydrostatic pressure. The pressure increases as the height of the water in the vertical pipe increases. Charlotte Pipe recommends testing at 10 feet of hydrostatic pressure (4.3 pounds per square inch.) Filling the system slowly should allow any air in the system to escape as the water rises in the vertical pipe. All entrapped air in the system should be expelled prior to the beginning of the test. Failure to remove entrapped air may give faulty test results.

Once the stack is filled to "ten feet of head," a visual inspection of the section being tested should be made to check for leaks. If a leak is found, the joint must be cut out and a new section installed. Once the system has been successfully tested, it should be drained and the next section prepared for testing.

### **WARNING**

**Testing with or use of compressed air or gas in ABS / CPVC / PVC pipe or fittings can result in explosive failures and cause severe injury or death.**

AIR/GAS



- NEVER test with or transport/store compressed air or gas in ABS / CPVC / PVC pipe or fittings.
- NEVER test ABS / CPVC / PVC pipe or fittings with compressed air or gas, or air over water boosters.
- ONLY use ABS / CPVC / PVC pipe or fittings for water or approved chemicals.
- Refer to warnings on PPFA's website and ASTM D 1785.

## Alternate Test Methods

### Vacuum Test

Charlotte Pipe and Foundry recognizes vacuum testing of ABS and PVC DWV piping system to 8.75 inches of mercury is a safe practice and does not object to conducting this type of test. However, vacuum testing is complex and requires dedicated equipment. Identifying leak sites can be difficult. The plumbing industry has not developed an efficient methodology for vacuum testing piping systems in the field.

## The Smoke Test



### WARNING

To reduce the risk of fire, smoke inhalation, chemical inhalation or burns, never use chemical mixtures for producing smoke. These mixtures may be dangerous and can cause serious personal injury.

Should a smoke test be specified by an engineer, architect, or plumbing code, proceed as follows:

1. Permanently connect all fixtures and fill all traps with water.
2. Be prepared to test all parts of the plumbing drainage and ventilation system.
3. Close all windows in the building until the test has been completed.
4. Fill the system with a thick, penetrating smoke that has been generated by one or more smoke-producing machines.
5. When smoke begins to appear at the stack opening on the roof, close off that opening.
6. Continue filling the system with smoke until a pressure equal to one inch of water is built up.
7. Maintain this pressure for fifteen minutes or longer, as required to test the entire system.
8. Check all components of the system to help ensure that smoke is not escaping. Smoke should not be visible at any point, connection, or fixture.

## The Peppermint Test

This test is most often used in older installations to detect faulty plumbing. **NOTE:** Peppermint oils are not chemically compatible with ABS and therefore should not be used to test ABS DWV systems. The peppermint test should only be used to test PVC DWV systems.

1. Permanently connect all fixtures and fill all traps with water.
2. Be prepared to test all parts of the plumbing drainage and ventilation system.
3. Close all windows in the building until the test has been completed.
4. Mix two ounces of peppermint oil with one gallon of hot water.
5. Pour the mixture into the system's roof opening.
6. Tightly close the roof opening.

7. Have a person other than the one that poured the mixture into the system inspect the system for any odor of peppermint.
8. Inspect all system points, connections, and fixtures. There should be no odor of peppermint within the building.

## Testing Pressure System

1. Prior to testing, safety precautions should be instituted to protect personnel and property in case of test failure.
2. Conduct pressure testing with water.
3. The piping system should be adequately anchored to limit movement. Water under pressure exerts thrust forces in piping systems. Thrust blocking should be provided at changes of direction, change in size and at dead ends.
4. The piping system should be slowly filled with water, taking care to prevent surge and air entrapment. The flow velocity should not exceed 5-feet per second for PVC and 8-feet per second for CPVC CTS (see Friction Loss and Flow Velocity charts in this manual).

### NOTICE

**Do not exceed the maximum working pressure of any system components including pipe, fittings, valves, molded or cut threads, unions, mechanical coupling or flanges.**

- The pressure rating of all components must be reduced at temperatures above 73 degrees F. Refer to de-rating table in this manual.
- Exceeding the maximum working temperature or pressure of the system may result in system failure and property damage.



### WARNING

#### Entrapped Air

- **Pressure surges associated with entrapped air may result in serious personal injury, system failure, and property damage.**
- Install air relief valves at the high points in a system to vent air that accumulates during service.
- Failure to bleed trapped air may give faulty test results and may result in an explosion.

The installation tips, warnings and technical information in this Additional Considerations section are intended to help improve material selection and installation techniques. The information found in this section enhances but does not replace the information found in other sections of this Technical Manual.

- Antifreeze Solutions for Pressure PVC and CPVC Systems
- Antifreeze Solutions for ABS DWV Systems
- FlowGuard Gold® Domestic Water Systems
- Disinfection
- The Advantages of a FlowGuard Gold® CPVC System
- Chemical Compatibility with CPVC Products
- Low Temperature and Cold Weather Conditions

## Antifreeze Solutions for Pressure PVC and CPVC Systems

Glycerin antifreeze solutions are recommended for use with FlowGuard Gold® and Corzan® water distribution systems and for PVC pressure and DWV applications.

Glycerin antifreeze should be diluted to the appropriate concentration that provides adequate protection for the intended application. Maximum freeze protection for glycerin-water solutions is -51.7°F (-46.5°C) and occurs when the weight percent of glycerin is 66.7%. The effectiveness of a glycerin/water antifreeze solution diminishes above this concentration. Freeze points of glycerin-water solutions follow:

Propylene glycol or ethylene glycol antifreeze solutions are suitable for use in pressure testing PVC and CPVC pressure and DWV piping systems as follows:

### Freezing Points of Glycerin-Water Solutions (weight %)

Glycerin by weight (%)	Freeze Point °F (°C)
0	32.0 (0.0)
10	29.1 (-1.6)
20	23.4 (-4.8)
30	14.9 (-9.5)
40	4.3 (-15.4)
50	-9.4 (-23.0)
60	-30.5 (-34.7)
66.7	-51.7 (-46.5)
Greater than 66.7	Not Recommended

Propylene glycol or ethylene glycol antifreeze solutions are suitable for use in pressure testing PVC and CPVC pressure and DWV piping systems as follows:

## CAUTION

- Solutions greater than 50% propylene glycol are incompatible with PVC and may cause damage to PVC piping systems.
- Solutions greater than 25% propylene or 50% ethylene are incompatible with CPVC and may cause damage to CPVC piping systems.
- Ethylene glycol is compatible with PVC piping systems up to 100% concentrations.
- 25% Propylene glycol solutions are approved for use with potable water systems and provide freeze protection to about 15°F (-10°C), 50% solutions provide freeze protection to -30°F (-34°C).
- Please see the Chemical Resistance chart contained in this manual for complete chemical resistance data.
- Ethylene glycol solutions are toxic and must therefore be avoided in potable water and food processing systems. 25% ethylene glycol solutions provide freeze protection to about 8°F (-13°C) and 50% solutions provide freeze protection to about -33°F (-36°C).

## Antifreeze Solutions for ABS DWV Systems

Only the following antifreeze may be used with or in conjunction with ABS and ABS Plus® DWV foam core systems:

- 60% glycerol, by weight, in water. Use undiluted.
- 22% magnesium chloride, by weight, in water. Use undiluted.
- "Plastic Pipe Antifreeze" (especially made for plastic pipe).

Do not use any other type antifreeze except those recommended above.

## FlowGuard Gold® Domestic Water Systems

FlowGuard Gold CPVC pipe and fittings are designed, manufactured and listed for domestic water applications. Piping systems using CPVC should be installed by licensed plumbing contractors in accordance with normal industry standards, good plumbing practices and in compliance with applicable plumbing codes, building codes and other regulations.

**NOTICE:** CPVC Schedule 80 domestic water systems must be installed using IPS P-70 or Oatey Industrial Grade primers and IPS 714 or Oatey CPVC Heavy Duty Orange solvent cements. FlowGuard Gold, the industry-leading hot and cold water system, is typically installed in ½ -2 inch applications.



## Low Temperature and Cold Weather Conditions

### Low Temperature Recommendation

Like most materials, PVC and CPVC become more brittle at low temperatures, particularly at temperatures below freezing (32°F). Charlotte Pipe and Foundry recommends taking proper precautions when installing systems at low temperatures including providing proper insulation. If a system is designed to operate at temperatures below freezing (32°F), Charlotte Pipe recommends the following:

1. Reduce water hammer pressure surges to a minimum by:
  - a. Using only slow-acting solenoid valves, if any.
  - b. Reducing pump start-up pressure surges with slow start-up motors and rubber expansion devices.
  - c. Not exceeding maximum fluid velocity of 5-feet per second for PVC and 8-feet per second for CPVC CTS.
2. Provide more than minimum Charlotte Pipe recommended support spacing.
3. Thrust blocking at branches, changes in direction and end of runs.
4. Use expansion/contraction devices when temperature changes occur in runs.
5. Strictly follow chemical-resistance recommendations.
6. Protect piping from UV, if applicable.

### Cold Weather Considerations for CPVC

The following precautions are recommended in cold-weather situations.

#### 1. Freeze Issues

CPVC is a ductile material, which expands and contracts more than metallic plumbing pipe. However, CPVC, like all other piping materials, needs to be protected from freezing. All model plumbing codes require that piping exposed to freezing temperatures be properly insulated.

#### 2. Frozen CPVC Water Lines

Drain the system if overnight temperatures are likely to drop below 32°F. CPVC may split like other materials when water freezes in it.

Immediately take action to eliminate the source of cold air causing the freezing condition, then thaw the water line if possible. If the frozen section of pipe is accessible, heated air can be blown directly onto the frozen area by using a low wattage heater/blower. Also, electrical heat tapes can be applied to the frozen area. **NOTICE:** To avoid damaging the pipe when thawing a frozen CPVC water line, the heat source should not exceed 180°F.

#### 3. Handling

Refrain from unnecessary abuse. Do not drop pipe from trucks, drag pipe on the ground, step on pipe or drop pipe on the ends.

Inspect pipe ends for hairline cracks before making a joint. If any indication of damage or cracking is evident at the tube end, cut off at least 2 inches beyond any visible crack. Do not use dull or broken cutting tools. A wheel-type pipe cutter is recommended.

Store pipe in a heated area whenever possible.

## NOTICE

In understanding spray polyurethane foams, there are two general areas of concern for CPVC pipe and fittings; (1) chemical compatibility and (2) potential damage to pipe and fittings due to high temperatures generated as a result of the exothermic chemical reaction during the installation and curing process. It is possible to apply polyurethane foam insulation properly without damage to CPVC pipe and fittings. However, the use of polyurethane foam insulation in conjunction with CPVC has resulted in the failure of CPVC pipe and fittings and property damage. Therefore, Charlotte Pipe and Foundry does not recommend the use of polyurethane spray on foam insulation in conjunction with its CPVC pipe and fittings.

## Disinfection

FlowGuard Gold CPVC has been tested and found to be unaffected by chlorine in concentrations up to 3,000 parts per million in water. Normal system disinfection at 50 parts per million chlorine will not harm CPVC.

## The Advantages of a FlowGuard Gold® CPVC System

A FlowGuard Gold water distribution system outperforms a metal plumbing system in several important ways:

- It's more energy efficient – with better heat retention and lower hot water heating costs.
- Condensation is reduced – significantly reducing the risk of drip damage.
- It operates quietly – with silent water flow and no banging from water hammer.
- CPVC is resistant to corrosion, pitting and scaling – this means no loss of water pressure and reduced maintenance.

### NOTICE

All pipe thread sealants must conform to the requirements of IAPMO's PS 36 and with the thread sealant manufacturer to confirm that these sealants are chemically compatible with ABS, CPVC, and PVC. Incompatible pipe thread sealants may result in the degradation of plastic pipe or fittings resulting in product failure and property damage.

- Verify that paints, thread sealants, lubricants, plasticized PVC products, foam insulations, caulks, leak detectors, insecticides, termiticides, antifreeze solutions, pipe sleeve, firestop materials or other materials are chemically compatible with ABS, CPVC, or PVC.
- Do not use edible oils such as Crisco® for lubricant.
- Read and follow chemical manufacturer's literature before using with piping materials.
- Confirm compatibility of pipe marking adhesive tape with the manufacturer of the tape to ensure chemical compatibility with CPVC pipe and fittings.

## Chemical Compatibility With CPVC Products

CPVC domestic water systems have been used successfully for 50 years in new construction, repipe and repair. CPVC products are ideally suited for domestic water applications due to their corrosion resistance. Occasionally, however, CPVC can be damaged by contact with chemicals found in some construction products including thread sealant, fire stopping compounds, pipe sleeves or insulation.

Reasonable care needs to be taken to ensure that products coming into contact with CPVC systems are chemically compatible. Charlotte Pipe recommends that CPVC chemical compatibility be confirmed with the manufacturer of any product coming into contact with CPVC piping systems. If chemical compatibility with CPVC is in question, Charlotte Pipe recommends isolating the suspect product from contact with CPVC pipe or fittings. Please call Charlotte Pipe at 800/438-6091 or visit our web site [www.CharlottePipe.com](http://www.CharlottePipe.com) for the latest CPVC Chemical Compatibility sheet.

Care should be taken to isolate CPVC piping systems from direct contact with heavy concentrations of termiticides. Vinyl piping materials such as CPVC may be damaged by termiticides where they are injected into the annular space between the pipe wall and sleeving material trapping the termiticides against the pipe wall. Common-sense precautions will prevent installation problems.

**NOTICE:** In understanding spray polyurethane foams, there are two general areas of concern for ABS, CPVC, and PVC pipe and fittings; (1) chemical compatibility and (2) potential damage to pipe and fittings due to high temperatures generated as a result of the exothermic chemical reaction during the installation and curing process. It is possible to apply polyurethane foam insulation properly without damage to ABS, CPVC, and PVC pipe and fittings. However, the use of polyurethane foam insulation in conjunction with ABS, CPVC, and PVC has resulted in the failure of CPVC pipe and fittings and property damage. Therefore, Charlotte Pipe and Foundry does not recommend the use of polyurethane spray on foam insulation in conjunction with its ABS, CPVC, and PVC pipe and fittings.

### NOTICE

Use of FlowGuard Gold® CTS CPVC all-plastic threaded male adapters in hot water applications may result in system failure and property damage.

- Use plastic threaded CTS CPVC male adapters in cold water applications only.
- Use CTS CPVC x brass threaded transition fittings for hot water applications.
- Do not use compression fittings with brass ferrules to connect to CTS CPVC pipe or fittings where water temperatures will exceed 140 degrees F.
- CPVC pipe can be used with standard brass ferrules to make compression connections where the operating temperature will not exceed 140°F. Apply Teflon (PTFE) tape over the ferrule to allow for the dissimilar thermal expansion and contraction characteristics of the metal ferrule and the plastic pipe.



## Closed-Loop Systems

A closed-loop plumbing system is one in which water from the premises side of the water meter is unable to backflow into the main. This circumstance is becoming more and more prevalent as the result of the growing use of devices such as backflow preventers and pressure-reducing valves.

Allowance must be made for “thermal expansion of the water.” Backflow-prevention devices with built-in bypass capabilities, auxiliary pressure-relief valves or bladder-type expansion tanks are several options available to help resolve the problem and to insure long-term system performance.

Do not rely on an expansion tank to handle thermal expansion of the piping system. Expansion tanks accommodate expansion of the fluid, not longitudinal expansion of the pipe. The piping system must be designed to allow for thermal expansion.

### NOTICE

All pipe thread sealants must conform to the requirements of IAPMO's PS 36 and with the thread sealant manufacturer to confirm that these sealants are chemically compatible with ABS, CPVC, and PVC. Incompatible pipe thread sealants may result in the degradation of plastic pipe or fittings resulting in product failure and property damage.

- Verify that paints, thread sealants, lubricants, plasticized PVC products, foam insulations, caulks, leak detectors, insecticides, termiticides, antifreeze solutions, pipe sleeve, firestop materials or other materials are chemically compatible with ABS, CPVC, or PVC.
- Do not use edible oils such as Crisco® for lubricant.
- Read and follow chemical manufacturer's literature before using with piping materials.
- Confirm compatibility of pipe marking adhesive tape with the manufacturer of the tape to ensure chemical compatibility with CPVC pipe and fittings.

## Connecting CTS CPVC to Fixtures or Other Materials

### Stub-outs for Plumbing Fixtures

CTS CPVC pipe can be used for stub-outs for lavatories, closets and sinks.

### Brass Compression Ferrules

CTS CPVC pipe can be used with standard brass ferrules to make compression connections where the operating temperature will not exceed 140°F. The O.D. of copper tube size (CTS) CPVC pipe is identical to that of copper. We recommend that Teflon (PTFE) tape be applied over the ferrule to allow for the dissimilar thermal expansion and contraction characteristics of the metal ferrule and the plastic pipe that could possibly result in a drip leak over a period of time. **NOTICE:** Do not over-torque the compression connection as over-torquing may result in a cracked pipe. Non-metallic or nylon ferrules are not recommended.

## FlowGuard Gold® and Corzan® Domestic Water Systems Do's and Don'ts

While not a complete list, the following is intended to highlight many of the Do's and Don'ts when installing a FlowGuard Gold and Corzan domestic water system.

### Do's

- Do install CPVC Schedule 80 domestic water systems using IPS P-70 or Oatey Industrial Grade primers.
- Do install CPVC Schedule 80 domestic water systems using IPS 714 or Oatey CPVC Heavy Duty Orange solvent cements.
- Installation should be in accordance with normal industry standards, good plumbing practices, applicable plumbing codes, building codes and other regulations.
- Follow recommended safe work practices.
- Follow proper material handling procedures.
- Keep pipe and fittings in original packaging until needed.
- Cover pipe and fittings with opaque tarp when stored outdoors.
- Make certain that thread sealants, gasket lubricants and firestop materials are compatible with CPVC pipe and fittings.
- Use only latex paint if painting is desired.
- Use tools designed for plastic pipe and fittings.
- Cut pipe square.
- Deburr and bevel pipe before solvent cementing.
- Apply primer and cement with an applicator that is one half the size of the pipe's diameter.
- Rotate pipe ¼ to ½ turn as the pipe is being inserted into the fitting socket.
- Avoid puddling of solvent cement in fitting or pipe.
- Follow recommended cure time for the required pipe diameter and temperature.
- Align all piping system components properly without strain. Do not bend or pull pipe into position after being solvent welded.
- Fill lines slowly and bleed all trapped air from the system prior to conducting a hydrostatic test.
- Visually inspect all joints for proper cementing.

- Allow for movement due to thermal expansion and contraction.
- Use pipe straps that fully encircle the tube.
- Drill holes  $\frac{1}{4}$  inch larger than the outside diameter of the pipe or tube when penetrating wood studs.
- Use protective pipe isolators that allow movement when penetrating steel studs.
- Use metallic or tear drop hangers when suspending tube from all thread rod.
- Confirm compatibility of pipe marking adhesive tape with the manufacturer of the tape to ensure chemical compatibility with CPVC pipe and fittings.
- If pipe sleeve is used, verify that it is chemically compatible with CPVC.
- If pipe sleeve is used, extend it 12 inches above and below the slab.
- Backfill and cover underground piping prior to spraying termiticides in preparation for concrete pour.
- Design the system not to exceed the maximum working pressure of all system components including pipe, fittings, valves, unions and flanges. De-rate the pressure rating of all components if the working temperature will exceed 73 degrees Fahrenheit.
- Do not use solvent cement near sources of heat, open flame, or when smoking.
- Do not hydrostatically test until recommended cure times are met.
- Do not use dull or broken cutting tool blades when cutting pipe. At low temperatures a wheel type pipe cutter designed for plastic pipe is recommended.
- Do not use petroleum or solvent based paints, sealants, lubricants, or firestop materials.
- Do not use edible oils such as Crisco for lubricant.
- Do not restrict expansion or contraction.
- Do not install in cold weather without allowing for thermal expansion.
- Do not use tube straps that tend to over tighten or restrain the system.
- Do not use wood or plastic wedges that restrain the system.
- Do not bend CPVC tube transmitting mechanical stress to a fitting. Do not install fittings under stress.
- Do not terminate a pipe run against an immovable object (e.g. wall or floor joist).
- Do not allow heavy concentrations of termiticides to come into direct and sustained contact with CPVC pipe.
- Do not inject termiticides into the annular space between pipe wall and sleeving material.
- Do not spray termiticides, when preparing the slab, without first backfilling over underground piping.
- Do not exceed a maximum fluid flow velocity of 8-feet per second for CPVC CTS and 5-feet per second for CPVC Schedule 80.
- Do not exceed the maximum pressure rating of pipe, fittings, valves or flanges.
- Do not use an external heat source to bend CPVC.
- Do not exceed the max operating temperature or pressure of any system components.
- Do not connect CTS CPVC or Schedule 80 CPVC directly to a boiler.

## NOTICE

In understanding spray polyurethane foams, there are two general areas of concern for CPVC pipe and fittings; (1) chemical compatibility and (2) potential damage to pipe and fittings due to high temperatures generated as a result of the exothermic chemical reaction during the installation and curing process. It is possible to apply polyurethane foam insulation properly without damage to CPVC pipe and fittings. However, the use of polyurethane foam insulation in conjunction with CPVC has resulted in the failure of CPVC pipe and fittings and property damage. Therefore, Charlotte Pipe and Foundry does not recommend the use of polyurethane spray on foam insulation in conjunction with its CPVC pipe and fittings.

## Don'ts

- Do not test with air or any compressed gas. Compressed air or gas testing may result in injury or death.
- Do not use to convey compressed air or any compressed gas. Conveying compressed air or gas may result in injury or death.
- Do not use solvent cement that exceeds its shelf life or has become discolored or gelled.

## NOTICE

**Use of FlowGuard Gold® CTS CPVC all-plastic threaded male adapters in hot water applications may result in system failure and property damage.**

- Use plastic threaded CTS CPVC male adapters in cold water applications only.
- Use CTS CPVC x brass threaded transition fittings for hot water applications.
- Do not use compression fittings with brass ferrules to connect to CTS CPVC pipe or fittings where water temperatures will exceed 140 degrees F.
- CPVC pipe can be used with standard brass ferrules to make compression connections where the operating temperature will not exceed 140°F. Apply Teflon (PTFE) tape over the ferrule to allow for the dissimilar thermal expansion and contraction characteristics of the metal ferrule and the plastic pipe.

### Tub Fillers, Showerheads and Outside Sillcocks

CTS CPVC should be connected to tub fillers, showerheads and outside sillcocks with a CPVC to brass threaded transition fitting or a metal nipple. Direct connection to CPVC or CPVC threaded fittings is not recommended.

### Water Heaters / Boilers

Instructions from the manufacturer of the water heater and applicable local plumbing and building codes should be followed.

Do not use FlowGuard Gold CTS CPVC pipe or fittings on systems capable of achieving temperatures greater than 180°F.

When FlowGuard Gold CTS CPVC pipe is used with an electric water heater, a CPVC-to-brass transition fitting should be used. CPVC threaded male adapters should not be used to connect to water heaters or connect to metallic nipples in close proximity to water heater.

When connecting to a gas water heater, at least 6 inches of metal nipple or appliance connector should be used so that the CPVC tubing cannot be damaged by the build-up of excessive radiant heat from the draft diverter. Some high-efficiency direct-vent gas water heaters eliminate the radiant heat from the flue and can be piped directly to the water heater. A brass threaded CPVC transition fitting must be used for connection to the water heater.

**NOTICE:** Do not connect CTS CPVC or Schedule 80 CPVC directly to a boiler due to excessive heat generated. The maximum recommended temperature and de-rating of working

pressure applies to both heat generated from fluid being distributed through pipe system and heat generated from sources external to the pipe system.

Charlotte Pipe recommends the use of a CPVC-to-brass threaded transition fitting to connect to a tankless gas water heater. Verify code requirements prior to installation.

## T/P Relief Valve Drainage Pipe (Elevated-Temperature Performance)

CTS CPVC pipe conforming to ASTM D 2846 is rated for continuous operation at 180°F/100 psi. The following addresses the expected capabilities of CPVC during short-term exposure to temperatures and/or pressures above 180°F/100 psi that may occur from time to time. However, CTS CPVC pipe is not recommended for pressure applications where temperatures will consistently exceed 180°F.

### 1. Use of CTS CPVC for T/P relief valve drainage lines

CPVC is a suitable material for T/P discharge piping. A CPVC-to-brass transition fitting should be used when connecting to a T/P relief valve.

CPVC pipe is approved for T/P discharge piping under the following model codes:

Uniform Plumbing Code (UPC) 608.5 Discharge Piping, which states, "Materials shall be rated at not less than the operating temperature of the system and approved for such use."

International Plumbing Code (IPC) 504.6 Requirements for Discharge Piping, which states, "Be constructed of those materials listed in Section 605.4."

### 2. Short-term elevated pressure performance

CPVC meets the quality control provisions of ASTM D 2846 Standard (Table 5) which requires that CPVC-CTS systems (pipe, fittings, and cemented joints) have the capability of withstanding short-term pressure tests at 180°F of at least 521 psi for 6 minutes and 364 psi for 4 hours.

## HVAC Condensate Drain Lines

### **NOTICE**

Prior to installation, check with the manufacturer of the HVAC equipment to confirm the compatibility of residual oils and refrigerants with ABS, CPVC, or PVC.

Prior to installing CPVC or PVC piping in hydronic applications, it is important to flush the interior of the heat exchangers and the exterior of the evaporator coils thoroughly with a mild ionic detergent solution to remove incompatible oils. Failing to do so could result in system failure and property damage.

Verify that all boiler cleaning and sealing chemicals used in hydronic radiant heating systems are compatible with CPVC or PVC. Failure to do so could result in system failure and property damage.

Equipment leaks in refrigeration or HVAC systems may release POE oils or other contaminants into the piping system. These oils and contaminants are incompatible with CPVC or PVC and such exposure may result in pipe or fitting failure regardless of flushing.

Prior to installation, check with the manufacturer of the HVAC equipment to confirm the compatibility of residual oils and refrigerants with CPVC, ABS, or PVC.

Exercise caution when using FlowGuard Gold® CPVC pipe or fittings for HVAC- or refrigerant-condensate lines. Some refrigerant systems contain oils that may damage CPVC products. In

HVAC applications, some heat exchangers or condenser coils may contain residual oils from the manufacturing process which can cause cracking of CPVC. Caution should be exercised when installing CPVC in combination hot/air handling units or as condensate-drain lines from air conditioning systems. Confirm the compatibility of CPVC with residual oils prior to installation. The interior of heat exchangers or the exterior of condenser coils may be thoroughly cleaned with a detergent solution to remove incompatible oils prior to piping installation. A rinse with clean water to completely clean the system is advisable as a final flushing. Some refrigerant systems contain oils, commonly referred to as poly olester (POE) oils that may damage CPVC, ABS, and PVC and such exposure may result in pipe or fitting failure regardless of cleaning or flushing the system. Charlotte Pipe and Foundry will not accept responsibility for failure resulting from exposure to compressor oils in HVAC-or refrigerant-condensate lines.

## Thermal Expansion

Expansion Tanks do not compensate for linear expansion and contraction of the pipe and fittings. Expansion tanks are designed to compensate for the expansion of the liquids within the system.

For information on thermal expansion please see Expansion and Contraction in the Design and Engineering information section of this manual.

## R-Values and Thermal Conductivity

### Thermal Conductivity

R-Value is a measure of the thermal resistance of a material. Thermal resistance is an index of a material's resistance to the flow of heat. K-Value is a measure of a material's thermal conductivity measured in BTU's and is the reciprocal of the R-Value. The thermal resistances for PVC and CPVC remain constant as C-Values. They are as follows:

PVC Thermal Conductivity  $C = 1.2 \text{ BTU in/Hr Sq Ft } ^\circ\text{F}$

CPVC Thermal Conductivity  $C = .96 \text{ BTU in/Hr Sq Ft } ^\circ\text{F}$

R-Value can be viewed as an equation when calculating for various thickness of pipe.

$R = \text{Pipe Wall Thickness divided by } C$

The table below represents the R-Values for PVC Schedule 40 & 80 and CPVC CTS FlowGuard Gold.

**Note:** Always follow local code requirements for insulation installation. Some code jurisdictions require insulation to be installed in accordance with the International Energy Conservation Code.

### Condensation and Sweating

Due to its low coefficient of thermal conductivity, it is often not necessary to insulate FlowGuard Gold CPVC against condensation within conditioned buildings. Two conditions that control sweating of a pipe are (1) the pipe surface temperature, which depends on the temperature of the water inside the pipe and (2) the relative humidity of the air around the pipe. Because each of the factors can vary greatly, it is possible that conditions exist that can cause CPVC pipe to sweat. Under most conditions that cause copper pipe to sweat and drip, FlowGuard Gold pipe will remain free of condensation.

Nominal Pipe Size	Schedule 40 Wall Thickness	PVC Schedule 40 R-Value	Schedule 80 Wall Thickness	PVC Schedule 80 R-Value	SDR 11 CTS Wall Thickness	CPVC SDR 11 R-Value
1/4"			0.119	0.099		
3/8"			0.126	0.105		
1/2"	0.109	0.091	0.147	0.123	0.068	0.071
3/4"	0.113	0.094	0.154	0.128	0.080	0.083
1"	0.133	0.111	0.179	0.149	0.102	0.106
1 1/4"	0.140	0.117	0.191	0.159	0.125	0.130
1 1/2"	0.145	0.121	0.200	0.167	0.148	0.154
2"	0.154	0.128	0.218	0.182	0.193	0.201
2 1/2"	0.203	0.169	0.276	0.230		
3"	0.216	0.180	0.300	0.250		
4"	0.237	0.198	0.337	0.281		
5"	0.258	0.215	0.375	0.313		
6"	0.280	0.233	0.432	0.360		
8"	0.322	0.268	0.500	0.417		
10"	0.365	0.304	0.593	0.494		
12"	0.406	0.338	0.687	0.573		
14"	0.437	0.364	0.750	0.625		
16"	0.500	0.417	0.843	0.703		

## Hydronic Heating, Chilled Water, or Geothermal Applications

### NOTICE

Prior to installation, check with the manufacturer of the HVAC equipment to confirm the compatibility of residual oils and refrigerants with ABS, CPVC, or PVC.

Prior to installing CPVC or PVC piping in hydronic applications, it is important to flush the interior of the heat exchangers and the exterior of the evaporator coils thoroughly with a mild ionic detergent solution to remove incompatible oils. Failing to do so could result in system failure and property damage.

Verify that all boiler cleaning and sealing chemicals used in hydronic radiant heating systems are compatible with CPVC or PVC. Failure to do so could result in system failure and property damage.

Equipment leaks in refrigeration or HVAC systems may release POE oils or other contaminants into the piping system. These oils and contaminants are incompatible with CPVC or PVC and such exposure may result in pipe or fitting failure regardless of flushing.

When plastic piping is used for recirculating systems such as hydronic, chilled water or geothermal heat pump systems, careful consideration of piping material characteristics and system requirements must be made. This includes taking into account pressure, temperature, flow velocity, design stresses, environmental factors and the chemical resistance of the piping materials to the fluids (heat-transfer fluids, anti-freeze solutions and other chemicals) in the system. Ultimately the engineer, designer or owner must evaluate these characteristics and system requirements in order to select the correct piping product for the particular application. The table below highlights some of the key points to consider when designing or installing these types of systems.

This manual is not a complete engineering reference addressing all aspects of design and installation of these systems. Many excellent references are available on this topic. The International Ground Source Heat Pump Association: [www.igshpa.okstate.edu](http://www.igshpa.okstate.edu) or The GEO Exchange at [www.geoexchange.org](http://www.geoexchange.org).

CPVC CTS FlowGuard Gold does not typically require an oxygen barrier. In accordance with ASTM D 2846, CPVC CTS is manufactured as a solid-wall piping system and is not manufactured in a cross-linked or co-extruded process like other materials that are prone to oxygen permeation. Unlike CPVC, some cross-linked systems used in applications such as hydronic heating require a layer of aluminum to be present to stop oxygen diffusion through the polymer matrix.

With regard to oxygen permeability of a CPVC system, the following data should be considered:

- 1) The oxygen transmission rate in CPVC at 73°F (23°C) is approximately 7.2 cc/(m<sup>2</sup>/day).
- 2) The oxygen permeation coefficient in CPVC at 73°F (23°C) is approximately 180 cc/mil/(m<sup>2</sup>/day/atm).
- 3) The oxygen diffusion coefficient in CPVC is approximately 6.25e/9 cm<sup>2</sup>/sec.

### “DOs” for all hydronic applications

- Do install CPVC Schedule 80 domestic water systems using IPS P-70 or Oatey Industrial Grade primers.
- Do install CPVC Schedule 80 domestic water systems using IPS 714 or Oatey CPVC Heavy Duty Orange solvent cements.
- Install in accordance with both Charlotte Pipe and Foundry’s and solvent cement manufacturer’s recommendations and installation instructions.
- Follow recommended safe work practices.
- Verify that the maximum outlet temperature and pressure of the boiler is less than the temperature and pressure rating of the pipe (see charts below).
- Always use the proper derating factors with FlowGuard Gold and Corzan CPVC pipe to find the pressure rating at the applicable operating temperature.
- Always follow applicable codes and approvals when installing plumbing and heating equipment.
- Ensure that the system design allows for thermal expansion and contraction as recommended in the Charlotte Pipe and Foundry Plastics Technical Manual.
- Use only CPVC x brass threaded transition fittings when installing FlowGuard Gold systems.
- Use proper solvent cementing practices, including beveling and proper dauber sizing.
- Align all piping system components properly without strain. Do not bend or pull pipe into position after being solvent welded.
- Provide additional support to the brass side of a CPVC x brass transition or other metallic components to support the weight of the metal system.
- Use check valves, heat traps or back flow preventers to prevent cross-connections between hot and cold water lines.
- Flush the interior of heat exchangers or the exterior of condenser coils thoroughly with mild ionic detergent solution to remove incompatible oils prior to piping installation.
- Rinse with clean water to purge the system as a final flushing.
- Verify that all boiler cleaning and sealing chemicals used in the hydronic radiant heating system are compatible with CPVC.



## **“DON'Ts” for all hydronic applications**

- Do not exceed the operating temperature or operating pressure of the piping system.
- Do not use CPVC male or female adapters with plastic molded threads for FlowGuard Gold systems.
- Do not use the CPVC piping system to support any metallic components.
- Do not use compression fittings for hydronic radiant heating applications.
- Do not use solvent cement that exceeds its shelf life, has become discolored or has gelled.
- Do not use CPVC tees or other CPVC components as hot and cold mixing devices.
- Do not apply excessive solvent-cement to the joints. Puddling of solvent cement must be avoided.
- Do not rely on an expansion tank to handle thermal expansion of the piping system. Expansion tanks accommodate expansion of the fluid, not longitudinal expansion of the pipe. The piping system must be designed to allow for thermal expansion.

## **NOTICE**

**Do not exceed the maximum working pressure of any system components including pipe, fittings, valves, molded or cut threads, unions, mechanical coupling or flanges.**

- The pressure rating of all components must be reduced at temperatures above 73 degrees F. Refer to de-rating table in this manual.
- Exceeding the maximum working temperature or pressure of the system may result in system failure and property damage.

## **NOTICE**

**Failure to compensate for expansion and contraction caused by temperature change may result in system failure and property damage.**

- Do not restrict expansion or contraction. Restraining movement in piping systems is not recommended and may result in joint or fitting failure.
- Use straps or clamps that allow for piping system movement.
- Align all piping system components properly without strain. Do not bend or pull pipe into position after being solvent welded.
- Do not terminate a pipe run against a stationary object (example: wall or floor joist).
- Do not install fittings under stress.

## **NOTICE**

Prior to installation, check with the manufacturer of the HVAC equipment to confirm the compatibility of residual oils and refrigerants with ABS, CPVC, or PVC.

Prior to installing CPVC or PVC piping in hydronic applications, it is important to flush the interior of the heat exchangers and the exterior of the evaporator coils thoroughly with a mild ionic detergent solution to remove incompatible oils. Failing to do so could result in system failure and property damage.

Verify that all boiler cleaning and sealing chemicals used in hydronic radiant heating systems are compatible with CPVC or PVC. Failure to do so could result in system failure and property damage.

Equipment leaks in refrigeration or HVAC systems may release POE oils or other contaminants into the piping system. These oils and contaminants are incompatible with CPVC or PVC and such exposure may result in pipe or fitting failure regardless of flushing.

## **NOTICE**

**Use of FlowGuard Gold® CTS CPVC all-plastic threaded male adapters in hot water applications may result in system failure and property damage.**

- Use plastic threaded CTS CPVC male adapters in cold water applications only.
- Use CTS CPVC x brass threaded transition fittings for hot water applications.
- Do not use compression fittings with brass ferrules to connect to CTS CPVC pipe or fittings where water temperatures will exceed 140 degrees F.
- CPVC pipe can be used with standard brass ferrules to make compression connections where the operating temperature will not exceed 140°F. Apply Teflon (PTFE) tape over the ferrule to allow for the dissimilar thermal expansion and contraction characteristics of the metal ferrule and the plastic pipe.



## Material Selection, Special System Design and Engineering Considerations

### Selection of Materials For Sanitary and Storm Drainage

Engineers and designers today have a number of materials from which to choose as they design sanitary and storm drainage systems for residential and commercial projects. Due to its exceptional strength and combination of being non-combustible and extremely quiet, cast iron soil pipe is a very popular choice for commercial construction. Upscale homes often feature cast iron stacks combined with plastic used for lavs, showers and tubs for a system Charlotte Pipe calls a "Quiet House®" design. PVC and ABS DWV systems are allowed under all of the major national plumbing codes unless restricted by local or state amendment and are very popular as well.

Charlotte Pipe manufactures ABS cellular (foam) core pipe conforming to ASTM F 628 and ASTM F 1488 as well as PVC pipe in both solid wall and cellular core types. PVC solid wall meets the requirements of ASTM D 1785 and D 2665, and PVC cellular core pipe conforms to ASTM F 891. All of these plastic pipe systems are allowed for sanitary and storm drainage both above and below grade in the Uniform Plumbing Code (UPC), the International Plumbing Code (IPC), the National Standard Plumbing Code (NSPC) and most local or state variations thereof. None of these national model codes differentiate between residential or commercial uses of these plastic systems or otherwise restrict the use of any of these systems to any specific class of construction. All of the systems can be installed below grade, under slab and above grade in most areas except those classified as "return air plenums."

Solid wall pipe is just as the name implies: solid PVC material throughout the entire pipe wall. Cellular core pipe is manufactured using a unique co-extrusion process that produces pipe with a thin solid inner layer and outer layer with a foam core between these walls. Foam core pipe has the exact same dimensions as solid wall, yet is lighter and less expensive. Noise transmission is a function of density so while cast iron is by far the quietest material, PVC solid wall would be somewhat less noisy than either PVC or ABS cellular core pipe. While both are suitable for burial at most depths and common soil types, solid wall pipe is somewhat more "robust" and has a higher pipe stiffness, particularly in sizes 6" and smaller. Both ASTM F 628 and F 891 have the following limitation; Appendix X3, Installation, paragraph X3.1: maximum aggregate size shall be limited to 1/2 in. (13 mm) for angular and 3/4 in. (19 mm) for rounded particles. This statement is significant as ASTM D 2321

allows aggregate and stone that pass through 1½" sieve. PVC is classified as a flexible piping system, and as such it is dependant upon proper bedding and backfill for its ability to withstand Earth and live loads. Therefore, all plastic pipe must be installed below grade in accordance with ASTM D 2321. Cellular core pipe of any type is designed for drainage only, carries no pressure rating and Charlotte Pipe marks each piece with the print line "Not for Pressure." PVC solid wall pipe is "dual marked" and meets the ASTM standards for both pressure and drainage pipe.

Many designers allow the use of cellular core pipe on residential or light commercial projects and require the use of solid wall PVC or cast iron on commercial projects such as institutions, schools, restaurants, hospitals etc. Charlotte Pipe recommends that cellular core PVC pipe be installed in commercial applications with caution. Underground installations should be in strict conformance to ASTM D 2321. Ultimately the engineer, designer, developer or owner must evaluate the requirements of each project and specify the products they feel best suit their design criteria.

### Using Plastics in Multi-Story Construction

Incorporating plastic piping systems into multi-story construction raises special considerations. Charlotte Pipe plastic pipe and fittings are warranted to conform to ASTM or other applicable product-based standard, not for any particular system design.

Products and materials selected for use in multi-story construction (four floors and up) must conform to all applicable building, plumbing and fire codes. Product selection and/or specification should be made by an architect, engineer, contractor, or other licensed professional. This must include specification of a code-compliant, chemically compatible firestop system with an appropriate service life, which must be properly installed and inspected for conformance to building, plumbing and fire codes by the responsible governmental authority.

In selecting products and material for multi-story construction, consideration should be given to Charlotte Pipe's cast iron soil pipe products, which are an excellent choice for many multi-story applications. Charlotte Pipe recommends noncombustible cast iron DWV piping systems in multi-story construction.

## Engineered Applications

Over the past few years many new innovations have been introduced to the industry including siphonic roof drainage, solvent, air admittance devices and other products. Some of these products do not conform to existing standards or to the requirements of the model plumbing codes in some instances, reducing the pipe inside diameter and reducing flow. Rather, they are designed into the system by engineers and approved as an alternate material within the code.

Charlotte Pipe and Foundry manufactures pipe and fitting systems that conform to published ASTM and Cast Iron Soil Pipe Institute standards. Products are warranted to conform to the requirements of applicable standards when used for the applications defined within these standards. Charlotte Pipe and Foundry will not accept liability for applications that do not conform to the standards to which we manufacture.

**WARNING**

To reduce the risk of death or serious injury from an explosion, collapse or projectile hazard and to reduce the risk of property damage from a system failure:

- Always follow the warnings and procedures provided in this manual.
- Only use ABS / CPVC / PVC pipe and fitting for the conveyance of fluids as defined within the applicable ASTM standards.
- Never use ABS / CPVC / PVC pipe and fittings for the conveyance of gasses.
- Never use ABS / CPVC / PVC pipe or fittings in structural application or in any load-bearing applications.
- Never strike the pipe or fittings or drive them into the ground or into any other hard substance.

## Using Plastics for Combustion Gas Venting

Charlotte Pipe recommends that inquiries about the suitability of plastic piping systems for venting combustion gases should be directed to the manufacturer of the water or space heating equipment being installed. As stated in the International Code Council's International Fuel Gas Code 503.4.1.1:

*Plastic Pipe and fittings used to vent appliances shall be installed in accordance with the appliance manufacturer's installation instructions.*

The residential water heater certification and safety standard, ANSI Z21.10 1-2014/CSA 4.1-2014, has been modified as it relates to the use of certain plastic venting materials and now prohibits the use of cellular core pipe. Charlotte Pipe prohibits the use of its PVC cellular core pipe, ABS cellular core pipe and ConneCTite fittings for all combustion gas venting applications.

Furthermore, several of the ASTM standards applicable to plastic pipe and fittings that Charlotte Pipe manufactures include the following note: **This standard specification does not include requirements for pipe and fittings intended to be used to vent combustion gases.**

**WARNING**

**Combustion Gas Venting**

Failure to properly vent combustion gas may result in serious injury or death from carbon monoxide.

- Always install / use pipe or fittings as specified by the appliance manufacturer's installation instructions to vent appliances.
- Never use PVC cellular core, ABS cellular core pipe or ConneCTite® fittings for combustion gas venting.

## PVC Schedule 80 Pipe for DWV Applications

Occasionally a designer will specify Schedule 80 PVC pressure pipe meeting ASTM D 1785 for a DWV application in combination with Schedule 40 PVC DWV (Drainage) fittings meeting ASTM D 2665. Typically the application is underground and the designer is interested in specifying a pipe that is more robust than standard Schedule 40 PVC.

Charlotte Pipe does not recommend using Schedule 80 pipe in combination with Schedule 40 DWV fittings due to the dimensional mismatch between these products. Schedule 80 pipe has a significantly smaller inside diameter (ID) than Schedule 40 pipe. When Schedule 80 pipe is installed in a DWV fitting hub, the reduced ID of Schedule 80 pipe forms a restriction or ledge at every fitting hub that will impede flow, possibly leading to buildup and clogs. Additionally, Schedule 80 PVC pipe is not marked or listed in the model plumbing codes for DWV applications. ASTM D 1785 is exclusively a standard for pressure-rated pipe. Additionally, pressure-pattern fittings do not have a sanitary turn which is necessary to allow waste to travel through the fitting unobstructed; therefore, Schedule 80 pressure-pattern fittings would not be an appropriate product for the application. There is no ASTM standard for Schedule 80 DWV fittings and except for some large-diameter fabricated fittings, no Schedule 80 DWV fittings are offered by any U. S. manufacturer.

If Schedule 80 pipe is being specified for a DWV application, it is often motivated by a desire for a more robust product with greater earth / live load carrying capability in underground applications. In these instances Charlotte Pipe recommends Cast Iron Soil Pipe for the application as it is a robust product with the ability to resist tremendous earth and live loads. In contrast, PVC pipe is a flexible conduit which is dependent upon the support provided by the surrounding soil for its ability to withstand external loads.

If the designer determines that PVC is the best material for a commercial DWV application, Charlotte Pipe recommends Schedule 40 DWV pipe and fittings that conform to ASTM D 2665; this will ensure a Schedule 40 solid-wall PVC pipe product that is more robust than cellular or foam-core pipe. Cellular or foam-core Schedule 40 pipe conforms to ASTM F 891, is lighter, has reduced pipe stiffness, reduced resistance to mechanical damage, and most specifiers believe it is less appropriate for commercial applications. PVC pipe should always be installed underground per ASTM D 2321. For pipe being installed in unstable or unusual soil conditions, additional installation procedures may be required. Consult a soil expert and/or structural engineer for guidance. Plastic pipe suspended from an on-grade slab must be installed in accordance with ASTM F 2536.

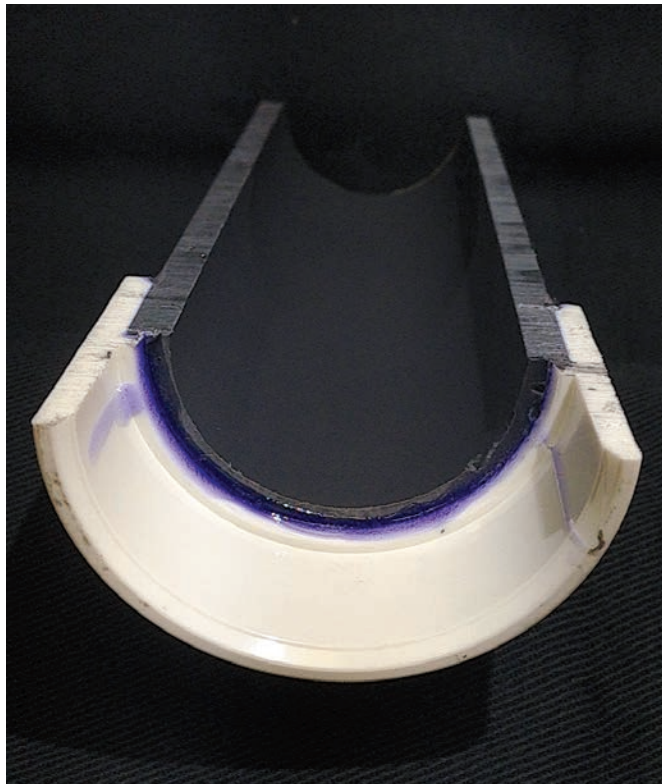

# CHEMICAL RESISTANCE

The following table gives the chemical resistance of ABS, CPVC, and PVC thermoplastic piping materials and three commonly used seal materials. The information shown is based upon laboratory tests conducted by the manufacturers of the materials, and it is intended to provide a general guideline on the resistance of these materials to various chemicals. **NOTICE:** This table is not a guarantee, and any piping systems using products made of these materials should be tested under actual service conditions to determine their suitability for a particular purpose. See website for most current data: [www.charlottepipe.com](http://www.charlottepipe.com)

CAUTION

ABS, CPVC, and PVC piping systems have very different chemical resistance. Review manufacturer's literature for all chemicals coming into contact with the piping materials prior to use.

Number = Maximum Recommended Temp. (°F)\*\*      CF = Consult Factory      NR = Not Recommended      •• = Incomplete Data

Chemical Name	CAS #	Pipe & Fitting Materials Recommended Max. Temp (°F)			Seal Materials Recommended Max. Temp. (°F)		
		ABS	PVC	CPVC	Viton®	EPDM	
1-Octanol .....	111-87-5	NR	••	NR	••	••	••
Acetaldehyde.....	75-07-0	NR	NR	NR	NR	200	NR
Acetamide.....	60-35-5	120	••	••	NR	200	NR
Acetate Solvent, Crude.....	Category	NR	NR	NR	NR	200	NR
Acetate Solvent, Pure.....	Category	NR	NR	NR	NR	200	NR
Acetic Acid, 10% .....	64-19-7	120	140‡	180‡	73	200	NR
Acetic Acid, 20% .....	64-19-7	NR	140‡	180‡	NR	200	NR
Acetic Acid, 50% .....	64-19-7	NR	73‡	NR	NR	140	NR
Acetic Acid, 80% .....	64-19-7	NR	NR	NR	NR	140	NR
Acetic Acid, Glacial.....	64-19-7	NR	NR	NR	NR	73	NR
Acetic Anhydride.....	108-24-7	NR	NR	NR	NR	NR	73
Acetone.....	67-64-1	NR	NR	NR	NR	200	NR
Acetonitrile.....	75-05-8	NR	NR	NR	NR	NR	73
Acetophenone.....	98-86-2	NR	NR	NR	NR	140	NR
Acetyl Chloride.....	75-36-5	NR	NR	NR	185	NR	NR
Acetylene .....	74-86-2	140§	140§	180§	200	200	73
Acrylic Acid.....	79-10-7	NR	NR	NR	NR	NR	NR
Acrylonitrile.....	107-13-1	NR	73	NR	NR	100	NR
Adipic Acid (Sat'd).....	124-04-9	••	140	180	160	140	140
Alcohol, Allyl.....	107-18-6	NR	NR	NR	73	70	73
Alcohol, Amyl.....	71-41-0	NR	NR	NR	160	200	140
Alcohol, Benzyl.....	100-51-6	NR	NR	NR	140	NR	NR
Alcohol, Butyl.....	Category	NR	100	NR	200	140	140
Alcohol, Diacetone.....	123-42-2	NR	NR	NR	NR	70	NR
Alcohol, Ethyl (Ethanol) Up to 5%.....	64-17-5	73	140	180	200	200	160
Alcohol, Ethyl (Ethanol) Over 5%.....	64-17-5	NR	140	180	NR	200	140
Alcohol, Hexyl (Hexanol).....	111-27-3	NR	100	NR	200	NR	NR
Alcohol, Isopropyl (Isopropanol).....	67-63-0	NR	140	NR	160	160	73
Alcohol, Methyl (Methanol).....	67-56-1	NR	140	140	NR	160	160
Alcohol, Octyl (1-n-Octanol).....	111-87-5	NR	100	73	73	NR	NR
Alcohol, Propyl (Propanol).....	71-23-8	NR	140	NR	200	200	140
Allyl Alcohol.....	107-18-6	NR	NR	NR	73	70	73
Allyl Chloride.....	107-05-1	NR	NR	NR	NR	NR	NR
Aluminum Acetate.....	Category	140	••	180	NR	200	NR
Aluminum Ammonium Alum.....	7784-25-0	••	140	180	200	100	100

Acrylonitrile-Butadiene-Styrene Polyvinyl Chloride Type 1 Grade 1 Chlorinated Polyvinyl Chloride Type IV Grade 1  
 Fluorocarbon Elastomer (Viton® is a registered trademark of the DuPont Co.) Ethylene Propylene Diene Monomer  
 \*\* Maximum recommended temperature, for chemical resistance, under normal conditions. § Non-pressure, vent-only, applications when chemical is in gas form.  
 ‡ Must use solvent cement specially formulated for hypochlorite or caustic chemical service (IPS Weld-On 724 or equal).

# CHEMICAL RESISTANCE

The following table gives the chemical resistance of ABS, CPVC, and PVC thermoplastic piping materials and three commonly used seal materials. The information shown is based upon laboratory tests conducted by the manufacturers of the materials, and it is intended to provide a general guideline on the resistance of these materials to various chemicals. **NOTICE:** This table is not a guarantee, and any piping systems using products made of these materials should be tested under actual service conditions to determine their suitability for a particular purpose. See website for most current data: [www.charlottepipe.com](http://www.charlottepipe.com)

**CAUTION**

ABS, CPVC, and PVC piping systems have very different chemical resistance. Review manufacturer's literature for all chemicals coming into contact with the piping materials prior to use.

Number = Maximum Recommended Temp. (°F)\*\*    CF = Consult Factory    NR = Not Recommended    • • = Incomplete Data

Chemical Name	CAS #	Pipe & Fitting Materials Recommended Max. Temp (°F)			Seal Materials Recommended Max. Temp. (°F)		
		ABS	PVC	CPVC	Viton ®	EPDM	Neoprene
Aluminum Chloride.....	7446-70-0	140	140	180	200	200	160
Aluminum Chrome.....	Metal Alloy	• •	140	180	200	200	160
Aluminum Fluoride.....	7784-18-1	NR	73	180	200	200	160
Aluminum Hydroxide.....	21645-51-2	140	140‡	180‡	200	200	100
Aluminum Nitrate.....	13473-90-0	140	140	180	100	200	100
Aluminum Oxychloride.....	13596-11-7	140	140	180	NR	• •	• •
Aluminum Potassium Sulfate.....	10043-67-1	• •	140	180	200	200	160
Aluminum Sulfate.....	10043-01-3	140	140	180	185	100	100
Alums.....	Category	140	140	180	200	100	100
Amines, General.....	Category	NR	NR	NR	NR	NR	NR
Ammonia, Aqueous.....	7664-41-7	NR	140	NR	NR	175	150
Ammonia Aqua 10%.....	7664-41-7	• •	73	NR	NR	140	• •
Ammonia, (25% Aqueous).....	7664-41-7	140	NR	NR	NR	140	• •
Ammonia Hydrate.....	7664-41-7	140	NR	NR	NR	140	• •
Ammonia, Gas.....	7664-41-7	140§	140§	NR	NR	140	140
Ammonia Liquid (Concentrate).....	7664-41-7	NR	NR	NR	NR	140	73
Ammonium Acetate.....	631-61-8	• •	140	180	73	140	140
Ammonium Benzoate.....	1863-63-4	• •	• •	180	• •	• •	• •
Ammonium Bifluoride.....	1341-49-7	• •	140	180	200	200	• •
Ammonium Bisulfide.....	12124-99-1	140	140	180	• •	• •	• •
Ammonium Carbonate.....	506-87-6	140	140	180	200	200	140
Ammonium Chloride.....	12125-02-9	120	140	180	200	200	160
Ammonium Citrate.....	Category	120	• •	180	NR	73	73
Ammonium Dichromate.....	7789-09-5	120	140	• •	NR	73	100
Ammonium Fluoride, 10%.....	12125-01-8	120	140	180	140	200	100
Ammonium Fluoride, 25%.....	12125-01-8	120	73	180	140	200	73
Ammonium Hydroxide, <10%.....	1336-21-6	73	140‡	NR	70	200	160
Ammonium Hydroxide, >10%.....	1336-21-6	73	73‡	NR	NR	200	150
Ammonium Metaphosphate.....	13446-46-3	120	140	180	200	200	• •
Ammonium Nitrate.....	6484-52-2	120	140	180	100	200	160
Ammonium Persulphate.....	7727-54-0	120	140	73	• •	200	73
Ammonium Phosphate.....	10361-65-6	120	140	73	185	200	140
Ammonium Sulfamate.....	7773-06-0	120	• •	180	• •	• •	• •
Ammonium Sulfate.....	7783-20-2	120	140	180	200	200	160
Ammonium Sulfide.....	12135-76-1	120	73	180	200	200	• •

Acrylonitrile-Butadiene-Styrene Polyvinyl Chloride Type 1 Grade 1 Chlorinated Polyvinyl Chloride Type IV Grade 1  
 Fluorocarbon Elastomer (Viton ® is a registered trademark of the DuPont Co.) Ethylene Propylene Diene Monomer  
 \*\* Maximum recommended temperature, for chemical resistance, under normal conditions. § Non-pressure, vent-only, applications when chemical is in gas form.  
 ‡ Must use solvent cement specially formulated for hypochlorite or caustic chemical service (IPS Weld-On 724 or equal).



# CHEMICAL RESISTANCE

The following table gives the chemical resistance of ABS, CPVC, and PVC thermoplastic piping materials and three commonly used seal materials. The information shown is based upon laboratory tests conducted by the manufacturers of the materials, and it is intended to provide a general guideline on the resistance of these materials to various chemicals. **NOTICE:** This table is not a guarantee, and any piping systems using products made of these materials should be tested under actual service conditions to determine their suitability for a particular purpose. See website for most current data: [www.charlottepipe.com](http://www.charlottepipe.com)

**CAUTION**

ABS, CPVC, and PVC piping systems have very different chemical resistance. Review manufacturer's literature for all chemicals coming into contact with the piping materials prior to use.

Number = Maximum Recommended Temp. (°F)\*\*      CF = Consult Factory      NR = Not Recommended      •• = Incomplete Data

Chemical Name	CAS #	Pipe & Fitting Materials Recommended Max. Temp (°F)			Seal Materials Recommended Max. Temp. (°F)		
		ABS	PVC	CPVC	Viton®	EPDM	
Ammonium Tartrate .....	3164-29-2	NR	NR	••	••	••	••
Ammonium Thiocyanate.....	1762-95-4	120	140	180	185	••	73
Amyl Acetate .....	628-63-7	NR	NR	NR	NR	73	NR
Amyl Chloride .....	Category	NR	NR	NR	200	NR	NR
Aniline .....	62-53-3	NR	NR	NR	NR	140	NR
Aniline Chlorohydrate.....	142-04-1	NR	NR	NR	185	••	NR
Aniline Hydrochloride.....	142-04-1	NR	NR	NR	185	••	NR
Anthraquinonesulfonic Acid .....	82-49-5	••	140	••	200	••	••
Anti-Freeze (See Alcohols Glycols and Glycerin) .	Category	NR	NR	NR	NR	NR	NR
Antimony Trichloride .....	10025-91-9	••	140	180	185	140	140
Aqua Regia .....	8007-56-5	NR	NR	73	100	NR	NR
Argon.....	7440-37-1	••	••	••	200	200	100
Aromatic Hydrocarbons.....	Category	NR	NR	NR	73	NR	NR
Arsenic Acid.....	7778-39-4	••	140	73	200	185	NR
Aryl Sulfonic Acid.....	Category	••	140	••	185	140	••
Asphalt .....	8052-42-4	NR	NR	NR	180	NR	NR
Barium Carbonate .....	513-77-9	120	140	180	200	200	160
Barium Chloride.....	10361-37-2	120	140	180	200	200	160
Barium Hydroxide .....	17194-00-2	120	140	180	200	180	150
Barium Nitrate.....	10022-31-8	120	73	180	200	200	160
Barium Sulfate.....	7727-43-7	120	140	180	200	200	160
Barium Sulfide.....	21109-95-5	120	140	180	200	140	160
Beer.....	8029-31-0	120	140	180	200	200	140
Beet Sugar Liquids.....	57-50-1	120	140	180	185	200	160
Benzaldehyde .....	100-52-7	NR	NR	NR	NR	200	NR
Benzalkonium Chloride.....	8001-54-5	NR	NR	NR	••	••	••
Benzene .....	71-43-2	NR	NR	NR	150	NR	NR
Benzene, Benzol .....	71-43-2	NR	NR	NR	150	NR	NR
Benzene Sulfonic Acid .....	98-11-3	NR	NR	NR	185	NR	100
Benzoic Acid .....	65-85-0	140	140	73	••	NR	160
Benzyl Alcohol .....	100-51-6	NR	NR	NR	140	NR	NR
Benzyl Chloride.....	100-44-7	NR	NR	NR	200	NR	NR
Biodiesel Fuel.....	Mixture	NR	73	NR	200	NR	NR
Bismuth Carbonate.....	5892-10-4	140	140	180	••	••	73
Black Liquor .....	Mixture	73	140	180	200	180	73

Acrylonitrile-Butadiene-Styrene Polyvinyl Chloride Type 1 Grade 1 Chlorinated Polyvinyl Chloride Type IV Grade 1  
 Fluorocarbon Elastomer (Viton® is a registered trademark of the DuPont Co.) Ethylene Propylene Diene Monomer  
 \*\* Maximum recommended temperature, for chemical resistance, under normal conditions. § Non-pressure, vent-only, applications when chemical is in gas form.  
 ‡ Must use solvent cement specially formulated for hypochlorite or caustic chemical service (IPS Weld-On 724 or equal).



# CHEMICAL RESISTANCE

The following table gives the chemical resistance of ABS, CPVC, and PVC thermoplastic piping materials and three commonly used seal materials. The information shown is based upon laboratory tests conducted by the manufacturers of the materials, and it is intended to provide a general guideline on the resistance of these materials to various chemicals. **NOTICE:** This table is not a guarantee, and any piping systems using products made of these materials should be tested under actual service conditions to determine their suitability for a particular purpose. See website for most current data: [www.charlottepipe.com](http://www.charlottepipe.com)

**CAUTION**

ABS, CPVC, and PVC piping systems have very different chemical resistance. Review manufacturer's literature for all chemicals coming into contact with the piping materials prior to use.

Number = Maximum Recommended Temp. (°F)\*\*      CF = Consult Factory      NR = Not Recommended      • • = Incomplete Data

Chemical Name	CAS #	Pipe & Fitting Materials Recommended Max. Temp (°F)			Seal Materials Recommended Max. Temp. (°F)		
		ABS	PVC	CPVC	Viton ®	EPDM	Neoprene
Bleach (5.5% Sodium Hypochlorite).....	7681-52-9	73	140‡	180	200	140	140
Bleach (12.5% Sodium Hypochlorite)....	7681-52-9	73	140‡	180	200	140	140
Borax.....	1303-96-4	140	140	NR	185	140	140
Boric Acid.....	10043-35-3	140	140	NR	185	140	140
Breeders Pellets, Deriv. Fish.....	Mixture	140	140	180	• •	• •	• •
Brine, Acid.....	Mixture	73	73	180	200	200	160
Bromic Acid.....	7789-31-3	73	140	180	73	73	• •
Bromine.....	7726-95-6	NR	NR	NR	73	NR	NR
Bromine, Liquid.....	7726-95-6	NR	NR	NR	73	NR	NR
Bromine, Vapor 25%.....	7726-95-6	NR	140	• •	• •	NR	• •
Bromine, Water.....	Mixture	NR	73	73	185	NR	NR
Bromine, Water, (Sat'd).....	Mixture	NR	73	73	• •	• •	• •
Bromobenzene.....	108-86-1	NR	NR	NR	150	NR	NR
Bromotoluene.....	Category	NR	NR	NR	NR	NR	NR
Butadiene.....	106-99-0	NR	140	73	185	NR	140
Butane.....	106-97-8	NR	140	• •	185	NR	73
Butanol.....	71-36-3	NR	NR	NR	• •	• •	• •
Butyl Acetate.....	123-86-4	NR	NR	NR	NR	140	NR
Butyl Alcohol.....	71-36-3	NR	NR	NR	• •	• •	• •
Butyl Carbitol.....	112-34-5	• •	• •	NR	• •	• •	• •
Butyl Cellosolve (2-butoxyethanol).....	111-76-2	NR	73	NR	NR	140	• •
Butyl Phenol.....	3180-09-4	NR	73	• •	• •	• •	NR
Butyl Pthalate.....	84-74-2	NR	NR	NR	73	• •	• •
Butyl Stearate.....	123-95-5	NR	73	73	200	NR	NR
Butylene.....	Category	NR	73	• •	NR	140	NR
Butynediol.....	110-65-6	NR	73	• •	• •	• •	• •
Butyric Acid.....	107-92-6	NR	NR	NR	73	140	NR
Cadmium Acetate.....	543-90-8	• •	• •	180	• •	• •	• •
Cadmium Chloride.....	10108-64-2	• •	• •	180	• •	• •	• •
Cadmium Cyanide.....	542-83-6	• •	140	180	• •	• •	73
Cadmium Sulfate.....	10124-36-4	• •	• •	180	• •	• •	• •
Caffeine Citrate.....	69-22-7	• •	73	• •	• •	• •	• •
Calcium Acetate.....	62-54-4	NR	73	180	• •	R	• •
Calcium Bisulfite.....	13780-03-5	NR	NR	180	185	• •	• •
Calcium Carbonate.....	471-34-1	140	140	180	200	200	73

Acrylonitrile-Butadiene-Styrene Polyvinyl Chloride Type 1 Grade 1 Chlorinated Polyvinyl Chloride Type IV Grade 1  
 Fluorocarbon Elastomer (Viton ® is a registered trademark of the DuPont Co.) Ethylene Propylene Diene Monomer  
 \*\* Maximum recommended temperature, for chemical resistance, under normal conditions. § Non-pressure, vent-only, applications when chemical is in gas form.  
 ‡ Must use solvent cement specially formulated for hypochlorite or caustic chemical service (IPS Weld-On 724 or equal).

# CHEMICAL RESISTANCE

The following table gives the chemical resistance of ABS, CPVC, and PVC thermoplastic piping materials and three commonly used seal materials. The information shown is based upon laboratory tests conducted by the manufacturers of the materials, and it is intended to provide a general guideline on the resistance of these materials to various chemicals. **NOTICE:** This table is not a guarantee, and any piping systems using products made of these materials should be tested under actual service conditions to determine their suitability for a particular purpose. See website for most current data: [www.charlottepipe.com](http://www.charlottepipe.com)

CAUTION

ABS, CPVC, and PVC piping systems have very different chemical resistance. Review manufacturer's literature for all chemicals coming into contact with the piping materials prior to use.

Number = Maximum Recommended Temp. (°F)\*\*      CF = Consult Factory      NR = Not Recommended      •• = Incomplete Data

Chemical Name	CAS #	Pipe & Fitting Materials Recommended Max. Temp (°F)			Seal Materials Recommended Max. Temp. (°F)		
		ABS	PVC	CPVC	Viton®	EPDM	Neoprene
Calcium Chlorate.....	10137-74-3	140	140	180	185	140	73
Calcium Chloride.....	10043-52-4	140	140	180	200	200	160
Calcium Hydroxide.....	1305-62-0	140	140‡	180‡	200	200	70
Calcium Hypochlorite.....	7778-54-3	140	140‡	180‡	185	73	••
Calcium Nitrate.....	10124-37-5	140	140	180	200	200	100
Calcium Oxide.....	1305-78-8	140	140	180	••	200	160
Calcium Sulfate.....	7778-18-9	140	140	180	200	200	160
Camphor.....	76-22-2	NR	73	••	200	200	NR
Cane Sugar Liquors.....	Category	120	140	180	200	200	160
Caprolactam.....	105-60-2	NR	••	NR	••	••	••
Caprolactone.....	502-44-3	NR	••	NR	••	••	••
Caprylic Acid.....	124-07-2	NR	••	NR	••	••	••
Carbitol™.....	111-90-0	NR	NR	NR	73	140	73
Carbon Bisulfide.....	75-15-0	NR	NR	NR	200	NR	NR
Carbon Dioxide, Dry.....	124-38-9	140	140	180	200	200	160
Carbon Dioxide, Wet.....	124-38-9	140	140	180	200	200	160
Carbon Disulfide.....	75-15-0	NR	NR	NR	200	NR	NR
Carbon Monoxide.....	630-08-0	140	140	180	200	200	73
Carbon Tetrachloride.....	56-23-5	NR	NR	NR	185	NR	NR
Carbonic Acid.....	463-79-6	••	140	180	200	200	73
ΔCastor Oil.....	8001-79-4	NR	140	NR	200	NR	200
Caustic Potash.....	1310-58-3	140	140	NR	NR	140	160
Caustic Soda.....	1310-73-2	140	140	CF	NR	70	100
Cellosolve.....	110-80-5	NR	73	NR	NR	140	••
Cellosolve Acetate.....	111-15-9	NR	••	NR	NR	140	NR
Chloracetyl Chloride.....	79-04-9	NR	73	••	••	••	••
Chloral Hydrate.....	302-17-0	••	140	180	NR	NR	73
Chloramine.....	10599-90-3	NR	73	NR	NR	NR	NR
Chloramine Water, (Sat'd).....	10599-90-3	••	140	180	200	73	••
Chloric Acid, 20%.....	7790-93-4	••	140	180	140	••	140
Chlorinated Solvents, Wet or Dry.....	Mixture	NR	NR	NR	200	NR	NR
Chlorinated Water, by Cl <sub>2</sub> Gas, Up to 3500 ppm	Mixture	140	140	NR	185	100	NR
Chlorinated Water, by Cl <sub>2</sub> Gas, Above 3500 ppm	Mixture	NR	NR	NR	185	NR	NR
Chlorinated Water, by Sodium Hypochlorite	Mixture	140	140	200	200	200	200
Chlorine Dioxide (sat'd aqueous sol.).....	10049-04-4	••	••	180	••	••	••
Chlorine Gas, Dry.....	7782-50-5	NR	NR	NR	185	NR	NR

Acrylonitrile-Butadiene-Styrene Polyvinyl Chloride Type 1 Grade 1 Chlorinated Polyvinyl Chloride Type IV Grade 1 Fluorocarbon Elastomer (Viton® is a registered trademark of the DuPont Co.) Ethylene Propylene Diene Monomer

\*\* Maximum recommended temperature, for chemical resistance, under normal conditions. † Non-pressure, vent-only, applications when chemical is in gas form.

ΔCastor oil may cause environmental stress cracking in high-stress areas such as plastic threaded connections.

‡ Must use solvent cement specially formulated for hypochlorite or caustic chemical service (IPS Weld-On 724 or equal).

# CHEMICAL RESISTANCE

The following table gives the chemical resistance of ABS, CPVC, and PVC thermoplastic piping materials and three commonly used seal materials. The information shown is based upon laboratory tests conducted by the manufacturers of the materials, and it is intended to provide a general guideline on the resistance of these materials to various chemicals. **NOTICE:** This table is not a guarantee, and any piping systems using products made of these materials should be tested under actual service conditions to determine their suitability for a particular purpose. See website for most current data:  
www.charlottepipe.com

**CAUTION**

ABS, CPVC, and PVC piping systems have very different chemical resistance. Review manufacturer's literature for all chemicals coming into contact with the piping materials prior to use.

Number = Maximum Recommended Temp. (°F)\*\*      CF = Consult Factory      NR = Not Recommended      •• = Incomplete Data

Chemical Name	CAS #	Pipe & Fitting Materials Recommended Max. Temp (°F)			Seal Materials Recommended Max. Temp. (°F)		
		ABS	PVC	CPVC	Viton ®	EPDM	Neoprene
Chlorine Gas, Wet .....	7782-50-5	NR	NR	NR	185	NR	NR
Chlorine Water, (Sat'd).....	Mixture	••	140	180	200	73	••
Chlorine, Liquid (See Sodium Hypochlorite)...	7782-50-5	NR	NR	NR	NR	NR	NR
Chlorine, trace in air.....	7782-50-5	••	••	180§	••	••	••
Chloroacetic Acid .....	79-11-8	73	73	180	NR	73	••
Chlorobenzene.....	108-90-7	NR	NR	NR	73	NR	NR
Chlorobenzoyl chloride.....	1321-03-5	NR	NR	NR	200	••	••
Chloroform.....	67-66-3	NR	NR	NR	73	NR	NR
Chloropicrin .....	76-06-2	NR	NR	NR	••	••	••
Chlorosulfonic Acid .....	7790-94-5	••	73	73	NR	NR	NR
Chromic Acid, 10% .....	7738-94-5	73	140‡	180‡	140	70	NR
Chromic Acid, 30% .....	7738-94-5	NR	73‡	180‡	140	NR	NR
Chromic Acid, 40% .....	7738-94-5	NR	73‡	180‡	140	NR	NR
Chromic Acid, 50% .....	7738-94-5	NR	73‡	140‡	140	NR	NR
Chromium Potassium Nitrate.....	Mixture	73	73	73	200	140	160
Chromium(3+) Nitrate.....	13548-38-4	••	••	180	••	••	••
Citric Acid (Sat'd) .....	77-92-9	140	140	180	200	200	140
Citrus Limon Oils .....	8008-56-8	••	••	NR	••	••	••
Coconut Oil .....	8001-31-8	NR	140	NR	185	NR	100
Coke Oven Gas.....	65996-81-8	NR	NR	NR	185	70	••
Copper Carbonate.....	1184-64-1	120	140	180	185	200	••
Copper Chloride.....	7447-39-4	73	140	180	200	200	160
Copper Cyanide .....	544-92-3	73	140	180	185	200	160
Copper Fluoride.....	7789-19-7	73	140	180	185	200	140
Copper Nitrate .....	3251-23-8	120	140	180	200	200	160
Copper Salts.....	Category	140	140	180	••	••	••
Copper Sulfate .....	7758-98-7	140	140	180	200	200	160
Copper(II) acetate monohydrate.....	6046-93-1	73	73	73	140	100	160
Corn Oil .....	8001-30-7	73	140	NR	200	NR	160
Corn Syrup.....	8029-43-4	120	140	180	185	••	140
Cottonseed Oil .....	8001-29-4	120	140	NR	185	NR	••
Creosote.....	8001-58-9	NR	NR	NR	73	NR	NR
Cresols.....	Category	NR	NR	NR	100	NR	NR
Cresylic Acid, 50% .....	1319-77-3	NR	140	NR	185	NR	NR
Crotonaldehyde.....	4170-30-3	NR	NR	NR	NR	NR	73

Acrylonitrile-Butadiene-Styrene Polyvinyl Chloride Type 1 Grade 1 Chlorinated Polyvinyl Chloride Type IV Grade 1  
Fluorocarbon Elastomer (Viton ® is a registered trademark of the DuPont Co.) Ethylene Propylene Diene Monomer  
\*\* Maximum recommended temperature, for chemical resistance, under normal conditions. § Non-pressure, vent-only, applications when chemical is in gas form.  
‡ Must use solvent cement specially formulated for hypochlorite or caustic chemical service (IPS Weld-On 724 or equal).

# CHEMICAL RESISTANCE

The following table gives the chemical resistance of ABS, CPVC, and PVC thermoplastic piping materials and three commonly used seal materials. The information shown is based upon laboratory tests conducted by the manufacturers of the materials, and it is intended to provide a general guideline on the resistance of these materials to various chemicals. **NOTICE:** This table is not a guarantee, and any piping systems using products made of these materials should be tested under actual service conditions to determine their suitability for a particular purpose. See website for most current data: [www.charlottepipe.com](http://www.charlottepipe.com)

CAUTION

ABS, CPVC, and PVC piping systems have very different chemical resistance. Review manufacturer's literature for all chemicals coming into contact with the piping materials prior to use.

Number = Maximum Recommended Temp. (°F)\*\*      CF = Consult Factory      NR = Not Recommended      •• = Incomplete Data

Chemical Name	CAS #	Pipe & Fitting Materials Recommended Max. Temp (°F)			Seal Materials Recommended Max. Temp. (°F)		
		ABS	PVC	CPVC	Viton ®	EPDM	Neoprene
Crude Oil.....	8002-05-9	NR	73	180	200	NR	NR
Cumene.....	98-82-8	••	••	••	200	NR	NR
Cupric Fluoride .....	7789-19-7	73	140	180	••	200	••
Cupric Sulfate .....	7758-98-7	140	140	180	200	200	160
Cuprous Chloride .....	7758-89-6	73	140	180	200	200	70
Cyclohexane .....	110-82-7	NR	NR	NR	185	NR	NR
Cyclohexanol .....	108-93-0	NR	NR	NR	185	NR	NR
Cyclohexanone.....	108-94-1	NR	NR	NR	NR	73	NR
D-Limonene.....	5989-27-5	••	••	NR	••	••	••
Decalin.....	91-17-8	NR	NR	NR	••	••	••
Desoxyephedrine.....	33817-09-3	••	73	••	••	••	••
Detergents w/non-ionic surfactants.....	Mixture	73	140	NR	200	200	160
Dextrin.....	9004-53-9	••	140	180	200	NR	••
Dextrose.....	50-99-7	120	140	180	200	140	160
Diacetone Alcohol.....	123-42-2	NR	NR	NR	NR	73	NR
Diazo Salts.....	Category	••	140	180	••	••	••
Dibutoxy Ethyl Phthalate.....	117-83-9	NR	NR	NR	200	73	NR
Dibutyl Ethyl Phthalate.....	Mixture	NR	NR	NR	200	73	NR
Dibutyl Phthalate.....	84-74-2	NR	NR	NR	NR	73	NR
Dibutyl Sebacate .....	109-43-3	NR	NR	NR	NR	73	NR
Dichlorobenzene .....	Category	NR	NR	NR	200	NR	NR
Dichloroethylene.....	Category	NR	NR	NR	200	NR	NR
Diesel Fuels.....	68476-34-6	NR	73	NR	200	NR	NR
Diethyl Cellosolve .....	629-14-1	NR	••	NR	200	NR	100
Diethyl Ether.....	60-29-7	NR	NR	NR	NR	NR	NR
Diethylamine .....	109-89-7	NR	NR	NR	NR	73	••
Diglycolic Acid .....	110-99-6	NR	140	••	73	73	••
Dill Oil .....	8006-75-5	••	••	NR	••	••	••
Dimethyl Hydrazine .....	57-14-7	NR	NR	NR	NR	••	••
Dimethylamine .....	124-40-3	NR	140	NR	NR	140	NR
Dimethylformamide .....	68-12-2	NR	NR	NR	NR	NR	NR
Diethyl Phthalate (DEHP).....	117-81-7	NR	NR	NR	73	73	NR
Dioxane.....	123-91-1	NR	NR	NR	NR	73	NR
Dioxane 1,4.....	123-91-1	NR	NR	NR	NR	73	••
Disodium Phosphate .....	7558-79-4	120	140	180	••	200	••

Acrylonitrile-Butadiene-Styrene Polyvinyl Chloride Type 1 Grade 1 Chlorinated Polyvinyl Chloride Type IV Grade 1 Fluorocarbon Elastomer (Viton ® is a registered trademark of the DuPont Co.) Ethylene Propylene Diene Monomer  
 \*\* Maximum recommended temperature, for chemical resistance, under normal conditions. § Non-pressure, vent-only, applications when chemical is in gas form.

# CHEMICAL RESISTANCE

The following table gives the chemical resistance of ABS, CPVC, and PVC thermoplastic piping materials and three commonly used seal materials. The information shown is based upon laboratory tests conducted by the manufacturers of the materials, and it is intended to provide a general guideline on the resistance of these materials to various chemicals. **NOTICE:** This table is not a guarantee, and any piping systems using products made of these materials should be tested under actual service conditions to determine their suitability for a particular purpose. See website for most current data: [www.charlottepipe.com](http://www.charlottepipe.com)

**CAUTION**

ABS, CPVC, and PVC piping systems have very different chemical resistance. Review manufacturer's literature for all chemicals coming into contact with the piping materials prior to use.

Number = Maximum Recommended Temp. (°F)\*\*      CF = Consult Factory      NR = Not Recommended      •• = Incomplete Data

Chemical Name	CAS #	Pipe & Fitting Materials Recommended Max. Temp (°F)			Seal Materials Recommended Max. Temp. (°F)		
		ABS	PVC	CPVC	Viton ®	EPDM	Neoprene
Distilled Water .....	7732-18-5	140	140	180	200	200	160
Divinylbenzene.....	1321-74-0	NR	NR	NR	200	NR	••
Dry Cleaning Fluid.....	Mixture	NR	NR	NR	200	NR	••
Dursban TC .....	Mixture	NR	••	NR	••	••	NR
EDTA Tetrasodium Salt Hydrate .....	10378-23-1	140	140	180	200	200	160
Epichlorohydrin.....	106-89-8	NR	NR	NR	••	••	••
Epsom Salt .....	7487-88-9	120	140	180	••	200	••
Esters .....	Category	NR	NR	NR	••	••	••
Ethanol, Up to 5%.....	64-17-5	73	140	180	••	200	160
Ethanol, Over 5% .....	64-17-5	NR	140	180	••	200	160
Ethers.....	Category	NR	NR	NR	NR	••	NR
Ethyl Acetate .....	141-78-6	NR	NR	NR	NR	73	NR
Ethyl Acetoacetate .....	141-97-9	NR	NR	NR	NR	100	••
Ethyl Acrylate.....	140-88-5	NR	NR	NR	NR	73	NR
Ethyl Benzene .....	100-41-4	NR	NR	NR	73	NR	NR
Ethyl Chloride .....	75-00-3	NR	NR	NR	140	73	73
Ethyl Chloroacetate .....	105-39-5	NR	NR	NR	••	••	••
Ethyl Ether .....	60-29-7	NR	NR	NR	NR	NR	NR
Ethylene Bromide.....	106-93-4	NR	NR	NR	73	NR	••
Ethylene Chlorohydrin .....	107-07-3	NR	NR	NR	NR	73	••
Ethylene Diamine .....	107-15-3	NR	NR	NR	••	73	73
Ethylene Dichloride .....	107-06-2	NR	NR	NR	120	NR	NR
Ethylene Glycol, Up to 50%.....	107-21-1	73	140	180	200	200	160
Ethylene Glycol, Over 50%.....	107-21-1	73	140	NR	200	200	160
Ethylene Monochloride .....	75-01-4	NR	NR	NR	70	••	NR
Ethylene Oxide .....	75-21-8	NR	NR	NR	NR	NR	NR
Fatty Acids.....	Category	140	140	73	185	NR	140
Ferric Acetate .....	1834-30-6	NR	73	180	••	••	••
Ferric Chloride .....	7705-08-0	120	140	180	200	200	160
Ferric Hydroxide .....	1309-33-7	140	140	180	180	180	100
Ferric Nitrate.....	10421-48-4	140	140	180	200	200	160
Ferric Sulfate.....	10028-22-5	140	140	180	185	200	140
Ferrous Chloride.....	7758-94-3	140	140	180	200	200	••
Ferrous Hydroxide.....	18624-44-7	140	73	180	180	180	••
Ferrous Nitrate .....	13520-68-8	140	73	140	200	180	160

Acrylonitrile-Butadiene-Styrene Polyvinyl Chloride Type 1 Grade 1 Chlorinated Polyvinyl Chloride Type IV Grade 1  
Fluorocarbon Elastomer (Viton ® is a registered trademark of the DuPont Co.) Ethylene Propylene Diene Monomer  
\*\* Maximum recommended temperature, for chemical resistance, under normal conditions. § Non-pressure, vent-only, applications when chemical is in gas form.

# CHEMICAL RESISTANCE

The following table gives the chemical resistance of ABS, CPVC, and PVC thermoplastic piping materials and three commonly used seal materials. The information shown is based upon laboratory tests conducted by the manufacturers of the materials, and it is intended to provide a general guideline on the resistance of these materials to various chemicals. **NOTICE:** This table is not a guarantee, and any piping systems using products made of these materials should be tested under actual service conditions to determine their suitability for a particular purpose. See website for most current data: [www.charlottepipe.com](http://www.charlottepipe.com)

CAUTION

ABS, CPVC, and PVC piping systems have very different chemical resistance. Review manufacturer's literature for all chemicals coming into contact with the piping materials prior to use.

Number = Maximum Recommended Temp. (°F)\*\*      CF = Consult Factory      NR = Not Recommended      •• = Incomplete Data

Chemical Name	CAS #	Pipe & Fitting Materials Recommended Max. Temp (°F)			Seal Materials Recommended Max. Temp. (°F)		
		ABS	PVC	CPVC	Viton®	EPDM	Neoprene
Ferrous Sulfate.....	13463-43-9	140	140	180	200	200	160
Fish Solubles.....	Mixture	140	140	180	73	NR	••
Fluoboric Acid.....	16872-11-0	••	140	73	140	140	160
Fluorine Gas.....	7782-41-4	NR	NR	NR	NR	NR	NR
Fluorosilicic Acid, 30% .....	16961-83-4	73	140	73	200	140	100
Formaldehyde, 35%.....	50-00-0	NR	140	NR	NR	140	140
Formalin (37% to 50% Formaldehyde)..	50-00-0	NR	140	NR	NR	140	140
Formic Acid, Up to 25%.....	64-18-6	••	73	180	NR	200	140
Formic Acid, Anhydrous.....	64-18-6	••	73	NR	NR	••	100
Freon F-11.....	75-69-4	••	140§	73§	73	NR	NR
Freon F-113.....	76-13-1	••	140§	••	130	NR	130
Freon F-114.....	76-14-2	••	140§	••	NR	NR	73
Freon F-12.....	75-71-8	••	140§	73§	NR	NR	130
Freon F-21.....	75-43-4	••	NR	NR	NR	NR	NR
Freon F-22.....	75-45-6	••	NR	NR	NR	NR	130
Fructose.....	57-48-7	120	140	180	200	175	160
Fruit Juices.....	Category	73	140	180	200	200	200
Furfural .....	98-01-1	NR	NR	NR	NR	140	73
Gallic Acid.....	149-91-7	••	140	73	185	73	73
Gas, Manufactured .....	8006-14-2	NR	73§	NR	••	••	••
Gas, Natural .....	8006-14-2	NR	140§	••	185	NR	140
Gasoline, Sour.....	86290-81-5	NR	NR	NR	73	NR	NR
Gasoline, Unleaded.....	86290-81-5	NR	NR	NR	200	NR	NR
Gelatin.....	9000-70-8	120	140	150	200	200	160
Gin .....	Mixture	NR	140	NR	••	••	••
Glucose.....	50-99-7	120	140	180	200	200	160
Glycerine.....	56-81-5	120	140	180	200	200	160
Glycerine, Glycerol .....	56-81-5	120	140	180	200	200	160
Glycol Ethers.....	Category	NR	140	NR	••	••	••
Glycol, Ethylene up to 50%.....	107-21-1	73	140	180	200	200	200
Glycol, Ethylene Over 50%.....	107-21-1	73	140	NR	200	200	200
Glycol, Polyethylene (Carbowax) .....	25322-68-3	••	140	140	200	180	73
Glycol, Polypropylene.....	25322-69-4	73	NR	NR	200	200	200
Glycol, Propylene, Up to 25% .....	25322-69-4	73	140	180	200	200	73
Glycol, Propylene, Up to 50% .....	25322-69-4	73	140	NR	200	200	73

Acrylonitrile-Butadiene-Styrene Polyvinyl Chloride Type 1 Grade 1 Chlorinated Polyvinyl Chloride Type IV Grade 1  
 Fluorocarbon Elastomer (Viton® is a registered trademark of the DuPont Co.) Ethylene Propylene Diene Monomer  
 \*\* Maximum recommended temperature, for chemical resistance, under normal conditions. § Non-pressure, vent-only, applications when chemical is in gas form.



# CHEMICAL RESISTANCE

The following table gives the chemical resistance of ABS, CPVC, and PVC thermoplastic piping materials and three commonly used seal materials. The information shown is based upon laboratory tests conducted by the manufacturers of the materials, and it is intended to provide a general guideline on the resistance of these materials to various chemicals. **NOTICE:** This table is not a guarantee, and any piping systems using products made of these materials should be tested under actual service conditions to determine their suitability for a particular purpose. See website for most current data: [www.charlottepipe.com](http://www.charlottepipe.com)

**CAUTION**

ABS, CPVC, and PVC piping systems have very different chemical resistance. Review manufacturer's literature for all chemicals coming into contact with the piping materials prior to use.

Number = Maximum Recommended Temp. (°F)\*\*    CF = Consult Factory    NR = Not Recommended    •• = Incomplete Data

Chemical Name	CAS #	Pipe & Fitting Materials Recommended Max. Temp (°F)			Seal Materials Recommended Max. Temp. (°F)		
		ABS	PVC	CPVC	Viton ®	EPDM	Neoprene
Glycolic Acid.....	79-14-1	••	140	NR	NR	••	73
Grape Sugar, Juice .....	50-99-7	73	140	180	185	200	160
Green Liquor.....	68131-30-6	140	140	180	••	150	70
Halocarbons Oils .....	Category	NR	NR	NR	200	NR	NR
Heptane .....	142-82-5	73	140	NR	185	NR	73
Hexane .....	110-54-3	NR	73	73	73	NR	73
Hexanol .....	Isomers	NR	100	NR	160	NR	73
Hydraulic Oil.....	Mixture	NR	73	••	200	NR	73
Hydrazine .....	302-01-2	NR	NR	NR	NR	70	••
Hydrobromic Acid, Dilute .....	10035-10-6	73	140	180	185	200	73
Hydrobromic Acid, 20% .....	10035-10-6	73	140	73	185	140	73
Hydrobromic Acid, 50% .....	10035-10-6	NR	140	73	185	140	73
Hydrochloric Acid, Dilute.....	7647-01-0	73	140	180	200	140	73
Hydrochloric Acid, 20%.....	7647-01-0	NR	140‡	180‡	200	140	73
Hydrochloric Acid Conc., 37% .....	7647-01-0	NR	140‡	180‡	160	100	73
Hydrocyanic Acid, 10% .....	74-90-8	140	140	••	185	200	••
Hydrofluoric Acid, <10%.....	7664-39-3	NR	140	140	150	73	100
Hydrofluoric Acid, 30% .....	7664-39-3	NR	73	140	200	NR	NR
Hydrofluoric Acid, 40% .....	7664-39-3	NR	73	NR	100	NR	NR
Hydrofluoric Acid, 50% .....	7664-39-3	NR	NR	NR	73	NR	NR
Hydrofluoric Acid, 100% .....	7664-39-3	NR	NR	NR	NR	NR	NR
Hydrofluosilicic Acid, 50% .....	16961-83-4	NR	140	140	200	140	••
Hydrogen .....	162303-51-7	140§	140§	73§	200	200	160
Hydrogen Cyanide.....	74-90-8	••	140	••	••	••	73
Hydrogen Fluoride.....	7664-39-3	NR	NR	NR	NR	73	NR
Hydrogen Peroxide, 36% .....	7722-84-1	NR	140	73	200	NR	NR
Hydrogen Peroxide, 50% .....	7722-84-1	NR	140	73	200	NR	NR
Hydrogen Peroxide, 90% .....	7722-84-1	NR	NR	NR	200	NR	NR
Hydrogen Peroxide, Dilute .....	7722-84-1	73	140	73	200	73	NR
Hydrogen Phosphide .....	7803-51-2	••	140	••	••	73	••
Hydrogen Sulfide, Aqueous Sol. ....	7783-06-4	••	140	180	140	100	NR
Hydrogen Sulfide, Dry .....	7783-06-4	••	140	180	140	100	NR
Hydroquinone .....	123-31-9	••	140	••	185	NR	NR
Hydrosilicofluoric acid.....	16961-83-4	73	140	73	200	140	100
Hydroxylamine Sulfate .....	10039-54-0	••	140	••	••	73	73

Acrylonitrile-Butadiene-Styrene Polyvinyl Chloride Type 1 Grade 1 Chlorinated Polyvinyl Chloride Type IV Grade 1  
 Fluorocarbon Elastomer (Viton ® is a registered trademark of the DuPont Co.) Ethylene Propylene Diene Monomer  
 \*\* Maximum recommended temperature, for chemical resistance, under normal conditions. § Non-pressure, vent-only, applications when chemical is in gas form.  
 ‡ Must use solvent cement specially formulated for hypochlorite or caustic chemical service (IPS Weld-On 724 or equal).

# CHEMICAL RESISTANCE

The following table gives the chemical resistance of ABS, CPVC, and PVC thermoplastic piping materials and three commonly used seal materials. The information shown is based upon laboratory tests conducted by the manufacturers of the materials, and it is intended to provide a general guideline on the resistance of these materials to various chemicals. **NOTICE:** This table is not a guarantee, and any piping systems using products made of these materials should be tested under actual service conditions to determine their suitability for a particular purpose. See website for most current data: [www.charlottepipe.com](http://www.charlottepipe.com)

**CAUTION**

ABS, CPVC, and PVC piping systems have very different chemical resistance. Review manufacturer's literature for all chemicals coming into contact with the piping materials prior to use.

Number = Maximum Recommended Temp. (°F)\*\*      CF = Consult Factory      NR = Not Recommended      •• = Incomplete Data

Chemical Name	CAS #	Pipe & Fitting Materials Recommended Max. Temp (°F)			Seal Materials Recommended Max. Temp. (°F)		
		ABS	PVC	CPVC	Viton ®	EPDM	Neoprene
Hypochlorous Acid.....	7790-92-3	73	140	NR	73	73	••
Iodine .....	7553-56-2	NR	NR	NR	73	73	NR
Iodine in Alcohol .....	Mixture	NR	NR	NR	••	••	••
Iodine Solution, 10%.....	7553-56-2	NR	NR	NR	200	150	••
Iron Salts.....	Category	••	••	180	••	••	••
Isooctane .....	540-84-1	NR	NR	NR	185	NR	73
Isopropanol .....	67-63-0	NR	140	NR	••	••	••
Isopropyl Alcohol .....	67-63-0	NR	140	NR	160	160	73
Isopropyl Ether .....	108-20-3	NR	NR	NR	NR	NR	NR
Jet Fuel.....	Mixture	NR	NR	NR	200	NR	NR
Kerosene .....	8008-20-6	NR	NR	NR	200	NR	73
Ketones.....	Category	NR	NR	NR	NR	NR	NR
Kraft Liquor.....	Mixture	73	140	180	100	••	73
Lactic Acid, 25%.....	50-21-5	NR	140	100	200	140	73
Lactic Acid, 80%.....	50-21-5	NR	100	73	200	140	73
Lard Oil .....	8016-28-2	73	140	NR	185	NR	73
Lauric Acid .....	143-07-7	••	140	••	100	••	••
Lauryl Chloride .....	112-52-7	••	140	••	200	140	••
Lead Acetate .....	301-04-2	••	140	180	NR	200	160
Lead Chloride.....	7758-95-4	••	140	180	140	NR	73
Lead Nitrate.....	10099-74-8	••	140	180	200	175	140
Lead Sulfate.....	7446-14-2	••	140	180	200	200	140
Lemon Oil .....	8008-56-8	••	140	NR	200	NR	73
Ligroine.....	8032-32-4	NR	NR	NR	100	••	73
Lime Sulfur.....	1344-81-6	••	140	180	185	200	100
Limonene .....	138-86-3	••	••	NR	••	••	••
Linoleic Acid.....	60-33-3	••	140	180	140	73	••
Linoleic Oil.....	Mixture	••	140	180	73	••	••
Linseed Oil .....	8001-26-1	73	140	NR	200	73	73
Linseed Oil, Blue .....	Mixture	73	73	NR	200	••	••
Liqueurs.....	Category	NR	140	NR	••	200	160
Lithium Bromide (Brine).....	7550-35-8	••	140	180	200	••	••
Lithium Chloride .....	7447-41-8	••	140	180	140	100	••
Lithium Sulfate .....	10377-48-7	••	140	180	••	••	••
Lubricating Oil, Petroleum Based.....	Mixture	NR	140	180	160	NR	NR

Acrylonitrile-Butadiene-Styrene Polyvinyl Chloride Type 1 Grade 1 Chlorinated Polyvinyl Chloride Type IV Grade 1  
 Fluorocarbon Elastomer (Viton ® is a registered trademark of the DuPont Co.) Ethylene Propylene Diene Monomer  
 \*\* Maximum recommended temperature, for chemical resistance, under normal conditions. § Non-pressure, vent-only, applications when chemical is in gas form.

# CHEMICAL RESISTANCE

The following table gives the chemical resistance of ABS, CPVC, and PVC thermoplastic piping materials and three commonly used seal materials. The information shown is based upon laboratory tests conducted by the manufacturers of the materials, and it is intended to provide a general guideline on the resistance of these materials to various chemicals. **NOTICE:** This table is not a guarantee, and any piping systems using products made of these materials should be tested under actual service conditions to determine their suitability for a particular purpose. See website for most current data: [www.charlottepipe.com](http://www.charlottepipe.com)

**CAUTION**

ABS, CPVC, and PVC piping systems have very different chemical resistance. Review manufacturer's literature for all chemicals coming into contact with the piping materials prior to use.

Number = Maximum Recommended Temp. (°F)\*\*    CF = Consult Factory    NR = Not Recommended    •• = Incomplete Data

Chemical Name	CAS #	Pipe & Fitting Materials Recommended Max. Temp (°F)			Seal Materials Recommended Max. Temp. (°F)		
		ABS	PVC	CPVC	Viton ®	EPDM	Neoprene
Lux Liquid .....	No CAS #	••	NR	••	••	••	••
Lye Solutions.....	Category	••	140	180	••	••	••
Machine Oil.....	Mixture	NR	140	180	140	NR	NR
Magnesium Carbonate .....	546-93-0	120	140	180	200	170	140
Magnesium Chloride .....	7786-30-3	120	140	180	170	160	160
Magnesium Citrate .....	3344-18-1	120	140	180	200	175	••
Magnesium Fluoride .....	7783-40-6	120	••	180	200	140	••
Magnesium Hydroxide .....	1309-42-8	120	140	180	200	200	••
Magnesium Nitrate.....	10377-60-3	120	140	180	••	200	••
Magnesium Oxide.....	1309-48-4	120	••	180	••	140	160
Magnesium Salts, Inorganic.....	Category	120	••	180	200	160	160
Magnesium Sulfate.....	7487-88-9	120	140	180	200	180	180
Maleic Acid.....	110-16-7	140	140	180	200	NR	73
Maleic Acid (Sat'd) .....	110-16-7	140	140	180	200	73	NR
Malic Acid .....	6915-15-7	140	140	180	••	••	••
Manganese Sulfate .....	7785-87-7	120	140	180	200	175	160
Mercuric Chloride.....	7487-94-7	••	140	140	185	200	140
Mercuric Cyanide .....	592-04-1	••	140	180	73	73	73
Mercuric Sulfate.....	7783-35-9	••	140	180	73	73	••
Mercurous Nitrate.....	10415-75-5	••	140	180	73	73	NR
Mercury .....	7439-97-6	••	140	180	185	200	140
Methane.....	74-82-8	140§	140§	180§	185	NR	73
Methanol.....	67-56-1	NR	140	140	NR	160	160
Methoxyethyl Oleate .....	111-10-4	NR	73	••	••	••	••
Methyl Amine.....	74-89-5	NR	NR	NR	100	73	73
Methyl Bromide.....	74-83-9	NR	NR	NR	185	NR	NR
Methyl Cellosolve .....	109-86-4	NR	NR	NR	NR	NR	NR
Methyl Chloride.....	74-87-3	NR	NR	NR	73	NR	NR
Methyl Chloroform .....	71-55-6	NR	NR	NR	73	NR	NR
Methyl Ethyl Ketone .....	78-93-3	NR	NR	NR	NR	NR	NR
Methyl Formate.....	107-31-3	NR	••	NR	NR	100	73
Methyl Isobutyl Ketone .....	108-10-1	NR	NR	NR	NR	NR	NR
Methyl Methacrylate .....	80-62-6	NR	NR	NR	NR	NR	NR
Methyl Sulfate.....	75-93-4	NR	73	73	••	••	••
Methyl Sulfuric Acid.....	75-93-4	NR	73	73	••	••	••

Acrylonitrile-Butadiene-Styrene Polyvinyl Chloride Type 1 Grade 1 Chlorinated Polyvinyl Chloride Type IV Grade 1  
Fluorocarbon Elastomer (Viton ® is a registered trademark of the DuPont Co.) Ethylene Propylene Diene Monomer  
\*\* Maximum recommended temperature, for chemical resistance, under normal conditions. § Non-pressure, vent-only, applications when chemical is in gas form.

# CHEMICAL RESISTANCE

The following table gives the chemical resistance of ABS, CPVC, and PVC thermoplastic piping materials and three commonly used seal materials. The information shown is based upon laboratory tests conducted by the manufacturers of the materials, and it is intended to provide a general guideline on the resistance of these materials to various chemicals. **NOTICE:** This table is not a guarantee, and any piping systems using products made of these materials should be tested under actual service conditions to determine their suitability for a particular purpose. See website for most current data: [www.charlottepipe.com](http://www.charlottepipe.com)

CAUTION

ABS, CPVC, and PVC piping systems have very different chemical resistance. Review manufacturer's literature for all chemicals coming into contact with the piping materials prior to use.

Number = Maximum Recommended Temp. (°F)\*\*      CF = Consult Factory      NR = Not Recommended      •• = Incomplete Data

Chemical Name	CAS #	Pipe & Fitting Materials Recommended Max. Temp (°F)			Seal Materials Recommended Max. Temp. (°F)		
		ABS	PVC	CPVC	Viton®	EPDM	Neoprene
Methylene Bromide.....	74-95-3	NR	NR	NR	73	NR	NR
Methylene Chloride.....	75-09-2	NR	NR	NR	73	NR	NR
Methylene Chlorobromide .....	74-97-5	NR	NR	NR	NR	NR	NR
Methylene Iodine .....	75-11-6	NR	NR	NR	••	200	••
Methylisobutyl Carbinol.....	108-11-2	NR	NR	NR	73	73	73
Milk.....	8049-98-7	140	140	73	200	200	200
Mineral Oil.....	8042-47-5	73	140	180	200	NR	73
Molasses .....	68476-78-8	120	140	180	185	100	150
Monochloroacetic Acid, 50% .....	79-11-8	73	140	73	70	NR	NR
Monoethanolamine .....	141-43-5	NR	NR	NR	185	70	NR
Motor Oil .....	Mixture	73	140	180	200	NR	NR
Muriatic Acid, Up to 37% HCl.....	7647-01-0	NR	140	180	160	100	73
n-Heptane .....	142-82-5	NR	NR	NR	200	NR	73
Naphtha.....	8030-30-6	NR	NR	NR	150	NR	NR
Naphthalene.....	91-20-3	NR	NR	NR	180	NR	NR
Natural Gas .....	8006-14-2	NR	140§	••	185	NR	140
Nickel Acetate.....	373-02-4	73	73	180	NR	73	••
Nickel Chloride.....	7718-54-9	73	140	180	200	200	160
Nickel Nitrate .....	13138-45-9	73	140	180	200	180	••
Nickel Sulfate .....	7786-81-4	73	140	180	200	200	160
Nicotine.....	54-11-5	NR	140	••	••	••	NR
Nicotinic Acid .....	59-67-6	NR	140	180	••	73	140
Nitric Acid, 10% .....	7697-37-2	NR	140‡	140‡	NR	73	73
Nitric Acid, 30% .....	7697-37-2	NR	140‡	140‡	NR	NR	NR
Nitric Acid, 40% .....	7697-37-2	NR	140‡	140‡	NR	NR	NR
Nitric Acid, 50% .....	7697-37-2	NR	73‡	100‡	NR	NR	NR
Nitric Acid, 70% .....	7697-37-2	NR	NR	73‡	NR	NR	NR
Nitric Acid, 100%.....	7697-37-2	NR	NR	NR	NR	NR	NR
Nitric Acid, Fuming.....	7697-37-2	NR	NR	NR	NR	NR	NR
Nitrobenzene.....	98-95-3	NR	NR	NR	73	NR	••
Nitroglycerin.....	55-63-0	NR	NR	NR	••	••	••
Nitroglcol.....	628-96-6	NR	NR	••	••	••	73
Nitrous Acid, 10%.....	7782-77-6	NR	73	••	100	••	••
Nitrous Oxide .....	10024-97-2	73§	73§	••	73	••	NR
Nonionic Surfactants.....	Category	140	140	NR	200	200	160

Acrylonitrile-Butadiene-Styrene Polyvinyl Chloride Type 1 Grade 1 Chlorinated Polyvinyl Chloride Type IV Grade 1  
 Fluorocarbon Elastomer (Viton® is a registered trademark of the DuPont Co.) Ethylene Propylene Diene Monomer  
 \*\* Maximum recommended temperature, for chemical resistance, under normal conditions. § Non-pressure, vent-only, applications when chemical is in gas form.  
 ‡ Must use solvent cement specially formulated for hypochlorite or caustic chemical service (IPS Weld-On 724 or equal).

# CHEMICAL RESISTANCE

The following table gives the chemical resistance of ABS, CPVC, and PVC thermoplastic piping materials and three commonly used seal materials. The information shown is based upon laboratory tests conducted by the manufacturers of the materials, and it is intended to provide a general guideline on the resistance of these materials to various chemicals. **NOTICE:** This table is not a guarantee, and any piping systems using products made of these materials should be tested under actual service conditions to determine their suitability for a particular purpose. See website for most current data: [www.charlottepipe.com](http://www.charlottepipe.com)

CAUTION

ABS, CPVC, and PVC piping systems have very different chemical resistance. Review manufacturer's literature for all chemicals coming into contact with the piping materials prior to use.

Number = Maximum Recommended Temp. (°F)\*\*      CF = Consult Factory      NR = Not Recommended      •• = Incomplete Data

Chemical Name	CAS #	Pipe & Fitting Materials Recommended Max. Temp (°F)			Seal Materials Recommended Max. Temp. (°F)		
		ABS	PVC	CPVC	Viton®	EPDM	Neoprene
Ocenol.....	84286-21-5	NR	••	••	••	••	••
Oils, Vegetable .....	Category	NR	140	NR	200	NR	••
Oleic Acid .....	112-80-1	140	140	180	185	73	73
Oleum .....	8014-95-7	NR	NR	NR	NR	NR	NR
Olive Oil .....	8001-25-0	73	140	NR	150	NR	NR
Oxalic Acid, 20% .....	144-62-7	73	140	180	100	150	100
Oxalic Acid, 50% .....	144-62-7	••	140	73	100	150	100
Oxalic Acid (Sat'd) .....	144-62-7	••	140	140	100	150	100
Oxygen.....	7782-44-7	140§	140§	180§	185	200	140
Ozonated Water.....	7732-18-5	••	73	180	NR	73	73
Ozone.....	10028-15-6	140§	140§	180§	185	200	NR
Palm Oil.....	8002-75-3	••	••	••	73	NR	••
Palmitic Acid, 10% .....	57-10-3	73	140	73	185	73	NR
Palmitic Acid, 70% .....	57-10-3	NR	NR	73	185	••	NR
Paraffin.....	8002-74-2	73	140	••	200	NR	140
Peanut Oil .....	8002-03-7	••	••	••	150	NR	••
Pentachlorophenol .....	87-86-5	NR	NR	NR	200	NR	NR
Peppermint Oil .....	8006-90-4	NR	73	73	73	73	73
Peracetic Acid, 40%.....	79-21-0	NR	NR	NR	••	••	••
Perchloric Acid, 10%.....	7601-90-3	NR	73	180	200	NR	140
Perchloric Acid, 70%.....	7601-90-3	NR	NR	180	200	NR	73
Perchloroethylene .....	127-18-4	NR	NR	NR	200	NR	NR
Petrolatum .....	8009-03-8	••	140	180	••	••	••
Petroleum Oils, Refined.....	Mixture	73	140	180	200	NR	••
Petroleum Oils, Sour.....	Mixture	••	73	180	200	NR	••
Phenol .....	108-95-2	NR	NR	NR	200	73	NR
Phenylhydrazine .....	100-63-0	NR	NR	NR	NR	NR	••
Phenylhydrazine Hydrochloride .....	59-88-1	NR	NR	NR	••	••	••
Phosgene, Gas .....	75-44-5	NR	NR	NR	NR	73	••
Phosgene, Liquid .....	75-44-5	NR	NR	NR	NR	73	••
Phosphoric Acid, 10% .....	7664-38-2	73	140‡	180‡	200	140	140
Phosphoric Acid, 50% .....	7664-38-2	NR	140‡	180‡	160	160	160
Phosphoric Acid, 85% .....	7664-38-2	NR	140‡	180‡	160	160	160
Phosphoric Anhydride .....	1314-56-3	••	73	73	••	••	••
Phosphorous Pentoxide .....	16752-60-6	••	73	180	200	200	••

Acrylonitrile-Butadiene-Styrene Polyvinyl Chloride Type 1 Grade 1 Chlorinated Polyvinyl Chloride Type IV Grade 1  
Fluorocarbon Elastomer (Viton® is a registered trademark of the DuPont Co.) Ethylene Propylene Diene Monomer  
\*\* Maximum recommended temperature, for chemical resistance, under normal conditions. § Non-pressure, vent-only, applications when chemical is in gas form.

# CHEMICAL RESISTANCE

The following table gives the chemical resistance of ABS, CPVC, and PVC thermoplastic piping materials and three commonly used seal materials. The information shown is based upon laboratory tests conducted by the manufacturers of the materials, and it is intended to provide a general guideline on the resistance of these materials to various chemicals. **NOTICE:** This table is not a guarantee, and any piping systems using products made of these materials should be tested under actual service conditions to determine their suitability for a particular purpose. See website for most current data: [www.charlottepipe.com](http://www.charlottepipe.com)

**CAUTION**

ABS, CPVC, and PVC piping systems have very different chemical resistance. Review manufacturer's literature for all chemicals coming into contact with the piping materials prior to use.

Number = Maximum Recommended Temp. (°F)\*\*      CF = Consult Factory      NR = Not Recommended      •• = Incomplete Data

Chemical Name	CAS #	Pipe & Fitting Materials Recommended Max. Temp (°F)			Seal Materials Recommended Max. Temp. (°F)		
		ABS	PVC	CPVC	Viton®	EPDM	Neoprene
Phosphorous, Red .....	7723-14-0	NR	70	••	••	••	••
Phosphorous, Yellow .....	12185-10-3	NR	73	••	••	••	••
Phosphorus Trichloride .....	7719-12-2	NR	NR	NR	••	••	NR
Photographic Solutions.....	Mixture	••	140	180	185	••	100
Phthalic Acid, 10%.....	88-99-3	73	73	••	140	••	NR
Picric Acid.....	88-89-1	NR	NR	NR	140	140	70
Pine Oil.....	8002-09-3	NR	NR	NR	73	73	NR
Plating Solutions, Brass.....	Mixture	••	140	180	140	140	140
Plating Solutions, Cadmium.....	Mixture	••	140	180	180	180	140
Plating Solutions, Chrome .....	Mixture	••	140	180	180	180	NR
Plating Solutions, Copper .....	Mixture	••	140	180	180	180	140
Plating Solutions, Gold.....	Mixture	••	140	180	180	73	73
Plating Solutions, Indium .....	Mixture	••	••	••	140	73	140
Plating Solutions, Lead.....	Mixture	••	140	180	180	180	140
Plating Solutions, Nickel .....	Mixture	••	140	180	180	180	140
Plating Solutions, Rhodium.....	Mixture	••	140	180	73	120	73
Plating Solutions, Silver .....	Mixture	••	140	180	140	120	140
Plating Solutions, Tin .....	Mixture	••	140	180	140	180	140
Plating Solutions, Zinc .....	Mixture	••	140	180	140	73	180
POE Oils (Polyolester) .....	Mixture	NR	NR	NR	NR	NR	NR
Polyethylene Glycol (Carbowax) .....	25322-68-3	••	140	140	200	180	73
Polypropylene Glycol.....	57-55-6	73	NR	NR	200	200	200
Potash.....	Category	140	140	180	200	170	160
Potassium Acetate .....	127-08-2	••	••	180	••	••	••
Potassium Alum .....	10043-67-1	••	140	180	200	200	160
Potassium Aluminum Sulfate .....	10043-67-1	••	140	180	200	200	160
Potassium Amyl Xanthate .....	2720-73-2	••	NR	••	••	••	••
Potassium Bicarbonate .....	298-14-6	140	140	180	200	170	160
Potassium Bichromate .....	7778-50-9	140	140	180	200	170	••
Potassium Bisulfate, Sat'd.....	7646-93-7	••	140	180	200	180	73
Potassium Borate .....	1332-77-0	140	140	180	200	200	••
Potassium Bromate .....	7758-01-2	140	140	180	200	••	140
Potassium Bromide.....	7758-02-3	140	140	180	200	170	160
Potassium Carbonate .....	584-08-7	140	140	180	200	170	160
Potassium Chlorate.....	3811-04-9	140	140	180	200	170	160

Acrylonitrile-Butadiene-Styrene Polyvinyl Chloride Type 1 Grade 1 Chlorinated Polyvinyl Chloride Type IV Grade 1  
 Fluorocarbon Elastomer (Viton® is a registered trademark of the DuPont Co.) Ethylene Propylene Diene Monomer  
 \*\* Maximum recommended temperature, for chemical resistance, under normal conditions. § Non-pressure, vent-only, applications when chemical is in gas form.  
 ‡ Must use solvent cement specially formulated for hypochlorite or caustic chemical service (IPS Weld-On 724 or equal).



# CHEMICAL RESISTANCE

The following table gives the chemical resistance of ABS, CPVC, and PVC thermoplastic piping materials and three commonly used seal materials. The information shown is based upon laboratory tests conducted by the manufacturers of the materials, and it is intended to provide a general guideline on the resistance of these materials to various chemicals. **NOTICE:** This table is not a guarantee, and any piping systems using products made of these materials should be tested under actual service conditions to determine their suitability for a particular purpose. See website for most current data: [www.charlottepipe.com](http://www.charlottepipe.com)

**CAUTION**

ABS, CPVC, and PVC piping systems have very different chemical resistance. Review manufacturer's literature for all chemicals coming into contact with the piping materials prior to use.

Number = Maximum Recommended Temp. (°F)\*\*    CF = Consult Factory    NR = Not Recommended    • • = Incomplete Data

Chemical Name	CAS #	Pipe & Fitting Materials Recommended Max. Temp (°F)			Seal Materials Recommended Max. Temp. (°F)		
		ABS	PVC	CPVC	Viton ®	EPDM	Neoprene
Potassium Chloride.....	7447-40-7	140	140	180	200	200	160
Potassium Chromate.....	7789-00-6	140	140	180	200	170	70
Potassium Cyanide.....	151-50-8	140	140	180	185	140	160
Potassium Dichromate.....	7778-50-9	140	140	180	200	170	• •
Potassium Ethyl Xanthate.....	140-89-6	• •	73	• •	• •	• •	• •
Potassium Ferricyanide.....	13746-66-2	140	140	180	140	140	150
Potassium Ferrocyanide.....	13943-58-3	140	140	180	140	140	150
Potassium Fluoride.....	7789-23-3	140	140	180	200	140	• •
Potassium Hydroxide, 25%.....	1310-58-3	73	140‡	180‡	NR	180	140
Potassium Hydroxide, 50%.....	1310-58-3	73	140‡	180‡	NR	180	NR
Potassium Hypochlorite.....	7778-66-7	• •	73‡	180‡	73	NR	• •
Potassium Iodide.....	7681-11-0	• •	73	180	180	140	160
Potassium Nitrate.....	7757-79-1	140	140	180	200	200	140
Potassium Perborate.....	13769-41-0	140	140	180	73	73	73
Potassium Perchlorate, (Sat'd).....	7778-74-7	140	140	180	150	140	• •
Potassium Permanganate, 10%.....	7722-64-7	140	140	180	140	200	100
Potassium Permanganate, 25%.....	7722-64-7	140	140	180	140	140	100
Potassium Persulfate, (Sat'd).....	7727-21-1	73	140	180	200	200	140
Potassium Phosphate.....	Category	73	• •	180	180	180	180
Potassium Sulfate.....	7778-80-5	73	140	180	200	200	140
Potassium Sulfite.....	10117-38-1	73	140	180	200	200	140
Potassium Tripolyphosphate.....	13845-36-8	• •	• •	180	100	• •	73
Propane.....	74-98-6	140§	140§	73§	73	NR	73
Propanol.....	71-23-8	NR	140	NR	200	200	140
Propargyl Alcohol.....	107-19-7	NR	140	NR	140	140	NR
Propionic Acid, Up to 2%.....	79-09-4	NR	• •	180	• •	• •	NR
Propionic Acid, Over 2%.....	79-09-4	NR	• •	NR	• •	• •	NR
Propyl Alcohol.....	71-23-8	NR	140	NR	200	200	140
Propylene Dichloride.....	78-87-5	NR	NR	NR	73	NR	NR
Propylene Glycol, Up to 25%.....	57-55-6	73	140	180	200	200	73
Propylene Glycol, Up to 50%.....	57-55-6	73	140	NR	200	200	73
Propylene Oxide.....	75-56-9	NR	NR	NR	NR	73	NR
Pyridine.....	110-86-1	NR	NR	NR	NR	73	NR
Pyrogalllic Acid.....	87-66-1	• •	73	• •	• •	• •	73
Pyruvonnitrile.....	631-57-2	NR	NR	NR	NR	NR	NR

Acrylonitrile-Butadiene-Styrene Polyvinyl Chloride Type 1 Grade 1 Chlorinated Polyvinyl Chloride Type IV Grade 1  
 Fluorocarbon Elastomer (Viton ® is a registered trademark of the DuPont Co.) Ethylene Propylene Diene Monomer  
 \*\* Maximum recommended temperature, for chemical resistance, under normal conditions. § Non-pressure, vent-only, applications when chemical is in gas form.  
 ‡ Must use solvent cement specially formulated for hypochlorite or caustic chemical service (IPS Weld-On 724 or equal).

# CHEMICAL RESISTANCE

The following table gives the chemical resistance of ABS, CPVC, and PVC thermoplastic piping materials and three commonly used seal materials. The information shown is based upon laboratory tests conducted by the manufacturers of the materials, and it is intended to provide a general guideline on the resistance of these materials to various chemicals. **NOTICE:** This table is not a guarantee, and any piping systems using products made of these materials should be tested under actual service conditions to determine their suitability for a particular purpose. See website for most current data: [www.charlottepipe.com](http://www.charlottepipe.com)

**CAUTION**

ABS, CPVC, and PVC piping systems have very different chemical resistance. Review manufacturer's literature for all chemicals coming into contact with the piping materials prior to use.

Number = Maximum Recommended Temp. (°F)\*\*      CF = Consult Factory      NR = Not Recommended      •• = Incomplete Data

Chemical Name	CAS #	Pipe & Fitting Materials Recommended Max. Temp (°F)			Seal Materials Recommended Max. Temp. (°F)		
		ABS	PVC	CPVC	Viton®		
Quaternary Ammonium Salts .....	Category	NR	140	NR	73	••	73
Radon Gas .....	10043-92-2	140§	140§	140§	200	200	200
Rayon Coagulating Bath .....	Mixture	••	140	NR	••	••	••
Reverse Osmosis Water .....	7732-18-5	140	140	180	200	200	200
Salicylaldehyde .....	90-02-8	NR	NR	••	••	••	••
Salicylic Acid .....	69-72-7	••	140	180	185	200	NR
Sea Water .....	Mixture	140	140	180	200	200	200
Sec-Butanol .....	78-92-2	NR	NR	NR	••	••	••
Selenic Acid .....	7783-08-6	••	140	••	NR	73	73
Silicic Acid .....	10193-36-9	••	140	••	200	140	140
Silicone Oil.....	63148-62-9	••	100	180	200	140	200
Silver Chloride .....	7783-90-6	140	••	180	73	73	73
Silver Cyanide .....	506-64-9	140	140	180	140	140	73
Silver Nitrate .....	7761-88-8	140	140	180	200	200	160
Silver Sulfate .....	10294-26-5	140	140	180	200	170	73
Soaps.....	Category	140	140	180	200	200	140
Sodium Acetate .....	127-09-3	120	140	180	NR	170	NR
Sodium Alum .....	7784-28-3	120	140	180	200	170	140
Sodium Aluminate.....	1302-42-7	120	••	180	200	200	140
Sodium Arsenate .....	10103-60-3	120	140	180	200	140	73
Sodium Benzoate.....	532-32-1	120	140	180	200	200	NR
Sodium Bicarbonate .....	144-55-8	120	140	180	200	200	160
Sodium Bichromate .....	10588-01-9	120	140	180	200	140	73
Sodium Bisulfate .....	7681-38-1	120	140	180	200	200	140
Sodium Bisulfite.....	7631-90-5	120	140	180	200	200	140
Sodium Borate .....	1303-96-4	120	73	180	140	140	100
Sodium Bromide.....	7647-15-6	120	140	180	200	200	73
Sodium Carbonate .....	497-19-8	120	140	180	200	140	140
Sodium Chlorate.....	7775-09-9	120	73	180	100	140	160
Sodium Chloride.....	7647-14-5	120	140	180	200	140	160
Sodium Chlorite .....	7758-19-2	120	NR	180	NR	NR	••
Sodium Chromate.....	7775-11-3	120	140	180	140	140	73
Sodium Cyanide.....	143-33-9	120	73	180	140	140	140
Sodium Dichromate.....	10588-01-9	120	140	180	200	140	NR
Sodium Ferricyanide.....	14217-21-1	120	140	180	140	140	••

Acrylonitrile-Butadiene-Styrene Polyvinyl Chloride Type 1 Grade 1 Chlorinated Polyvinyl Chloride Type IV Grade 1  
 Fluorocarbon Elastomer (Viton® is a registered trademark of the DuPont Co.) Ethylene Propylene Diene Monomer  
 \*\* Maximum recommended temperature, for chemical resistance, under normal conditions. § Non-pressure, vent-only, applications when chemical is in gas form.

# CHEMICAL RESISTANCE

The following table gives the chemical resistance of ABS, CPVC, and PVC thermoplastic piping materials and three commonly used seal materials. The information shown is based upon laboratory tests conducted by the manufacturers of the materials, and it is intended to provide a general guideline on the resistance of these materials to various chemicals. **NOTICE:** This table is not a guarantee, and any piping systems using products made of these materials should be tested under actual service conditions to determine their suitability for a particular purpose. See website for most current data: [www.charlottepipe.com](http://www.charlottepipe.com)

**CAUTION**

ABS, CPVC, and PVC piping systems have very different chemical resistance. Review manufacturer's literature for all chemicals coming into contact with the piping materials prior to use.

Number = Maximum Recommended Temp. (°F)\*\*    CF = Consult Factory    NR = Not Recommended    •• = Incomplete Data

Chemical Name	CAS #	Pipe & Fitting Materials Recommended Max. Temp (°F)			Seal Materials Recommended Max. Temp. (°F)		
		ABS	PVC	CPVC	Viton®	EPDM	Neoprene
Sodium Ferrocyanide.....	13601-19-9	120	140	180	140	140	••
Sodium Fluoride.....	7681-49-4	120	73	180	140	140	73
Sodium Formate.....	141-53-7	••	••	180	••	••	••
Sodium Hydroxide, 15%.....	1310-73-2	120	140‡	NR	NR	180	160
Sodium Hydroxide, 30%.....	1310-73-2	73	73‡	NR	NR	140	160
Sodium Hydroxide, 50%.....	1310-73-2	73	73‡	NR	NR	140	160
Sodium Hydroxide, 70%.....	1310-73-2	NR	73‡	NR	NR	140	160
Sodium Hypobromite.....	13824-96-9	••	••	180	••	••	••
Sodium Hypochlorite, Sat'd, 12.5%.....	7681-52-9	NR	73‡	180‡	140	NR	NR
Sodium Iodide.....	7681-82-5	••	••	180	140	140	140
Sodium Metaphosphate.....	10124-56-8	120	73	180	73	73	••
Sodium Nitrate.....	7631-99-4	120	140	180	200	200	140
Sodium Nitrite.....	7632-00-0	120	140	180	200	170	140
Sodium Palmitate.....	408-35-5	••	140	180	••	••	••
Sodium Perborate.....	7632-04-4	120	140	180	73	73	73
Sodium Perchlorate.....	7601-89-0	120	140	180	••	••	••
Sodium Peroxide.....	1313-60-6	NR	140	180	185	140	73
Sodium Phosphate, Acid.....	7632-05-5	73	140	180	200	170	140
Sodium Phosphate, Alkaline.....	7632-05-5	73	140	180	200	170	140
Sodium Phosphate, Neutral.....	7632-05-5	73	140	180	200	170	140
Sodium Silicate.....	1344-09-8	••	••	180	200	200	140
Sodium Sulfate.....	Multiple CAS	73	140	180	200	140	140
Sodium Sulfide.....	1313-82-2	73	140	180	200	140	140
Sodium Sulfite.....	7757-83-7	73	140	180	200	140	140
Sodium Thiosulfate.....	7772-98-7	73	140	180	200	200	160
Sodium Tripolyphosphate.....	7758-29-4	••	••	180	••	••	••
Sour Crude Oil.....	8002-05-9	NR	73	180	200	NR	NR
Soybean Oil.....	8001-22-7	NR	140	180	200	NR	73
Soybean Oil, Epoxidized.....	8001-22-7	NR	NR	NR	200	NR	NR
Stannic Chloride.....	7646-78-8	120	140	180	200	100	NR
Stannous Chloride.....	7772-99-8	120	140	180	200	73	160
Stannous Sulfate.....	7488-55-3	••	••	180	••	••	••
Starch.....	9005-25-8	140	140	180	200	170	160
Stearic Acid.....	57-11-4	••	140	73	100	NR	73
Stoddard's Solvent.....	8052-41-3	NR	NR	NR	185	NR	NR

Acrylonitrile-Butadiene-Styrene Polyvinyl Chloride Type 1 Grade 1 Chlorinated Polyvinyl Chloride Type IV Grade 1  
 Fluorocarbon Elastomer (Viton® is a registered trademark of the DuPont Co.) Ethylene Propylene Diene Monomer  
 \*\* Maximum recommended temperature, for chemical resistance, under normal conditions. § Non-pressure, vent-only, applications when chemical is in gas form.  
 ‡ Must use solvent cement specially formulated for hypochlorite or caustic chemical service (IPS Weld-On 724 or equal).

# CHEMICAL RESISTANCE

The following table gives the chemical resistance of ABS, CPVC, and PVC thermoplastic piping materials and three commonly used seal materials. The information shown is based upon laboratory tests conducted by the manufacturers of the materials, and it is intended to provide a general guideline on the resistance of these materials to various chemicals. **NOTICE:** This table is not a guarantee, and any piping systems using products made of these materials should be tested under actual service conditions to determine their suitability for a particular purpose. See website for most current data: [www.charlottepipe.com](http://www.charlottepipe.com)

CAUTION

ABS, CPVC, and PVC piping systems have very different chemical resistance. Review manufacturer's literature for all chemicals coming into contact with the piping materials prior to use.

Number = Maximum Recommended Temp. (°F)\*\*      CF = Consult Factory      NR = Not Recommended      •• = Incomplete Data

Chemical Name	CAS #	Pipe & Fitting Materials Recommended Max. Temp (°F)			Seal Materials Recommended Max. Temp. (°F)		
		ABS	PVC	CPVC	Viton®	EPDM	Neoprene
Strontium Chloride.....	10476-85-4	••	••	180	••	••	••
Styrene Monomer.....	100-42-5	NR	NR	NR	NR	NR	NR
Succinic Acid.....	110-15-6	••	140	••	73	73	••
Sugar Syrup.....	Mixture	73	140	180	180	180	••
Sulfamic Acid.....	5329-14-6	NR	NR	180	NR	NR	73
Sulfate Liquors.....	Category	••	••	••	73	73	••
Sulfite Liquors.....	Category	••	••	180	140	140	73
Sulfur.....	7704-34-9	••	140	73	200	••	73
Sulfur Chloride.....	10545-99-0	NR	NR	180	140	NR	NR
Sulfur Dioxide, Dry.....	7446-09-5	73§	140§	NR	100	73	NR
Sulfur Dioxide, Wet.....	7446-09-5	73§	73§	NR	140	140	••
Sulfur Trioxide.....	7446-11-9	••	140	180	140	73	NR
Sulfur Trioxide, Gas.....	7446-11-9	140§	140§	••	140	73	NR
Sulfuric Acid, 10%.....	7664-93-9	120	140‡	180‡	200	140	160
Sulfuric Acid, 20%.....	7664-93-9	120	140‡	180‡	200	140	160
Sulfuric Acid, 30%.....	7664-93-9	NR	140‡	180‡	200	200	160
Sulfuric Acid, 50%.....	7664-93-9	NR	140‡	180‡	200	200	160
Sulfuric Acid, 60%.....	7664-93-9	NR	140‡	180‡	200	200	73
Sulfuric Acid, 70%.....	7664-93-9	NR	140‡	180‡	200	NR	NR
Sulfuric Acid, 80%.....	7664-93-9	NR	73‡	180‡	180	NR	NR
Sulfuric Acid, 90%.....	7664-93-9	NR	NR	140‡	160	NR	NR
Sulfuric Acid, 93%.....	7664-93-9	NR	NR	73‡	160	NR	NR
Sulfuric Acid, 98%.....	7664-93-9	NR	NR	73‡	160	NR	NR
Sulfuric Acid, 100%.....	7664-93-9	NR	NR	NR	160	NR	NR
Sulfurous Acid.....	7782-99-2	NR	140	180	NR	NR	NR
Surfactants, Nonionic.....	Category	140	140	NR	200	200	160
Tall Oil.....	8002-26-4	••	140	180	73	NR	73
Tannic Acid, 10%.....	1401-55-4	NR	140	180	100	73	100
Tannic Acid, 30%.....	1401-55-4	NR	73	73	••	••	••
Tanning Liquors.....	Category	140	140	180	200	••	73
Tar.....	8007-45-2	NR	NR	NR	185	NR	73
Tartaric Acid.....	526-83-0	140	73	73	73	NR	73
Terpenes.....	Category	NR	••	NR	••	••	••
Tetrachloroethylene.....	127-18-4	NR	NR	NR	200	NR	NR
Tetraethyl Lead.....	78-00-2	NR	73	••	73	NR	••

Acrylonitrile-Butadiene-Styrene Polyvinyl Chloride Type 1 Grade 1 Chlorinated Polyvinyl Chloride Type IV Grade 1  
 Fluorocarbon Elastomer (Viton® is a registered trademark of the DuPont Co.) Ethylene Propylene Diene Monomer  
 \*\* Maximum recommended temperature, for chemical resistance, under normal conditions. § Non-pressure, vent-only, applications when chemical is in gas form.  
 ‡ Must use solvent cement specially formulated for hypochlorite or caustic chemical service (IPS Weld-On 724 or equal).

# CHEMICAL RESISTANCE

The following table gives the chemical resistance of ABS, CPVC, and PVC thermoplastic piping materials and three commonly used seal materials. The information shown is based upon laboratory tests conducted by the manufacturers of the materials, and it is intended to provide a general guideline on the resistance of these materials to various chemicals. **NOTICE:** This table is not a guarantee, and any piping systems using products made of these materials should be tested under actual service conditions to determine their suitability for a particular purpose. See website for most current data: [www.charlottepipe.com](http://www.charlottepipe.com)

**CAUTION**

ABS, CPVC, and PVC piping systems have very different chemical resistance. Review manufacturer's literature for all chemicals coming into contact with the piping materials prior to use.

Number = Maximum Recommended Temp. (°F)\*\*    CF = Consult Factory    NR = Not Recommended    •• = Incomplete Data

Chemical Name	CAS #	Pipe & Fitting Materials Recommended Max. Temp (°F)			Seal Materials Recommended Max. Temp. (°F)		
		ABS	PVC	CPVC	Viton ®	EPDM	Neoprene
Tetrahydrofuran.....	109-99-9	NR	NR	NR	NR	NR	NR
Tetralin .....	119-64-2	NR	NR	NR	NR	NR	NR
Tetrasodium pyrophosphate.....	7722-88-5	••	140	180	••	••	••
Texanol .....	25265-77-4	••	••	NR	••	••	••
Thionyl Chloride.....	7719-09-7	NR	NR	NR	••	••	NR
Thread Cutting Oils.....	Category	73	73	••	73	NR	••
Titanium Tetrachloride.....	7550-45-0	NR	NR	NR	185	NR	NR
Toluene, Toluol.....	108-88-3	NR	NR	NR	73	NR	NR
Toluene-Kerosene, 25%-75%.....	Mixture	NR	NR	NR	73	NR	NR
Tomato Juice.....	Mixture	73	73	73	200	200	140
Toxaphene-Xylene, 90%-100%.....	Mixture	NR	NR	NR	73	NR	NR
Transformer Oil .....	Category	NR	140	180	200	NR	73
Transmission Fluid, Type A.....	Mixture	NR	NR	180	200	NR	73
Tributyl Citrate.....	77-94-1	NR	NR	NR	NR	73	73
Tributyl Phosphate.....	126-73-8	NR	NR	NR	NR	73	NR
Trichloroacetic Acid, <20%.....	76-03-9	NR	140	NR	NR	NR	NR
Trichloroethane .....	Category	NR	NR	NR	185	NR	NR
Trichloroethylene .....	79-01-6	NR	NR	NR	185	NR	NR
Triethanolamine.....	102-71-6	73	73	73	NR	160	NR
Triethylamine .....	121-44-8	NR	73	NR	200	160	73
Trimethylpropane.....	77-99-6	NR	73	••	••	180	160
Trisodium Phosphate.....	7601-54-9	73	140	180	185	73	73
Turpentine .....	9005-90-7	NR	140	NR	150	NR	NR
Urea .....	57-13-6	73	140	NR	185	200	140
Urine .....	Mixture	140	140	180	73	200	140
Vaseline .....	8009-03-8	NR	NR	NR	73	NR	140
Vegetable Oil.....	68956-68-3	73	140	NR	200	NR	73
Vinegar.....	64-19-7	120	140‡	180‡	73	200	NR
Vinyl Acetate .....	108-05-4	NR	NR	NR	NR	73	NR
Water .....	7732-18-5	140	140	180	200	200	160
Water, Acid Mine .....	7732-18-5	140	140	180	••	200	200
Water, Deionized .....	7732-18-5	140	140	180	200	200	200
Water, Demineralized .....	7732-18-5	140	140	180	200	200	200
Water, Distilled .....	7732-18-5	140	140	180	200	200	200
Water, Potable .....	7732-18-5	140	140	180	200	200	200

Acrylonitrile-Butadiene-Styrene Polyvinyl Chloride Type 1 Grade 1 Chlorinated Polyvinyl Chloride Type IV Grade 1 Fluorocarbon Elastomer (Viton ® is a registered trademark of the DuPont Co.) Ethylene Propylene Diene Monomer

\*\* Maximum recommended temperature, for chemical resistance, under normal conditions. ‡ Non-pressure, vent-only, applications when chemical is in gas form.

# CHEMICAL RESISTANCE

The following table gives the chemical resistance of ABS, CPVC, and PVC thermoplastic piping materials and three commonly used seal materials. The information shown is based upon laboratory tests conducted by the manufacturers of the materials, and it is intended to provide a general guideline on the resistance of these materials to various chemicals. **NOTICE:** This table is not a guarantee, and any piping systems using products made of these materials should be tested under actual service conditions to determine their suitability for a particular purpose. See website for most current data: [www.charlottepipe.com](http://www.charlottepipe.com)

CAUTION

ABS, CPVC, and PVC piping systems have very different chemical resistance. Review manufacturer's literature for all chemicals coming into contact with the piping materials prior to use.

Number = Maximum Recommended Temp. (°F)\*\*      CF = Consult Factory      NR = Not Recommended      •• = Incomplete Data

Chemical Name	CAS #	Pipe & Fitting Materials Recommended Max. Temp (°F)			Seal Materials Recommended Max. Temp. (°F)		
		ABS	PVC	CPVC	Viton®	EPDM	Neoprene
Water, Salt .....	7732-18-5	140	140	180	200	200	200
Water, Sea .....	7732-18-5	140	140	180	200	200	200
Water, Sewage .....	7732-18-5	140	140	180	200	200	200
Water, Spa .....	7732-18-5	NR	140	180	200	200	200
Water, Swimming Pool .....	7732-18-5	140	140	180	200	200	200
WD 40 .....	Mixture	NR	••	NR	••	••	••
Whiskey .....	Mixture	NR	140	180	140	200	140
White Liquor .....	68131-33-9	73	140	180	180	200	140
Wines .....	Mixture	NR	140	180	140	170	140
Xylene .....	1330-20-7	NR	NR	NR	150	NR	NR
Zinc Acetate .....	557-34-6	••	140	180	73	180	160
Zinc Bromide .....	7699-45-8	••	140	180	••	••	••
Zinc Carbonate .....	3486-35-9	120	••	180	73	73	73
Zinc Chloride .....	7646-85-7	120	140	180	200	180	180
Zinc Nitrate .....	7779-88-6	120	140	180	200	180	••
Zinc Phosphate .....	7779-90-0	••	••	180	73	73	73
Zinc Sulfate .....	7733-02-0	••	140	180	200	180	140

In most cases CAS numbers define one specific chemical with a specific chemical structure. Mixtures of several chemicals, categories of chemicals, metal alloys, and chemical Isomers will not have a specific CAS number. Instead they could contain multiple CAS numbers or none at all.

Acrylonitrile-Butadiene-Styrene Polyvinyl Chloride Type 1 Grade 1 Chlorinated Polyvinyl Chloride Type IV Grade 1  
 Fluorocarbon Elastomer (Viton® is a registered trademark of the DuPont Co.) Ethylene Propylene Diene Monomer  
 \*\* Maximum recommended temperature, for chemical resistance, under normal conditions. § Non-pressure, vent-only, applications when chemical is in gas form.



## Reference Standards Plastics

### ASTM TITLE

---

- ASTM D 635** Standard Test Method for Rate of Burning and/or Extent and Time of Burning of Plastics in a Horizontal Position  
SCOPE: This fire-test-response test method covers a small-scale laboratory screening procedure for comparing the relative linear rate of burning or extent and time of burning, or both, of plastics in the horizontal position.
- ASTM D 1784** Specification for Rigid Poly (Vinyl Chloride) (PVC) Compounds and Chlorinated Poly (Vinyl Chloride) (CPVC) Compounds  
SCOPE: This specification covers rigid PVC and CPVC compounds intended for general purpose use in extruded or molded form.
- ASTM D 1785** Specification for Poly (Vinyl Chloride) (PVC) Plastic Pipe, Schedule 40, 80, and 120  
SCOPE: This specification covers PVC pipe in Schedule 40, 80, and 120 for pressure applications. This system is intended for pressure applications where the operating temperature will not exceed 140 degrees fahrenheit.
- ASTM D 2235** Specification for Solvent Cement for Acrylonitrile-Butadiene-Styrene (ABS) Plastic Pipe and Fittings  
SCOPE: This specification covers solvent cement for joining (ABS) pipe and fittings for non-pressure systems.
- ASTM D 2241** Specifications for Poly (Vinyl Chloride) (PVC) Pipe Pressure-Rated (SDR-Series)  
SCOPE: This specification covers (PVC) pipe made in standard thermoplastic pipe dimension ratios (SDR Series) and Pressure Rated for Water.
- ASTM D 2321** Standard Practice for Underground Installation of Thermoplastic Pipe for Sewers and Other Gravity-Flow Applications  
SCOPE: This practice provides recommendations for the installation of buried thermoplastic pipe used in sewers and other gravity-flow applications (non-pressure applications).
- ASTM D 2464** Specifications for Threaded Poly (Vinyl Chloride) (PVC) Plastic Pipe Fittings, Schedule 80  
SCOPE: This specification covers (PVC) threaded Schedule 80 fittings which are used with the distribution of pressurized liquids only. CPVC threaded Schedule 80 fittings are now covered by ASTM F 437.
- ASTM D 2466** Specifications for Poly (Vinyl Chloride) (PVC) Plastic Pipe Fittings, Schedule 40  
SCOPE: This specification covers (PVC) Schedule 40 fittings used for distribution of pressurized liquids only.
- ASTM D 2564** Specifications for Solvent Cements for Poly (Vinyl Chloride) (PVC) Plastic Pipe and Fittings  
SCOPE: This specification covers requirements for (PVC) solvent cements to be used in joining (PVC) piping systems.
- ASTM D 2661** Specifications for Acrylonitrile-Butadiene-Styrene (ABS) Schedule 40 Plastic Drain, Waste, and Vent Pipe and Fittings  
SCOPE: This specification covers fittings and single extruded (solid wall) (ABS) plastic drain, waste, and vent pipe made to Schedule 40 iron pipe sizes.
- ASTM D 2665** Specifications for Poly (Vinyl Chloride) (PVC) Plastic Drain, Waste, and Vent Pipe and Fittings  
SCOPE: This specification covers requirements for (PVC) plastic drain, waste, and vent pipe and fittings suitable for the drainage and venting of sewage and certain other liquid waste.

## Reference Standards Plastics

### ASTM TITLE

---

- ASTM D 2729** Specifications for Poly (Vinyl Chloride) (PVC) Sewer Pipe and Fittings "Sewer and Drain"  
SCOPE: This specification covers requirements for (PVC) sewer pipe and fittings. The pipe and fittings in this specification are designed for sewer and drainage applications outside the building.
- ASTM D 2846** Specifications for Chlorinated Poly (Vinyl Chloride) (CPVC) Plastic Hot and Cold Water Distribution System  
SCOPE: This specification covers requirements for (CPVC) plastic hot and cold water distribution system components made in one standard dimension ratio and intended for water service up to and including 180 degrees fahrenheit.
- ASTM D 2949** Specifications for 3.25-in. Outside Diameter Poly (Vinyl Chloride) (PVC) Plastic Drain, Waste, and Vent Pipe and Fittings  
SCOPE: The requirements of this specification are intended to provide pipe and fittings suitable for drainage of sewage and certain other liquid waste.
- ASTM D 3034** Specifications for Type PMS Poly (Vinyl Chloride) (PVC) Sewer Pipe and Fittings SDR 35  
SCOPE: The requirements of this specification are intended to provide pipe and fittings suitable for non-pressure drainage of sewage and other surface water.
- ASTM D 3212** Specifications for Joints for Drain and Sewer Plastic Pipes Using Flexible Elastomeric Seals  
SCOPE: This specification covers joints for plastic pipe systems through compression of an elastomeric seal or ring.
- ASTM D 3311** Specification for Drain, Waste and Vent (DWV) Plastic Fitting Patterns  
SCOPE: This specification provides standard fitting geometries and laying lengths for plastic fittings intended for use in drain, waste, and vent applications.
- ASTM D 3965** Specifications for Rigid Acrylonitrile-Butadiene-Styrene (ABS) Material for Pipe and Fittings  
SCOPE: This specification covers materials made from only virgin ABS polymers and blends of ABS polymers suitable for use in the extrusion of pipe and molded fittings.
- ASTM D 4396** Specifications for Rigid Poly (Vinyl Chloride) (PVC) and Related Plastic Compounds for Non-pressure Piping Products  
SCOPE: The requirements of this specification are intended for the quality control of compounds used to manufacture pipe and fittings intended for non-pressure use.
- ASTM F 437** Specification for Threaded Chlorinated Poly (Vinyl Chloride) (CPVC) Plastic Pipe Fitting, Schedule 80  
SCOPE: This specification covers CPVC threaded Schedule 80 fittings, intended for use with iron pipe size (IPS) outside diameter plastic pipe.
- ASTM F 439** Specification for Chlorinated Poly (Vinyl Chloride) (CPVC) Plastic Pipe Fitting, Schedule 80  
SCOPE: This specification covers Schedule 80 CPVC fittings, intended for use with iron pipe size (IPS) outside diameter plastic pipe.
- ASTM F 441** Specifications for Chlorinated Poly (Vinyl Chloride) (CPVC) Plastic Pipe, Schedule 40 and Schedule 80  
SCOPE: This specification covers CPVC pipe made in Schedule 80 sizes and pressure rated for water.

## Reference Standards Plastics

### ASTM TITLE

---

- ASTM F 477** Specifications for Elastomeric Seals (Gaskets) for Joining Plastic Pipe  
SCOPE: This specification covers elastomeric seals (gaskets) used to seal the joint of plastic pipe used for gravity application.
- ASTM F 480** Specification for Thermoplastic Well Casing Pipe and Couplings Made in Standard Dimension Ratios (SDR), Schedule 40 and Schedule 80  
SCOPE: This specification covers water well casing pipe and couplings made from thermoplastic material in Standard Dimension Ratios (SDR), Schedule 40 and Schedule 80.
- ASTM F 493** Specification for Solvent Cements for Chlorinated Poly (Vinyl Chloride) (CPVC) Plastic Pipe and Fittings  
SCOPE: This specification provides requirements for CPVC solvent cement to be used in joining CPVC pipe and socket-type fittings.
- ASTM F 628** Specification for Acrylonitrile-Butadiene-Styrene (ABS) Schedule 40 Plastic Drain, Waste, and Vent Pipe with a Cellular Core  
SCOPE: This specification covers coextruded ABS plastic drain, waste, and vent pipe made to Schedule 40 iron pipe size (IPS).
- ASTM F 656** Specification for Primers for Use in Solvent Cement Joints of Poly (Vinyl Chloride) (PVC) Plastic Pipe and Fittings  
SCOPE: This specification covers requirements for primers for use with PVC pipe and fittings that are to be joined by PVC cement meeting the requirements of Specification D 2564.
- ASTM F 891** Specification for Coextruded Poly (Vinyl Chloride) (PVC) Plastic Pipe with a Cellular Core Non-pressure in Three Series: Schedule 40, PS Series 25, 50, 100, and a Sewer and Drain Series  
SCOPE: This specification covers coextruded PVC plastic pipe with a cellular core for non-pressure use in three series: an IPS Schedule 40 Series; a PS Series with an iron pipe size outside diameter with varying wall thickness as required for pipe stiffness of 25, 50 and 100; and a Sewer and Drain Series.
- ASTM F 1488** Specification for Coextruded Composite Pipe produced by a coextrusion die system in which the concentric layers are formed and combined before exiting the die.  
SCOPE: This specification covers ABS/PVC composite, cellular core (foam core) pipe and ABS DWV fittings used in sanitary drain, waste, and vent (DWV) and sewer applications. This system is intended for use in non-pressure applications where the operating temperature will not exceed 140°F.
- ASTM F 1668** Standard Guide for Construction Procedures for Buried Plastic Pipe  
SCOPE: This guide describes installation techniques and considerations for open-cut construction of buried pipe.
- ASTM F 1866** Specification for Poly (Vinyl Chloride) (PVC) Plastic Schedule 40 Drainage and DWV Fabricated Fittings  
SCOPE: This specification covers requirements and test methods for fabricated poly (vinyl chloride) (PVC) plastic Schedule 40 drainage and DWV fittings to be used with piping manufactured in accordance with specification D 2665, D 1785 or F 891. These fabricated fittings are manufactured from pipe or from a combination of pipe and injection-molded parts.

## Reference Standards Plastics

### NSF INTERNATIONAL

#### NSF / ANSI TITLE

---

- NSF 14**                      Plastics Piping System Components and Related Materials  
SCOPE: This standard establishes minimum physical, performance, health effects, quality assurance, marking and record-keeping requirements for plastic piping components and related materials. The established physical, performance and health effects requirements apply to materials (resin or blended compounds) and ingredients used to manufacture plastic piping system components.
- NSF 61**                      Drinking Water System Components - Health Effects  
SCOPE: This standard covers specific materials or products that come into contact with drinking water, drinking water treatment chemicals or both. The focus of the standard is evaluation of contaminants or impurities imparted indirectly to drinking water.

### UNDERWRITERS LABORATORIES

#### UL TITLE

---

- UL 94**                      Flammability Testing  
SCOPE: This test indicates that the material was tested in a vertical position and self-extinguished within a specified time after the ignition source was removed.

## Temperature Conversion

Degrees Fahrenheit	Degrees Centigrade	Degrees Fahrenheit	Degrees Centigrade
-10	-23.3	90	32.2
-5	-20.6	95	35.0
0	-17.8	100	37.8
5	-15.0	110	43.3
10	-12.2	120	48.9
15	-9.4	130	54.4
20	-6.7	140	60.0
25	-3.9	150	65.6
32	0	160	71.1
35	1.7	170	76.7
40	4.4	180	82.2
45	7.2	190	87.8
50	10.0	200	93.3
55	12.8	212	100.0
60	15.6	220	104.4
65	18.3	230	110.0
70	21.1	240	115.6
75	23.9	250	121.1
80	26.7	260	126.7
85	29.4		

For temperatures not shown, the following formulas apply:  
 $^{\circ}\text{F to }^{\circ}\text{C} = (^{\circ}\text{F} - 32) / 1.8$        $^{\circ}\text{C to }^{\circ}\text{F} = (^{\circ}\text{C} \times 1.8) + 32$

## Metric Conversion

Pipe Size (mm)	Pipe Size (in.)	Pipe Size (mm)	Pipe Size (in.)
6mm	¼ in.	90mm	3½ in.
7mm	⅜ in.	100mm	4 in.
8mm	¼ in.	125mm	5 in.
10mm	⅜ in.	150mm	6 in.
15mm	½ in.	200mm	8 in.
18mm	⅝ in.	250mm	10 in.
20mm	¾ in.	300mm	12 in.
25mm	1 in.	350mm	14 in.
32mm	1¼ in.	400mm	16 in.
40mm	1½ in.	450mm	18 in.
50mm	2 in.	500mm	20 in.
65mm	2½ in.	600mm	24 in.
80mm	3 in.		

# HELPFUL REFERENCES

## The Conversion of Fractions to Decimals

Fraction	Decimal	Fraction	Decimal
$\frac{1}{64}$	0.015625	$\frac{33}{64}$	0.515625
$\frac{1}{32}$	0.031250	$\frac{17}{32}$	0.53125
$\frac{3}{64}$	0.046875	$\frac{35}{64}$	0.546875
$\frac{1}{16}$	0.062500	$\frac{9}{16}$	0.5625
$\frac{5}{64}$	0.078125	$\frac{37}{64}$	0.578125
$\frac{3}{32}$	0.0937500	$\frac{19}{32}$	0.59375
$\frac{7}{64}$	0.109375	$\frac{38}{64}$	0.609375
$\frac{1}{8}$	0.125000	$\frac{5}{8}$	0.625
$\frac{9}{64}$	0.140625	$\frac{41}{64}$	0.640625
$\frac{5}{32}$	0.156250	$\frac{21}{32}$	0.65625
$\frac{11}{64}$	0.171900	$\frac{43}{64}$	0.67187
$\frac{3}{16}$	0.187500	$\frac{11}{16}$	0.6875
$\frac{13}{64}$	0.203100	$\frac{45}{64}$	0.70312
$\frac{7}{32}$	0.218800	$\frac{23}{32}$	0.71875
$\frac{15}{64}$	0.234375	$\frac{47}{64}$	0.734375
$\frac{1}{4}$	0.250000	$\frac{3}{4}$	0.75
$\frac{17}{64}$	0.265625	$\frac{49}{64}$	0.765625
$\frac{9}{32}$	0.281250	$\frac{25}{32}$	0.78125
$\frac{19}{64}$	0.296875	$\frac{51}{64}$	0.79875
$\frac{5}{16}$	0.312500	$\frac{13}{16}$	0.8125
$\frac{21}{64}$	0.328125	$\frac{53}{64}$	0.82125
$\frac{11}{32}$	0.343750	$\frac{27}{32}$	0.84375
$\frac{23}{64}$	0.359375	$\frac{55}{64}$	0.859375
$\frac{3}{8}$	0.375000	$\frac{7}{8}$	0.875
$\frac{25}{64}$	0.398625	$\frac{57}{64}$	0.890625
$\frac{13}{32}$	0.406250	$\frac{29}{32}$	0.90625
$\frac{27}{64}$	0.421875	$\frac{59}{64}$	0.921875
$\frac{7}{16}$	0.437500	$\frac{15}{16}$	0.9375
$\frac{29}{64}$	0.453125	$\frac{61}{64}$	0.953125
$\frac{15}{32}$	0.468750	$\frac{31}{32}$	0.96875
$\frac{31}{64}$	0.484375	$\frac{63}{64}$	0.984375
$\frac{1}{2}$	0.500000	1"	1





# LIMITED WARRANTY

Charlotte Pipe and Foundry Company® (Charlotte Pipe®) Products are warranted to be free from manufacturing defects and to conform to currently applicable ASTM standards for a period of five (5) years from date of delivery. Buyer's remedy for breach of this warranty is limited to replacement of, or credit for, the defective product. This warranty excludes any expense for removal or reinstallation of any defective product and any other incidental, consequential, or punitive damages. **This limited warranty is the only warranty made by seller and is expressly in lieu of all other warranties, express and implied, including any warranties of merchantability and fitness for a particular purpose.** No statement, conduct or description by Charlotte Pipe or its representative, in addition to or beyond this Limited Warranty, shall constitute a warranty. This Limited Warranty may only be modified in writing signed by an officer of Charlotte Pipe.

This Limited Warranty will not apply if:

- 1) The Products are used for purposes other than their intended purpose as defined by local plumbing and building codes, and the applicable ASTM standard.
- 2) The Products are not installed in good and workmanlike manner consistent with normal industry standards; installed in compliance with the latest instructions published by Charlotte Pipe and good plumbing practices; and installed in conformance with all applicable plumbing, fire and building code requirements.
- 3) This limited warranty does not apply when the products of Charlotte Pipe are used with the products of other manufacturers that do not meet the applicable ASTM or CISPI standards or that are not marked in a manner to indicate the entity that manufactured them.
- 4) In hubless cast iron installations, this warranty will not apply if products are joined with unshielded hubless couplings. Charlotte Pipe requires that its hubless cast iron pipe and fittings be joined only with shielded hubless couplings manufactured in accordance with CISPI 310, ASTM C 1277 and certified by NSF® International or with Heavy Duty Couplings meeting ASTM C 1540.
- 5) The Products fail due to defects or deficiencies in design, engineering, or installation of the piping system of which they are a part.
- 6) The Products have been the subject of modification; misuse; misapplication; improper maintenance or repair; damage caused by the fault or negligence of anyone other than Charlotte Pipe; or any other act or event beyond the control of Charlotte Pipe.
- 7) The Products fail due to the freezing of water in the Products.
- 8) The Products fail due to contact with chemical agents, fire stopping materials, thread sealant, plasticized vinyl products, or other aggressive chemical agents that are not compatible.
- 9) Pipe outlets, sound attenuation systems or other devices are permanently attached to the surface of Charlotte® PVC, ABS or CPVC products with solvent cement or adhesive glue.

Charlotte Pipe products are manufactured to the applicable ASTM or CISPI standard. Charlotte Pipe and Foundry **cannot** accept responsibility for the performance, dimensional accuracy, or compatibility of pipe, fittings, gaskets, or couplings not manufactured or sold by Charlotte Pipe and Foundry.

This Limited Warranty will not apply unless written notice of a claim is mailed to Charlotte Pipe at the address below within 30 days of discovery of the allegedly defective product.

Any Charlotte Pipe products alleged to be defective **must** be made available to Charlotte Pipe at the following address for verification, inspection and determination of cause:

Charlotte Pipe and Foundry Company  
Attention: Technical Services  
2109 Randolph Road  
Charlotte, North Carolina 28207

**Purchaser must obtain a return materials authorization** and instructions for return shipment to Charlotte Pipe of any product claimed defective or shipped in error.

Any Charlotte Pipe product **proved** to be defective in manufacture will be replaced F.O.B. point of original delivery, or credit will be issued, at the discretion of Charlotte Pipe.

4/20/21

Charlotte, Charlotte Pipe and "You can't beat the system" are registered trademarks of Charlotte Pipe and Foundry Company.

# FLOWGUARD GOLD® CPVC CTS LIMITED WARRANTY

**CHARLOTTE**  
PIPE AND FOUNDRY COMPANY®

Charlotte Pipe and Foundry Company (Charlotte Pipe®) warrants to the original owner of the structure in which its FlowGuard Gold CTS CPVC Pipe and Fittings (the "Products") have been installed, that the Products will be free from manufacturing defects and conform to currently applicable ASTM standards under normal use and service for a period of ten (10) years. Buyer's remedy for breach of this warranty is limited to replacement of, or credit for, the defective product. This warranty excludes any expense for removal or reinstallation of any defective product and any other incidental, consequential, or punitive damages. **This limited warranty is the only warranty made by seller and is expressly in lieu of all other warranties, express and implied, including any warranties of merchantability and fitness for a particular purpose.** No statement, conduct or description by Charlotte Pipe or its representative, in addition to or beyond this Limited Warranty, shall constitute a warranty. This Limited Warranty may only be modified in writing signed by an officer of Charlotte Pipe.

This Limited Warranty will not apply if:

- 1) The Products are used for purposes other than the transmission of domestic water.
- 2) The Products are not installed in good and workmanlike manner consistent with normal industry standards; installed in compliance with the latest instructions published by Charlotte Pipe and good plumbing practices; and installed in conformance with all applicable plumbing, fire and building code requirements.
- 3) This limited warranty does not apply when the products of Charlotte Pipe are used with the products of other manufacturers that do not meet the ASTM standard or that are not marked in a manner to indicate the entity that manufactured them.
- 4) The Products fail due to defects or deficiencies in design, engineering, or installation of the water distribution system of which they are a part.
- 5) The Products have been the subject of modification; misuse; misapplication; improper maintenance or repair; damage caused by the fault or negligence of anyone other than Charlotte Pipe; or any other act or event beyond the control of Charlotte Pipe.
- 6) The Products fail due to the freezing of water in the Products.
- 7) The Products fail due to contact with chemical agents, fire stopping materials, thread sealant, plasticized vinyl products, or other aggressive chemical agents not compatible with CPVC compounds.

Charlotte Pipe products are manufactured to the applicable ASTM standard. Charlotte Pipe and Foundry **cannot** accept responsibility for the performance, dimensional accuracy, or compatibility of pipe, fittings, gaskets, or couplings not manufactured or sold by Charlotte Pipe and Foundry.

This Limited Warranty will not apply unless written notice of a claim is mailed to Charlotte Pipe at the address below within 30 days of discovery of the allegedly defective product.

Any Charlotte Pipe products alleged to be defective **must** be made available to Charlotte Pipe at the following address for verification, inspection and determination of cause:

Charlotte Pipe and Foundry Company  
Attention: Technical Services  
2109 Randolph Road  
Charlotte, North Carolina 28207

**Purchaser must obtain a return materials authorization** and instructions for return shipment to Charlotte Pipe of any product claimed defective or shipped in error.

Any Charlotte Pipe product **proved** to be defective in manufacture will be replaced F.O.B. point of original delivery, or credit will be issued, at the discretion of Charlotte Pipe.

4/20/21

Charlotte, Charlotte Pipe and "You can't beat the system" are registered trademarks of Charlotte Pipe and Foundry Company.  
FlowGuard Gold is a registered trademark of Lubrizol Corp.

# CHARLOTTE

**PIPE AND FOUNDRY COMPANY®**

PO BOX 35430

CHARLOTTE

NORTH CAROLINA 28235

PHONE (704) 348-6450

(800) 438-6091

FAX (800) 553-1605

[WWW.CHARLOTTEPIPE.COM](http://WWW.CHARLOTTEPIPE.COM)

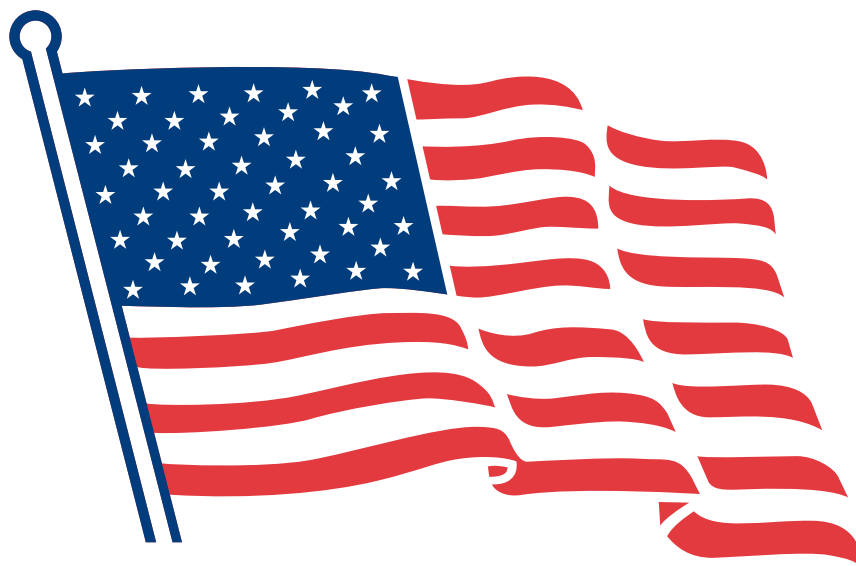

All products manufactured by  
Charlotte Pipe and Foundry Company  
are proudly made in the U.S.A.

