



# Zurn PEX<sup>®</sup>

## Residential Plumbing Installation Guide



## TABLE OF CONTENTS

SECTION	PAGE NO.	SECTION	PAGE NO.
<b>Introduction</b> .....	<b>2</b>	Stainless Steel Clamp Ring System .....	17
<b>Installation Methods</b> .....	<b>2</b>	Listings .....	17
Conventional Method – Trunk and Branch .....	3	Making The Connection – Stainless Steel Clamp Ring .....	17
Home-Run Method – Parallel .....	3	Recommendations for Making Sweat Connections with Zurn PEX XL (Lead-Free) Fittings .....	17
Multi-Port Tee Method .....	3	<b>Water Service Installation</b> .....	<b>18</b>
<b>PEX Tubing Manufacturing Methods</b> .....	<b>4</b>	Before You Start .....	18
The Silane (PEX-b) Method .....	4	Inspection .....	18
Benefits of Zurn PEX Tubing .....	4	Preparation .....	18
Additional Applications .....	4	Installation .....	18
Zurn PEX Tubing Sizes and Dimensions .....	4	<b>Top Out Installation</b> .....	<b>21</b>
Print String Marking .....	5	Uncoiling Zurn PEX Tubing .....	21
Zurn PEX Tubing Installation Precautions .....	5	Supporting Zurn PEX Distribution Lines .....	21
<b>Fitting Systems</b> .....	<b>6</b>	Connecting Zurn PEX to Endpoints .....	23
Zurn PEX CR Fitting System .....	6	Water Line Disinfection .....	25
Listings .....	6	Pressure Testing .....	25
Zurn PEX CR Installation Precautions .....	6	Zurn PEX Installation Precautions .....	25
Zurn PEX XL Brass Fitting System .....	6	<b>Connecting Zurn PEX to a Water Heater</b> .....	<b>26</b>
Listings .....	6	<b>Installation with a Zurn PEX Manifold</b> .....	<b>26</b>
Zurn PEX XL Installation Precautions .....	6	Sizing the QuickPort® Manifold System .....	26
<b>Z-Bite™ Push-to-Connect Fittings</b> .....	<b>7</b>	Locating the QuickPort Manifold .....	26
Making the Connection with Z-Bite Fittings .....	7	Mounting the QuickPort Manifold .....	27
Z-Bite Features .....	7	Connecting Service Lines .....	27
Listings .....	7	Zurn PEX Distribution Lines .....	28
<b>Crimp Systems</b> .....	<b>10</b>	<b>Connecting Zurn PEX Tubing to the QuickPort Manifold</b> .....	<b>29</b>
QuickClamp® System .....	10	QuickClamp Connections .....	29
Listings .....	10	Zurn PEX CR Valve Connections .....	29
Making the Connection with the Medium QuickClamp Tool .....	10	Quicktite Connections .....	29
Adjusting The Medium QuickClamp Crimp Tool .....	11	Unused Port Connections .....	30
Making the Connection with the Small QuickClamp Crimp Tool .....	12	Bundling Zurn PEX Distribution Lines .....	30
Adjusting The Small QuickClamp Tool .....	12	Completing the Installation .....	30
Copper Crimp Ring System .....	13	<b>NSF Standards, Descriptions, and Markings</b> .....	<b>31</b>
Listings .....	13	<b>ASTM Standards and Descriptions</b> .....	<b>31</b>
Making the Connection with the Large Crimp Tool .....	13	<b>Standards, Listings, and Codes</b> .....	<b>34</b>
<b>Using the Zurn Go/No-Go Gauge</b> .....	<b>15</b>	<b>Certification Test</b> .....	<b>36</b>
Adjusting the Large Crimp Tool .....	15	<b>Professional Installation Limited Warranty</b> .....	<b>37</b>
Adjusting the Medium Crimp Tool .....	16		

**Notice:** This manual describes general installation recommendations for Zurn PEX hot and cold potable water distribution systems. It is the sole responsibility of the installation professional to ensure that this product meets local code requirements. Failure to observe the installation instructions may result in substandard performance of the system. Zurn expressly disclaims any responsibility or liability for substandard performance resulting from failure to comply with installation instructions.

Zurn PEX fittings are identified by the letters “Q” and “PEX” or “Z” and “PEX” stamped onto the body of the fitting. Zurn PEX XL brass fittings are also marked with a “G.” The PEX fittings also have three ribs on the insert portion of the fitting.

Zurn PEX copper crimp rings are identified by the letters “Q” and “PEX” or “Z” and “PEX” stamped on the outside of the ring. Zurn PEX crimp rings are colored black for easy identification.

Zurn PEX QuickClamp® fittings are identified by the name “QuickClamp” stamped on the outside of the clamp.

## The Zurn PEX Plumbing System

PEX is an innovative product that was developed in the 1960s to address the problems associated with rigid plumbing systems that use materials like copper, steel, and CPVC. Zurn PEX Plumbing Systems, at the forefront of technological advancement, pioneered the first flexible residential plumbing system in the early 1970s. Since that time, Zurn PEX has continually initiated further advancements in the plumbing industry.

The Zurn PEX Plumbing System consists of Zurn PEX tubing, Zurn PEX CR, and Zurn PEX XL brass fittings, the patent-pending QickClamp®, the copper crimp ring and stainless steel clamp systems, and the QickPort® Manifold, as well as additional Zurn PEX components used to assemble these systems.

Zurn Pex, Inc. manufactures, assembles, packages, and supplies our quality PEX systems in our state-of-the-art manufacturing facility located in North America. From our tubing to our patent-pending crimp system, Zurn Pex remains a leader in the flexible plumbing systems industry.

## Applications

In addition to hot and cold water distribution, some applications for Zurn Pex Systems include:

- Radiant Heating Systems
- Snow and Ice Melt Systems
- Turf Conditioning Systems
- Municipal Water Service
- Reverse Osmosis Systems
- Deionized Water Systems

## Advantages of a Zurn PEX System

- Environmentally Sound
- Easy and Safe to Install
- Reliable
- Cost Effective

## Installation Methods

When installing a PEX plumbing system, you must first choose your method of installation. This section outlines the three most common types of PEX plumbing installation methods.

In order to choose the method that best suits your jobsite requirements consider the factors relevant to your priorities. See Table 2.1.

**Table 2.1** System Performance Based on Factor Dependency

Factor	Optimal Performance	Elevated Performance	Typical Performance
Minimize Pipe Used	Conventional	Multi-Port Tee	Home Run
Minimize Fittings and Joints	Home Run	Multi-Port Tee	Conventional
Sequential Flow Hot Water Delivery Time	Conventional/ Multi-Port Tee		Home Run
Minimize Hot Water Wait Time	Home Run	Multi-Port Tee	Conventional
Single Fixture Pressure	Conventional	Home Run/ Multi-Port Tee	
Pressure Stability with Use of Multiple Fixtures	Home Run	Multi-Port Tee	Conventional
Centralize Shut-off Valving	Home Run	Multi-Port Tee	Conventional
Joint Accessibility During Installation	Home Run	Multi-Port Tee	Conventional

## Installation Methods, continued

### Conventional Method – Trunk and Branch

The Conventional or Trunk and Branch Method is the same method used in rigid plumbing systems. Running PEX tubing in the Conventional Method requires the installation of a main trunk line which branches to specific outlets. This method does reduce the total linear feet of tubing used; however, it does require more fittings, which can increase cost and installation time.

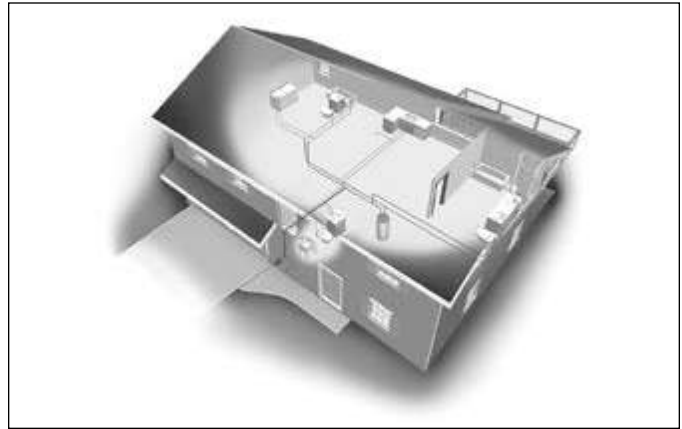

Figure 2.1 Conventional Method for Colonial Home

### Home-Run Method – Parallel

The Home Run or Parallel Method distributes water to each fixture from a centrally located manifold. The manifold is typically located close to the hot water source in order to provide fast and efficient hot water delivery. The Home Run Method provides a dedicated line from the manifold to the fixture which reduces the need for fittings behind the wall.

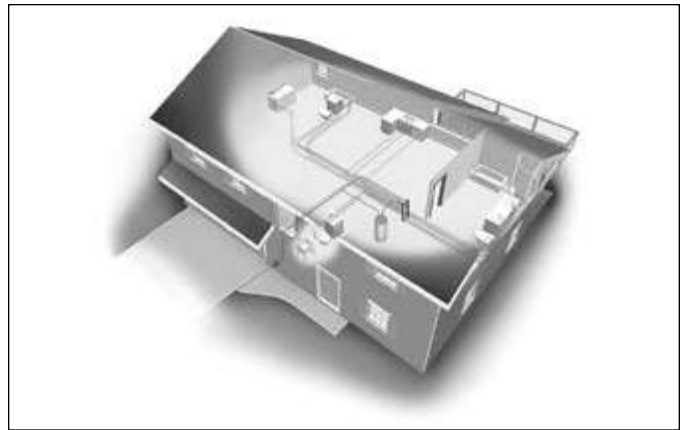

Figure 2.2 Home Run Method for Colonial Home

### Multi-Port Tee Method

The Multi-Port Tee Method combines the benefits of the Conventional and Home Run Methods. The Multi-Port Tee Method runs individual branch lines from smaller manifold located near groups of fixtures. This effectively reduces the length of total tubing used on the job, while minimizing the number of fittings required for the Conventional Method of Installation.

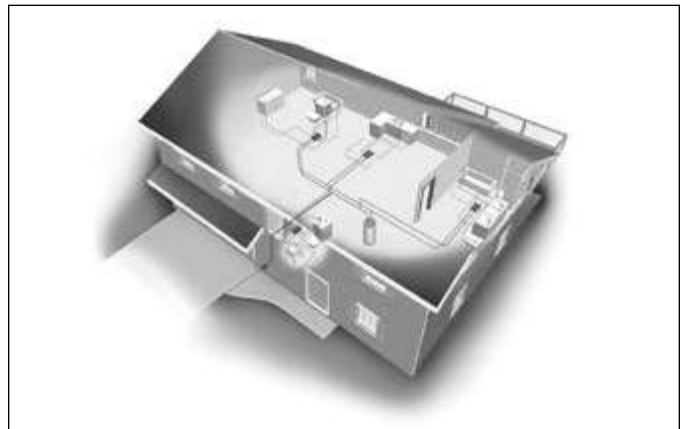

Figure 2.3 Multi-Port Tee Method

## PEX Tubing Manufacturing Methods

There are three industrial methods for manufacturing PEX tubing; peroxide (Engel), silane, and radiation (E-Beam), also referred to as PEX-a, PEX-b, and PEX-c, respectively.

PEX-a, b, and c designations are not recognized by ASTM standards because they are often misinterpreted as a grading system for PEX. In truth, the terms were used only as a means of identifying the method of production within the European marketplace.

### The Silane (PEX-b) Method

Zurn Pex, Inc. chooses the Silane (PEX-b) method to manufacture its tubing. While high degrees of cross-linking can be achieved using this method, it is unnecessary because the density of the base resin for Zurn PEX is higher compared to PEX-a and PEX-c methods. The denser material produces structurally superior tubing at a lower level of cross-linking which allows Zurn PEX to offer tubing with the highest burst pressure ratings and tensile strength in the industry.

Silane manufactured Zurn PEX has significantly higher levels of antioxidants compared to other methods of cross-linking. PEX-b processes can tolerate additives which allow Zurn to incorporate stabilizers in their formulations that improve the thermal, chlorine, and UV resistance values of the tubing. The Zurn PEX formulation and manufacturing process gives the customer the best combination of chlorine and UV protection to maintain chlorine resistance even after typical jobsite UV exposure. Additionally, the Silane method permits the linking of up to four molecules at any given cross-linking site, which contributes to the superior mechanical strength and dimensional stability of Zurn PEX tubing.

### Benefits of Zurn PEX Tubing

- UV Resistance
  - Maximum exposure 6 months
- Chlorine Resistance
  - PEX 5306 Designation – Generally a continuously circulating hot water plumbing loop at 140°F.
- Temperature and Pressure Ratings
  - 160 psi @ 73°F
  - 100 psi @ 180°F
  - 80 psi @ 200°F

**Note:** The inherent flexibility of Zurn PEX tubing results in decreased susceptibility to damage as a result of repeated pressure surges and less noise due to pressure surges, commonly referred to as water hammer, making water hammer arrestors unnecessary in typical PEX plumbing applications. Water hammer arrestors are advisable only when local code requires them. Zurn offers water hammer arrestors for residential and commercial applications. See Zurn.com for product details.

### Additional Applications

- **Reverse Osmosis (RO)** – Installing Zurn PEX in a reverse osmosis application is ideal because it is not susceptible to the corrosive effects of pure water. When using Zurn PEX in RO applications, Zurn PEX CR insert fittings should also be used.
- **Deionized Water (DI)** – Installing Zurn PEX in a deionized water application is ideal because it is not susceptible to the corrosive effects of pure water. When using Zurn PEX in DI applications, Zurn PEX CR insert fittings should also be used.

## Zurn PEX Tubing Sizes and Dimensions

Zurn Designation	Nom. Size (CTS)	Avg. O.D. (In.)	Avg. I.D. (In.)	Min. Wall Thickness	Fluid Capacity (Gal/Foot)	Wt. Per 100 Ft. (Lbs.)
Q1P	1/4"	.375 (3/8")	.225 (9/40")	.062	>0.001	3
Q2P	3/8"	.500 (1/2")	.350 (7/20")	.070	.005	4
Q3P	1/2"	.625 (5/8")	.475 (19/40")	.070	.009	5
Q4P	3/4"	.875 (7/8")	.671 (51/76")	.097	.018	10
Q5P	1"	1.125 (1-1/8")	.862 (25/29")	.125	.030	17
Q6P	1-1/4"	1.375 (1-3/8")	1.054 (1-2/37")	.153	.045	26
Q7P	1-1/2"	1.625 (1-5/8")	1.244 (1-10/41")	.181	.063	37
Q8P	2"	2.125 (2-1/2")	1.629 (1-22/35")	0.236	0.108	60

## Print String Marking

Zurn PEX tubing is marked in five-foot increments with the following information:

Manufacturer	Zurn PEX
Manufacturing Code	C-D3
Listing Agency/Annex G Compliance	cNSFus-pw - G
Uniform Plumbing Code	U.P. Code
Material Designation Code	PEX 5306
ASTM Tubing Standards*	ASTM F876/F877
Water Service Listing	AWWA C904
Canadian Standard	B137.5
UPC Listing	UPC - Hot/Cold Potable Water
Standard Dimension Ratio	SDR 9
Pressure/Temperature Ratings	160 psi at 73°F 100 psi at 180°F 80 psi at 200°F
Tube Size	1/2" CTS - 5/8" OD
Fitting Standards**	F1807, F1865, F1960, F2080, F2098, F2159
Production Code, Date, and Time	A - 03/08/10 - 14:11
Country of Manufacture	Made in the U.S.A.
Length Marker***	0013 Ft.
Fire Protection Listing	UL1821

\*Zurn PEX tube 2" and smaller meets the 25/50 flame spread index/smoke density index requirements specified in building codes for use in plenums when encased with an appropriately listed 1/2" thick fiberglass insulation. Un-insulated installations using special accessories may also comply, please consult with the factory for details.

\*\*Only components and systems sold by Zurn PEX are covered by the Zurn PEX warranty.

\*\*\*Only on coils.

**NOTE: Please refer to page 31 and 32 for ASTM standard descriptions.**

## Zurn PEX Tubing Installation Precautions

When working with Zurn PEX tubing we recommend following the practices listed below to maximize the life of the system.

**Note:** The Zurn PEX recommendation is intended to provide customers with knowledge for the safe handling, storage, and installation of Zurn PEX tubing. While this list is not comprehensive, an understanding of the strengths and limitations of Zurn PEX tubing will help to ensure that it maintains optimum performance characteristics throughout the life of the system.

- Zurn PEX tubing should not be exposed to or stored in direct ultraviolet light. When possible, protect the tubing with an opaque covering.
- Zurn PEX should not be exposed to direct flame. If it is necessary to braze, solder, or weld, do so prior to connecting Zurn PEX to metal pipe.
- Zurn PEX should never be used for electrical grounding. Consult the NEC for recommended grounding methods when PEX is used.

- Zurn PEX should not be installed in conditions near extreme heat.
- Painting Zurn PEX is unnecessary. Water-based latex or acrylic paints will not affect Zurn PEX tubing; however, oil-based paints or lacquers should never be applied to Zurn PEX tubing.
- Zurn PEX should only be used in operating conditions that are consistent with pressure ratings that appear on the tubing and applicable standards.
- Zurn PEX tubing should not be subjected to prolonged exposure to free chlorine concentrations greater than 4 ppm.
- Zurn PEX tubing that has been crushed or scratched should be removed from the system and replaced.
- Zurn PEX should never come into contact with any chemicals, pipe thread compounds, putty, mineral or linseed oil products.
- 5 degree F minimum installation temp

## Fitting Systems

Zurn PEX is a relatively inert material and is therefore joined by mechanical connections. Zurn's mechanical connections consist of an insert fitting and a clamp system to make the connection between the tubing and the fitting. To suit your installation needs Zurn offers two choices for insert fittings – Zurn PEX CR and Zurn PEX XL.

### Zurn PEX CR Fitting System

Zurn PEX CR fittings are molded from a blend of highly engineered polymers. The inherent qualities of the polymers make fittings highly resistant to chlorine and other chemicals present in potable water. Zurn PEX CR fittings are a superior alternative to metallic fittings in areas with localized aggressive water chemistries.

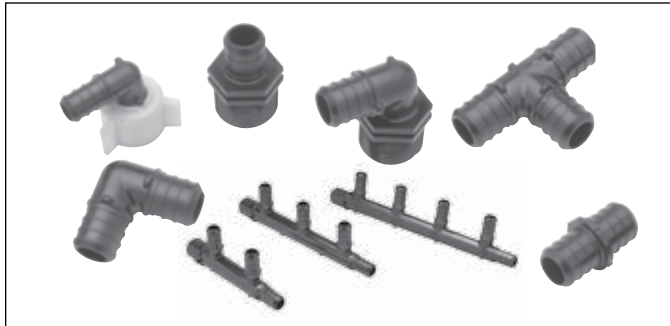

#### Listings

By 3rd Party Certifiers as meeting the following standards:

- ASTM F877
- ASTM F2159
- CAN/CSA B137.5
- NSF Standard 14
- NSF Standard 61, Including Annex G

### Zurn PEX CR Installation Precautions

When working with Zurn PEX CR fittings, we recommend following the practices listed below to maximize the life of the system. **Note:** The Zurn PEX recommendation is intended to provide customers with knowledge for the safe handling, storage, and installation of the Zurn PEX CR fittings. While this list is not comprehensive, an understanding of the strengths and limitations of the Zurn PEX CR fittings will help to ensure that they maintain optimum performance characteristics throughout the life of the system.

- Zurn PEX CR fittings should only be used in operating conditions that are consistent with temperature and pressure ratings of the tube as well as applicable standards.
- Zurn PEX CR fittings should not be painted.
- Zurn PEX CR fittings should not be exposed to direct ultraviolet light. When possible, protect fittings with an opaque covering.
- Zurn PEX CR male pipe threads must only use PTFE tape as a thread sealant.
- Zurn PEX CR fittings should not be exposed to cleaners, chemicals, solvents, sealants, or glues as they could be damaged from contact.
- Zurn PEX CR fittings should always be stored in clean, preferably lined, bins or containers.
- Zurn PEX CR Fittings must be protected from contact with spray foam insulation or sealants.

### Zurn PEX XL Brass Fitting System

With over 30 years of installations, Zurn PEX XL brass fittings are the reliable joining method for flexible piping.

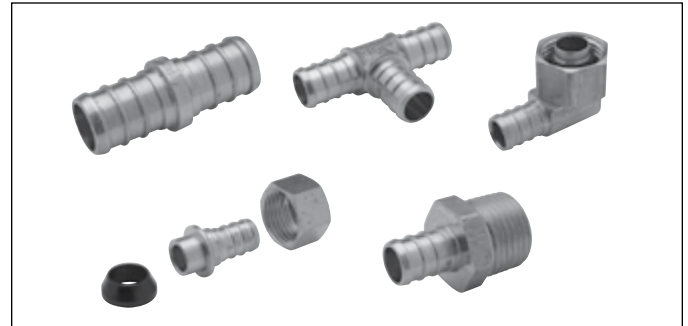

#### Listings

By 3rd Party Certifiers as meeting the following standards:

- ASTM F877
- ASTM F1807
- CAN/CSA B137.5
- NSF Standard 14
- NSF Standard 61, Including Annex G

### Zurn PEX XL Installation Precautions

When working with Zurn PEX XL fittings, we recommend following the practices listed below to maximize the life of the system. Zurn PEX XL fittings are manufactured from a dezincification resistant low lead alloy called ECO BRASS®. It is compliant with low lead legislation in the states of California and Vermont, as well as Federal Low Lead Requirements. **Note:** The Zurn PEX recommendation is intended to provide customers with knowledge for the safe handling, storage, and installation of the Zurn PEX XL fittings. While this list is not comprehensive, an understanding of the strengths and limitations of the Zurn PEX XL fittings will help to ensure that they maintain optimum performance characteristics throughout the life of the system.

- Zurn PEX XL fittings should only be used in operating conditions that are consistent with temperature and pressure ratings as well as applicable standards.
- Zurn PEX XL fittings should not be used in reverse osmosis systems.
- Zurn PEX XL fittings should not be used in areas with known localized aggressive water chemistries.

## Z-Bite™ Push-to-Connect Fittings

Zurn offers a variety of push type fittings for potable water applications, including various sizes of caps, couplings, tees, elbows, and adapters. Z-Bite fittings allows for faster installation and repairs, resulting in less down time of a building's water system.

### Z-Bite Features

- Stainless steel grip ring provides secure hold on tubing without need for soldering, crimping, or gluing
- Reliable chloramine resistant EPDM o-ring provides leak-free 360 degree seal
- Torchless sealing method provides safer installation and allows installation without draining piping
- Z-Bite universal design allows use with PEX, copper, and CPVC
- Release collar permits easy repositioning and removal aligning with retrofit or temporary applications
- The fittings comply with the requirements of the model plumbing codes for use in inaccessible locations

### Listings

- Dependable ASSE 1061 push type fittings meet plumbing code requirements for potable applications
- NSF 61 and 372 Certified lead-free fittings



**Important:** Zurn Z-Bite fittings are not intended for and must not be used in the following situations:

1. Any application for any type of fuel, either liquid or gas.
2. With any tube of multi-layer construction including barrier tubes for radiant heating. Z-Bite fittings do not seal the ends of the tube and liquids may penetrate between the layers and cause a failure.

## Making the Connection with Z-Bite Fittings



**Important:** Using this tool for anything other than its intended purpose voids the warranty.

### Installation Instructions for Z-Bite Fittings

1. Using a tube cutter, cut the end of the tubing square. For PEX and CPVC, blade type cutters are preferred as they do not flange or burr the cut ends.

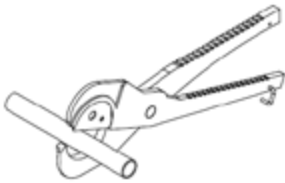

A wheel type of cutter works well for copper tube.

2. Examine the end of the tube for any scratches, gouges or lines that might prevent the o-ring from sealing on the surface of the tube.
3. Using the deburring tool, chamfer the outer edge of the cut tube end and mark the insertion depth on the tube.

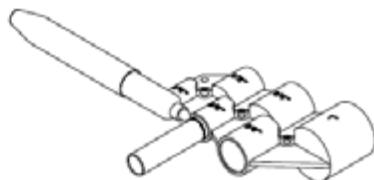
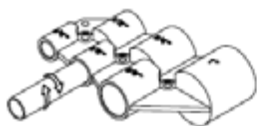

4. Examine the fitting to be sure that the tube liner is present. This liner is required when using PEX tube. If using copper or CPVC tube, the liner may be removed. See Tube Liner Removal instructions.
5. Using a slight twisting motion, insert the tube into the Z-Bite fitting until it bottoms out in the fitting socket. Some resistance can be expected as the end of the tube moves past the teeth on the retaining ring and o-ring seal. The mark for insertion depth should be visible approximately 1/8" from the end of the fitting.

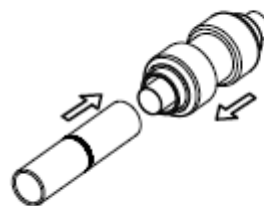

6. Ensure tube is properly installed by pulling on pipe to check for restraint.
7. Once all fittings have been installed, pressurize the system and check for leaks.
8. Please refer to the Zurn PEX Plumbing Installation Guide for additional information on the installation of PEX plumbing systems.



## Making the Connection with Z-Bite Fittings, continued

### Z-Bite Fitting Removal

1. Turn off the system water supply and relieve the pressure by opening faucets or valves to allow as much water to drain from the system as possible. The piping may still contain water that can drain out when the fitting is removed. Be prepared to contain or absorb the water to prevent damage to flooring or other surfaces

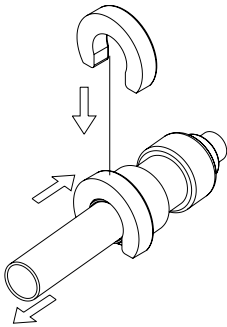

2. Place the appropriate sized Z-Bite removal clip on the tube with the grooved side facing the fitting.
3. Slide the removal clip up to the end of the fitting.
4. With one hand, hold the fitting and press the removal clip against the end of the fitting. This action spreads the teeth on the stainless steel retaining ring.
5. With the other hand, pull the tube out of the fitting while keeping the teeth of the retaining ring spread.
6. Before reuse of the fitting, check the following items:
  - a. If using PEX tube, be sure the liner is in the fitting. If not, retrieve it from the end of the tube or replace it.
  - b. Inspect the tube end to be sure it was not damaged, gouged or scratched as it was removed from the fitting. If necessary, trim the tube end so that a smooth sealing surface is available.

### Tube Liner Removal from a Z-Bite Fitting

Z-Bite fittings are supplied with the tube liner installed in the fitting. Use of this liner is mandatory when using PEX tube in a Z-Bite fitting. This liner may be removed if the fitting is being used with CPVC or copper tubing.

1. Needle nose pliers are needed to remove the liner.
2. Using the pliers, gently wiggle the tube liner and pull it past the o-ring seal.
3. Using the appropriate size removal clip, press the grooved side of the clip against the release ring on the end of the fitting to expand the teeth of the retaining ring.
4. While keeping the teeth expanded, pull the liner out of the fitting with the pliers.

### Slip Coupling Installation

A Slip Coupling is a special fitting used when it is not possible to move the ends of the tube far enough apart to install a regular coupling. The slip coupling can be installed by deflecting the tube instead of moving the ends apart.

1. First, cut the ends of the tube to create a gap between the ends of the tube measuring approximately 1/4" larger than the distance from the indicating ring on the body of the fitting to the short end of the fitting. This gap should not be larger than 2".

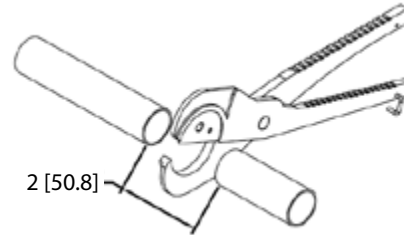

2. Chamfer and deburr the ends of both tubes and mark the insertion depth on both tubes.

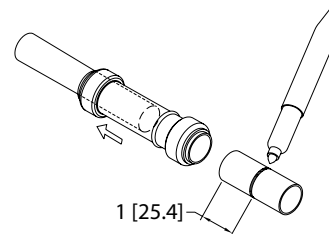

3. Deflect one of the tubes and slide the long end of the slip coupling into place until it hits the tube stop.

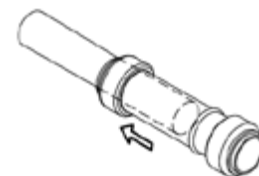

4. Line the tubes up.
5. Place the appropriate sized Z-Bite removal clip on the tube with the grooved side toward the long end of the fitting.
6. Press the removal clip against the long end of the fitting to spread the teeth on the stainless steel retaining ring and slide the coupling so the short end is installed on the other tube to the proper insertion depth.

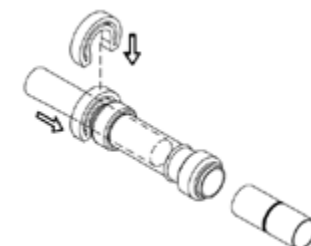

## Making the Connection with Z-Bite Fittings, continued

7. Release and remove the removal clip.
8. Check to see that the long side of the coupling still has sufficient engagement with the tube. The depth mark will either be non-visible because it is inside the fitting or it will be within 1/4" of the end of the fitting if it is visible.

## Installing the Polybutylene (PB) Transition Coupling

The Polybutylene Transition Coupling is a fitting designed to allow transition from polybutylene tube in an existing installation to PEX, CPVC or copper. Like PEX, a Z-Bite connection for polybutylene tube requires a tube liner. The portion of the liner that fits inside the tube for polybutylene will be slightly larger than the liner for the same size PEX tube. Use of a PEX liner in the polybutylene tube may cause a failure of the connection and subsequent water damage.

1. The end of the coupling containing gray polymer insert is the end to be used with the polybutylene tube.



2. Using a blade-type tube cutter, cut the end of the polybutylene tube square.
3. Examine the end of the tube for any scratches, gouges, or lines that might prevent the o-ring from sealing on the surface of the tube.
4. Using the deburring tool, chamfer the outer edge of the cut tube end and mark the insertion depth on the tube.



5. Insert the polybutylene tube into the polybutylene end of the Z-Bite fitting until it bottoms out in the fitting socket. Some resistance can be expected as the end of the tube moves past the teeth on the retaining ring and o-ring seal. The mark for insertion depth should be visible approximately 1/8" from the end of the fitting.



- 6) Follow the earlier instructions for making Z-Bite connections with PEX, CPVC or copper on the other end of the transition coupling.

## Warning and Limitations

Zurn Z-Bite fittings are not intended for and must not be used in the following situations:

1. Any application for any type of fuel, either liquid or gas.
2. With any tube of multi-layer construction including barrier tubes for radiant heating. Z-Bite fittings do not seal the ends of the tube and liquids may penetrate between the layers and cause a failure.

## Crimp Systems

Zurn offers three different clamp fitting systems: the QickClamp, the Copper Crimp Ring, and the Stainless Steel Clamp Ring system. To choose the clamp system most appropriate for your installation, consider factors relative to your jobsite priorities.

### QickClamp® System

- Patented technology
- One tool system
- Available in 3/8", 1/2", 3/4", and 1" sizes
- Go Gauge
- 25-year system warranty



### Listings

By NSF International as meeting the following standards:

- ASTM F877
- CAN/CSA B137.5
- NSF Standard 14

**Important:** The QickClamp cannot be used with Zurn PEX transitional fittings which are used to transition from polybutylene to PEX.

## Making The Connection with the Medium QickClamp Tool



**Important:** Using this tool for anything other than its intended purpose voids the warranty.

- 1) Measure and cut the tube. Be sure you have a square, burr-free cut. An uneven or jagged cut may cause an improper connection.

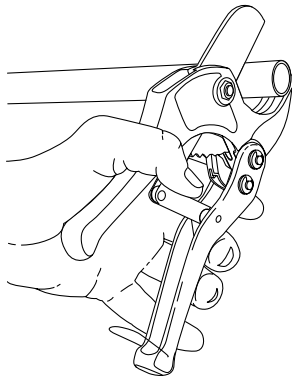

- 3) Push fitting into the tubing until the fitting shoulder touches the locating fingers on the QickClamp.

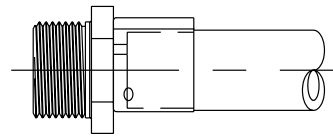

- 2) Push tubing into the QickClamp until the tubing stops at locating fingers. **Do not force the tubing to bottom out in the QickClamp.** Some tubing should be visible in the sight hole. **Be sure that the tab inside the QickClamp stays on the outside of the tubing.**

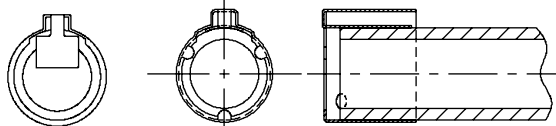

**Incorrect Assembly**

**Correct Assembly**

- 4) Open the QickClamp Medium Crimp Tool\* and pull the middle handle down. Hold the tool in one hand with your thumb over the middle handle and your fingers around the bottom handle. Place the jaws completely over the QickClamp pinch ear.

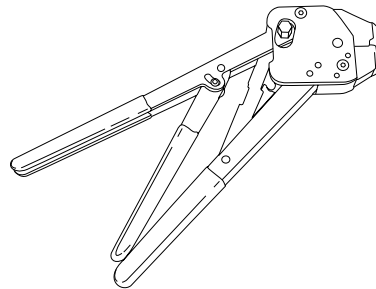

**Important:** Be sure the tool jaws cover the entire ear of the QickClamp before crimping; failure to do so will result in an improper crimp and may void the warranty. QickClamp rings must not come in contact with solder flux.

## Making the Connection with the Medium QickClamp Tool, continued

- 5) With the tool at a 90° angle to the tube, close the middle handle until it contacts the bottom handle. The ratchet will lock the handles in place. Complete the crimp by removing your thumb from the middle and squeezing the upper and lower handles together. The ratchet will allow the handle to open once the crimp is completed.

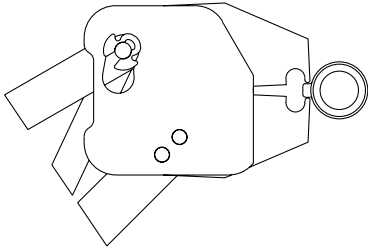

- 6) Open the QickClamp Medium Crimp Tool and remove it from the QickClamp. If the entire ear didn't crimp, **do not recrimp**. The crimp ring must be cut out and replaced.

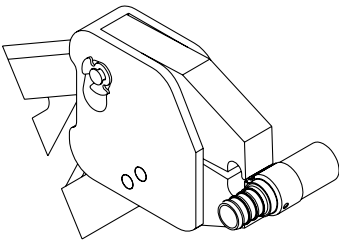

- 7) Check a completed connection with the appropriate sized section of the QickClamp Go gauge. Using the appropriate slot on the gauge for the fitting size, slide the gauge onto the crimped pinch ear. If the QickClamp pinch ear does not go into the Go gauge, the fitting should be cut out, the tool adjusted, and the fitting replaced.

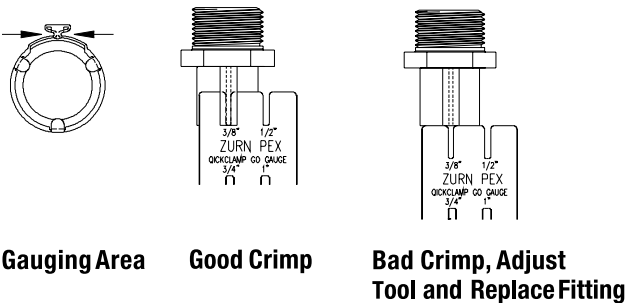

## Adjusting The Medium QickClamp Crimp Tool

The Zurn Medium QickClamp Crimp Tool is factory set to provide proper crimps. This should be checked before use by making a test crimp connection and checking it with the QickClamp Go Gauge. As long as the finished crimp connection gauges properly, there is no need to adjust the tool. **We recommend checking finished crimp connections frequently with the Zurn QickClamp Go Gauge. As more crimp connections are made, the QickClamp Tool will require adjustment. This can be detected by the crimp diameter increasing and the completed crimp does not gauge properly.**

- 1) With the tool in the open position, remove the E-clip using a screwdriver.

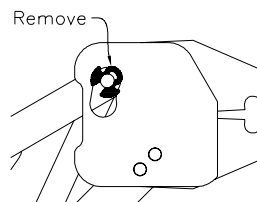

- 2) Slide the Adjustment Pin back about 1/4". **Warning: The Adjustment Pin must not be pulled or pushed completely out.** Rotate the Adjustment Pin until the line on the tool head points to the next higher number on the pin. For example, to tighten the crimp when tool is set to zero (0), adjust the pin to the one (1) position. There are five total adjustments.

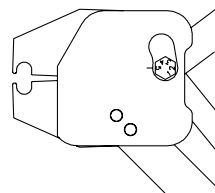

- 3) Push Adjustment Pin back in and reinstall the E-clip.

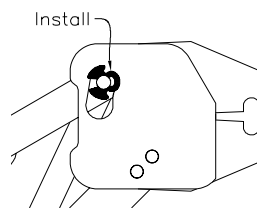

- 4) Apply light oil to the tool pivot points each time the tool is adjusted. Failure to lubricate the tool will shorten the tool's life.

## Making the Connection with the Small QickClamp Crimp Tool

The Zurn Small QickClamp crimp tool is factory set to provide proper crimps. This should be checked before use by making a **test crimp** connection and checking it with the QickClamp Go Gauge. As long as the finished crimp connection gauges properly, there is no need to adjust the tool. **We recommend checking finished crimp connections frequently with the Zurn QickClamp Go Gauge.**

### Cutting Zurn PEX Tubing

- 1) Using a blade type cutter, cut tubing to desired length.

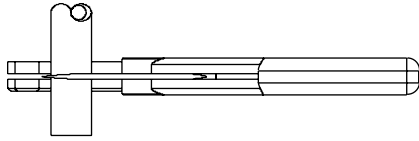

### Install QickClamp

- 2) Push tubing into the QickClamp until the tubing stops and is visible in the sight hole. **Be sure that the tab inside the QickClamp stays on the outside of the tubing.**

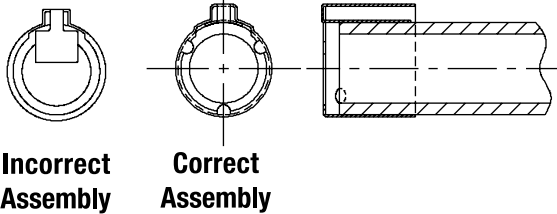

Incorrect Assembly

Correct Assembly

### Install Fitting

- 3) Push fitting into the tubing until the fitting shoulder touches the QickClamp.

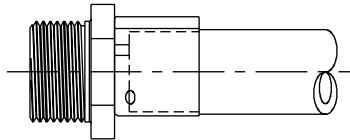

### Crimp QickClamp

- 4) Open the QCRTQCRM tool by turning the Release Knob counterclockwise (Figure 1). Place the jaws completely over the QickClamp pinch ear. With the tool at a 90° angle to the tube (Figure 2), close the tool by squeezing the handles together repeatedly until the LED light comes on. This may take 6-8 squeezes (Figure 3). **Important! Be sure the tool jaws cover the entire ear of the QickClamp before crimping. Failure to do so will result in an improper crimp and may avoid the warranty.**

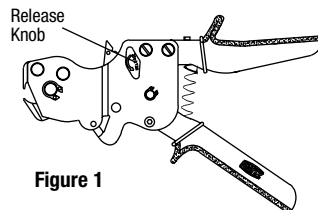

Figure 1

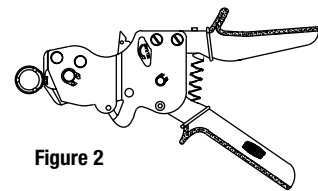

Figure 2

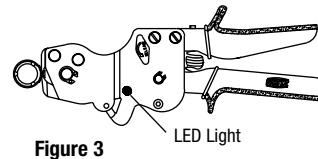
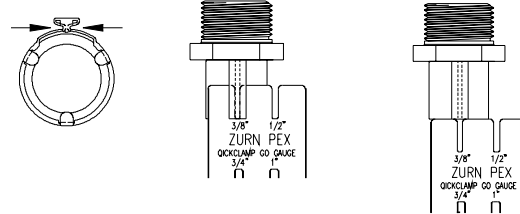

Figure 3

5. It is very important to complete the crimping process before releasing the tool. Open the QCRTQCRM tool by turning the Release Knob counterclockwise. Visually verify that a secure connection has been made. If the entire ear did not crimp, **DO NOT** recrimp. The QickClamp must be cut out and replaced.

### Using The QickClamp Go Gauge

Check a completed connection with the appropriate section of the QickClamp Go Gauge. Slide the appropriate slot of the gauge onto the crimped pinch ear. If the QickClamp pinch ear does not fit in the Go Gauge slot, the fitting should be cut out, the tool adjusted, and the fitting replaced.



Gauging Area

Good Crimp

Bad Crimp, Adjust Tool and Replace Fitting

### Adjusting The Small QickClamp Tool

- 1) Close the jaws about half way with 3 or 4 squeezes of the handles.
- 2) Holding the tool with the jaws pointed toward you and the moving handle on top, find the Adjusting Screw on the ratchet arm. It is the lower screw that is visible through a small hole.
- 3) Use the Allen wrench supplied with the tool to raise or lower the screw.
- 4) Raising the screw by turning counterclockwise will cause the jaw gap to increase at the point the LED light comes on. It will be rare that this adjustment will be required.
- 5) Lowering the screw by turning clockwise will cause the jaw gap to decrease at the point the LED light comes on. Do not turn the screw more than 1/4 turn at a time before making a test crimp and checking with the QickClamp Go Gauge. Do not adjust more than required to give finished clamps that gauge properly.

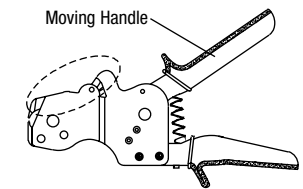
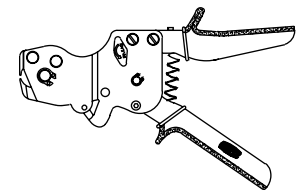

Moving Handle

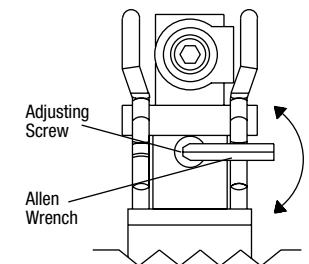

Detail Side View of Adjusting Screw Area

## Copper Crimp Ring System

- Proven system for over 30 years
- Copper Crimp Ring available in 3/8" - 2"
- QuickCap® Copper Crimp Ring with Positioning Cap, QCR\_XPC, is available in 1/2" - 2"
- Go/No-Go Gauge
- 25-year system warranty



## Standards

By NSF International as meeting the following standards:

- ASTM F877
- ASTM F1807
- CAN/CSA B137.5
- NSF Standard 14

## Making the Connection with the Large Crimp Tool

**Note:** Use the crimp tool only to install PEX tube/fitting systems meeting ASTM F1807 for brass or copper insert fittings and F2159 for plastic insert fittings.

 **Important:** Always refer to the tube manufacturers' product assembly instructions when using the crimp tool.

1. Measure and cut the tube. Be sure you have a square burr-free cut. An uneven or jagged cut may cause an improper connection.

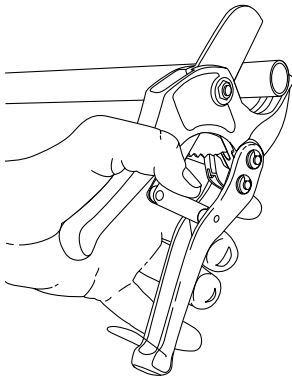

2. Next, slip a copper crimp ring onto the tube. Do not use hose clamps!

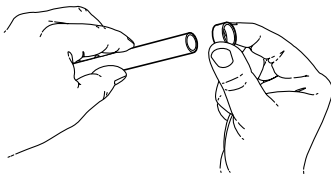

3. Now insert the fitting into the tube up to the fitting shoulder. Position the crimp ring 1/8 inch to 1/4 inch from the end of the tube. An improperly positioned ring may produce a weak connection. Ring may be squeezed to hold it in place until step 4 is completed.

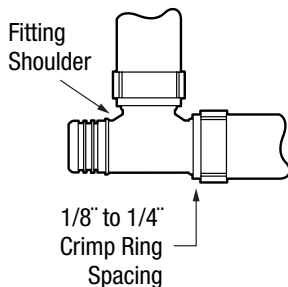

4. Position the tool so the crimp ring is completely covered by the tool jaws. Keep the tool at a 90° angle to the fitting and close it completely. Squeeze handles together to complete the crimp.

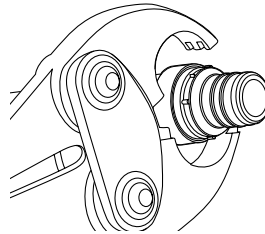

5. Open the tool handles to release jaws from the crimped fitting.

6. Measure the crimped ring with Zurn "Go/No-Go" gauge. **See table below.** Do not measure bumps on ring where jaws met. If "Go" on gage does not fit, or if "No-Go" does fit, then cut out connection, replace fitting and ring, adjust and calibrate the tool, and recrimp.

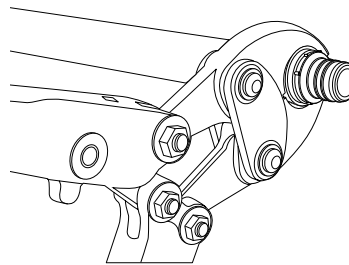

The following dimensions are the ASTM maximum and minimum crimped ring diameters for crosslinked polyethylene (PEX) pipe installations.

Standard Tube Size >	3/8"	1/2"	3/4"	1"	1-1/4"
Minimum Diameter	0.580"	0.700"	0.945"	1.175"	1.430"
Maximum Diameter	0.595"	0.715"	0.960"	1.190"	1.445"

Variation in ring diameter (out-of-round) should not exceed 0.006".

## Making the Connection with the Medium Crimp Tool

**Note:** Use the crimp tool only to install PEX tube/fitting systems meeting ASTM F1807 for brass or copper insert fittings and F2159 for plastic insert fittings.



**Important:** Always refer to the tube manufacturers' product assembly instructions when using the crimp tool.

1. Measure and cut the tube. Be sure you have a square burr-free cut. An uneven or jagged cut may cause an improper connection.

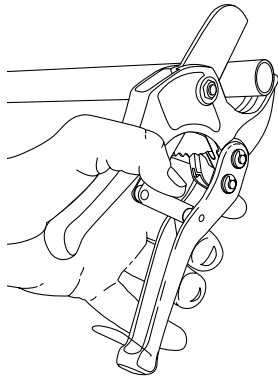

2. Next, slip a copper crimp ring onto the tube. Do not use hose clamps!

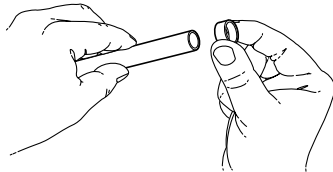

3. Now insert the fitting into the tube up to the fitting shoulder. Position the crimp ring 1/8 inch to 1/4 inch from the end of the tube. An improperly positioned ring may produce a weak connection. Ring may be squeezed to hold it in place until step 4 is completed.

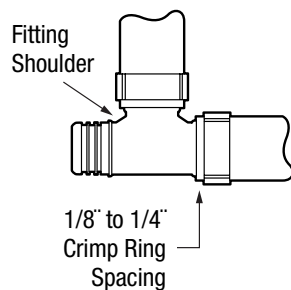

4. Position jaws squarely around the ring. Release upper handle to close jaws on the ring. Squeeze handles together to complete the crimp.

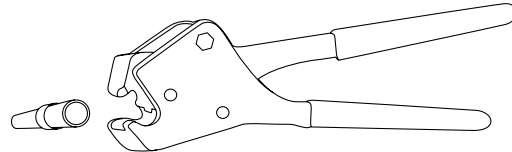

5. Pull back on moving handle to release jaws from crimped ring.

6. Measure the crimped ring with Zurn "Go/No-Go" gauge. See table below. Do not measure bumps on ring where jaws met. If "Go" on gauge does not fit, or if "No-Go" does fit, then cut out connection, replace fitting and ring, adjust and calibrate the tool, and recrimp.

The following dimensions are the ASTM maximum and minimum crimped ring diameters for crosslinked polyethylene (PEX) pipe installations.

Standard Tube Size >	3/8"	1/2"	3/4"
Minimum Diameter	0.580"	0.700"	0.945"
Maximum Diameter	0.595"	0.715"	0.960"

Variation in ring diameter (out-of-round) should not exceed 0.006".

## Using the Zurn Go/No-Go Gauge

After making a crimp connection, use the appropriate opening of this flat “Go/No-Go” Gauge to check your finished crimp. The “Go” opening should go freely across a crimped ring anywhere on its diameter with the possible exception of the upset area on the ring surface caused by the tool jaws closing. Do not force the gauge across the ring. The “No-Go” opening should not go across a crimped ring anywhere. If the crimp fails either test, cut out the fitting and replace.

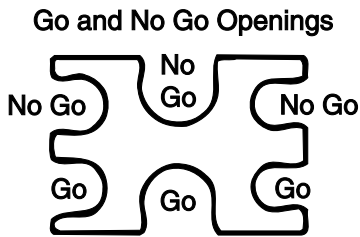

### DO:

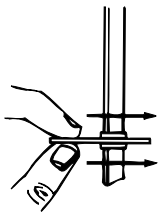

Always place the gauge opening on the crimp ring at a 90° angle for an accurate check.

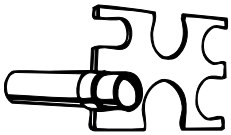

Be certain to use the gauge opening sized for the diameter of your tube.

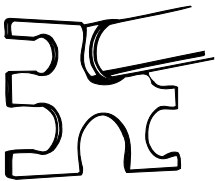

We recommend you check every finished crimp with this gauge.

### DO NOT:

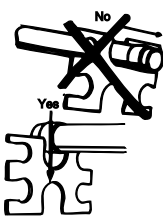

Do not slide the gauge onto the connection. Push it directly onto the crimp ring.

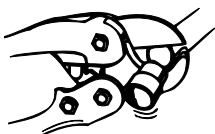

Do not try to save time by re-crimping a crimp that does not gauge properly. The fitting must be cut out and replaced.

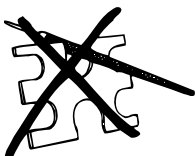

Do not modify the gauge opening for any reason. They have been carefully manufactured to .002-inch tolerance.

## Adjusting the Large Crimp Tool

Zurn Crimp Tools are factory set to provide proper crimps. This should be checked before use by making a test crimp connection and checking it with the crimp gauge. As long as the finished crimp connection gauges properly, there is no need to adjust the tool.

1. Loosen the bottom Locking Setscrew two turns using the hex wrench provided with the tool.
2. Close the tool until the jaws just touch and increased resistance is felt. This is the pre-load point.
3. Turn the top Adjusting Setscrew until the distance between the raised “+” marks on the handles is between 7 and 8-1/2 inches for QCRT2T, 3T, JT, and 4T. The distance for QCRT5T should be 13 inches. Tighten the bottom Locking Setscrew. **See Warning for QCRT2T, 3T, JT, 4T, and QCRT5T tool.**
4. Make a test crimp connection and check it with the “Go” and “No-Go” openings of the gauge. If the “No-Go” opening goes over the crimped ring, the tool is too tight. The distance between the “+” marks should be decreased. If the “Go” opening does not go over the crimped ring, the tool is too loose and the distance between the “+” marks should be increased.
5. Apply a light oil to the pivot points each time the tool is adjusted. **Failure to lubricate the tool will shorten its life.**

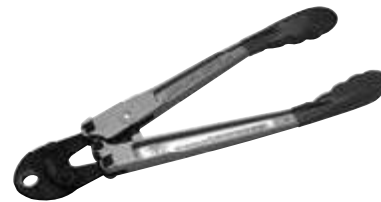

QCRT2T, 3T, JT, 4T

### WARNING:

Increasing the pre-load distance beyond 9 inches for the QCRT2T, 3T, JT, 4T or 13 inches for the QCRT5T will make the tool hard to use and shorten tool life because of excessive stress.



### Adjusting the Medium Crimp Tool

**Note:** Zurn Crimp Tools are factory set to provide proper crimps. This should be checked before use by making a test crimp connection and checking it with the crimp gauge. As long as the finished crimp connection gauges properly, there is no need to adjust the tool.

All crimp tools wear, which increases the crimp diameter after many crimps. When the crimps start to approach the maximum ring diameter, adjust the back pin. To adjust for a tighter crimp, remove the E-clip (for example, pop it off with a screwdriver) and slide the back pin head out about 1/4 inch. **Warning: The Adjustment Pin must not be pulled or pushed completely out.** Rotate the back pin until the line on the hex head points to the next highest number on the tool body, push the pin back in, and refit the E-clip. Five adjustments are available.

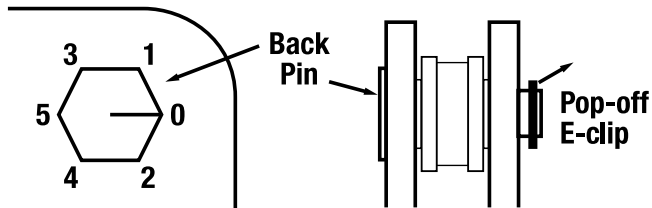

For a tighter crimp, turn mark on pin to the next number:

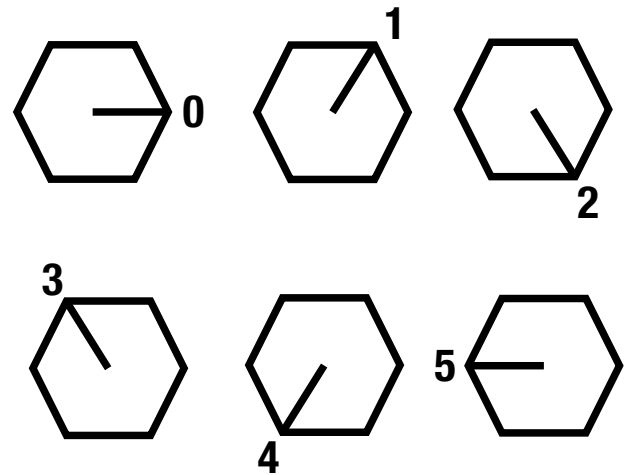

### Maintenance

For easier, better crimps and longer tool life, keep tool clean and rust-free inside and out. Lubricate all moving parts frequently with light oil.

## Stainless Steel Clamp Ring System

- One tool system
- Available in 3/8", 1/2", 3/4", 1"
- 15-year system warranty



## Listings

By NSF International as meeting the following standards:

ASTM F877

CAN/CSA B137.5

ASTM F2098

NSF Standard 14

## Making The Connection – Stainless Steel Clamp Ring

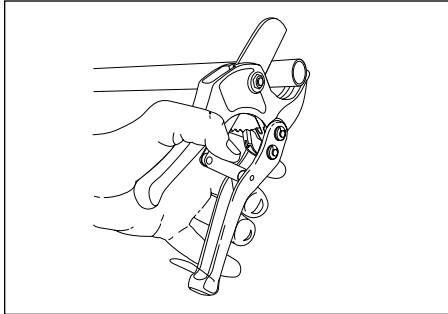

1. Measure and cut the tubing. Be sure you have a square, burr-free cut. An uneven or jagged cut may cause an improper connection.

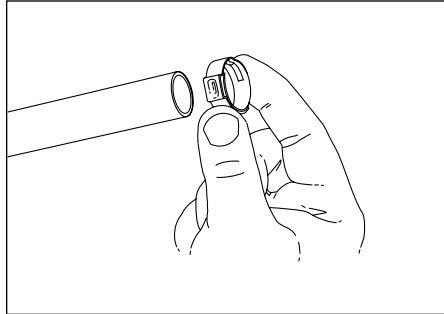

2. Slide the stainless steel clamp onto the tubing.

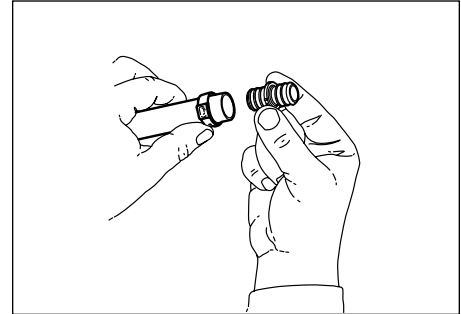

3. Push fitting into the tubing until the shoulder of the fitting is against the end of the tubing.

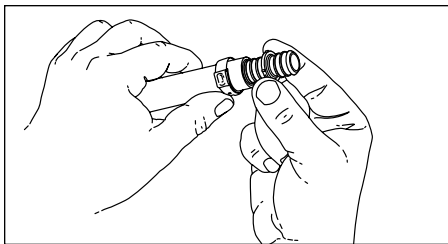

4. Position the stainless steel clamp so that it is 1/8" to 1/4" from the end of the tubing. **Important:** An improperly positioned ring may produce a weak condition.

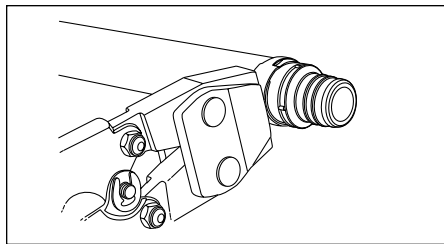

5. Position the open tool over the stainless steel clamp ear at a 90° angle. Completely compress the tool handles to close the tool over the clamp ear.

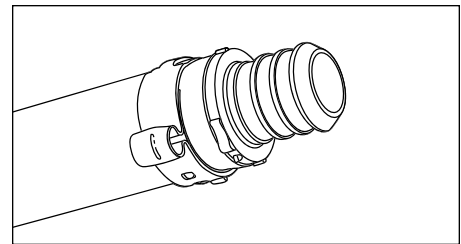

6. Remove the tool. **Note:** The crimp tool will not release until the connection has been made.

## Recommendations for Making Sweat Connections with Zurn PEX XL (Lead-Free) Fittings

Zurn PEX fittings are made from a very low lead brass material. This material can easily be sweated to copper tube or other copper alloy components with a few simple precautions.

1. Thoroughly clean the surface that will be sweated. This means wiping any dirt away followed by removing the surface oxide film by mechanical means such as a wire brush, sandpaper, or a sanding cloth. Do this just before you are ready to make the sweat connection because the oxide film quickly re-forms on the surface of the part.
2. Use a flux or paste that contains chlorine. Be sure that the flux or paste is suitable for potable water systems. This is typically indicated by the product being listed to NSF Standard 61. **Caution:** Do not allow these fluxes to come in contact with plastic fittings or components in the plumbing systems.
3. Use a solder that is suitable for potable water plumbing systems. Typically this will be a 95-5 Tin Antimony solder that is listed to NSF Standard 61.

4. The XL material does not transfer heat as rapidly as copper does so it is important to move the flame around while heating to assure even heating without creating hot spots. If the XL material is overheated, it will turn brown. If this happens you should disassemble the connection and start over with cleaning.
5. Because the XL material does not transfer heat as rapidly as copper, it will also stay hot longer once heated. Care must be taken once the sweat connection is made to be sure the connection is not disturbed until the solder has solidified. Careful application of a wet rag to shorten the cooling time will minimize the possibility that solder will run back out of the connection before solidifying.
6. Clean all remaining flux residue from the XL fitting and mating component or tube.

**Important:** Recommend making sweat connection with Zurn PEX XL Fittings

## Water Service Installation

Substandard tube performance may result if these instructions are not followed.

### Before You Start

#### Applications

Check local code requirements prior to installation.

#### Note:

Follow Installation Precautions when installing a Zurn PEX system.

### Inspection

#### Contaminated Soil

The soil in the area of installation must first be inspected and determined to be free of contaminants such as organic solvents and petroleum distillates. Zurn PEX tube is not recommended for underground use in areas of known soil contamination or where there is a high risk of chemical spills. Zurn PEX should not come into contact with soil near hazardous waste disposal sites or underground chemical or petroleum storage tanks.

#### Tubing

All pipe should be inspected prior to installation. Any areas that have sustained damaged in the form of cuts, punctures, or excessive abrasion as well as areas where the pipe has been kinked or pinched must be cut out.

### Preparation

#### Trench Bottom Preparation

When Zurn PEX tubing is to be buried during installation, it is essential that the supporting soil provide a stable and permanent support for the pipe. For buried tubing subjected to heavy overhead traffic a minimum cover of 24 inches is recommended. If light overhead traffic is anticipated, a cover of 12-18 inches is recommended.

**Important:** Do not use blocking to support Zurn PEX tubing or change the tubing grade. Do not install Zurn PEX tubing in, under, or above septic tanks, septic tank drainage fields, pits, or cesspools.

#### In Good Soil Conditions:

Zurn PEX tubing can be installed directly on the prepared bottom. The bottom must be flat with no hollows, no lumps, no rocks, and no other sharp objects as they could damage the tubing.

#### In Loose, Rocky Soil Conditions:

The trench should be excavated at least 6" deeper than the desired pipe depth and filled with suitable soils such as coarse sand or peagravel.

#### In Solid Rock Conditions:

The trench should be excavated at least 6" deeper than the desired pipe depth and filled with graded, tamped granular Class I material. The material should not be so fine as to wash out and cause subsequent settling of the tubing onto the solid rock.

#### In Unstable Soil Conditions:

The trench should be excavated at least 4" deeper than the desired pipe depth and filled with suitable soils such as coarse sand or peagravel.

### Installation

#### Thermal Expansion and Contraction

The linear expansion rate for Zurn PEX is approximately one inch per 100 feet of tubing for every 10°F change in room temperature. When installing Zurn PEX tubing, add 1/8" per running foot to accommodate thermal expansion or about 13 inches per 100 foot run. Snake the pipe uniformly along the trench. See Figure 2.

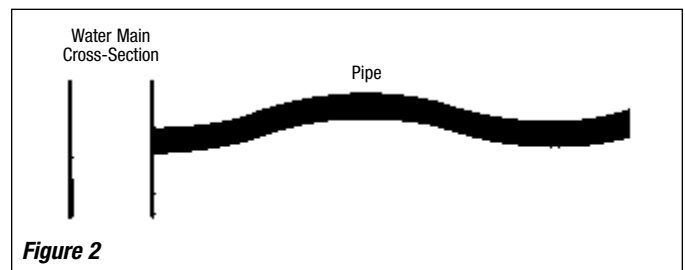

Figure 2

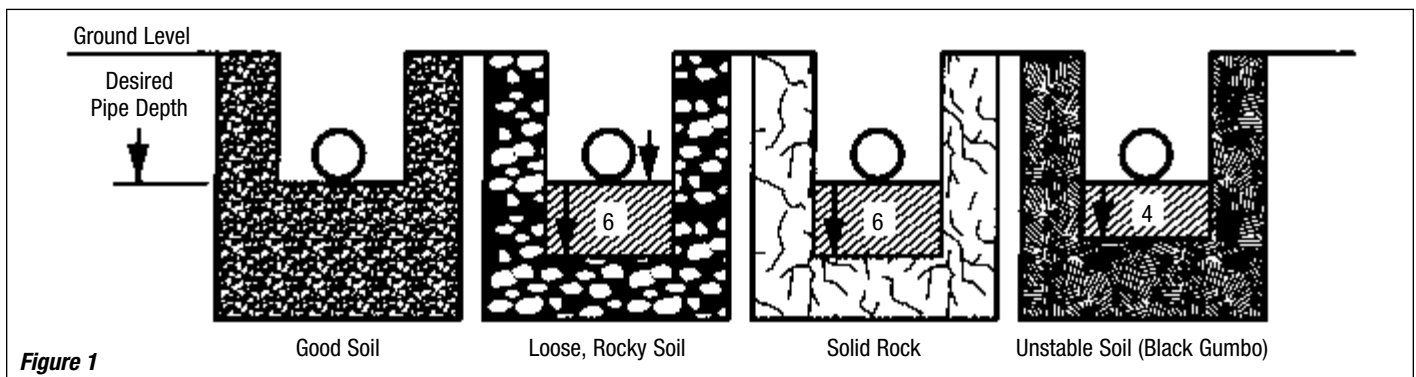

Figure 1

## Water Service Installation, continued

### Connecting to Curb Stop

A general rule to remember when installing Zurn PEX is: the less the effect of surrounding soil movements on tubing, the better. Other installations requiring double, or “S,” bends are not recommended as they are more prone to undesirable settlement which may subject the pipe to excessive stress. Figure 3 shows the recommended installation of a curb stop.

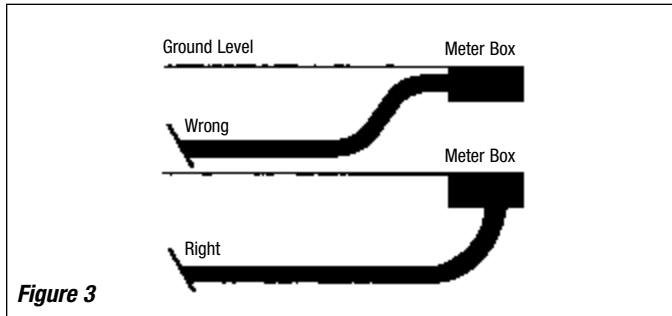

Figure 3

### Below Grade Water Service Fittings

Zurn PEX XL brass and CR fittings should not be used as water service fittings in below grade applications due to potential corrosion. Water service fittings are commercially available for these applications, such as connecting to the corporation and curb stops. They are typically molded from PVC and have a molded internal stiffener, an O-ring seal, a steel gripper, and a nut to hold it all together. They are available as coupling, male and female adapters, and spigot adapters. See Figure 4.

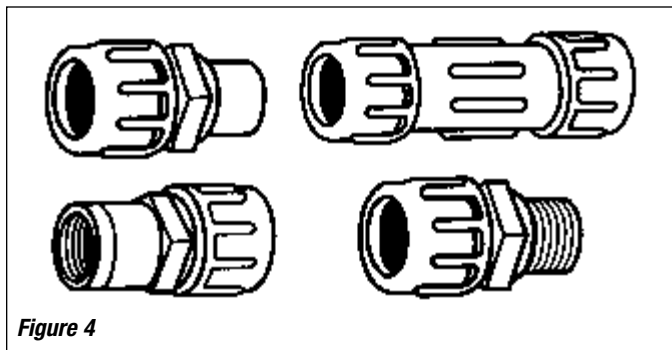

Figure 4

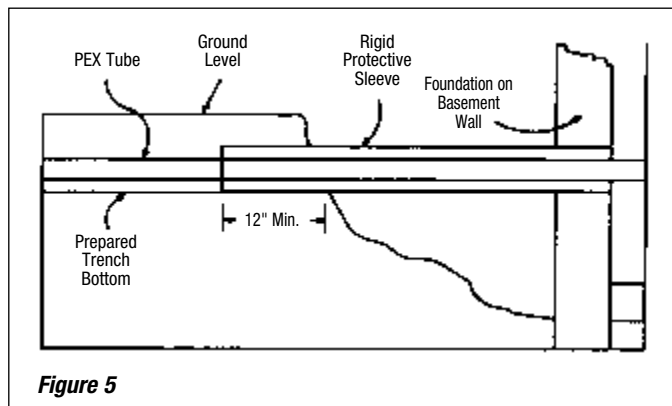

Figure 5

**Important:** Petroleum based caulks or sealants should not come into direct contact with Zurn PEX.

Plastic and bronze water service fittings and internal stiffeners that are suitable for copper tube sized (CTS) SDR9 polyethylene tube with a 160 psi pressure rating at 73°F will also work with Zurn PEX tube.

**Note** - Brass compression fittings that are normally used with copper tubing can also be used to connect Zurn PEX tube to corporation and curb stops. When compression fittings are used, a fitting with a split clamp is recommended to ensure that the internal stiffener will not move as a result of expansion and contraction of the pipe. Follow the fitting manufacturer’s recommendations for proper installation and use of their fitting.

**Note:** PTFE tape is the only recommended thread sealant for fittings used with Zurn PEX.

**Important:** Conventional pipe thread compounds, putty, mineral or linseed oil-based products, and unknown mixtures should never be used as these materials may cause damage to the pipe and fitting.

### Penetration of Basement or Foundation Walls

When Zurn PEX is run through a basement or foundation wall, it must be protected by a rigid sleeve that spans the distance from within the wall out to the undisturbed soil in the pipe trench. The purpose of this protective sleeve is to prevent shearing of the PEX tubing at the wall in the event there is settlement in the backfill around the wall. At the point where the sleeve terminates inside the foundation or wall, the space between the Zurn PEX and the sleeve should be sealed to prevent leakage into the building. See Figure 5.

### Pressure Testing

Water service lines should be pressure tested before the trench is backfilled with soil. Before applying pressure to the pipe, make sure that all air is bled from the system. A large pocket of air in the pipe can cause a severe water hammer that could damage the pipe. After a service line has been installed and filled with water, it should be tested using a pressure approximately 50 percent greater than the expected operating pressure. Run the test for at least one hour.

### Backfilling and Compaction

Before backfilling, be sure the trench is free of all foreign objects such as scraps of wood, metal, or glass which might puncture the pipe when buried in the trench. If the original soil removed from the trench is rocky or otherwise unsuitable, the pipe should be covered with a compacted 6" layer of coarse sand or peagravel before continuing the backfill with the original soil. See Figure 2.

**Important:** When the stone shooting technique is used to spread gravel or stone that underlays a basement concrete floor, Zurn PEX tubing should be protected from the direct impacts of the gravel during this process. Protecting the tubing can be accomplished by burying the tube in a trench and backfilling or by sleeving the tubing with a thin wall tube such as polyethylene irrigation tube.

## Zurn PEX In Concrete

Zurn PEX tubing may be embedded within a concrete slab, so long as it is installed at a continuous run, i.e; without fittings. When Zurn PEX is embedded in concrete, it should be sleeved where it enters and leaves the slab.

## Burying ZurnPEX Insert Fittings

ZurnPex insert fittings can be installed in or under concrete if the recommended installation practices are followed. Do not use petroleum based sealants, caulks or other compounds to protect the fittings from corrosion. These may adversely affect the ZurnPEX tubing.

## Using a Saran™ Wrap

1. Make a proper crimp connections following the procedures in the Zurn PEX Plumbing Design and Application Guide (ZPM03103).



2. Wrap the fitting and crimp rings several times with the Saran wrap.



3. Tape the Saran wrap in place. Be sure the tape does not contact the ZurnPEX tubing.

## Using a Foam Pipe Insulation

1. Make a proper crimp connections following the procedures in the Zurn PEX Plumbing Design and Application Guide (ZPM03103).



2. Place the foam pipe insulation over the fitting and crimp rings. The insulation should extend 3 inches beyond the crimp ring.



3. Tape the foam pipe insulation in place. Be sure the tape does not contact the ZurnPEX tubing.

## Using a Heat Shrink

1. Make a proper crimp connections following the procedures in the Zurn PEX Plumbing Design and Application Guide (ZPM03103).



2. The heat shrink must be applied using a hot air gun. Do Not Use Open Flames or a Torch.



3. Finished connection.

## Trench Cross Sections

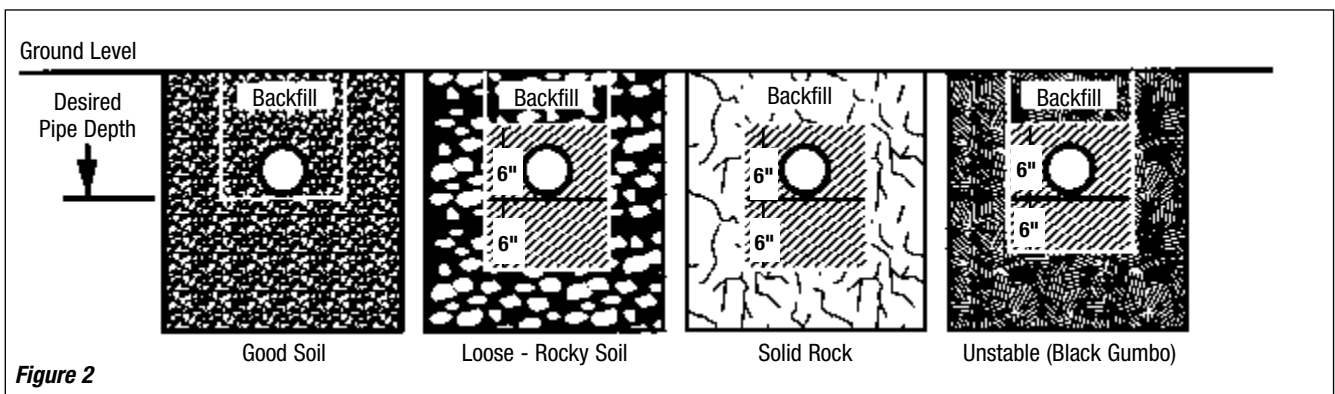

## Top Out Installation

### Uncoiling Zurn PEX Tubing

For ease of installation Zurn recommends using the Zurn PEX dual coil uncoiler, QDISP; the Zurn PEX pipe dispenser, QHD; or the Zurn PEX portable uncoiler, QPHU.

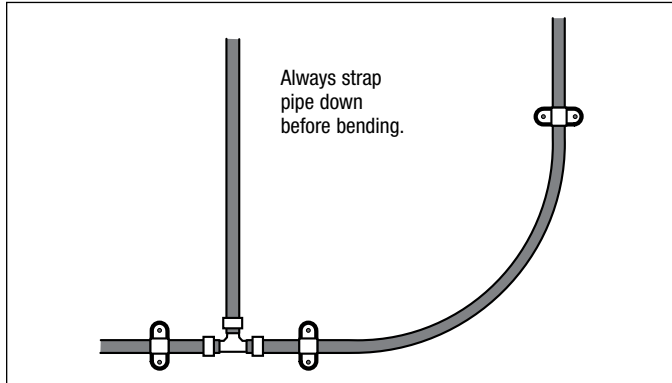

Zurn PEX straps and hangers hold pipe in position and prevent strain on fittings when the pipe is bent.

### Supporting Zurn PEX Distribution Lines

**Note:** Zurn PEX should be supported or strapped every 32" when hung from floor joists or running across rafters. When supporting tube bundles, use a strap to support the entire bundle.

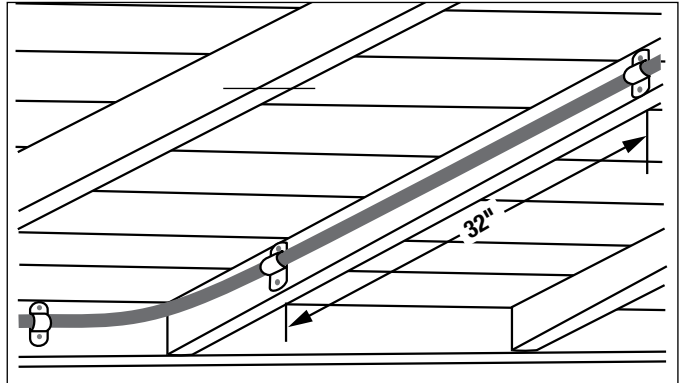

Horizontal runs should be supported every 32 inches.

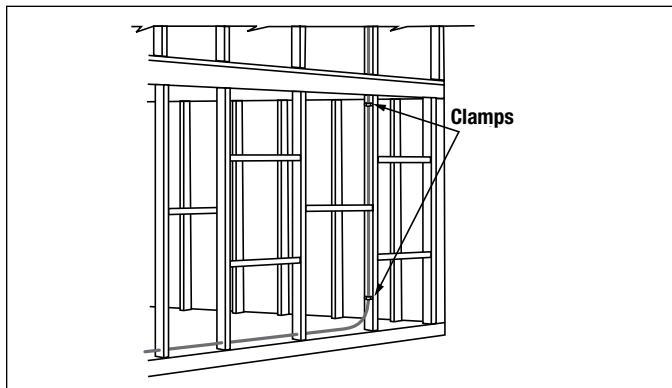

Vertical runs need support at every floor level.

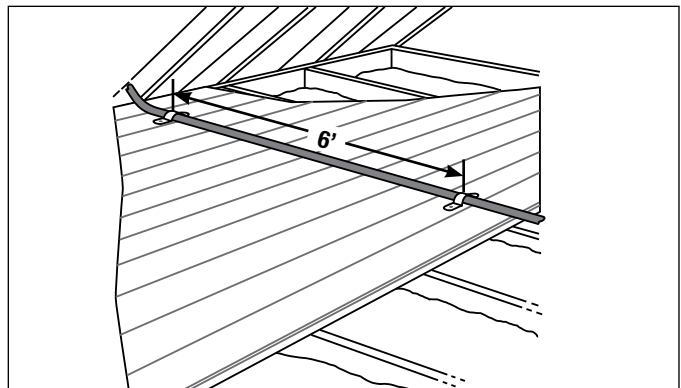

Straps can be as far as 6 feet apart if the pipe is continuously supported.

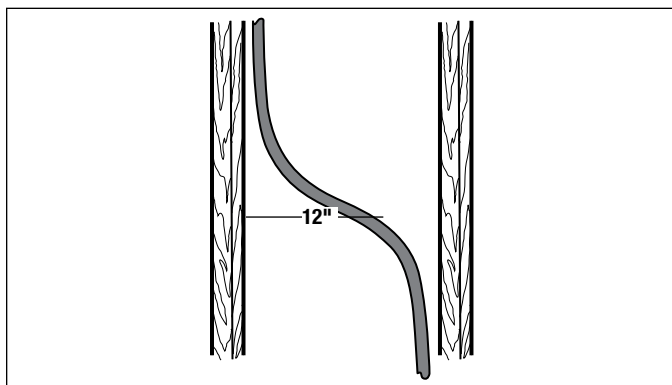

Since Zurn PEX tubing expands or contracts one inch for every 100 feet of pipe for every 10° of temperature change, you must allow for expansion and contraction in long runs with a 12-inch horizontal offset.

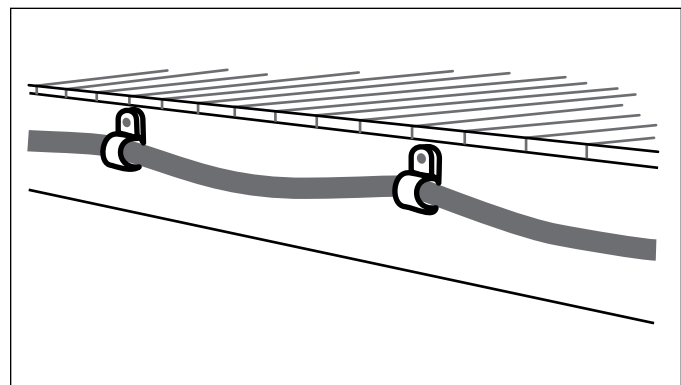

Always cut the pipe longer than necessary to allow some slack for any contraction in the pipe. 1/8" per foot of length is usually enough.

Strapping support should be firm but loose enough to allow the pipe to move back and forth as it expands and contracts.

## Top Out Installation, continued

**Important:** When running Zurn PEX tubing, be sure to keep it away from potential sources of heat. Maintain a minimum of 12 inches between Zurn PEX and any recessed light fixture and a minimum of 6 inches between Zurn PEX and any gas appliance vent. The use of zip ties to attach Zurn PEX to DWV piping is acceptable so long as the ties leave enough room for free movement of the tubing.

**Note:** When installing runs of Zurn PEX, it is sometimes necessary to pull one tube past another. Care should be taken to make sure that the friction of the moving tube does not burn or wear a notch in the stationary tube. If this occurs, the notched section of the tube must be cut out and replaced.

### Tubing Expansion

Zurn PEX tubing should not be pulled tight during installation. Adequate slack should be determined in order to prevent the tubing from exerting tensile loads on the connections to the fittings. Allow 1/8" per foot of tube length as slack. This should cover installations from 35°F - 160°F.

### Bending Zurn PEX Tubing

The minimum bend radius for Zurn PEX is 6 times the outside diameter of the tubing, when bending it with the natural curvature of the coil.

Tubing Size	Outer Diameter	Minimum Bend Radius
3/8"	.500"	3.00"
1/2"	.625"	3.75"
3/4"	.875"	5.25"
1"	1.125"	6.75"
1-1/4"	1.375"	8.25"
1-1/2"	1.625"	9.75"
2"	2.125"	12.75"

**Note:** If you must bend against the natural curvature of the coil, these minimums must be multiplied by 3.

### Metal Studs

Protective sleeves or bushings should be used on Zurn PEX tubing when penetrating metal studs. Sleeves and bushings are not required when penetrating ordinary wood or particle board if the holes are at least 1/8" larger than the tube size and tube movement is not restricted.

### Insulating Tubing

Zurn PEX is resistant to freeze damage; however, installation specific variables can affect the performance of the system if it is allowed to freeze up. In general, plumbing codes specify that tubing run through attics and exterior walls should be insulated. As such, Zurn PEX tubing should be insulated according to code requirements. Insulation that is typically used in copper and CPVC installations would provide equivalent protection for Zurn PEX tubing.

**Note:** When using expanding foam to insulate tubing, please contact Zurn for recommendations. While many expanding foams have been tested and have shown no adverse effects to PEX tubing, we cannot guarantee all foams are the same.

### Condensation

Zurn PEX tube transfers heat at a much slower rate than copper tube. This means that it is much less likely for condensation to form on the Zurn PEX tube than it is for copper in the same conditions. This does not mean that condensation cannot form under certain conditions. The site variables of relative humidity, ambient temperature and water temperature are all factors in the formation of condensation on any piping.

### Nailing Plates

Nailing plates should be used when Zurn PEX tubing is passing through a stud within 2" of a nailing surface. Using a nailing plate minimizes the possibility of damage to the tube from nails or drywall screws.

**Note:** Best results are achieved by using clamps, pipe insulators, and strapping designed for plastic plumbing systems.

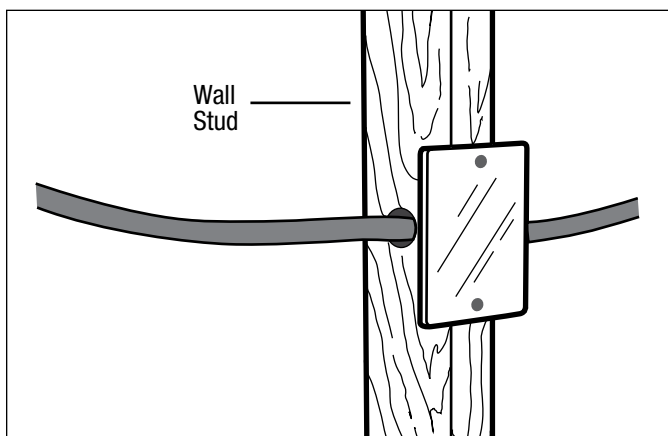

## Top Out Installation, continued

### Connecting Zurn PEX to Endpoints

There are a number of options for the installer to choose from when connecting Zurn PEX to the endpoint fixture. These options depend on local code requirements and fixture types. The following are some of the options available through Zurn. All of the fittings shown below can be found in the Zurn PEX Product Catalog.

**Important:** Zurn PEX expands and contracts one inch every 100 feet of pipe with every 10°F of temperature change. You must allow for expansion and contraction in long runs with a 12" offset.

### Floor Stub-Out

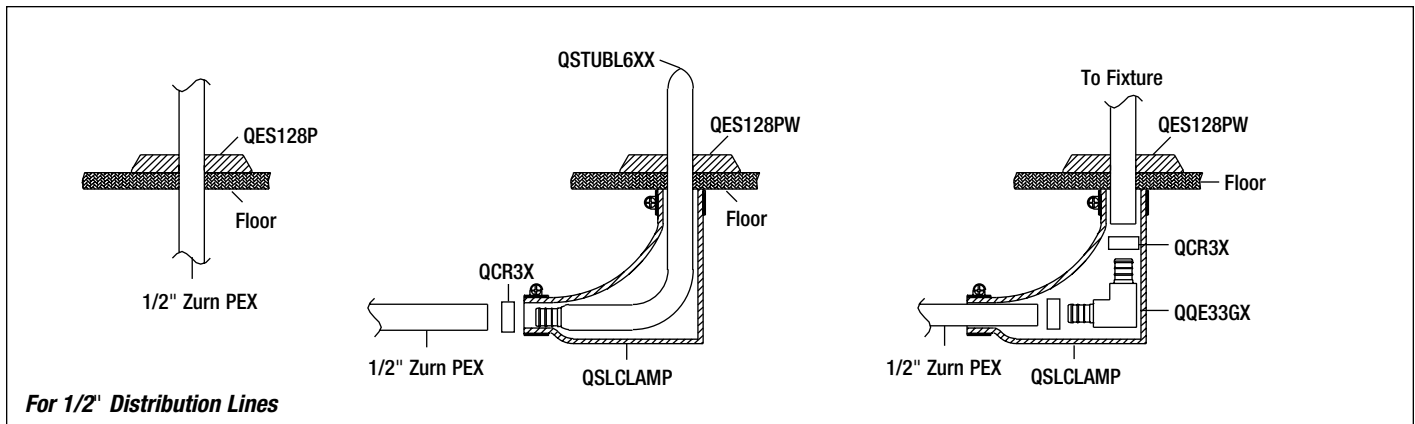
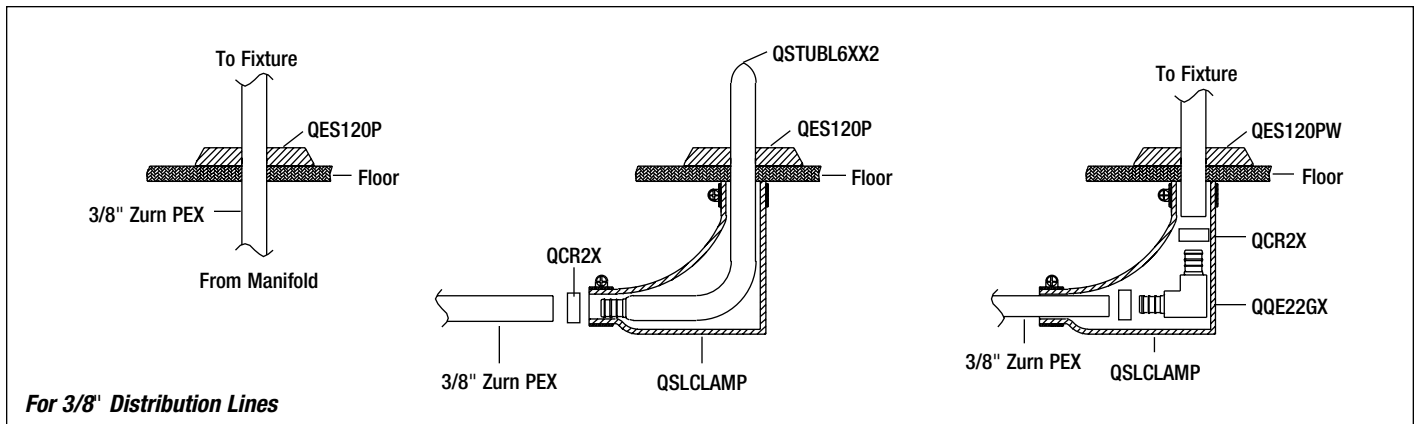



## Top Out Installation, continued

### Water Closet Fittings

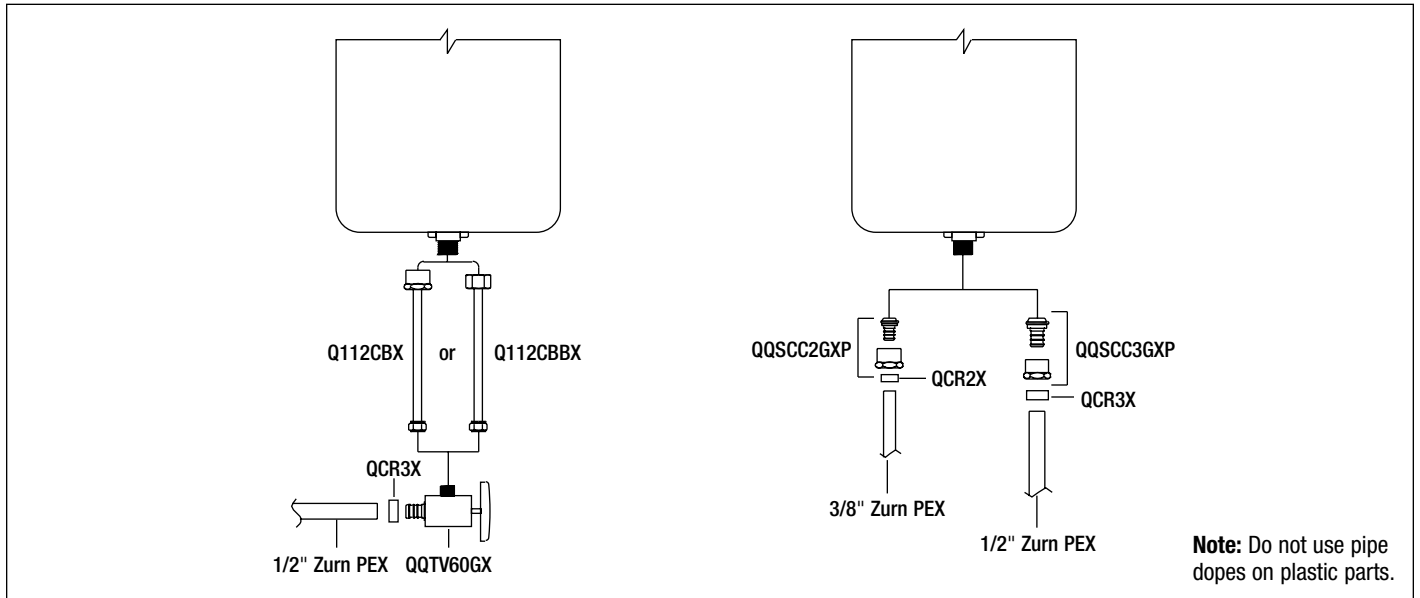

### Faucet Fittings

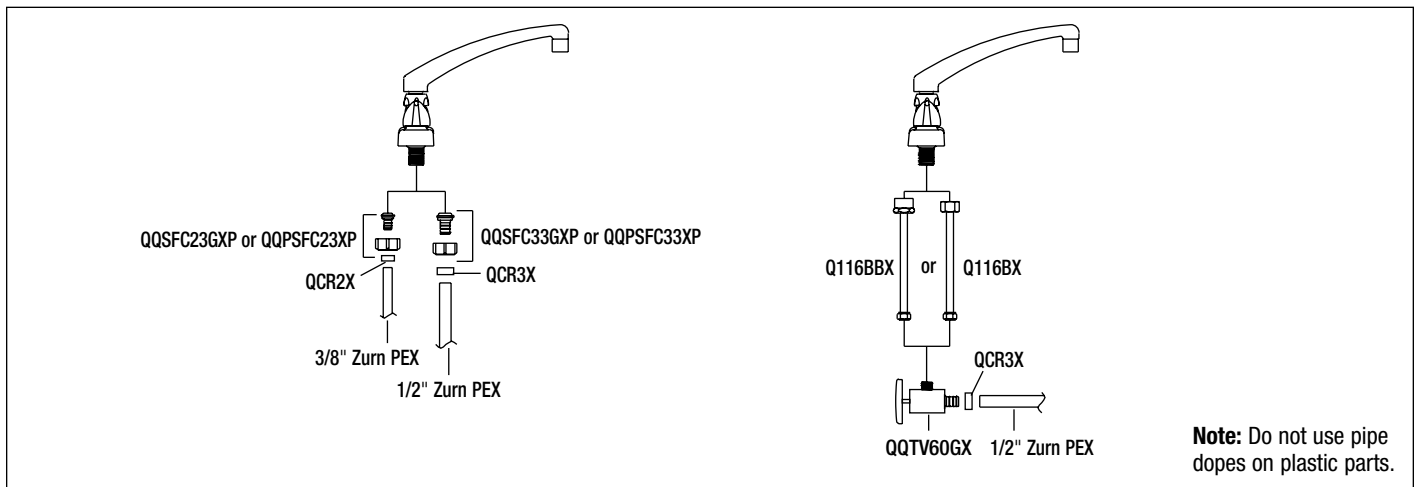

## Top Out Installation, continued

### Hose Bibb Connection

**Important:** Zurn PEX cannot support a hose bibb/hydrant. A drop-ear elbow or metal pipe must be used to support a hose bibb.

A hose bibb/hydrant supported by the structure can be supplied directly by Zurn PEX.

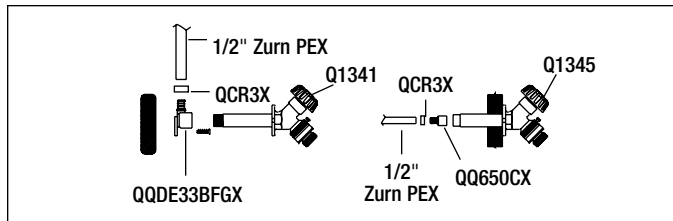

### Water Line Disinfection

Some code jurisdictions require disinfection of potable water service lines. The most commonly used standard is AWWA C-601-81, which specifies a chlorine concentration of at least 50 milligrams/liter (50 ppm) for 3 hours. The Southern Building Code Congress recommends 50 ppm for 6 hours. Zurn PEX will not be adversely affected by this exposure, but care should be exercised to avoid use of high chlorine concentrations (above 300 ppm) for more than 12 hours, as this could damage the pipe. The system should be thoroughly flushed at the end of any disinfection period.

### Pressure Testing

All Zurn PEX systems must be pressure tested in accordance with local codes after installation.

**Water** If water is used for pressure testing and the building is unheated, the system should be drained after testing to prevent freezing. Test pressure shall be at least equal to normal operating pressure but not less than 40 psi and not more than 225 psi. Test duration should not be less than 15 minutes.

**Air** If air is used for pressure testing, use a pressure no less than 40 psi but not more than 125 psi. The most common test pressure is 100 psi. The system shall be tested for a minimum of 15 minutes and the pressure shall not drop more than 8 psi in one hour. This is due to initial deformation of tube followed by slow expansion. Should the system lose over 8 psi in one hour, repressurize and test again. Should the problem persist, use one of the soapy solutions below for leak detection. Replace the fitting and retest.

### Leak Detector

For leak detection, use a diluted solution comprising of 2 oz. per gallon using any of the these dishwashing detergents: Ultra Palmolive® Original Scent, Joy® Dish Detergent, or Great Value Dish Detergent.

### Zurn PEX Installation Precautions

When installing a Zurn PEX system we recommend following the practices listed below to maximize the life of the system.

- Do not use supports that have sharp edges which could damage the tubing. Tube supports should allow free tubing movement.
- Do not install Zurn PEX within 6 inches of any gas appliance single wall vent. The exception is when a double walled B-vent is used, which has a minimum clearance of one inch.
- It is acceptable to run Zurn PEX tube next to normal HVAC ductwork, provided the tubing cannot be cut or abraded by sharp edges on the ductwork.
- It is acceptable to install Zurn PEX tubing within 12 inches of recessed light fixtures only when insulation has been installed with the specific purpose of protecting the tubing from excessive heat.
- When Zurn PEX tubing is free to uniformly expand, it is resistant to freeze damage in an accidental freeze. However, if Zurn PEX tubing is to be installed in an area subject to regular freezing conditions, we recommend that the tubing be insulated or otherwise protected as required by local code.
- Zurn PEX tubing is approved for water distribution only and should not be used for distribution of petroleum based products such as liquid petroleum (LP) or natural gas.
- Zurn PEX tubing should not be exposed to or stored in direct ultraviolet light.
- It is the responsibility of the installer to avoid mixing polybutylene and Zurn PEX components, which may cause plumbing system failure and result in severe water damage.

## Connecting Zurn PEX to a Water Heater

**Gas Water Heaters** Zurn PEX must be kept at least 6" away from the exhaust vent of a gas-fired water heater. This is easily accomplished by using flexible water heater connectors. When the inlet and outlet connections are well away from the exhaust vent, such as most heaters with side connections, Zurn PEX may be directly connected to the water heater.

When connecting to a power vented gas water heater, Zurn PEX tubing should be kept at least 6" away from a metal blower housing. If the blower housing is plastic, the Zurn PEX tube may be directly connected to the water heater.

**Electric Water Heaters** Zurn PEX may be connected directly to electric water heaters for residential plumbing applications. Zurn PEX has brass male and female threaded adapters and swivel adapters that can be used for this application.

**Tankless Water Heaters** Because of the extremely high temperatures produced by tankless water heaters, most manufacturer's require metal piping be connected to the heater's supply and discharge.

When installing Zurn PEX near a gas fired tankless heater, keep Zurn PEX tubing at least 12" away from exhaust piping, which can reach temperatures of 460°F.

### Water Heater Temperature and Pressure Relief Valves

Zurn PEX tubing may be used on the discharge side of a typical water heater temperature-pressure relief valve.

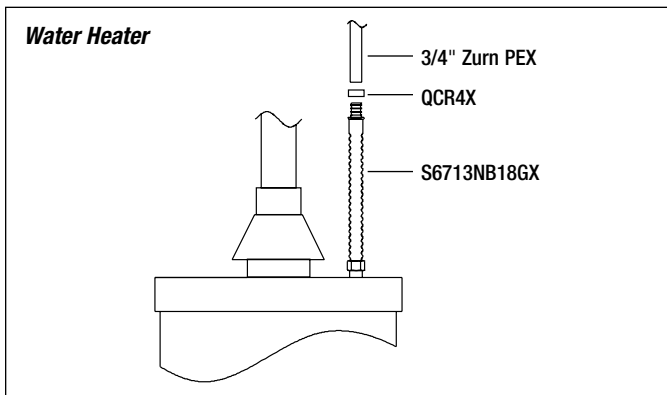

## Installation with a Zurn PEX Manifold

*QickPort® Manifolds efficiently and effectively deliver hot water faster. The QickPort Manifold distribution system offers a variety of benefits including:*

- Controllable water distribution
- No in-line below floor fittings
- Increased water flow and pressure
- No hidden fittings behind the wall
- Available with or without full flow ball valves

The QickPort Manifold is also available with soft water ports to maximize resource conservation in applications with water softeners.

### Sizing the QickPort Manifold System

The manifold system allows individual hot or cold lines to be connected to each fixture inlet from the manifold. To size a manifold, count the number of cold water locations in the house as well as outside hose bibbs. Also, include a line for the refrigerator ice maker, particularly if the refrigerator is not on the same wall as the kitchen sink. Next, count the number of hot water locations in the house. Choose your manifold according to the desired number of hot and cold ports.

**Important:** Do not attempt to supply two locations from a single manifold outlet as it may result in unsatisfactory performance and may violate local plumbing code. For a double vanity that has a continuous cabinet, some local codes will allow the second lavatory faucet to be connected to the first by using a tee fitting under the vanity. The installer must first verify that this is acceptable according to local code prior to sizing.

**Important:** All unused ports should be capped, even if the valve is closed.

### Locating the QickPort Manifold

The manifold should be installed in an accessible area very near the water heater, but not closer than 18" from the water heater outlet.

**Note:** In a typical installation, the QickPort should be no closer than 18" from the water heater outlet.

If the manifold must be more than 8 feet from the water heater, we recommend installation of a circulatory loop between the water heater and the manifold. The water temperature in the loop must be less than 140°F and the chlorine must be less than 2 ppm.

**Important:** The QickPort must be located in an area that will not be covered permanently with sheetrock, plywood, or paneling. The QickPort must also be protected from freezing temperatures.

## Installation with a Zurn PEX Manifold, continued

### Mounting the QickPort Manifold

The QickPort can be secured to a wall in a variety of ways.

**Option 1:** Attach the assembled QickPort to the QPMB bracket (optional). Screw the QPMB bracket to the studs of the manifold cavity. (Fasteners supplied by others.)

**Option 2:** Attach the assembled QickPort to a 1 x 4 that is secured between the studs. (Fasteners supplied by others.)

**Option 3:** Attach the assembled QickPort directly to a block wall. (Fasteners supplied by others.)

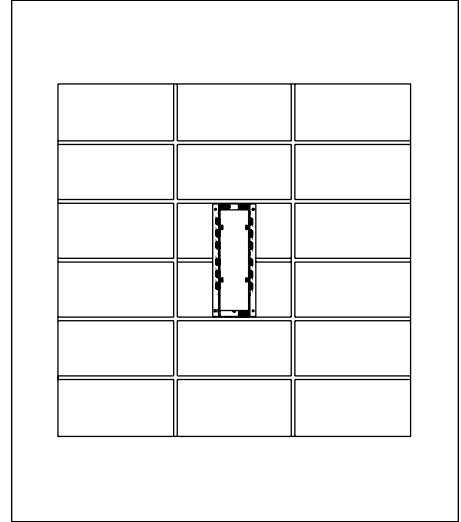
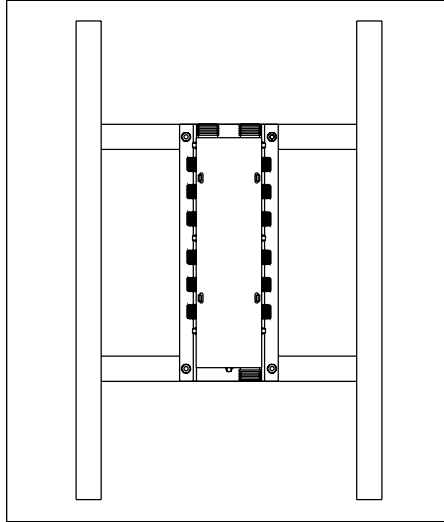
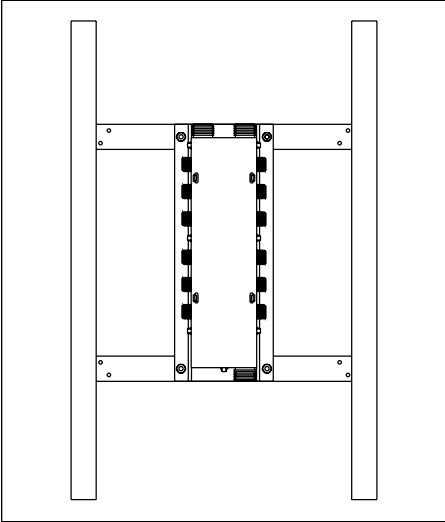

### Connecting Service Lines

Water can be supplied to the QickPort by 3/4" or 1" Zurn PEX tubing. These inlet connections are straight pipe thread and require specific Zurn fittings to seal properly.

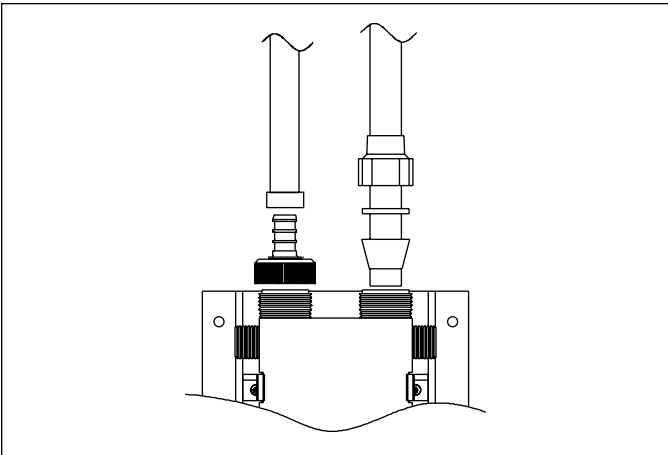

Connect the supply tubing to the appropriate header using one of the approved Zurn QickPort inlet/outlet connections as specified in the Zurn PEX product catalog.

**Important:** Standard NPT fittings will not seal on these connections. These connections do not require pipe thread sealant, and none should be used as adverse effects may result. ALL connections to the manifold use a rubber or plastic cone seal.

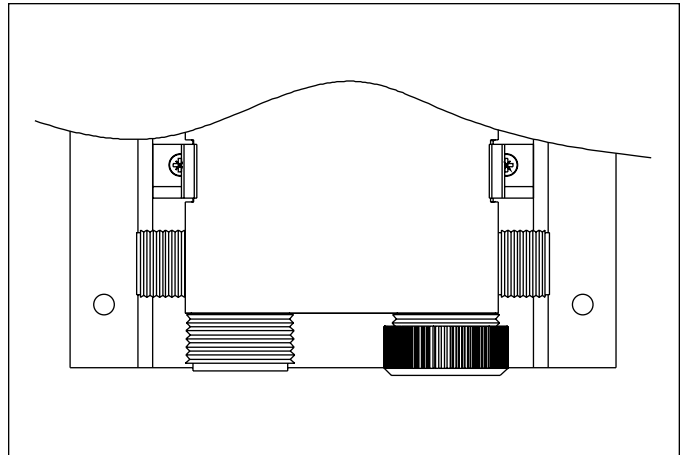

The 1" outlets can be fitted with a crimp x swivel or nut-ring-cone connector. These can then be used to supply high flow rate fixtures such as whirlpool baths, hose bibbs, etc. The unused 1" outlets need to be sealed using a 1" brass cap (Part No. QTC5FBG).

## Installation with a Zurn PEX Manifold, continued

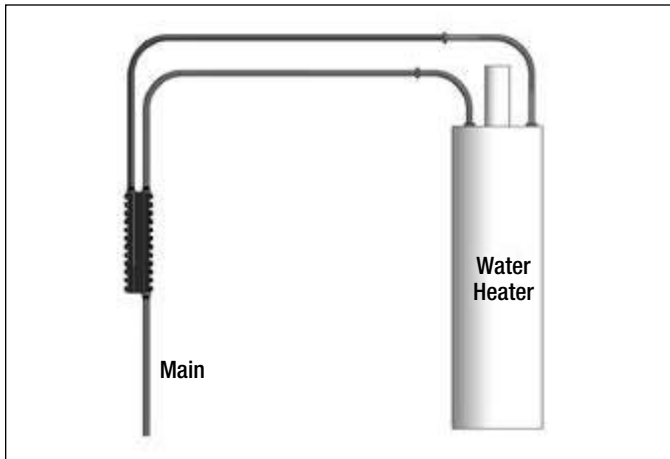

Supplying the water heater from the manifold.

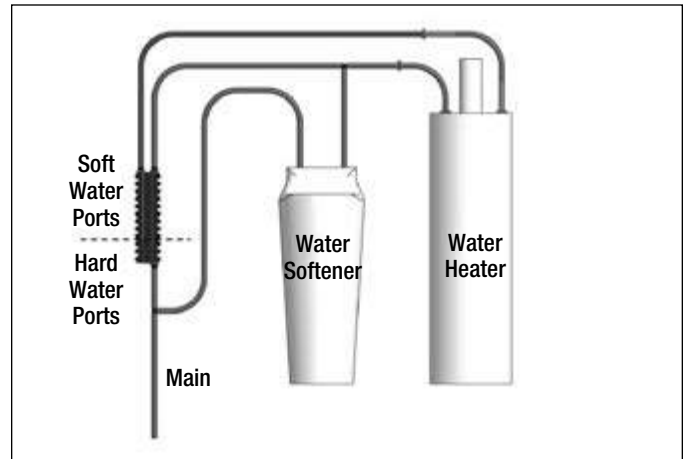

Supplying the water heater and the water softener from the manifold.

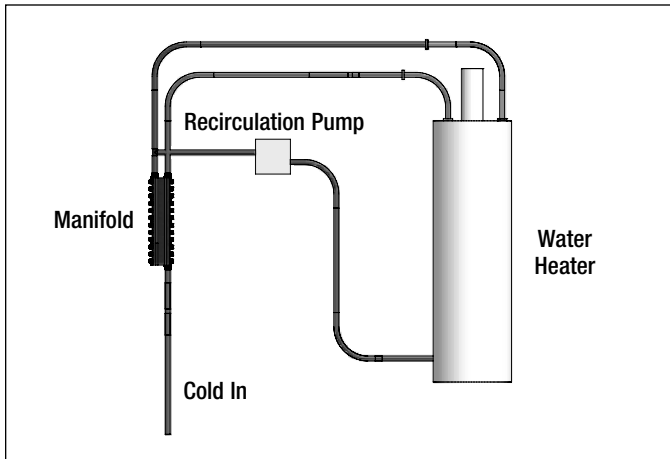

Recirculation pump with manifold.

### Zurn PEX Distribution Lines

The 3/8" or 1/2" Zurn PEX distribution lines must leave the manifold in a straight line that is perpendicular to the long axis of the manifold. The tube must be clamped or strapped between the manifold and the first change of direction to keep any bending stress from being applied to the manifold outlet. Be sure that the clamp or strap keeps the tube in the same plane as the manifold.

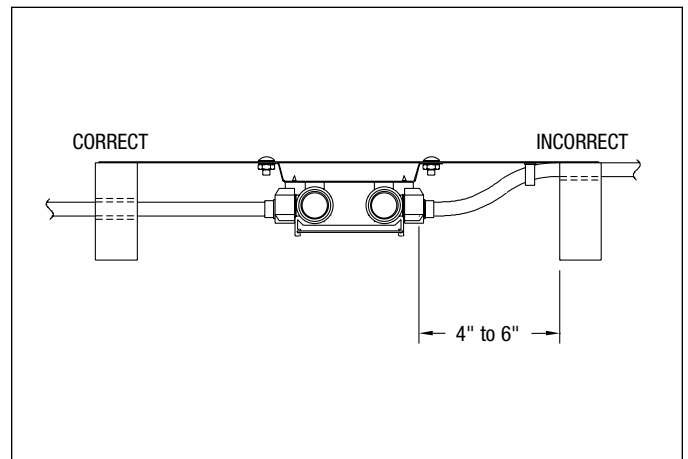
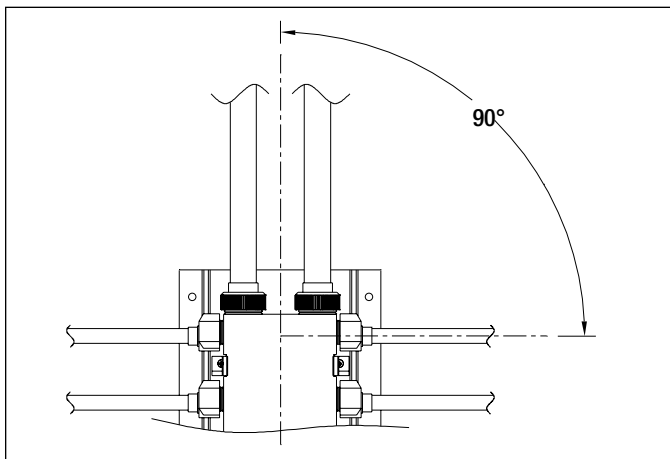

## Connecting Zurn PEX Tubing to the QickPort Manifold

There are a number of options for the installer to choose from when connecting Zurn PEX tubing to the QickPort Manifold. These options depend on local codes, crimp tool availability, and installer/homeowner preference. The following illustrate some of the connection options available through Zurn. All of the fittings shown below are available through the Zurn PEX product catalog.

### QickClamp Connections

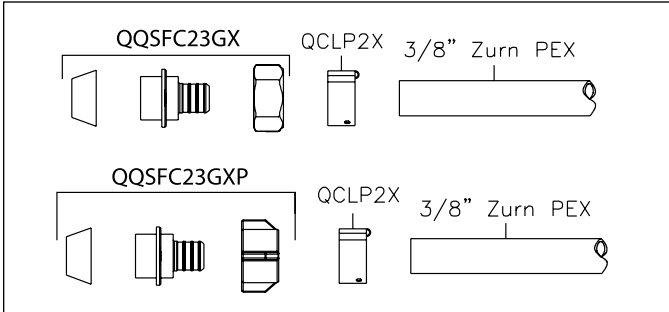

For 3/8" Distribution Lines

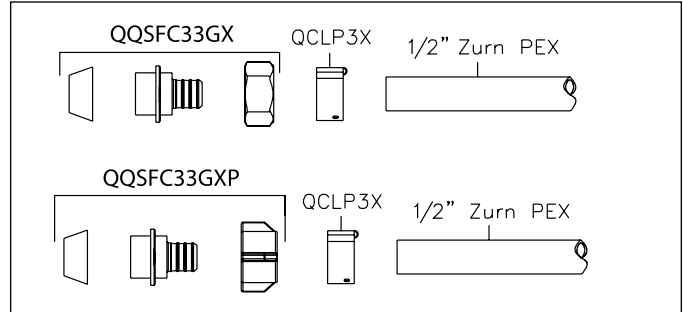

For 1/2" Distribution Lines

### Zurn PEX CR Valve Connections

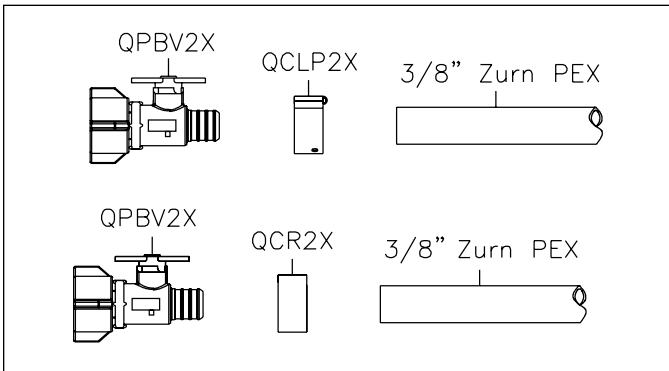

For 3/8" Distribution Lines

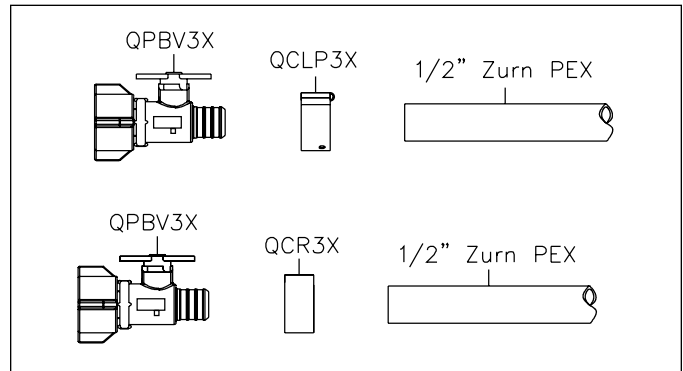

For 1/2" Distribution Lines

### Qicktite Connections

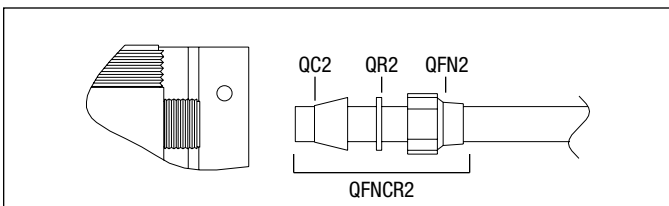

For 3/8" Distribution Lines

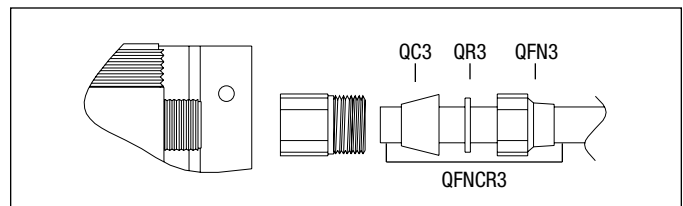

For 1/2" Distribution Lines

## Connecting Zurn PEX Tubing to the QickPort Manifold, continued

### Unused Port Connections

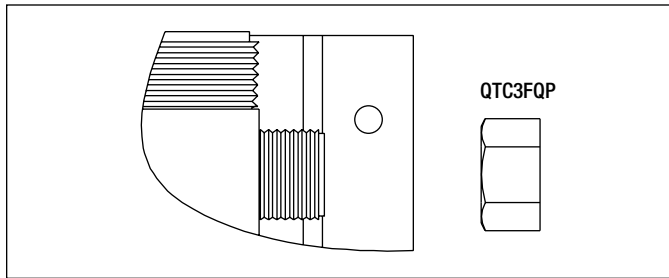

### Bundling Zurn PEX Distribution Lines

The distribution lines are run in the most direct route to the endpoint fixture. If the tubing is not immediately connected to the manifold, both ends of the tubing should be labeled.

The hot and cold distribution lines can be bundled together if local codes allow. Bundles should be wrapped with a heavy gauge plastic sheet at locations where fasteners are attached. This sheet may be fastened using tape or nylon wire ties. Apply the tape to the plastic sheet, not the tubing bundle. This will allow the tubing to slide inside the sheet.

**Note:** Tubing run on a continuous support such as a floor in an attic may be strapped at six-foot intervals; however, when hung from floor joists or running across rafters, Zurn PEX tube should be supported or strapped every 32".

### Completing the Installation

Once installation is complete, it is recommended that all ports be labeled accordingly so that they may be shut off to a particular fixture. Zurn offers pre-printed label kits for a professional look. The labels are self-adhesive and can be applied directly to the manifold.

Zurn also offers decorative access panels that can be used to cover the manifold. Zurn access panels come with a frame that can be fastened to the sheetrock with adhesive or screws for easy installation. The panels snap into place and are flush with the sheetrock.

### Installing a Zurn PEX XL or Zurn PEX CR Fitting Under Concrete

As a matter of good practice, it is best to avoid placing fittings in an area where concrete would have to be removed if repairs are necessary. However, there are occasions at which burying a fitting in or under concrete is unavoidable. When circumstances warrant the burial of a Zurn PEX fitting in or under concrete, it is necessary to follow two important guidelines in order to prevent compromising the integrity of the system.

1. A proper connection must be made. Please refer to pages 7-13 to ensure a proper connection is made based on your choice of clamp system.
2. The fitting connection must be protected from corrosion induced by contact with the surrounding soil or concrete.

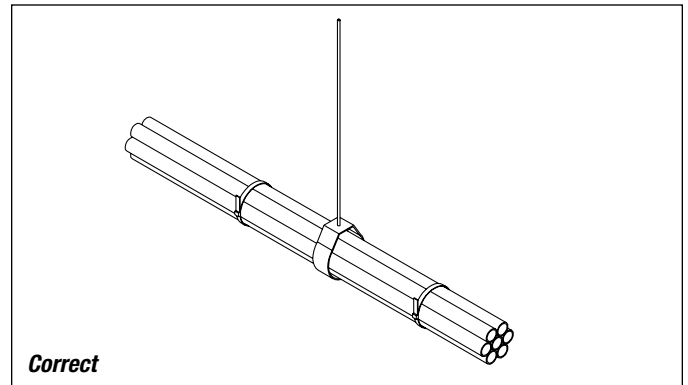

**Correct**

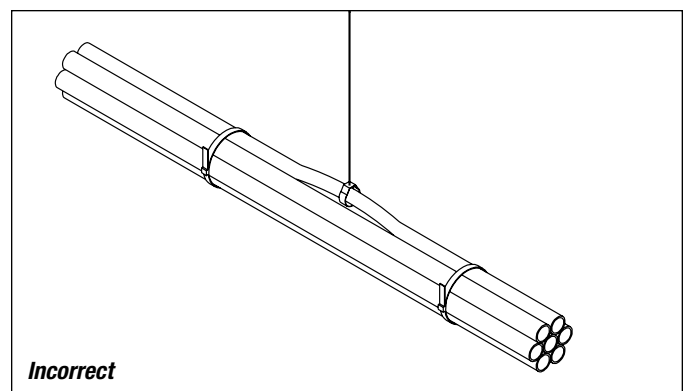

**Incorrect**

**Important: DO NOT** hook one tube to support the entire bundle. Straps should go around the entire bundle.

There are three different methods that Zurn recommends as a means of protecting buried fittings from corrosion.

**Foam Pipe Insulation** – Foam Pipe Insulation can be used as an effective method of covering the fitting and clamp rings from corrosion. For proper application please refer to manufacturer instructions.

**Plastic Film** – Several layers of a plastic film such as Saran Wrap may be used to cover the fitting and clamp rings without damage to the tubing. While the film generally sticks to itself, to make sure that the film stays in place during installation, tape should be wrapped around the film at the body and the ends of the fitting. **Note: The tape should not come in contact with Zurn PEX tubing.**

**Heat Shrink Sleeves** – Heat Shrink sleeves are only used to protect couplings. The sleeve should be placed on Zurn PEX tubing and moved away from the crimp area prior to making a connection. Once the tubing has been connected to the fitting, the heat sleeve should be centered on the coupling with 3 inches of sleeve beyond the fitting on either side. Follow the manufacturer's instructions to shrink the sleeve using a hot air gun. When the shrinking process is complete, the sleeve should be tight on the Zurn PEX tubing, fitting, and crimp ring or clamp.

**Important:** Do not use more heat than is required to shrink the sleeve. Do not use flames or a torch to shrink the sleeve.

## NSF Standards, Descriptions, and Markings

Zurn Pex utilizes NSF International as its third party listing agency for NSF and ASTM standard compliance for the majority of our products. NSF International is a well known and well respected listing agency. Zurn Pex listings can be found on the NSF International website at [www.nsf.org](http://www.nsf.org).

**NSF Standard 61** is the standard that establishes minimum health effects requirements for the chemical contaminants and impurities that are indirectly imparted to drinking water from products, components, and material used in drinking water systems. Zurn PEX systems intended for potable water meet the requirements of NSF 61.

**NSF Standard 61 – Annex G** is the annex to NSF Standard 61 that tests for the amount of lead in a product for conformance to California and Vermont low lead legislation. Zurn PEX systems intended for potable water meet the requirements for NSF 61 – Annex G.

**NSF Standard 14** establishes physical, performance, and health effects requirements for plastic piping system components and related materials. Zurn PEX systems intended for potable water meet the requirements of NSF 14.

### NSF Markings

- **NSF-pw** indicates compliance to NSF Standards 61 and 14.
- **cNSFus-pw** indicates compliance to NSF Standards 61 and 14 as well as compliance to Canadian and U.S. standards referenced in the respective national plumbing codes.
- **cNSFus-pw-G** indicates compliance to NSF Standards 61 and 14 including Annex G (low lead) as well as compliance to Canadian and U.S. standards referenced in the respective national plumbing codes.

## ASTM Standards and Descriptions

**PEX plumbing systems are frequently described in one or more different ASTM Standards. Zurn PEX has different PEX systems and components of each system may be described in different ASTM standards.**

**ASTM F 876** is the standard that specifies the material properties and the dimensions for PEX tube. This tubing is "copper tube size" meaning that the PEX tube has the same outside diameter as copper tube. All of the tube made to this standard has the same pressure-temperature ratings of 160 psi @ 73°F and 100 psi @ 180°F. For heating applications, the standard also has a pressure-temperature rating of 80 psi @ 200°F. Zurn PEX tube meets the requirements of ASTM F 876.

**ASTM F 877** is the standard that specifies the performance requirements for a PEX system, tube and fittings together. It has requirements for Minimum Burst at 73°F and 180°F, Sustained Pressure Test (1000 hours) at 73°F and 180°F, Thermocycling at 100 psi and Excessive Temperature and Pressure for 30 days to simulate a water heater malfunction. The Zurn PEX systems meet the requirements of ASTM F 877.

**ASTM F 1807** is the standard for brass or copper insert and crimp fittings. This standard specifies acceptable materials for these fitting and specifies the dimensions for the insert or barbed portion of the fittings. It also gives the dimensions and the material specifications for the copper crimp rings and the finished crimp dimensions. These fittings, when tested with PEX tube have to meet the performance requirements for PEX systems as required in ASTM F 877. Zurn PEX brass insert fittings and copper crimp rings meet the requirements of ASTM F 1807.

**ASTM F 2159** is the standard for plastic insert and crimp fittings. This standard specifies the acceptable materials and dimensions for the fittings. It also has some test requirements for evaluating the quality of the molding process that was used to make the fittings. These fittings, when tested with PEX tube have to meet the performance requirements for PEX systems as required in ASTM F 877. Zurn PEX plastic insert fittings meet the requirements of ASTM F 2159.

### Other ASTM Fitting Standards

**ASTM F 1960** is the standard for "Cold Expansion Fittings" as sold by Wirsbo/Uponor. Zurn PEX tube can be used with these fittings so the standard number is included in the print string on our tube but the system is not covered by the Zurn PEX warranty.

**ASTM F 2080** is the standard for "Cold Expansion Fittings with Metal Compression Sleeves" as sold by Rehau. Zurn PEX tube can be used with these fittings so the standard number is included in the print string on our tube but the system is not covered by the Zurn PEX warranty.

**ASTM F 2098** is the standard for a "Stainless Steel Clamp" to be used in place of a copper crimp ring for brass or copper insert fittings meeting the requirements of F 1807 or plastic insert fittings meeting the requirements of ASTM F 2159. Zurn PEX does sell rings meeting the requirements of this standard and they are covered by a special, limited time warranty.

### Detailed Description of the

#### Test Requirements of ASTM F 877 for PEX Plumbing Systems

##### Burst Test at Room Temperature and 180°F

In this test, sample assemblies are subjected to a constantly increasing pressure until something fails. The minimum acceptable pressure depends on the size of the tube, but it is a minimum of 620 psi at room temperature and 275 psi at 180°F. The pressure is increased at a rate that will cause failure in about 1 minute.

The significance of this test is that it demonstrates that the short term strength of the connection exceeds the strength of the tube.

##### Sustained Pressure Test at 180°F

In this test, sample assemblies are placed on a continuous pressure test while in an oven or water bath at 180°F. The pressure depends on the size of tube but it is a minimum of 190 psi. These samples are kept on test for 1000 hours (six weeks) and they must not leak or come apart.



## ASTM Standards and Descriptions, continued

The significance of this test is that it shows that at elevated temperature, the connection is capable of holding the same elevated test pressure that is required of the tube. Water pressure in homes is typically between 40 and 60 psi so this test pressure is at least 3 times the usual pressure in a plumbing system.

### Thermocycle Test

In this test, sample assemblies are pressurized to 100 psi with nitrogen gas. They are then immersed in a hot water bath at 180°F and held there for a minimum of 2 minutes. After that the samples are moved to a cold water bath and held there for 2 minutes. This cycle is repeated 1000 times and the samples must not leak.

This test demonstrates that the connection between the tube and fitting will remain leak free even as the temperature changes. This test is very harsh because nitrogen gas is a much smaller molecule than water and it will leak in situations where water would not.

### Excessive Temperature and Pressure Test

In this test, sample assemblies are pressurized to 150 psi and kept in an oven at 210°F. The samples are maintained at this condition for 720 hours (30 days) and they must not leak or come apart.

Most domestic water heaters have temperature/pressure relief valve that operate when the temperature exceeds 210°F or the pressure exceeds 150 psi. This test demonstrates that even at the extreme conditions of a water heater malfunction, the system is capable handling the pressure and temperature without leaking or coming apart.

### Other Tests

In addition to the required ASTM tests, Zurn PEX has some in-house tests that our systems are expected to pass. Even though water hammer is typically not an issue with PEX plumbing, there are instances when PEX may be used in combination with a rigid piping material such as copper. In this instance, the PEX system may be subjected to pressure surges from water hammer in the rigid material. Zurn PEX systems are subjected to a minimum of 250,000 water hammer shocks with pressure surges up to 400 psi. They must withstand this without leaking or blowing apart.

250,000 water hammer shocks is equivalent to 25 shocks a day for 25 years. This test demonstrates that the connections do not fail or fatigue with repeated pressure shocks.

PEX tube, like all tubes, expands and contracts with changes in the air temperature and the water temperature in the tube. Because of this, connections are subjected to some flexing as the tube expands and contracts. Zurn PEX systems are subjected a flexing test for 250,000 cycles while being pressurized at 200 psi.

This test is intended to demonstrate that the connections do not leak even when there is flexing in the system caused by expansion and contraction of the tube.

### A Summary of Zurn PEX Systems, Components, and Applicable ASTM Standards

Zurn PEX Tube

ASTM F 876, F 877

Zurn PEX Brass and Copper Insert Fittings

ASTM F 1807

Zurn PEX Plastic Insert Fittings

ASTM F 2159

Zurn PEX Quickclamp

ASTM F 877 as a system with Zurn PEX tube and Zurn PEX copper, brass, and plastic insert fittings.

Zurn PEX SSC

ASTM F 2098

## System Sizing and Design

The following tables can be used to assist the designer when designing a plumbing system using Zurn PEX.

**Equivalent Tubing Length:** Along with the pressure loss through the supply tubing, any pressure loss through any other components in the system must be taken into account, such as fittings, shut off valves, etc. Below is a chart that shows the equivalent length of tube in feet per one fitting for Zurn fittings.

**Note:** Some local codes require that water velocity through tubing cannot exceed 8 ft/s. This cut-off is highlighted on the Pressure Drop for Zurn PEX Tubing. The maximum velocity on this chart is 12 ft/s. This pressure loss in this chart is represented in PSI/foot.

Fitting Equivalent Length (Feet of Tube)							
Zurn PEX XL and Zurn PEX DZR Fitting	Tubing Size						
	3/8"	1/2"	3/4"	1"	1-1/4"	1-1/2"	2"
Coupling	2.7	2.8	3.5	1.0	0.9	0.5	2.6
Elbow	9.2	8.0	9.2	7.8	10.0	12.5	22.1
Tee - Run	3.3	2.4	3.5	2.7	1.0	0.0	3.5
Tee - Branch	9.6	7.1	8.6	5.5	9.0	12.3	19.6

Fitting Equivalent Length (Feet of Tube)			
Zurn PEX CR Fitting	Tubing Size		
	1/2"	3/4"	1"
Coupling	6.4	6.9	4.1
90° Elbow	13.5	15.5	17.4
Tee - Run	5.9	7.0	6.2
Tee - Branch	12.3	14.9	16.1

Pressure Drop for Zurn PEX Tube – psi/foot								
GPM	3/8"		1/2"		3/4"		1"	
	Pressure Drop	Velocity (ft/sec)	Pressure Drop	Velocity (ft/sec)	Pressure Drop	Velocity (ft/sec)	Pressure Drop	Velocity (ft/sec)
0.5	0.020	1.7	0.004	0.9	0.001	0.5	0.000	0.3
1	0.070	3.3	0.016	1.8	0.003	0.9	0.001	0.5
1.5	0.149	5.0	0.034	2.7	0.006	1.4	0.002	0.8
2	0.254	6.7	0.057	3.6	0.011	1.8	0.003	1.1
2.2	0.303	7.3	0.069	4.0	0.013	2.0	0.004	1.2
2.5	0.384	8.3	0.087	4.5	0.016	2.3	0.005	1.4
3	0.538	10.0	0.122	5.4	0.023	2.7	0.007	1.6
4			0.207	7.2	0.039	3.6	0.011	2.2
5			0.313	9.1	0.058	4.5	0.017	2.7
6			0.439	10.9	0.082	5.4	0.024	3.3
7			0.583	12.7	0.109	6.4	0.032	3.8
8					0.139	7.3	0.041	4.4
9					0.173	8.2	0.051	4.9
10					0.210	9.1	0.062	5.5
11					0.251	10.0	0.074	6.0
12					0.294	10.9	0.087	6.6
13					0.341	11.8	0.101	7.1
14							0.116	7.7
15							0.132	8.2
16							0.148	8.8
17							0.166	9.3
18							0.184	9.9
19							0.204	10.4
20							0.224	11.0
21							0.245	11.5
22							0.267	12.1

## Certification

Zurn PEX installation certification is available for professional plumbing contractors, commercial installation sites, and large construction groups. Please contact your local Zurn representative for more information.

If the participant successfully passes the Certification Test, the instructor is to fill out the Temporary Certification Card, sign and date it, and leave with the participant.

### Temporary Certification Card



Name \_\_\_\_\_

Company \_\_\_\_\_

Date \_\_\_\_\_

Instructor Signature \_\_\_\_\_

## Standards, Listings, and Codes

*The following standards, listings, and codes apply to various components of Zurn PEX Plumbing and Radiant Heating Systems.*

### Standards

---

#### **American Society for Testing and Materials**

- ASTM F876 - Crosslinked Polyethylene (PEX) tubing.
- ASTM F877 - Crosslinked Polyethylene (PEX) tubing and fitting systems.
- ASTM F1807 - Brass insert fittings.
- ASTM F2098 - SSC rings.
- ASTM F2159 - Plastic insert fittings.

#### **CSA International**

- B137.0 - General requirements for thermoplastic pressure piping.
- B 137.5 - Crosslinked Polyethylene (PEX) tubing and fitting systems.

#### **NSF International**

- Standard 14 - Plastic piping system components.
- Standard 61 - Drinking water system components-health effects.

This is to certify that the person named on this card has received instruction and successfully completed an examination on the proper installation of Zurn PEX XL brass, Zurn PEX CR, and QickClamp™ insert and crimp fittings, Zurn crimp tools, Zurn gauges, and Zurn PEX tubing.

## Listings

---

### ***NSF International***

Zurn PEX oxygen barrier and non-barrier tubing, Zurn PEX XL fittings, Zurn PEX CR, QickClamp™, Qicktite® fittings, Zurn PEX supply tubes.

### ***International Association of Plumbing & Mechanical Officials (IAPMO)***

Zurn PEX oxygen barrier and non-barrier tubing, Zurn PEX XL fittings, Zurn PEX supply tubes, Waterflex® water heater connectors.

## Model Codes

---

The following model codes recognize Crosslinked Polyethylene (PEX) tubing for use in hot and cold water distribution systems:

***IPC – International Plumbing Code*** (ICC)

***IRC – International Residential Code*** (ICC)

***National Standard Plumbing Code*** (NAPHCC)

***UPC – Uniform Plumbing Code*** (IAPMO)

***U.S. Department of Housing and Urban Development*** (HUD)

The following model codes recognize Crosslinked Polyethylene (PEX) tubing for use in radiant heating systems:

***UMC – IAPMO Uniform Mechanical Code*** (IAPMO)

***IMC – International Mechanical Code*** (ICC)

**It is the responsibility of the installer to ensure that these products are accepted by local code authorities before installing the product.**

## Certification Test

Test is to be given after material has been reviewed. Test is open note. Participant must answer at least 16 correctly for a passing grade.

- |   |          |       |
|---|----------|-------|
| 1. Zurn PEX has UV protection for up to 6 months; however, it should always be stored under cover and not exposed to direct sunlight.   | 1. True  | False |
| 2. Care should be taken not to scratch or crush Zurn PEX tubing   | 2. True  | False |
| 3. Be sure to protect tube with plastic sleeves when it enters and exits the slab.  | 3. True  | False |
| 4. It's okay to use a pipe support or hanger with sharp edges on Zurn PEX tube.   | 4. True  | False |
| 5. Vertical runs should be supported every other floor.   | 5. True  | False |
| 6. The only type of leak detector that should be used is a diluted solution comprising of 2 oz. per gallon using any of these dishwashing detergents: Ultra Palmolive Original Scent, Joy Dishwashing Detergent, or Great Value(Wal-Mart) Dish Detergent. | 6. True  | False |
| 7. Zurn PEX may be directly connected to an electric water heater.  | 7. True  | False |
| 8. Zurn PEX should not be pulled tight during installation to allow for expansion and contraction of the tubing. In commercial applications, it may be necessary to have an expansion arm or loop.  | 8. True  | False |
| 9. In a fire sprinkler application, I can use Zurn PEX tube and another manufacturer's fitting.   | 9. True  | False |
| 10. Be sure to use #10-1-1/4" coarse threaded screws to mount fire sprinkler adaptors.  | 10. True | False |
| 11. I can install Zurn PEX tube 1/2" - 2" in a plenum if wrapped with 1" thick fiberglass insulation.   | 11. True | False |
| 12. When making a Zurn PEX XL brass or CR polymer insert and crimp connection using a copper ring or stainless steel clamp, the ring must be positioned 1/8" to 3/4" from the shoulder of the fitting.  | 12. True | False |
| 13. When using the Zurn Go/No-Go Gauge, always place the gauge opening on the copper crimp ring at a 90° angle for an accurate check.   | 13. True | False |
| 14. As long as the finished crimp gauges properly, there is no need to adjust the tool.   | 14. True | False |
| 15. You can use the QickClamp tool on the stainless steel clamp and vice versa.   | 15. True | False |
| 16. The ratchet and medium QickClamp tools can crimp 3/8", 1/2", 3/4", and 1" QickClamps.   | 16. True | False |
| 17. QickClamps may be used on XL ONLY.  | 17. True | False |
| 18. Be sure that the tab on the inside of the QickClamp stays on the outside of the tubing.   | 18. True | False |
| 19. The large diameter compact tool can make 1-1/4", 1-1/2", and 2" crimps.   | 19. True | False |
| 20. Oil should be applied to all tool pivots during adjustment to extend the life of the tool.  | 20. True | False |

## Zurn PEX Plumbing and Radiant Heating Systems Fire Protection Systems

### PROFESSIONAL INSTALLATION LIMITED WARRANTY

Subject to the terms and conditions of this Limited Warranty, and relating to Zurn PEX Plumbing and Radiant Heating and Fire Protection Systems, Zurn Pex, Inc. warrants only to the owner of the real property when installed by licensed professional contractors or authorized distributors who purchase and properly install in a potable plumbing system and/or radiant heating system and/or fire protection system its:

1. Zurn PEX Non-Barrier and Performa® Barrier cross-linked polyethylene tubing (PEX) and Zurn PEX CR poly insert fittings, and Zurn PEX XL brass insert fittings, and Zurn PEX copper crimp rings when installed as a system with Zurn PEX Non-Barrier and Barrier cross-linked polyethylene tubing (PEX), for a period of twenty-five (25) years, and
2. Zurn PEX Non-Barrier and Performa Barrier cross-linked polyethylene tubing (PEX) and Zurn PEX CR poly insert fittings, and Zurn PEX XL brass insert fittings, and Zurn PEX QickClamp™ crimp rings when installed as a system with Zurn PEX Non-Barrier and Barrier cross-linked polyethylene tubing (PEX), for a period of twenty-five (25) years, and
3. Zurn PEX Non-Barrier cross-linked polyethylene tubing (PEX) and Zurn Z-Bite™ Fittings when installed as a system with Zurn PEX Non-Barrier cross-linked polyethylene (PEX) tubing, for a period of twenty-five (25) years, and
4. Zurn PEX hyPE-RTube PE-RT tube for a period of twenty-five (25) years, and
5. Zurn PEX Non-Barrier and Performa Barrier cross-linked polyethylene tubing (PEX) and Zurn PEX XL brass insert fittings, and Zurn PEX CR poly insert fittings, and stainless steel clamps when installed as a system with Zurn PEX Non-Barrier and Barrier cross-linked polyethylene tubing (PEX), for a period of fifteen (15) years, and
6. Zurn Z-Bite fittings when installed with copper tube meeting ASTM B88 or CPVC tube meeting ASTM D2846 or PEX tube meeting ASTM F876 from another manufacturer for a period of five (5) years, and
7. Zurn PEX Performa Barrier cross-linked polyethylene tubing (PEX), for a period of thirty (30) years, and
8. Zurn PEX Alumicor® PEX-AL-PEX (cross-linked polyethylene-aluminum-crosslinked- polyethylene) tubing for a period of twenty-five (25) years, and
9. Zurn PEX Non-Barrier and Barrier cross-linked polyethylene tubing (PEX) for a period of twenty-five (25) years, and
10. Zurn PEX XL brass insert, and Zurn PEX CR poly insert fittings when not installed with Zurn PEX Non-Barrier and Barrier cross-

linked polyethylene tubing (PEX) and installed with PEX tubing that meets the ASTM F876 requirements for a period of five (5) years, and

11. QickClamp crimp rings when not installed with Zurn PEX Non-Barrier and Barrier cross-linked polyethylene tubing (PEX) and installed with PEX tubing that meets the ASTM F876 requirements, for a period of five (5) years, and
12. Zurn PEX Alumicor PEX-AL-PEX brass compression fittings when used with another manufacturer's tubing that meets the requirements of ASTM F1281 for a period of ten (10) years, and
13. QickPort® plumbing manifolds, under normal conditions of use, for a period of ten (10) years, and
14. Zurn PEX riser tubes and supplies, if installed properly, for a period of one (1) year from the date of installation, and
15. The associated hardware and accessories, including manifolds, distribution headers, valves, electrical controls, and miscellaneous fittings, for a period of two (2) years from the date of installation, and
16. Zurn PEX Crimp Tools, if properly used under normal conditions, for a period of six (6) months from date of purchase.

In order for this Limited Warranty to apply, the above referenced products must be installed by a licensed professional meeting all applicable code requirements and good plumbing practices.

**FAILURE TO INSTALL ZURN PEX PRODUCTS ACCORDING TO MANUFACTURER'S INSTRUCTIONS WILL VOID ALL APPLICABLE WARRANTIES AND MAY RESULT IN SEVERE WATER DAMAGE.** Under this warranty, you only have a right reimbursement if the alleged failure is determined to be a direct result of the product(s) as covered in this warranty and occurred during the warranty period. This warranty does not apply and you do not have a right of reimbursement if the failure or resulting damage is caused by:

- I. freezing during or after the installation or inadequate freeze protection;
- II. damage due to tear, breaks, or other external damages before, during or after installation;
- III. components not manufactured or sold by Zurn Pex, Inc.;
- IV. exposure to temperatures and pressures beyond the specified range for Zurn PEX products as specified on the product in the Zurn PEX Design Manual and Installation Guide;
- V. any form of corrosion;
- VI. exposure to ultraviolet light;
- VII. damage or wear from abnormal operating conditions, accident, abuse, misuse, or unauthorized alterations or

## Zurn PEX Plumbing and Radiant Heating Systems Fire Protection Systems

### PROFESSIONAL INSTALLATION LIMITED WARRANTY *(continued)*

- repair or damage attributable to water discharged as part of a system's normal operating process;
- VIII. exposure to harmful, unauthorized, or unanticipated chemicals or substances;
  - IX. failure to install, inspect, or test Zurn PEX Fire Protection Systems in accordance with applicable code requirements, Zurn PEX Residential Fire Protection Systems Installation Guide instructions at the time of installation, and accepted industry practices including, but not limited to, NFPA13D.
  - X. malfunction or otherwise improper function of sprinkler(s) installed with a Zurn PEX Fire Protection System, which are not manufactured by Zurn Pex, Inc.

THIS WARRANTY IS IN LIEU OF ALL OTHER WARRANTIES OR OBLIGATIONS, EXPRESS OR IMPLIED, INCLUDING ANY IMPLIED WARRANTY OF MERCHANTABILITY OR FITNESS FOR A PARTICULAR PURPOSE. ZURN PEX DOES NOT GUARANTEE OR IN ANY WAY WARRANT THE INSTALLATION OF ZURN PEX PRODUCTS DUE TO THE WIDE VARIANCE IN INSTALLATION PRACTICES AND OTHER CONDITIONS BEYOND OUR CONTROL. IN NO EVENT SHALL ZURN PEX, INC. BE LIABLE IN TORT OR CONTRACT OR UNDER ANY OTHER LEGAL OR EQUITABLE THEORY OF LAW FOR ANY INCIDENTAL SPECIAL, INDIRECT OR CONSEQUENTIAL DAMAGES.

If you believe that a product fails to meet the above Limited Warranty, you should notify us in writing within 30 days of an alleged failure and prior to expiration of the applicable warranty period set forth above, at the following address:

Zurn Pex, Inc.  
P.O. Box 1031  
Hwy. 11 East Commerce, TX 75428  
Attention: Product Claims

Notification should include a description of the product, the failed part, model number (if available), date of purchase and/or date of installation, and how the product fails to meet the above warranty. Upon receipt of a written claim under this Limited Warranty and evidence/identification of the date of manufacture of product, and after inspection by an authorized Zurn PEX representative and determination of a manufacturing defect, Zurn Pex, Inc. will reimburse the property owner for reasonable repair or replacement charges, to include drywall and painting as well as damages to real property and the premises within which the product is installed, resulting from the failure or leak. At our option, and in our sole discretion, we will either repair or replace the product with a Zurn PEX product of the same or similar type, size, and like quantity. THESE REMEDIES ARE THE EXCLUSIVE REMEDIES FOR BREACH OF WARRANTY. UNDER NO CIRCUMSTANCES WILL ZURN PEX, INC. BE LIABLE FOR ANY OTHER INJURY, LOSS, DAMAGE OR EXPENSE WHETHER DIRECT, INDIRECT, CONSEQUENTIAL, EXEMPLARY OR PUNITIVE; INCLUDING BUT NOT LIMITED TO LOSS OF USE, INCOME, PROFIT, PRODUCTION OR INCREASED COST OF OPERATION, SPOILAGE OR DAMAGE TO MATERIAL, OR CHANGE OUT COSTS. In order to qualify for a labor allowance to repair or replace defective material, you must contact Zurn PEX in advance and receive written authorization for this allowance. Except as specified above, we will not pay any costs (labor or otherwise) associated with removing previously installed product(s), installing replacement product(s) or return of a product. If, as determined by Zurn Pex, Inc. in its sole discretion, that repair or replacement of the product is not commercially practicable, or cannot be completed in a timely manner, we may refund the ultimate purchase price paid for the product upon verification by providing a copy of your purchase order, invoice, receipt, or bill of sale. No action on the part of Zurn Pex, Inc. under this warranty shall be construed as an admission of liability or that the product is not fit for its intended use.



**ZURN PEX®, INC.**

Highway 11 East, Commerce, Texas, U.S.A. 75428

Phone: 855-ONE-ZURN (855-663-9876) • Fax: 903-886-2583

*In Canada:*

**ZURN INDUSTRIES LIMITED**

3544 Nashua Drive, Mississauga, Ontario L4V 1L2, 905-405-8272

1.855.ONE.ZURN  
[www.zurn.com](http://www.zurn.com)

Form No. ZMKTG370-04, Rev. 05/16