

Installation, Operation and Maintenance Manual

One-Piece Manifold Reverse Osmosis System

Model PWRO5MAN

PURE WATER

Important

Please read the entire manual before proceeding with the installation and startup. Your failure to follow any attached instructions or operating parameters may lead to the product's failure.

Save manual for future reference.



PWRO5MAN

Table of Contents

Operational Parameters	3
Contents of Reverse Osmosis System	3
Tools Recommended For Installation	3
Drill a Hole for the Faucet in a Porcelain Sink	3
Punch a Hole for the Faucet in a Stainless Steel Sink	3
How to use Quick-Connect Fittings	4
Watts Chrome Top Mount Faucet Installation	5
Adapt-A-Valve™ Installation	5
Drain Saddle Installation	6
Green Tube Connection	6
Reverse Osmosis Module Mounting	6
Red Tube Connection	6
Check Air Pressure in the Tank	7
Tank Elbow Installation	7
Blue Tube Connection	7
Blue Tube to Faucet Connection	7
Final Filter Installation	8
Startup Instructions	8
6-Month Maintenance	9
Annual Maintenance	9
Membrane Replacement	10
Procedure for Extended Non-Use	10
Troubleshooting	11
Arsenic Facts	12
Parts List	13
Service Record	14
Limited Warranty	16



System tested and certified by NSF International against NSF/ANSI Standard 58 for the reduction of the claims specified on the performance data sheet.

Note: Do not use with water that is microbiologically unsafe or of unknown quality without adequate disinfection before or after the system. Systems certified for cyst reduction may be used on disinfected waters that may contain filterable cysts.

Introduction

Thank you for your purchase of a state-of-the-art Watts Reverse Osmosis (RO) water treatment system. Water quality concerns are quickly becoming more of a focus for the public. Lately you may have heard about contaminants in the drinking water, such as arsenic, chromium, cryptosporidium or Giardia. There may also be some local water issues in your area such as high levels of lead and copper. This Watts water treatment system has been designed and tested to provide you with high-quality water for years to come. The following is a brief overview of the system.

Your Reverse Osmosis System:

Osmosis is the process of water passing through a semi-permeable membrane in order to balance the concentration of contaminants on each side of the membrane. A semi-permeable membrane is a barrier that will pass some particles like clean water, but not other particles like arsenic and lead.

Reverse osmosis uses a semi-permeable membrane, however, by applying pressure across the membrane, it concentrates contaminants (like a strainer) on one side of the membrane, producing crystal clear water on the other. This is why RO systems produce both clean drinking water and waste water that is flushed from the system. This reverse osmosis system also utilizes carbon block filtration technology and can, therefore, provide a higher quality drinking water than carbon filtration systems alone.

Your system is a 5-stage RO which is based upon five separate treatment segments within the one complete water filtration system. These stages are as follows:

Stage 1 – Sediment Filter, recommended change 6 months. (See Page 9).

The first stage of your RO system is a 5-micron Sediment Filter that traps sediment and other particulate matter like dirt, silt and rust which affect the taste and appearance of your water.

Stage 2 – Carbon Filters, recommended change 6 months. and 3 (See Page 9).

The second and third stages each contain a 5-micron Carbon Block Filter. This helps ensure that chlorine and other materials that cause bad taste and odor are greatly reduced.

Stage 4 - Membrane, recommended change 2-5 years.

Stage 4 is the heart of the reverse osmosis system, the RO Membrane. This semi-permeable membrane will effectively take out TDS, sodium and heavy metals such as arsenic, copper, and lead, as well as cysts, such as giardia and cryptosporidium. Because the process of making this high-quality drinking water takes time, your RO water treatment system is equipped with a storage tank.

Stage 5 - Carbon In-line Filter, recommend change 6 - 12 months.

The final stage is an Inline Granular Activated Carbon (GAC) Filter. This filter is used after the water storage tank and is used as a final polishing filter.

System Maintenance

Just because you cannot taste it, does not mean that it is not there. Contaminants such as lead, chromium and arsenic (to name a few) are undetectable to the taste. Additionally, over time if you do not replace the filter element, other bad tastes and odors will be apparent in your drinking water.

This is why it is important to change out your filter at the recommended intervals as indicated in this system manual. When replacing the filter elements, pay special attention to any cleaning instructions. Should you have any further questions please refer to our website at www.watts.com or call our customer service department at **1-800-244-1299**.

With proper installation and maintenance, this system will provide you with high-quality water for years to come. All of Watts water enhancement products are rigorously tested by independent laboratories for safety and reliability. If you have any questions or concerns, please contact our Customer Service department at 1-800-244-1299 or refer to our on-line troubleshooting at www.watts.com.

Replacement Filter Packs

MODEL	FREQUENCY	DESCRIPTION
PWFPK3MAN	6 Months	Includes sediment and carbon filters only
PWFPK5MAN	Annual	Includes all filters and membrane
PWMEM50	2 - 5 years	50 gallon per day membrane
PWFILGAC10	Annually	10" final in-line filter

Note: Water conditions may require more frequent cartridge replacement

Operational Parameters

Do not use with water that is microbiologically unsafe or of unknown quality without adequate disinfection before or after the system. System is intended to be installed on the cold water line only.

Operating Temperatures	Maximum 100°F (38°C)	Minimum 40°F (4°C)
Operating Pressure	Maximum 85psi (6.0 kg/cm ²)	Minimum 40psi (2.80 kg/cm ²)
pH Parameters	Maximum 11	Minimum 2
Iron	Maximum 0.2 ppm	
TDS (Total Dissolved Solids)	< 1800 ppm	
Turbidity	< 5NTU	

Hardness: Recommended hardness not to exceed 10 grains per gallon, or 170ppm. System will operate with hardness over 10 grains but the membrane life may be shortened. Addition of a water softener may lengthen the membrane life.

Water Pressure: The operating water pressure in your home should be tested over a 24-hour period to attain the maximum pressure. If the incoming water pressure is above 85psi, a pressure regulator is recommended and if over 100psi, then a pressure regulator is required.

Copper Tubing: Reverse Osmosis water should not be run through copper tubing as the purity of the water will leach copper causing an objectional taste in water and pin holes may form in the tubing. Watts supplies speciality filters that can be used if copper tubing follows the Reverse Osmosis unit. Be sure to follow any state, province or local regulations during installation.

Contents of Reverse Osmosis (RO) System

- 1 Tank – Blue or White
- 1 RO Module
- 1 Parts Bag – With a 10" Final Filter
- 1 Faucet Bag
- 1 Manual

If any of the items are missing please contact prior to installing.

Tools Recommended for Installation

- 1¼" Hole Saw Bit for Faucet opening
- Round Knockout Punch for Stainless Sinks 1¼"
- Adjustable Wrench
- Sharp Knife
- ½" & ⅝" Open End Wrenches
- Phillips Screw Driver
- Needle Nose Pliers – Adjustable Pliers
- Electric Drill
- ⅛" Drill Bit
- ¼" Drill Bit
- ⅜" Drill Bit



STEP 1

Drill a Hole for the Faucet in a Porcelain Sink

Note: Most sinks are predrilled with ½" or 1¼" diameter hole that you can use for your RO faucet. (If you are already using it for a sprayer or soap dispenser, see Step 2).

Caution: Porcelain sinks are extremely hard and can crack or chip easily.

Use extreme caution when drilling. Watts accepts no responsibility for damage resulting from the installation of faucet.

Step A – Determine desired location for the RO faucet on your sink and place a piece of masking tape over where the hole is to be drilled. Mark the center of the hole on the tape.

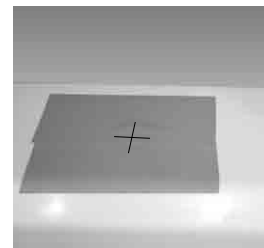

Step B – Using a variable speed drill set on the slowest speed, drill a ⅛" pilot hole through both porcelain and metal casing of sink at the marked center of the desired location. Use lubricating oil or liquid soap to keep the drill bit cool (If drill bit gets hot, it may cause the porcelain to crack or chip).



Step C – Using a 1¼" hole saw, proceed to drill the large hole. Keep drill speed on the slowest speed and use lubricating oil or liquid soap to keep the hole saw cool during cutting.

Step D – Make sure the surroundings of the sink are cooled before mounting the faucet to the sink after drilling and remove all sharp edges.

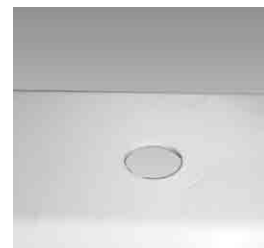

OR

Punch a Hole for the Faucet in a Stainless Steel Sink

Note: If mounting faucet to a Stainless Steel Sink, you will need a 1¼" Hole Punch. The faucet opening should be centered between the backsplash and the edge of the sink, ideally on the same side as the vertical drain pipe.

Step A – Drill a ¼" pilot hole. Use a ½" Hole Punch and an adjustable wrench to punch the hole in the sink. Change to the 1¼" Hole Punch to enlarge the hole.



The faucet can now be installed.

How to Use the Quick-Connect Fittings on the RO Module

To make a connection, the tube is simply pushed into the fitting. Place a piece of tape 1/2" from end of tube to indicate how far the tube should be inserted. The unique Quick-Connect locking system

holds the tube firmly in place without deforming it or restricting flow.

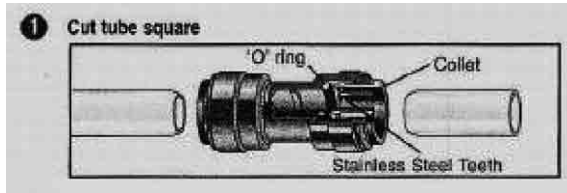

Cut the tube square. It is essential that the outside diameter be free of score marks and that burrs and sharp edges be removed before inserting into fitting.

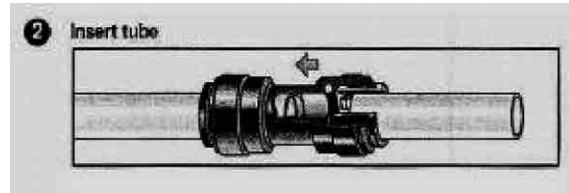

Fitting grips before it seals. Ensure tube is pushed into the tube stop.

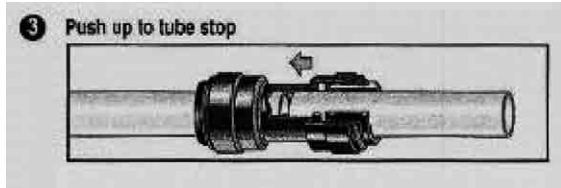

Push the tube into the fitting, to the tube stop. The collet (gripper) has stainless steel teeth which hold the tube firmly in position while the O-ring provides a permanent leak proof seal.

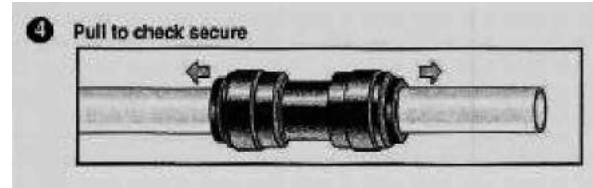

Pull on the tube to check that it is secure. It is a good practice to test the system prior to leaving site and /or before use.

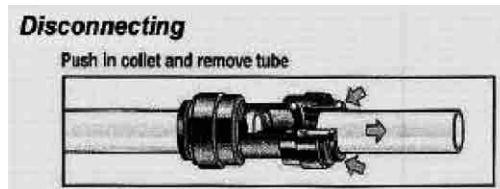

To disconnect, ensure the system is depressurized before removing the tube. Push in collet squarely against face of fitting. With the collet held in this position, the tube can be removed. The fitting can then be reused.

STEP 2

Watts Chrome Top Mount Faucet Installation

	MINIMUM	MAXIMUM
Mounting Hole Size	1"	1¼"
Torque on Toggle Bolt	5 lb.in. (max)	

Gather and identify the faucet pieces.

Step A - Remove faucet base and faucet spout from their respective plastic bags. From above the sink, feed the faucet tubing and toggle bolt down through the 1¼" mounting hole in the sink. Ensure that the soft rubber gasket is uniformly positioned in between the base of the faucet and the top of the sink.

Step B - Align the faucet base so that the handle is on the right side and the base is sitting flush on the sink top. Turn the handle down (towards you) to the "ON" position to reveal the tightening screw (located where the spout will be inserted). Using a phillips head screwdriver, turn the screw clockwise until the toggle bolt secures the faucet base snug onto the sink top.

Step C - Once the faucet base is securely fastened to the sink top, insert the faucet spout into the faucet base until it is fully seated. Turn the handle up (away from you) to the "OFF" position.

Step D - Locate ¾" blue tubing in parts bag, connect open end of the ¾" tubing to the quick-connect fitting located on the faucet shank.

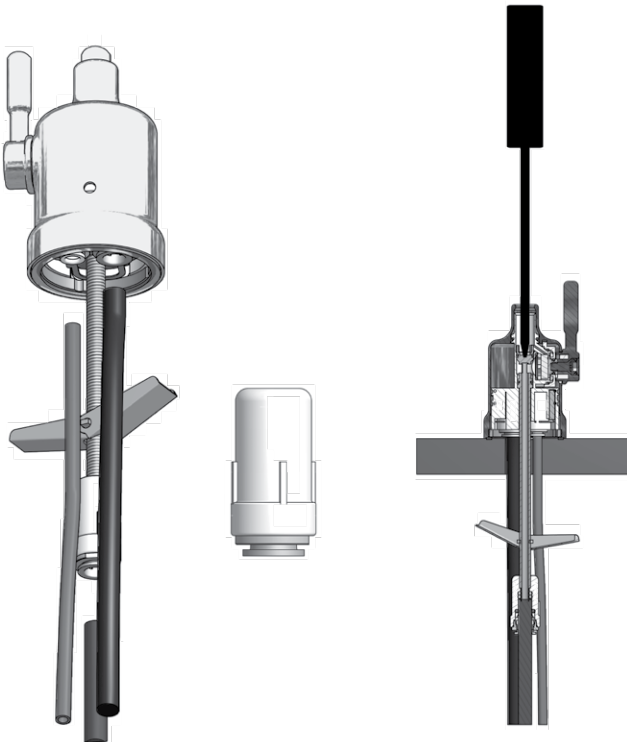

STEP 3

Adapt-A-Valve™ Installation

Verify contents prior to installation:

- (1) - Plastic Adapt-a-Valve™ & Black Collet
- (1) - Brass Adapter no washer
- (1) - Brass Adapter with black washer
- (1) - White rubber washer

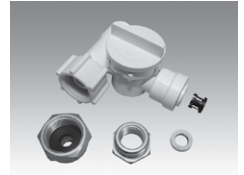

Water supply line to the system must be from the cold water supply line only. Hot water will severely damage your system.

WARNING: Do not use Teflon tape with the Adapt-A-Valve™.

For ¾" Configuration

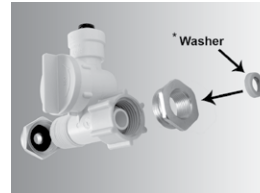

(With Brass Fittings)
* Insert White Washer



Hot
Supply

Cold
Supply

For ½" Configuration

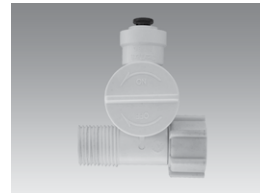

(Without Brass Fittings)
½" Configuration

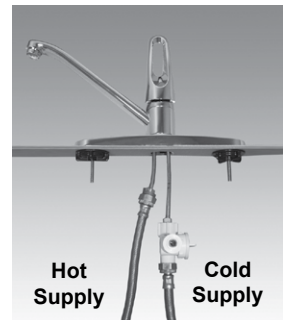

Hot
Supply

Cold
Supply

Step A - Turn off the cold water supply to the faucet by turning the angle stop valve completely off.

Step B - Open cold water sink faucet to relieve pressure.

Step C - Choosing the configuration that fits your plumbing, attach the Adapt-A-Valve™ as illustrated in the four photos above.

STEP 4

Drain Saddle Installation - Fits standard 1 1/4" – 1 1/2" drain pipes

Follow all local plumbing codes for your installation.

Caution: If you have a garbage disposal, do not install the drain saddle near it. Installation of the drain saddle must be either above the garbage disposal, or if a second sink drain is available, install it above the cross bar on the second drain. Installation of the drain saddle near a garbage disposal may cause the drain line to plug.

Step A – Locate the drain saddle kit in the parts bag.

Gather the pieces of the drain saddle

- (1) - Black compression nut
- (1) - Semicircle bracket with opening
- (2) - Screws
- (1) - Foam gasket
- (2) - Nuts for screws
- (1) - Semicircle bracket

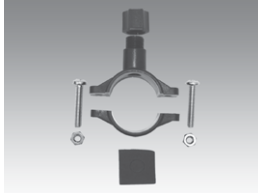

Step B – The small square black foam gasket with a circle cut out of the middle must be applied to the inside of the drain saddle. Remove sticky tape backing and stick to the drain saddle as shown.

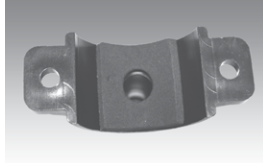
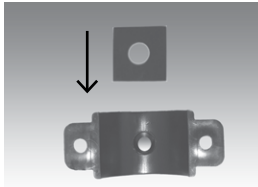

Step C – The drain saddle must be installed at least 1 1/2" above the nut of the P-Trap elbow or cross bar from the garbage disposal to insure proper drainage. Using the 1/4" drill bit, drill into the drain pipe at best available location as specified above, for drain saddle installation. Take extreme caution to only drill through one side of the drain pipe.

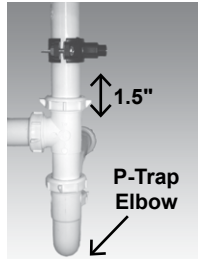

Step D – Assemble the drain saddle around the drain pipe and align drain saddle fitting opening with the hole drilled in the previous step - you may use a small screwdriver to feed through the drain saddle into the drain pipe to aid with the alignment. Using a Phillips screw driver tighten the drain saddle bolts evenly and securely on both sides.

Caution: Do not over tighten the screws. It may crack the drain saddle.

Drain Saddle Tube Connection

The black 3/8" drain tube must be as SHORT and STRAIGHT as possible to the drain saddle, making a downward slope from faucet to drain saddle to allow for proper drainage. This is a gravity fed line and if there is any bend or dip in the tube, the rinse water will not flow into the drain properly. Water may back up and come out the air gap hole in the back of the faucet.

Step A – Measure the 3/8" drain tube from faucet to the drain saddle on the drain pipe and make a straight cut to the correct length.

Step B – Slip drain tube through black compression nut. Insert drain tube into the opening in the drain saddle and hand tighten the black nut, and add 1/4 turn with a wrench.



STEP 5

Green Tube Connection

Step A – Locate green tube attached to the RO Module. Insert the open end of the green 1/4" tube into the open 1/4" Quick-Connect fitting on the Adapt-A-Valve™ making sure the tube is pushed in all the way to the tube stop.



Step B – Connect the green tube from the RO module to the Adapt-A-Valve™ that is connected to the angle stop valve. Leave enough tube so it is not kinked and cut the tube to the desired length.

STEP 6

Reverse Osmosis Module Mounting

Step A – Determine best location for the RO module to be mounted to allow for future system maintenance. The parts bag has 2 self-tapping screws. Using an electric drill with a Phillips bit, screw them into the cabinet wall 6" apart and 16" from the bottom of the cabinet.

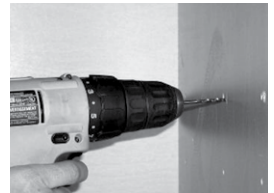

Note: Do not cut any RO system tubes at this time.

STEP 7

Connect the Red Tube from Faucet to RO Module

Step A – Insert the red 1/4" tube from the faucet into the port on the module marked DRAIN. Make sure the tube is pushed in all the way to the tube stop.



STEP 8

Check Air Pressure in the Tank

Note: Check air pressure when tank is empty of water!

Check air pressure in the storage tank when you notice a decrease in available water from the RO system. Air can be added with a bicycle pump using the schrader valve that is located on the lower side of the tank behind the blue plastic cap.

Step A – Turn off the incoming water supply to the RO by turning the knob on the Adapt-A-Valve™ clockwise until it stops. (Follow the green tube away from the RO system to find the Adapt-A-Valve™).



Step B – Open the RO Faucet and allow water to drain from the tank until it is completely empty.

Tip: When water from the RO faucet slows to a trickle with the faucet still in the open position, you may add air to the tank to purge any left over water. This will ensure that the tank is completely empty.

Step C – Once all water in the tank is purged, check air pressure using an air pressure gauge. It should read between 5 - 7psi. (Digital air pressure gauge is recommended)

Step D – Follow Startup Instructions on Page 8.

STEP 9

Tank Valve Installation - Plastic Tank

Step A – Make sure the O-ring is located at the bottom of the recess for the tank connection.

Step B – Thread the plastic valve onto the tank fitting. **Do not over-tighten or the valve could crack. Do not use Teflon® tape.**

STEP 10

Connect Blue Tube from RO Module to the Tank

Step A – Position tank in desired location. Stand it upright or lay it on its side (using the black plastic stand). Measure the blue tube from the RO module port marked TANK over to the tank and cut it to desired length.



Step B – Insert the 3/8" blue tube into the Ball Valve quick-connect fitting making sure that the tube is pushed in all the way to the tube stop.



STEP 11

Connect Blue Tube from Faucet to RO Module

Step A – Locate the 3/8" blue tube connected to the RO faucet.

Step B – Insert the 3/8" blue tube attached to the faucet into the RO model port labeled faucet. Make sure that the tube is pushed in all the way to the tube stop.

STEP 12

Final Filter Installation

Step A – Remove the caps from the final filter.



Step B – Thread the 3/8" grey plastic quick-connect fittings into each end of the Final Filter and tighten.



Step C – Cut the blue tubing between the RO faucet and the RO module at a desired location to splice in the in-line final filter.

Step D – With the directional flow arrow on the final filter pointing towards the faucet, insert the blue tubing from the RO faucet into the fitting on the final filter. Repeat this step to connect the blue tubing from the RO module into the inlet side of the final filter.



Startup Instructions

Step A– Turn on the incoming cold water at the angle stop valve. Turn the knob on the Adapt-A-Valve™ by turning counterclockwise. Check the system for leaks, and tighten any fittings as necessary. (Check frequently over the next 24 hours to ensure no leaks are present).

Note: If you have connected your RO system to a refrigerator / ice maker, make sure the ice maker is off (do not allow water to flow to the ice maker) until flushing is complete and the tank has been allowed to fill completely. Connection from the RO to the ice maker system should have an inline valve installed before the ice maker so it can easily be closed to prevent water flowing to the ice maker during startup and periodic maintenance. Your RO tank must be allowed to fill up fully in order for the ice maker system to work properly.

Step B – Open the RO faucet and leave it open until water begins to trickle out. (It will come out slowly).

Step C – After water trickles out of the faucet, close the RO faucet allowing the storage tank to fill with water. It may take 4 to 6 hours to fill the tank completely depending on the production capability of the membrane, local water temperature and water pressure.

Note: During the fill period, you may hear water trickling due to the Reverse Osmosis Process.

Step D – After the Tank has filled, open the RO Faucet to flush the tank completely to remove carbon particles from final filter. You will know that the tank is empty when the flow rate from the RO faucet is down to a trickle. Repeat this step two more times. The fourth tank can be used for drinking.

Note: Flushing of the tank three times is only necessary during the initial startup and after replacing the membrane.

Important: Your reverse osmosis system contains replaceable treatment components that are critical for effective containment reduction. Periodic inspection and following proper system maintenance is critical for continued performance.

6-Month System Maintenance

Order filter by calling Watts at 1-800-224-1299

Item Needed: EDP# 7100113

Includes:

- (1) Sediment Filter
- (2) Carbon Block Filters

Step A – Turn off the incoming water supply to the RO by turning the knob on the Adapt-A-Valve™ clockwise until it stops.

Step B – Open the RO Faucet and allow water to drain from the tank until it is completely empty.

Note: Water may be saved in a container for drinking or to rinse system parts.

Step C – Let system sit for 10 to 15 minutes after the tank is empty to let the system depressurize before attempting to remove filter housings.

Step D – For more leverage you may leave the RO module attached to wall of cabinet. If you are unable to access the module while it is mounted, remove it prior to changing filters. Starting with the closest housing (Stage 1), remove it by turning it clockwise (left), empty water, then discard filter. Continue on to the 2nd housing (Stage 2) and 3rd housing (Stage 3).

Step E – Clean the filter housings (bowls) with a mild soap solution and rinse with water. Check O-rings and lubricate with water soluble lubricant. KY Jelly®, canola oil or other water based lubricants may be used. **Petroleum based lubricants (such as Vaseline®) must not be used.**



Caution: Before re-installing the filter bowls back on to the system, check O-rings to make sure they are still in place.

Do not over-tighten filter housing. May damage O-ring(s), cause water leaks, or affect system performance.

Step F – Insert a new Sediment Filter (cloth like appearance) into the 1st filter housing which is the one on the water inlet side (green tubing from the Adapt-A-Valve™) of the RO system and re-install housing.

Step G – Insert the new Carbon Block filter (White end caps & plastic netting) into the second and third filter bowls and re-install housings.

Do not over-tighten filter housing, overtightening may damage O-ring(s), cause water leaks, or affect system performance.

Step H – Turn water supply on to the unit by turning the knob on the Adapt-A-Valve™ counterclockwise.

Step I – Open the RO faucet and leave it open until water begins to trickle out (it will come out slowly).

Step J – Close the RO faucet allowing the storage tank to fill with water. It may take 4 to 6 hours to fill the tank completely depending on the production capability of the membrane, local water temperature and water pressure.



Annual Maintenance

Order filter by calling Watts at 1-800-224-1299

Item Needed: EDP# 7100114

1/2 cup of hydrogen peroxide or household bleach.

Includes:

- (1) Sediment Filter
- (1) Membrane
- (2) Carbon Block Filters
- (1) Final Inline Filter

Note: Sanitizing of unit is recommended.

Step A – Perform Steps A through E in the 6-Month System Maintenance.

Note: If not sanitizing the system skip to Step H.

Step B – Remove the RO membrane from its housing and rest in a clean sanitary place. (Refer to “Membrane Replacement” section on Page 10 for directions on removing the membrane). Replace cap onto empty membrane housing and re-connect green tubing.

Step C – Leaving the filters out, replace Stage 1 and 2 empty filter housings (hand tight) onto unit. Measure & pour either ½ cup of hydrogen peroxide or common household bleach into the 1st Filter housing (Stage 1) and hand tighten onto unit.

Step D – With the RO faucet in the closed position turn on the incoming water supply to the system by turning the Adapt-A-Valve™ counterclockwise. Wait 1 minute for the unit to pressurize. Turn on the RO faucet and let the water run for 30 seconds. Turn off the RO faucet and let the unit rest for 2 minutes. Finally, open the RO faucet and let the water run for 5 more minutes.

Step E – Turn off the incoming water supply to the system by turning the Adapt-A-Valve™ clockwise until it stops. Keep the RO faucet open until the storage tank is completely drained.

Step F – Open the membrane housing and re-install the RO membrane while making sure not to kink the O-rings. (Refer to “Membrane Replacement” section on Page 10 for directions on installing the membrane). Tighten the cap back on the housing and reconnect green tubing.

Step G – Remove filter housings Stage 1 and 2 and empty of water.

Caution: Before re-installing the filter bowls back on to the system, check O-rings to make sure they are still in place and lubricate with water soluble lubricant.

Do not over-tighten filter housing. May damage O-ring(s), cause water leaks, or affect system performance.

Step H – Insert the new Sediment Filter (cloth like appearance) into the 1st filter housing which is the one on the water inlet side (green tubing from the Adapt-A-Valve™) of the RO system and re-install housing.

Step I – Insert the new Carbon Block filters (White End Caps) into the 2nd housing and 3rd housing, then re-install housings.

Step J – The Final In-line Filter is located on the blue tube between the storage tank and the RO faucet. Remove it by loosening the compression fittings on both ends of the filter and replace with new filter. (Discard used final filter after sanitizing).

Note: The arrow on the final filter must be pointing towards the RO faucet / away from the RO storage tank.

This is a good time to check the air pressure in your storage tank. For instructions please see Page 7.

Step K – Follow Steps H through J in the 6-Month System Maintenance (Page 9) for startup directions.

Membrane Replacement

This reverse osmosis system contains a replaceable component (the RO membrane) which is critical to the efficiency of the system.

Replacement of this reverse osmosis membrane should be with one of identical specifications as defined by Watts to assure the same efficiency and contaminant reduction performance.

Membranes have a life expectancy between 2 and 5 years, depending on the incoming water conditions and the amount the RO system is used. This reverse osmosis membrane is critical for effective reduction of total dissolved solids (TDS). The product water should be tested periodically to verify that the system is performing satisfactorily.

Normally, a membrane would be replaced during a semiannual or annual filter change. However, if at any time, you notice a reduction in water production or an unpleasant taste in the reverse osmosis water, it could be time to replace the membrane. Watts recommends replacing the membrane when TDS reduction falls below 75%.

Note: A water sample may be sent to Watts for a free diagnosis of your membrane performance. To send a water sample, use two (2) clean containers and fill ½ cup of tap water in one container and ½ cup of reverse osmosis water in 2nd container. Clearly label each sample. Send the samples to the address listed on the cover of this manual attention "Water Samples". Watts will test the water and mail or call you with the results.

Step A – Turn off the incoming water supply to the RO by turning the knob on the Adapt-A-Valve™ clockwise until it stops.

Step B – Open the RO Faucet and allow water to drain from the tank until it is completely empty.



Removing the Membrane

Step A – Use a 5/8" wrench to remove the Green Tube fitting on the left side of the horizontal membrane housing (end with one elbow).

Step B – Remove the cap from the Membrane Housing by turning it counterclockwise to loosen.

Note: A double sided wrench may be purchased from Watts to aid with loosening the cap / filter housings.

Step C – Remove membrane housing from the holding clips. Using a pair of pliers, grip the PVC tube of the RO membrane and pull firmly on the membrane to remove from the housing and discard.



Installing the Membrane

Step A – Lubricate the O-rings on the new membrane with a water soluble lubricant such as KY Jelly ®. Insert the end with the two black O-rings first into the housing.

Step B – Once membrane has been inserted into the housing, you must take your thumbs and give a firm push to properly seat the membrane. Replace membrane housing cap and tighten.

Step C – After replacing membrane housing into clips, attach the green tube to the elbow on cap using 5/8" wrench.

Step D – Follow the Start Up Instructions on Page 8.

Procedure for Extended Non-Use

(More than 2 months)

Turn off the water supply by turning the knob on the Adapt-A-Valve™ clockwise until it stops and open the RO faucet to empty the storage tank. (Save a few ounces of RO water). Once the storage tank is empty, remove the membrane and place it in a sealed plastic bag with the RO water saved earlier and store in your refrigerator.

For restart, reinstall membrane (See Page 10 for membrane installation procedure) and follow Startup Instructions on Page 8.

Troubleshooting

PROBLEM	CAUSE	SOLUTION
Low/Slow production	Low water pressure Crimps in tubing Clogged pre-filters Fouled membrane	Assure a minimum of 40psi incoming water pressure. Watts sells a booster pump if home water pressure is low. Make sure water supply is turned on and Adapt-A-Valve™ is all the way open. Check tubing and straighten or replace as necessary. Replace pre-filters. Replace membrane and clean flow restrictor.
Milky colored water	Air in system	Air in the system is a normal occurrence with initial start up of the RO system. This milky look will disappear during normal use within 1-2 weeks. If condition reoccurs after filter change, drain tank 1 to 2 times.
Water constantly running unit will not shut off	Low water pressure Fouled membrane High water pressure High air pressure in tank	See #1 above. Replace membrane. Check incoming water pressure to make sure it does not exceed 100psi. A pressure relief valve may be necessary. Empty storage tank of water. Set tank air pressure to 5psi. See previous page.
Noise from faucet or drain	Air gap faucet Location of drain saddle Higher capacity membrane High water pressure	Inherent sound with air-gap faucets. See diagram for proper location of drain saddle. Normal with high-capacity membrane Check incoming water pressure to make sure it does not exceed 100psi. A pressure relief valve may be necessary.
Faucet leaks from the air gap feature	Crimp or loop in drain line Drain tube clogged/restricted	Straighten black 3/8" drain tube. Cut off any excess tubing caused from dishwasher or garbage disposal. Disconnect the 3/8" black tube at the drain, clean the 3/8" black tube out with a wire, then reconnect.
Small amount of water in storage tank	System just starting up Low water pressure Too much air in tank	Normally it takes 6-10 hours to fill tank. Note: Low pressure and/or temperature can drastically reduce production rate. See #1 Above Add air if below 5psi and bleed if above 5psi. Check only when tank is empty of water. See previous page.
Water leaks from the filter housing	Not properly tightened. Missing or kinked O-ring	Tighten the bowl. Turn off the water supply. Release the pressure, remove bowl and replace the O-ring. Make sure the O-ring is seated in the filter bowl properly before reinstalling the filter bowl.

Arsenic Facts

Arsenic (As) is a naturally occurring contaminant found in many ground waters. Arsenic in water has no color, taste or odor. It must be measured by an arsenic test kit or lab test.

Public water utilities must have their water tested for arsenic. You can obtain the results from your water utility contained with in your consumer confidence report. If you have your own well, you will need to have the water evaluated. The local health department or the state environmental health agency can provide a list of test kits or certified labs.

There are two forms of arsenic: pentavalent arsenic (also called As (V), As (+5)) and trivalent arsenic (also called As (III), As (+3)). In well water, arsenic may be pentavalent, trivalent, or a combination of both. Although both forms of arsenic are potentially hazardous to your health, trivalent arsenic is considered more harmful than pentavalent arsenic.

RO systems are very effective at removing pentavalent arsenic. A free chlorine residual will rapidly convert trivalent arsenic to pentavalent arsenic. Other water treatment chemicals such as ozone and potassium permanganate will also change trivalent arsenic to pentavalent arsenic. A combined chlorine residual (also called chloramine) where it does convert trivalent arsenic to pentavalent arsenic, may not convert all the trivalent arsenic in to pentavalent arsenic. If you get your water from a public water utility, contact the utility to find out if free chlorine or combined chlorine is used in the water system.

This Watts reverse osmosis system is designed to remove up to 98% of pentavalent arsenic. It will not convert trivalent arsenic to pentavalent arsenic. Under laboratory standard testing conditions, this system reduced 0.30 mg/L (ppm) pentavalent arsenic to under 0.010 mg/L (ppm) (the USEPA standard for drinking water). Actual performance of the system may vary depending on specific water quality conditions at the consumer's installation. In addition to the independent laboratory standard testing conditions Watts has conducted additional field testing on our reverse osmosis units to determine trivalent arsenic reduction capabilities. Based upon Watts field testing, it has been determined that the RO units are capable of reducing up to 67% of trivalent arsenic from the drinking water.

The RO membrane component of this Watts reverse osmosis system must be maintained according to its recommended maintenance cycle. Specific component identification and ordering information can be found in the installation/operation manual maintenance section, by phone at 1-800-224-1299 or online www.watts.com

Parts List

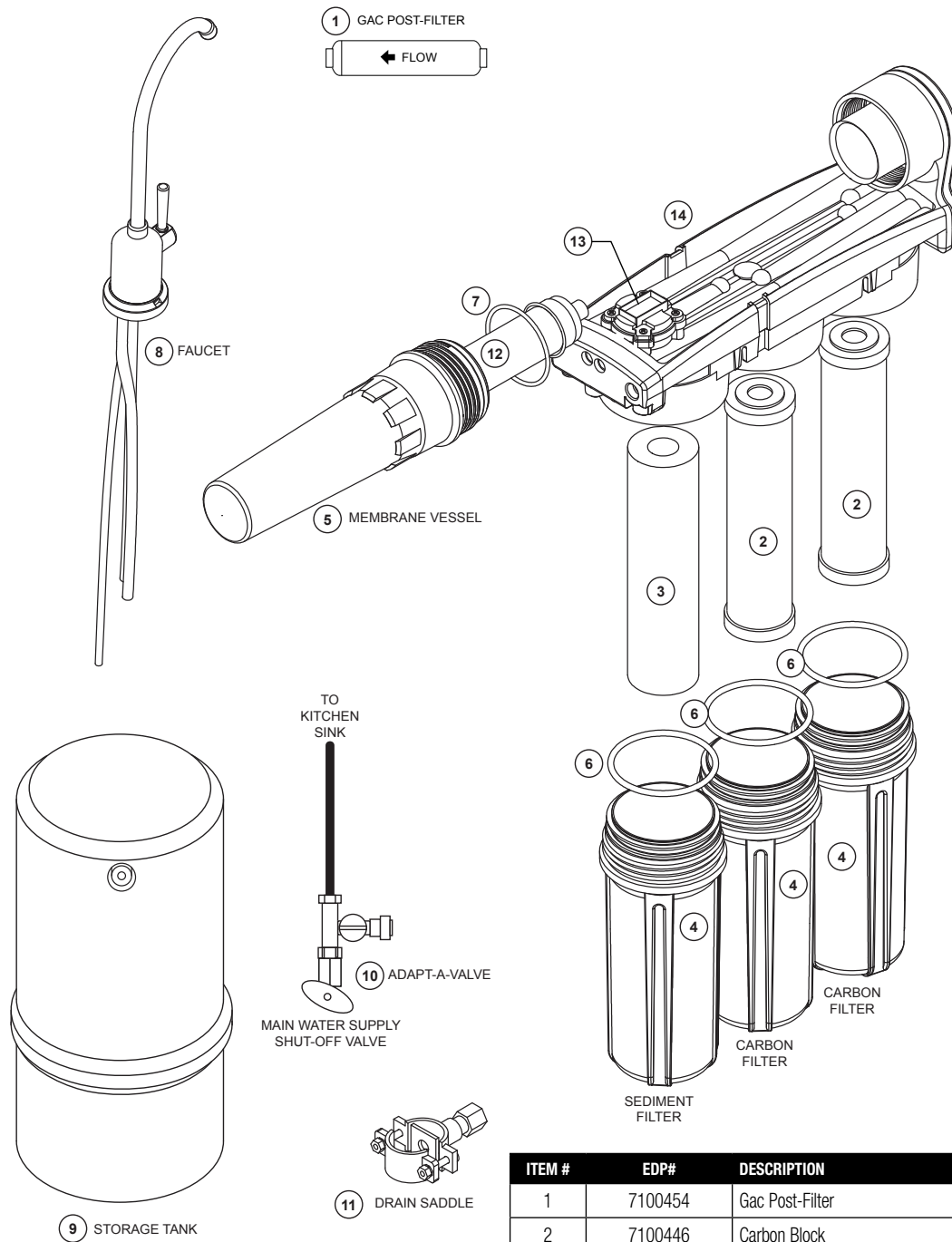

ITEM #	EDP#	DESCRIPTION
1	7100454	Gac Post-Filter
2	7100446	Carbon Block
3	7100331	Sediment Filter
4	7300043	Manifold Bowl
5	7300046	Manifold Membrane Vessel
6	7300058	O-Ring For Manifold Bowl
7	7300057	O-Ring For Membrane Vessel
8	7100203	Airgap Faucet - Chrome
9	7100173	Storage Tank - Plastic - 3 Gal White
10	7300068	Adapt-A-Valve™
11	7300030	Drain Saddle - 3/8"
12	7100122	Reverse Osmosis Membrane
13	7300074	Tank Shut-Off Valve (Not Shown)
14	7300022	Flow Restrictor (Not Shown)

CALIFORNIA PROPOSITION 65 WARNING

WARNING: This product contains chemicals known to the State of California to cause cancer and birth defects or other reproductive harm. (California law requires this warning to be given to customers in the State of California.)

For more information: www.watts.com/prop65

LIMITED WARRANTY: Certain Watts Pure Water products come with a limited warranty from Watts Regulator Co. Other products may have no warranty or are covered by the original manufacturer's warranty only. For specific product warranty information, please visit www.watts.com or the published literature that comes with your product. Any remedies stated in such warranties are exclusive and are the only remedies for breach of warranty. **EXCEPT FOR THE APPLICABLE PRODUCT WARRANTY, IF ANY, WATTS MAKES NO OTHER WARRANTIES, EXPRESS OR IMPLIED. TO THE FULLEST EXTENT PERMITTED BY APPLICABLE LAW, WATTS HEREBY SPECIFICALLY DISCLAIMS ALL OTHER WARRANTIES, EXPRESS OR IMPLIED, INCLUDING BUT NOT LIMITED TO THE IMPLIED WARRANTIES OF MERCHANTABILITY AND FITNESS FOR A PARTICULAR PURPOSE, AND IN NO EVENT SHALL WATTS BE LIABLE, IN CONTRACT, TORT, STRICT LIABILITY OR UNDER ANY OTHER LEGAL THEORY, FOR INCIDENTAL, INDIRECT, SPECIAL OR CONSEQUENTIAL DAMAGES, INCLUDING, WITHOUT LIMITATION, LOST PROFITS OR PROPERTY DAMAGE, REGARDLESS OF WHETHER IT WAS INFORMED ABOUT THE POSSIBILITY OF SUCH DAMAGES.**



A Watts Water Technologies Company

USA: Tel. (800) 224-1299 • www.watts.com

Canada: Tel. (888) 208-8927 • www.watts.ca