

"Apollo" POWERPRESS

# INSTALLATION MANUAL



### WARNING

It is the responsibility of the end-user to follow all instructions for installing Apollo® POWERPRESS fittings and valves. Failure to follow these instructions and safe plumbing practices may result in extensive property damage, serious injury or death.

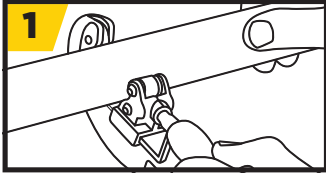

### CUT PIPE TO LENGTH

After measuring, the pipes can be cut to length using a pipe cutter, a fine-toothed handsaw or an electrical mechanical saw suitable for the pipe material. The pipe must always be cut completely through. Never partially cut the pipe and break it off as this could cause leakage. When cutting already installed pipes, always take into account a minimum distance to weldings and bends of 4" for pipe sizes 1/2"– 1-1/4", and 3x outside diameter for pipe sizes 1-1/2"– 2".

**Do not use oil-cooled saws, grinding wheels or flame cutters.**

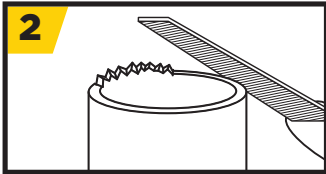

### DEBURR PIPE

Pipe ends must be carefully and thoroughly deburred in and outside after being cut to length in order to avoid damage to the O-ring when inserting the pipe into the press fitting. A file, hand deburrer, or an electrical pipe deburrer (suitable for the material) may be used to deburr both inside and outside of the pipe. Burrs sticking to the pipe must be removed.

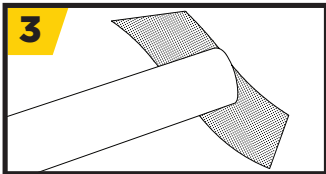

### CLEAN OUTSIDE PIPE SURFACE

Always ensure that any dirt, scale, excessive paint or corrosion particles are removed from the surface of the pipe. This can be done with a wire brush or fine grit sand paper.

The pipe surface of the pipe must be smooth, free of indentations, pits and deformations and must be free of oil and grease.

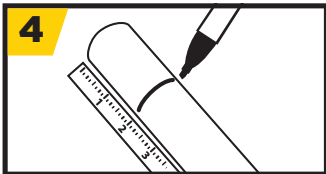

### MARK INSERTION DEPTH

The required insertion depth must be marked on the pipe or the press fitting (the latter for fittings with pipe ends) in order to guarantee a safe and proper joint. The pressing operation behind the bead is of crucial importance for the tensile strength.

The marking on the pipe must remain visible (but close to the fitting) after the connection is pressed to identify any movement before or after pressing.

NOMINAL PIPE SIZE (IN.)	INSERTION DEPTH (IN.)
1/2	1.07
3/4	1.17
1	1.36
1-1/4	1.85
1-1/2	1.87
2	2.01

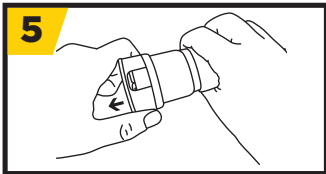

### CHECK FITTING & PIPE

Before assembly, the protective cap must first be removed from fitting. Next, the fitting must be checked to ensure that the O-rings are present and correctly positioned. The pipe, fitting and O-ring must be examined for any foreign materials (e.g. dirt, burrs) and removed, if present. Please make sure that the Visual Inspection Ring (VIR) ring is properly aligned before pressing.

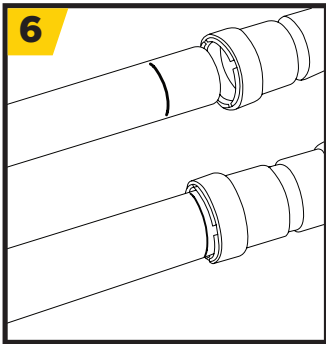

### INSERT PIPE

Insert the pipe carefully into the press fitting up to the marked insertion depth, without tilting, pushing it in the direction of the axis. The insertion depth marking must remain visible. In the case of fittings without a stop the fittings should be inserted at least as far as the marked insertion depth. Rough and careless insertion of the pipe into the press fitting may result in damage to the O-ring and is therefore not permitted.

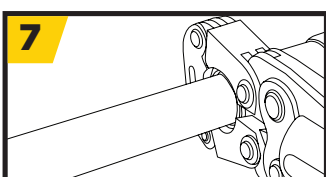

### PRESS THE CONNECTION

Before starting to press, the press jaws and slings must be checked for dirt or debris, and removed if present. Furthermore, the press tool must be in good condition and properly maintained in accordance with the instructions for operating the device, per the manufacturer's instructions. In order to create a correctly pressed connection, the groove of the press tool must enclose the press fitting O-ring bead. Once the pressing has started, always complete the press cycle and under no circumstances interrupt the process.

**It is not permitted to press a connection more than once.**

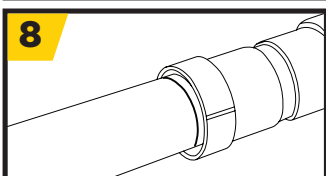

### VERIFY PRESS CONNECTION

Once the tool has fully cycled, the pressed connection must be visually inspected to ensure a proper connection has been made. When the press tool has fully cycled, the visual inspection tabs will break away, indicating a complete press. In some cases, it is possible for a visual inspection tab to get stuck between the inner diameter of the fitting and the pipe after breaking away, giving off the appearance of an un-pressed fitting. This shouldn't alarm the installer, as it will have no bearing on the performance or functionality of the fitting itself. Simply remove the tab by hand, or, by using a thin tool such as a flat head screwdriver.