

You can't beat the system.®

Plastics

TECHNICAL AND INSTALLATION MANUAL

ABS DWV
PVC DWV

RePVC® DWV Pipe with Recycled Content
PVC Sewer & Pressure Pipe
PVC Schedule 40 & 80
FlowGuard Gold® CTS CPVC
ReUze® CTS CPVC
Corzan® Schedule 80 CPVC

(Updated February 17, 2012)



Monroe, North Carolina



Muncy, Pennsylvania



Cameron, Texas



Wildwood, Florida

Charlotte Pipe® has been relentless in our commitment to quality and service for more than a century. Through the years we have broadened and enhanced our product lines to better serve our customers. As the leading full-line manufacturer of PVC, CPVC, and ABS piping systems for drainage and pressure applications, we welcome the opportunity to be the one-stop source for all your thermoplastic piping systems. Charlotte® is the only company that manufactures pipe and fittings to exacting TrueFit tolerances. Our systems are designed to fit together precisely for easier installation, fewer callbacks and a lifetime of trouble-free service - the major benefits of a Charlotte Pipe TrueFit® system.

You can't beat the system.®



Huntsville, Alabama



Cedar City, Utah

CHARLOTTE
PIPE AND FOUNDRY COMPANY®

Manufacturing Facilities

- Monroe, North Carolina
- Muncy, Pennsylvania
- Cameron, Texas
- Wildwood, Florida
- Huntsville, Alabama
- Cedar City, Utah



MEMBER OF
ASTM

Charlotte Pipe, Charlotte, Charlotte Pipe TrueFit, RePVC, ReUze, and "You can't beat the system" are registered trademarks of Charlotte Pipe and Foundry Company.

TABLE OF CONTENTS

GENERAL INFORMATION	Page
Introduction	2
Understanding Safety-Alert Messages	5
Major Advantages of ABS, PVC and CPVC Pipe	6
Handling and Storage of ABS, PVC and CPVC Pipe	7
Physical Properties of ABS and PVC Materials	8
ABS and PVC Standards	8
Physical Properties of FlowGuard Gold®, ReUze® and Corzan® CPVC Materials	9
CPVC Standards	9
Product Specifications	10-21
ABS Cellular Core (Foam Core) Pipe and ABS DWV Fitting System	10
PVC Schedule 40 Solid Wall Pipe and PVC DWV Fitting System	11
PVC Cellular Core (Foam Core) Pipe and PVC DWV Fitting System	12
RePVC® - PVC Schedule 40 Pipe with Recycled Content and PVC DWV Fitting System	13
PVC Schedule 40 Pressure Pipe and Fitting System.....	14
PVC SDR Pressure Pipe and Fitting System.....	15
PVC Schedule 80 Pressure Pipe and Fitting System.....	16
FlowGuard Gold CPVC CTS Pipe and Fitting System.....	17
ReUze® CPVC CTS Pipe and Fitting System.....	18
PVC SDR 35 Gravity Sewer Pipe.....	19
PVC D 2729 Sewer and Drain Pipe.....	20
Product Certification	21
PRODUCT DATA	
Pipe Reference Guide	22
Product Data (Dimensions, Weight and Pressure Ratings)	23-39
Socket Dimensions for Belled-End Pipe	34
DESIGN AND ENGINEERING DATA	
Pressure/Temperature Relationship	40-41
Maximum Operating Temperatures for Various Piping Systems	40
Temperature De-Rating for PVC and CPVC.....	40
Maximum Operating Temperatures for CTS CPVC SDR 11 Piping Systems	41
Low Temperature Recommendations.....	41
Fluid Flow Properties	42-51
Gravity Flow and Fluid Flow Rate	42
Pressure Flow Rate	43
Water Velocities	43
Friction Loss Through Fittings	43
Water Hammer	44-45
Entrapped Air.....	46
Weathering / UV Exposure / Heat Build-Up.....	46
Friction Loss and Flow Velocity Table	47-51
Support Spacing for ABS, PVC and CPVC Pipe	52-53
Typical Pipe Hangers, Clamps, and Supports	53
Expansion and Contraction of Iron Pipe Size ABS, PVC and CPVC	54-56
Thermal Expansion in DWV Systems.....	55
Thermal Expansion in Underground Systems.....	55
Expansion and Contraction of CTS CPVC.....	56
Permissible Bending Deflections for FlowGuard Gold® Pipe.....	57
Flame Spread and Smoke Development Rating for ABS, PVC and CPVC	58
Chemical Resistance Chart of ABS, PVC, and CPVC	59-79
Helpful Reference Standards	80-83
Conversion Charts	84-85

TABLE OF CONTENTS

INSTALLATION

Installation Procedures for ABS, PVC and CPVC Piping Systems	86-94
FlowGuard Gold and ReUze® CTS CPVC Pipe and Fitting Systems.....	86-88
1/2"-4" ABS, PVC and CPVC Pipe and Fitting Systems.....	88-90
6" and Larger ABS, PVC and CPVC Pipe and Fitting Systems.....	90-93
Solvent Cements.....	94
Applicator Types.....	94
Joint Curing	95
Flanges	96
Threaded Joints and Threading of PVC and CPVC Pipe	97-100
External Taper Thread Dimensions	100
Important Information for Fittings with Plastic or Metal Nuts	100
Joining Roll-Grooved Pipe	101
Antifreeze Solutions - Pressure Testing CPVC and PVC at Reduced Temperatures	101
Antifreeze Solutions for ABS DWV Systems	102
Underground Installation	102
Trenching.....	102
Bedding and Backfilling.....	102
CTS CPVC Under-Slab Installations	103
ABS and PVC Under-Slab Instalations	103
In-Slab Installations	103
Testing and Inspection	103
Testing DWV System	103
Testing Pressure System	104

SPECIAL CONSIDERATIONS

FlowGuard Gold® Domestic Water Systems	105
Advantages of a FlowGuard Gold CPVC System	105
Chemical Compatibility with CPVC Products	105
CTS CPVC Pipe Passing Through Studs	106
Closed-Loop Systems	106
Connecting CTS CPVC to Fixtures or Other Materials	106-107
Disinfection	107
Elevated-Temperature Performance	107-108
Horizontal and Vertical Support	108
HVAC Condensate Drain Lines	108
Low Temperature Recommendation	108
Cold Weather Considerations for CPVC	109
Heat Build-Up	109
Thermal Conductivity and Sweating of CTS CPVC	109-110
Water Hammer Arrestors	110
FlowGuard Gold and Corzan Domestic Water Systems Do's and Dont's	110-111
Hydronic Heating Applications	112-113
Material Selection, Special System Design and Engineering Considerations	114-115
Selection of Material for Sanitary and Storm Drainage	114
Engineered Applications	114
Unstable Soil	114
Using Plastics in Multi-Story Construction	115
Using Plastics for Venting Combustion Gases	115
Repairs or Modifications to Existing CPVC CTS Systems	115

LIMITED WARRANTY	116
-------------------------------	-----

FLOWGUARD GOLD CPVC CTS LIMITED WARRANTY	117
---	-----

Understanding Safety Alert Messages

It is important to read and understand this manual. It contains information to help protect your safety and prevent problems.



This is the safety alert symbol. It is used to alert you to potential personal injury hazards. Obey all safety messages that follow this symbol to avoid personal injury or death.

WARNING

“WARNING” Indicates a hazardous situation which, if not avoided, could result in severe injury or death.

CAUTION

“CAUTION” Indicates a hazardous situation which, if not avoided, could result in minor or moderate injury.

NOTICE

“NOTICE” Indicates a hazardous situation which, if not avoided, may result in system failure and property damage.

Major Advantages of ABS, PVC and CPVC Pipe

- While ABS, PVC and CPVC are very different materials, they share numerous advantages common to plastic piping systems. Advantages include ease of installation, corrosion resistance, low friction loss, initial cost, and longevity.

Easy Installation

- ABS, PVC and CPVC systems are light in weight (approximately one-half the weight of aluminum and one-sixth the weight of steel) reducing transportation, handling, and installation cost. They have smooth, seamless interior walls. No special tools are required for cutting. These materials can be installed using the solvent cement joining technique.

Strength

- ABS, PVC and CPVC products are highly resilient, tough and durable with high tensile and high impact strength.

Freedom from Toxicity, Odors, Tastes

- PVC and CPVC piping systems designed for domestic water applications are listed to conform to NSF International Standard 61. This Health Effects standard ensures the safety of products coming into contact with drinking water.

Corrosion Free External and Internal

- With many other pipe materials, slight corrosion may occur. The corroded particles can contaminate the piped fluid, complicating further processing, or causing bad taste, odors, or discoloration. This is particularly undesirable when the piped fluid is for domestic consumption. With PVC and CPVC, there are no corrosive by-products, therefore, no contamination of the piped fluid.

Immunity to Galvanic or Electrolytic Attack

- ABS, PVC and CPVC are inherently immune to galvanic or electrolytic action. They can be used underground, underwater, in the presence of metals, and can be connected to metals.

Fire Resistance

- PVC and CPVC piping systems are self extinguishing and will not support combustion. The ASTM E 84 test protocol is used to determine the flame and smoke rating for various materials.

- PVC will not pass the ASTM E-84 25/50 flame spread / smoke developed test and is not acceptable for use in plenum areas.
- Consult Charlotte Pipe for additional information on CPVC in plenum applications.
- For plenum applications, follow prevailing code requirements.

Low Friction Loss

- The smooth interior surfaces of ABS, PVC and CPVC assure low friction loss and high flow rate. Additionally, since ABS, PVC and CPVC pipe resist rusting, pitting, scaling and corrosion, the high flow rate can be maintained for the life of the piping system.

Low Thermal Conductivity

- PVC and CPVC pipe have a much lower thermal conductivity factor than metal pipe. Therefore, fluids being piped maintain a more constant temperature. In many cases, pipe insulation is not required.

Cost Effective

- ABS, PVC and CPVC products are extremely light weight, convenient to handle, relatively flexible, and easy to install. These features lead to lower installed cost than other piping systems.

Virtually Maintenance Free

- Once an ABS, PVC or CPVC system is properly selected, designed, and installed, it is virtually maintenance free. Therefore, years of trouble-free service can be expected when using Charlotte Pipe and Foundry ABS, PVC and CPVC systems.

 **WARNING**

Testing with or use of compressed air or gas in PVC / ABS / CPVC pipe or fittings can result in explosive failures and cause severe injury or death.

AIR/GAS



- NEVER test with or transport/store compressed air or gas in PVC / ABS / CPVC pipe or fittings.
- NEVER test PVC / ABS / CPVC pipe or fittings with compressed air or gas, or air over water boosters.
- ONLY use PVC / ABS / CPVC pipe for water or approved chemicals.
- Refer to warnings in PPFA User Bulletin 4-80 and ASTM D 1785.

To the best of our knowledge the information contained in this publication is accurate. However, Charlotte Pipe and Foundry does not assume any liability whatsoever for the accuracy or completeness of such information. Final determination of the suitability of any information or product for the use to be contemplated is the sole responsibility of the user. The manner of that use and whether there is any infringement of patents is also the sole responsibility of the user.

Handling and Storage of ABS, PVC and CPVC Pipe

Receiving Pipe

As pipe is received, it must always be thoroughly inspected, prior to unloading. The person receiving the pipe must look for any transportation damage caused by over-tightened tie-down straps, improper treatment, or a shift in the load.

Pipe received in a closed trailer must be inspected as the trailer is opened. Take extra time to ensure that the pipe has not been damaged by other materials having been stacked on top of it, load shift, or rough handling.

Visually examine the pipe ends for any cracks, splits, gouges, or other forms of damage. Additionally, the pipe should be inspected for severe deformation which could later cause joining problems. The entire inside diameter of larger diameter pipe (4" and above) must be checked for any internal splits or cracks which could have been caused by loading or transit. The use of a flashlight may be necessary to perform this inspection.

Any damages must be observed by all parties involved, including the driver, and should be clearly noted on the bill of lading and/or delivery ticket. A copy of this document should be retained by the receiver. In addition, the manufacturer and carrier should be notified, within 24 hours, of any damages, shortages, or mis-shipped products.

Handling Pipe

The pipe should be handled with reasonable care. Because thermoplastic pipe is much lighter in weight than metal pipe, there is sometimes a tendency to throw it around. This should be avoided.

The pipe should never be dragged or pushed from a truck bed. Removing and handling pallets of pipe should be done with a

forklift. Loose pipe lengths require special handling to avoid damage. Precautions to follow when unloading and handling loose pieces include not banging lengths together or dropping lengths, even from low heights, on hard or uneven surfaces.

In all cases, severe contact with any sharp objects (rocks, angle irons, forks on forklifts, etc.) should be avoided. Also, the pipe should never be lifted or moved by inserting the forks of a forklift into the pipe ends.

Handling PVC and particularly CPVC pipe diameters greater than 4-inch requires extra care as the added pipe weight can cause cracking from relatively minor impacts. Also, plastic pipe becomes more brittle as the temperature decreases. The impact strength and flexibility of PVC and especially CPVC pipe are reduced. Therefore, take extra care when handling skids or loose lengths when the temperature drops below 50°F.

Storing Pipe

If possible, pipe should be stored inside. When this is not possible, the pipe should be stored on level ground which is dry and free from sharp objects. If different schedules of pipe are stacked together, the pipe with the thickest walls should be on the bottom.

If the pipe is in pallets, the pallets should be stacked with the pallet boards touching, rather than pallet boards being placed on the pipe. This will prevent damage to or bowing of the pipe.

If the pipe is stored in racks, it should be continuously supported along its length. If this is not possible, the spacing of the supports should not exceed three feet (3').

The pipe should be protected from the sun and be in an area with proper ventilation. This will lessen the effects of ultraviolet rays and help prevent heat build-up.

GENERAL INFORMATION

Physical Properties of Charlotte Pipe® ABS and PVC Materials*

PROPERTY	UNITS	ABS	ASTM NO.	PVC	ASTM NO.
Specific Gravity	g/cc	1.05	D 792	1.40	D 792
Tensile Strength (73°F) Minimum	Psi	4,500	D 638	7,000	D 638
Modulus of Elasticity in Tension (73°F) Minimum	Psi	240,000	D 638	400,000	D 638
Flexural Strength (73°F)	Psi	10,585	D 790	14,000	D 790
Izod Impact (notched at 73°F) Minimum	ft lb/ in. of notch	6.00	D 256	0.65	D 256
Hardness (Durometer D)		70	D 2240	80 ± 3	D 2240
Hardness (Rockwell R)		100	D 785	110 - 120	D 785
Compressive Strength (73°F)	Psi	7,000	D 695	9,600	D 695
Hydrostatic Design Stress	Psi	N/A		2,000	D 1598
Coefficient of Linear Expansion	in./ in./ °F	5.5 x 10 ⁻⁵	D 696	3.0 x 10 ⁻⁵	D 696
Heat Distortion Temperature at 264 psi Minimum	degrees F	180	D 648	160	D 648
Coefficient of Thermal Conductivity	BTU/ hr/sq ft/ °F/ in.	1.1	C 177	1.2	C 177
Specific Heat	BTU/ °F/lb	0.35	D 2766	0.25	D 2766
Water Absorption (24 hrs at 73°F)	% weight gain	0.40	D 570	.05	D 570
Cell Classification - Pipe		42222	D 3965	12454	D 1784
Cell Classification - Fittings		32222	D 3965	12454	D 1784
Burning Rate				Self Ext.	D 635
Burning Class				V-0	UL 94**

*Above data is based upon information provided by the raw material manufacturers. It should be used only as a recommendation and not as a guarantee of performance. **Underwriters Laboratories standard

ABS and PVC Standards

TYPE PIPE / FITTING	STANDARD SPECIFICATIONS	
	MATERIAL	DIMENSIONS
ABS DWV		
Schedule 40 DWV Foam Core Pipe	ASTM D 3965	ASTM F 628
Schedule 40 DWV Fittings	ASTM D 3965	ASTM D 2661
PVC DWV		
Schedule 40 DWV Pipe	ASTM D 1784	ASTM D 2665 & ASTM D 1785
Schedule 40 DWV Foam Core Pipe	ASTM D 4396	ASTM F 891
Schedule 40 DWV Pipe with Recycled Content	ASTM D 4396	ASTM F 1760
Schedule 40 DWV Fittings	ASTM D 1784	ASTM D 2665
Fabricated Schedule 40 DWV Fittings	ASTM D 1784	ASTM F 1866
PVC Pressure		
Schedule 40 Plain End Pipe	ASTM D 1784	ASTM D 1785
Schedule 40 Bell End Pipe	ASTM D 1784	ASTM D 1785
Schedule 40 Bell End Well Casing	ASTM D 1784	ASTM D 1785 & ASTM F 480
SDR 21 (PR 200) Bell End Pipe	ASTM D 1784	ASTM D 2241
SDR 26 (PR 160) Bell End Pipe	ASTM D 1784	ASTM D 2241
Schedule 40 Fittings	ASTM D 1784	ASTM D 2466
Schedule 80 Plain End Pipe	ASTM D 1784	ASTM D 1785
Schedule 80 Fittings	ASTM D 1784	ASTM D 2464 & ASTM D 2467

Physical Properties of FlowGuard Gold®, ReUze® & Corzan® CPVC Materials*

PROPERTY	CPVC 4120	UNITS	ASTM No.
Specific Gravity	1.55	g/cc	D 792
Tensile Strength (73°F) Minimum	7,000	psi	D 638
Modulus of Elasticity in Tension (73°F)	360,000	psi	D 638
Flexural Strength (73°F)	15,100	psi	D 790
Izod Impact Cell Class 23447 (notched at 73°F) Minimum	1.5	ft lb/ in. of notch	D 256
Izod Impact Cell Class 24448 (notched at 73°F) Minimum	5.0	ft lb/ in. of notch	D 256
Hardness (Durometer D)	—		D 2240
Hardness (Rockwell R)	119		D 785
Compressive Strength (73°F)	10,100	psi	D 695
Hydrostatic Design Stress	2,000	psi	
Coefficient of Linear Expansion	3.4 x 10 ⁻⁵	in./ in./ °F	D 696
Heat Distortion Temperature at 264 psi Minimum	212 (Cell Class 23447)	degrees F	D 648
Heat Distortion Temperature at 264 psi Minimum	230 (Cell Class 24448)	degrees F	D 648
Coefficient of Thermal Conductivity	.95	BTU/ hr/sq ft/ °F/ in.	C 177
Specific Heat	.34	BTU/ °F/lb	D 2766
Water Absorption (24 hrs at 73°F)	.03	% weight gain	D 570
Cell Classification	23447 - 24448		D 1784
Burning Rate	Self Extinguishing		D 635
Burning Class	V-0		UL 94**

*Above data is based upon information provided by the raw material manufacturers. It should be used only as a recommendation and not as a guarantee of performance. **Underwriters Laboratories standard

CPVC Standards

TYPE PIPE / FITTINGS	STANDARD SPECIFICATIONS	
	MATERIAL	DIMENSIONS
CPVC Pressure		
CPVC Schedule 80 Plain End Pipe (Corzan)	ASTM D 1784	ASTM F 441
CPVC Schedule 80 Fittings (Corzan)	ASTM D 1784	ASTM F 437 and ASTM F 439
CPVC CTS Tube and Fittings (FlowGuard Gold, ReUze®)	ASTM D 1784	ASTM D 2846

Product Specifications

System: **ABS Cellular Core (Foam Core) Pipe and ABS DWV Fitting System**

Scope: This specification covers ABS cellular core (foam core) pipe and ABS DWV fittings used in sanitary drain, waste, and vent (DWV), sewer, and storm drainage applications. This system is intended for use in non-pressure applications where the operating temperature will not exceed 140°F.

Specification: Pipe shall be manufactured from virgin rigid ABS (acrylonitrile-butadiene-styrene) compounds with a Cell Class of 42222 as identified in ASTM D 3965. Fittings shall be manufactured from virgin rigid ABS compounds with a Cell Class of 32222 as identified in ASTM D 3965.

ABS cellular core pipe shall be Iron Pipe Size (IPS) conforming to ASTM F 628. ABS DWV fittings shall conform to ASTM D 2661. Pipe and fittings shall be manufactured as a system and be the product of one manufacturer. All pipe and fittings shall be manufactured in the United States. All systems shall utilize a separate waste and vent system. Pipe and fittings shall conform to NSF International Standard 14.

Installation shall comply with the latest installation instructions published by Charlotte Pipe and Foundry and shall conform to all applicable plumbing, fire, and building code requirements. Buried pipe shall be installed in accordance with ASTM D 2321 and ASTM F 1668. Solvent cement joints shall be made with a solvent cement conforming to ASTM D 2235. The system shall be protected from chemical agents, fire stopping materials, thread sealant, or other aggressive chemical agents not compatible with ABS compounds. Systems shall be hydrostatically tested after installation. **WARNING!** Never test with or transport/store compressed air or gas in ABS pipe or fittings.

Referenced Standards*:

ASTM D 3965	Rigid ABS Compounds
ASTM F 628	Co-extruded ABS Pipe with Cellular Core
ASTM D 2661	ABS Drain, Waste, and Vent Fittings
ASTM D 2235	Solvent Cements for ABS Pipe and Fittings
ASTM D 2321	Underground Installation of Thermoplastic Pipe (non-pressure applications)
ASTM F 1668	Procedures for Buried Plastic Pipe
NSF Standard 14	Plastic Piping Components and Related Materials

*Note: Latest revision of each standard applies.

Short Specification:

Pipe and fittings shall be manufactured from ABS compound with a cell class of 42222 for pipe and 32222 for fittings as per ASTM D 3965 and conform with NSF International Standard 14. Pipe shall be iron pipe size (IPS) conforming to ASTM F 628. Fittings shall conform to ASTM D 2661.

All pipe and fittings shall be produced by a single manufacturer and shall be installed in accordance with manufacturer's recommendations and applicable code requirements. Buried pipe shall be installed in accordance with ASTM D 2321 and ASTM F 1668. Solvent cement shall conform to ASTM D 2235. The system is to be manufactured by Charlotte Pipe and Foundry Company and is intended for non-pressure drainage applications where the temperature will not exceed 140°F.

Product Specifications

System: PVC Schedule 40 Solid Wall Pipe and PVC DWV Fitting System

Scope: This specification covers PVC Schedule 40 solid wall pipe and PVC DWV fittings used in sanitary drain, waste, and vent (DWV), sewer, and storm drainage applications. This system is intended for use in non-pressure applications where the operating temperature will not exceed 140°F.

Specification: Pipe and fittings shall be manufactured from virgin rigid PVC (polyvinyl chloride) vinyl compounds with a Cell Class of 12454 as identified in ASTM D 1784.

PVC Schedule 40 pipe shall be Iron Pipe Size (IPS) conforming to ASTM D 1785 and ASTM D 2665. Injection molded PVC DWV fittings shall conform to ASTM D 2665. Fabricated PVC DWV fittings shall conform to ASTM F 1866. Pipe and fittings shall be manufactured as a system and be the product of one manufacturer. All pipe and fittings shall be manufactured in the United States. All systems shall utilize a separate waste and vent system. Pipe and fittings shall conform to NSF International Standard 14.

Installation shall comply with the latest installation instructions published by Charlotte Pipe and Foundry and shall conform to all applicable plumbing, building, and fire code requirements. Buried pipe shall be installed in accordance with ASTM D 2321 and ASTM F 1668. Solvent cement joints shall be made in a two step process with primer conforming to ASTM F 656 and solvent cement conforming to ASTM D 2564. The system shall be protected from chemical agents, fire stopping materials, thread sealant, plasticized vinyl products, or other aggressive chemical agents not compatible with PVC compounds. Systems shall be hydrostatically tested after installation. **WARNING!** Never test with or transport/store compressed air or gas in PVC pipe or fittings.

Referenced Standards*:

ASTM D 1784	Rigid Vinyl Compounds
ASTM D 1785	PVC Plastic Pipe, Schedule 40
ASTM D 2665	PVC Drain, Waste, and Vent Pipe & Fittings
ASTM D 2564	Solvent Cements for PVC Pipe and Fittings
ASTM D 2321	Underground Installation of Thermoplastic Pipe (non-pressure applications)
ASTM F 656	Primers for PVC Pipe and Fittings
ASTM F 1668	Procedures for Buried Plastic Pipe
ASTM F 1866	Fabricated PVC DWV Fittings
NSF Standard 14	Plastic Piping Components and Related Materials

*Note: Latest revision of each standard applies.

Short Specification:

Pipe and fittings shall be manufactured from PVC compound with a cell class of 12454 per ASTM D 1784 and conform with NSF International Standard 14. Pipe shall be iron pipe size (IPS) conforming to ASTM D 1785 and ASTM D 2665. Injection molded fittings shall conform to ASTM D 2665. Fabricated fittings shall conform to ASTM F 1866.

All pipe and fittings shall be produced by a single manufacturer and shall be installed in accordance with manufacturer's recommendations and applicable code requirements. Buried pipe shall be installed in accordance with ASTM D 2321 and ASTM F 1668. Solvent cements shall conform to ASTM D 2564, primer shall conform to ASTM F 656. The system is to be manufactured by Charlotte Pipe and Foundry Company and is intended for non-pressure drainage applications where the temperature will not exceed 140°F.

Product Specification

System: PVC Cellular Core (Foam Core) Pipe and PVC DWV Fitting Systems

Scope: This specification covers PVC cellular core (foam core) pipe and PVC DWV fittings used in sanitary drain, waste, and vent (DWV), sewer, and storm drainage applications. This system is intended for use in non-pressure applications where the operating temperature will not exceed 140°F.

Specification: Pipe shall be manufactured from virgin rigid PVC (polyvinyl chloride) vinyl compounds with a Cell Class of 11432 as identified in ASTM D 4396. Fittings shall be manufactured from virgin rigid PVC (polyvinyl chloride) vinyl compounds with a Cell Class of 12454 as identified in ASTM D 1784.

PVC cellular core pipe shall be Iron Pipe Size (IPS) conforming to ASTM F 891. Injection molded PVC DWV fittings shall conform to ASTM D 2665. Fabricated PVC DWV fittings shall conform to ASTM F 1866. Pipe and fittings shall be manufactured as a system and be the product of one manufacturer. All pipe and fittings shall be manufactured in the United States. All systems shall utilize a separate waste and vent system. Pipe and fittings shall conform to NSF International Standard 14.

Installation shall comply with the latest installation instructions published by Charlotte Pipe and Foundry and shall conform to all applicable plumbing, fire, and building code requirements. Buried pipe shall be installed in accordance with ASTM D 2321 and ASTM F 1668. Solvent cement joints shall be made in a two step process with primer conforming to ASTM F 656 and solvent cement conforming to ASTM D 2564. The system shall be protected from chemical agents, fire stopping materials, thread sealant, plasticized vinyl products, or other aggressive chemical agents not compatible with PVC compounds. Systems shall be hydrostatically tested after installation. **WARNING!** Never test with or transport/store compressed air or gas in PVC pipe or fittings.

Referenced Standards*:

ASTM D 4396	Compounds for Cellular Core Pipe
ASTM F 891	Co-extruded PVC Pipe with Cellular Core
ASTM D 2665	PVC Drain, Waste, and Vent Fittings
ASTM D 2564	Solvent Cements for PVC Pipe and Fittings
ASTM D 2321	Underground Installation of Thermoplastic Pipe (non-pressure applications)
ASTM F 656	Primers for PVC Pipe and Fittings
ASTM F 1668	Procedures for Buried Plastic Pipe
ASTM F 1866	Fabricated PVC DWV Fittings
NSF Standard 14	Plastic Piping Components and Related Materials

*Note: Latest revision of each standard applies.

Short Specification:

Pipe shall be manufactured from PVC compound with a cell class of 11432 per ASTM D 4396 and 12454 per ASTM D 1784 for fittings and conform with NSF International Standard 14. Pipe shall be iron pipe size (IPS) conforming to ASTM F 891. Injection molded PVC DWV fittings shall conform to ASTM D 2665. Fabricated PVC DWV fittings shall conform to ASTM F 1866.

All pipe and fittings shall be produced by a single manufacturer and shall be installed in accordance with manufacturer's recommendations and applicable code requirements. Buried pipe shall be installed in accordance with ASTM D 2321 and ASTM F 1668. Solvent cements shall conform to ASTM D 2564, primer shall conform to ASTM F 656. The system is to be manufactured by Charlotte Pipe and Foundry Company and is intended for non-pressure drainage applications where the temperature will not exceed 140°F.

Product Specification

System: RePVC® – PVC Schedule 40 Pipe with Recycled Content and PVC DWV Fitting System

Scope: This specification covers PVC Schedule 40 pipe with recycled content and PVC DWV fittings used in sanitary drain, waste, and vent (DWV), sewer and storm drainage applications. This system is intended for use in non-pressure applications where the operating temperature will not exceed 140°F.

Specification: Inside and outside layers of pipe shall be manufactured from virgin rigid PVC (polyvinyl chloride) vinyl compounds with a minimum cell class of 11432 per ASTM D 4396. Center layer of pipe shall be manufactured from recycled PVC compounds with a minimum cell class of 11211 per ASTM D 4396. Fittings shall be manufactured from virgin rigid PVC (polyvinyl chloride) vinyl compounds with a cell class of 12454 as identified in ASTM D 1784.

Center layer of pipe shall be comprised of 100% recycled material and make up 30 – 80% of the pipe's overall wall thickness.

Coextruded PVC pipe with recycled content shall be Schedule 40 iron pipe size (IPS) conforming to ASTM F 1760. Injection molded PVC DWV fittings shall conform to ASTM D 2665. Fabricated PVC DWV fittings shall conform to ASTM F 1866. Pipe and fittings shall be manufactured as a system and be the product of one manufacturer. All pipe and fittings shall be manufactured in the United States. All systems shall utilize a separate waste and vent system. Pipe and fittings shall conform to NSF International Standard 14.

Installation shall comply with the latest installation instructions published by Charlotte Pipe and Foundry and shall conform to all applicable plumbing, fire, and building code requirements. Buried pipe shall be installed in accordance with ASTM D 2321 and ASTM F 1668. Solvent cement joints shall be made in a two step process with primer conforming to ASTM F 656 and solvent cement conforming to ASTM D 2564. The system shall be protected from chemical agents, fire stopping materials, thread sealant, plasticized vinyl products, or other aggressive chemical agents not compatible with PVC compounds. Systems shall be hydrostatically tested after installation. **WARNING!** Never test with or transport/store compressed air or gas in PVC pipe or fittings.

Referenced Standards*:

ASTM D 4396	Compounds for Cellular Core Pipe
ASTM F 1760	Co-extruded PVC Pipe with Recycled Content
ASTM D 2665	PVC Drain, Waste, and Vent Fittings
ASTM D 2564	Solvent Cements for PVC Pipe and Fittings
ASTM D 2321	Underground Installation of Thermoplastic Pipe (non-pressure applications)
ASTM F 656	Primers for PVC Pipe and Fittings
ASTM F 1668	Procedures for Buried Plastic Pipe
ASTM F 1866	Fabricated PVC DWV Fittings
NSF Standard 14	Plastic Piping Components and Related Materials

*Note: Latest revision of each standard applies.

Short Specification:

Pipe shall be manufactured from PVC compound with a minimum cell class of 11432 for the inside and outside layers and 11211 for the center layer per ASTM D 4396. Center layer of pipe shall be comprised of 100% recycled material and make up 30 – 80% of the overall wall thickness. Pipe shall be Schedule 40 iron pipe size (IPS) conforming to ASTM F 1760.

Fittings shall be manufactured from virgin rigid PVC compound with a cell class of 23447 per ASTM D 1784 and conform with NSF International Standard 14. Injection molded PVC DWV fittings shall conform to ASTM D 2665. Fabricated PVC DWV fittings shall conform to ASTM F 1866.

All pipe and fittings shall be produced by a single manufacturer and be installed in accordance with manufacturer's recommendations and applicable code requirements. Buried pipe shall be installed in accordance with ASTM D 2321 and ASTM F 1668. Solvent cements shall conform to ASTM D 2564, primer shall conform to ASTM F 656. The system to be manufactured by Charlotte Pipe and Foundry Co. and is intended for non-pressure drainage applications where the temperature will not exceed 140°F.

RePVC is a registered trademark of Charlotte Pipe and Foundry Company.

Product Specifications

System: PVC Schedule 40 Pressure Pipe and Fitting System

Scope: This specification covers PVC Schedule 40 pipe and fittings for pressure applications. This system is intended for pressure applications where the operating temperature will not exceed 140°F.

Specification: Pipe and fittings shall be manufactured from virgin rigid PVC (polyvinyl chloride) vinyl compounds with a Cell Class of 12454 as identified in ASTM D 1784.

PVC Schedule 40 pipe shall be Iron Pipe Size (IPS) conforming to ASTM D 1785. PVC Schedule 40 fittings shall conform to ASTM D 2466. Pipe and fittings shall be manufactured as a system and be the product of one manufacturer. All pipe and fittings shall be manufactured in the United States. Pipe and fittings shall conform to NSF International Standard 61 or the health effects portion of NSF Standard 14.

Installation shall comply with the latest installation instructions published by Charlotte Pipe and Foundry and shall conform to all applicable plumbing, building, and fire code requirements. Buried pipe shall be installed in accordance with ASTM F 1668 and ASTM D 2774. Solvent cement joints shall be made in a two step process with primer conforming to ASTM F 656 and solvent cement conforming to ASTM D 2564. The system shall be protected from chemical agents, fire stopping materials, thread sealant, plasticized vinyl products, or other aggressive chemical agents not compatible with PVC compounds. Systems shall be hydrostatically tested after installation. **WARNING!** Never test with or transport/store compressed air or gas in PVC pipe or fittings.

Referenced Standards*:

ASTM D 1784	Rigid Vinyl Compounds
ASTM D 1785	PVC Plastic Pipe, Schedule 40
ASTM D 2466	PVC Plastic Fittings, Schedule 40
ASTM D 2564	Solvent Cements for PVC Pipe and Fittings
ASTM D 2774	Underground Installation of Thermoplastic Pressure Piping
ASTM F 656	Primers for PVC Pipe and Fittings
ASTM F 1668	Procedures for Buried Plastic Pipe
NSF Standard 14	Plastic Piping Components and Related Materials
NSF Standard 61	Drinking Water System Components - Health Effects

*Note: Latest revision of each standard applies.

Short Specification:

Pipe and fittings shall be manufactured from PVC compound with a cell class of 12454 per ASTM D 1784 and conform with NSF International Standards 14 and 61. Pipe shall be iron pipe size (IPS) conforming to ASTM D 1785. Fittings shall conform to ASTM D 2466.

All pipe and fittings shall be produced by a single manufacturer and shall be installed in accordance with manufacturer's recommendations and applicable code requirements. Buried pipe shall be installed in accordance with ASTM F 1668 and ASTM D 2774. Solvent cements shall conform to ASTM D 2564, primer shall conform to ASTM F 656. The system is to be manufactured by Charlotte Pipe and Foundry Company and is intended for pressure applications where the temperature will not exceed 140°F.

Product Specifications

System: PVC SDR Pressure Pipe and Fitting System

Scope: This specification covers PVC Standard Dimensional Ratio (SDR) pipe and fittings for pressure applications. This system is intended for pressure applications where the operating temperature will not exceed 140°F.

Specification: Pipe and fittings shall be manufactured from virgin rigid PVC (polyvinyl chloride) vinyl compounds with a Cell Class of 12454 as identified in ASTM D 1784.

PVC SDR pipe shall be Iron Pipe Size (IPS) conforming to ASTM D 2241 for plain end pipe and ASTM D 2672 for belled-end pipe. PVC Schedule 40 (IPS) fittings shall conform to ASTM D 2466. Pipe and fittings shall be manufactured as a system and be the product of one manufacturer. All pipe and fittings shall be manufactured in the United States. Pipe and fittings shall conform to NSF International Standard 61 or the health effects portion of NSF Standard 14.

Installation shall comply with the latest installation instructions published by Charlotte Pipe and Foundry and shall conform to all applicable plumbing, building, and fire code requirements. Buried pipe shall be installed in accordance with ASTM F 1668 and ASTM D 2774. Solvent cement joints shall be made in a two step process with primer conforming to ASTM F 656 and solvent cement conforming to ASTM D 2564. The system shall be protected from chemical agents, fire stopping materials, thread sealant, plasticized vinyl products, or other aggressive chemical agents not compatible with PVC compounds. Systems shall be hydrostatically tested after installation. **WARNING!** Never test with or transport/store compressed air or gas in PVC pipe or fittings.

Referenced Standards*:

ASTM D 1784	Rigid Vinyl Compounds
ASTM D 2241	PVC Pressure Rated Pipe (SDR Series)
ASTM D 2672	Joints for IPS PVC Pipe Using Solvent Cement
ASTM D 2466	PVC Plastic Fittings, Schedule 40
ASTM D 2564	Solvent Cements for PVC Pipe and Fittings
ASTM D 2774	Underground Installation of Thermoplastic Pressure Piping
ASTM F 656	Primers for PVC Pipe and Fittings
ASTM F 1668	Procedures for Buried Plastic Pipe
NSF Standard 14	Plastic Piping Components and Related Materials
NSF Standard 61	Drinking Water System Components - Health Effects

*Note: Latest revision of each standard applies.

Short Specification:

Pipe and fittings shall be manufactured from PVC compound with a cell class of 12454 per ASTM D 1784 and conform with NSF International Standards 14 and 61. Pipe shall be iron pipe size (IPS) conforming to ASTM D 2241 for plain-end pipe and ASTM D 2672 for belled-end pipe. PVC Schedule 40 fittings shall conform to ASTM D 2466.

All pipe and fittings shall be produced by a single manufacturer and shall be installed in accordance with manufacturer's recommendations and applicable code requirements. Buried pipe shall be installed in accordance with ASTM F 1668 and ASTM D 2774. Solvent cements shall conform to ASTM D 2564, primer shall conform to ASTM F 656. The system is to be manufactured by Charlotte Pipe and Foundry Company and is intended for pressure applications where the temperature will not exceed 140°F.

Product Specifications

System: PVC Schedule 80 Pressure Pipe and Fitting System

Scope: This specification covers PVC Schedule 80 pipe and fittings for pressure applications. This system is intended for pressure applications where the operating temperature will not exceed 140°F.

Specification: Pipe and fittings shall be manufactured from virgin rigid PVC (polyvinyl chloride) vinyl compounds with a Cell Class of 12454 as identified in ASTM D 1784.

PVC Schedule 80 pipe shall be Iron Pipe Size (IPS) conforming to ASTM D 1785. PVC Schedule 80 fittings shall conform to ASTM D 2467. PVC Schedule 80 threaded fittings shall conform to ASTM D 2464. Pipe and fittings shall be manufactured as a system and be the product of one manufacturer. All pipe and fittings shall be manufactured in the United States. Pipe and fittings shall conform to NSF International Standard 61 or the health effects portion of NSF Standard 14.

Installation shall comply with the latest installation instructions published by Charlotte Pipe and Foundry and shall conform to all applicable plumbing, building, and fire code requirements. Buried pipe shall be installed in accordance with ASTM F 1668 and ASTM D 2774. Solvent cement joints shall be made in a two step process using IPS P-70 or Oatey Industrial Grade primers and solvent cement conforming to ASTM D 2564. The system shall be protected from chemical agents, fire stopping materials, thread sealant, plasticized vinyl products, or other aggressive chemical agents not compatible with PVC compounds. Systems shall be hydrostatically tested after installation. **WARNING!** Never test with or transport/store compressed air or gas in PVC pipe or fittings.

Referenced Standards*:

ASTM D 1784	Rigid Vinyl Compounds
ASTM D 1785	PVC Plastic Pipe, Schedule 80
ASTM D 2464 or D 2467	PVC Threaded Fittings, Schedule 80
ASTM D 2467	PVC Socket Fittings, Schedule 80
ASTM D 2564	Solvent Cements for PVC Pipe and Fittings
ASTM D 2774	Underground Installation of Thermoplastic Pressure Piping
ASTM F 1668	Procedures for Buried Plastic Pipe
NSF Standard 14	Plastic Piping Components and Related Materials
NSF Standard 61	Drinking Water System Components - Health Effects

*Note: Latest revision of each standard applies.

Short Specification:

Pipe and fittings shall be manufactured from PVC compound with a cell class of 12454 per ASTM D 1784 and conform with NSF International Standards 14 and 61. Pipe shall be iron pipe size (IPS) conforming to ASTM D 1785. Socket fittings shall conform to ASTM D 2467; threaded fittings shall conform to ASTM D 2464 or D 2467. Flanges shall meet the bolt pattern requirements of ANSI/ASME B 16.5.

All pipe and fittings shall be produced by a single manufacturer and shall be installed in accordance with manufacturer's recommendations and applicable code requirements. Buried pipe shall be installed in accordance with ASTM F 1668 and ASTM D 2774. Solvent cements shall conform to ASTM D 2564, primer shall be IPS P-70 or Oatey Industrial Grade. The system is to be manufactured by Charlotte Pipe and Foundry Company and is intended for pressure applications where the temperature will not exceed 140°F.

Product Specifications

System: **FlowGuard Gold® CPVC Copper Tube Size (CTS) Hot and Cold Domestic Water Distribution System**

Scope: This specification covers Copper Tube Size (CTS) CPVC manufactured to standard dimensional ratio (SDR) 11 for hot and cold domestic water distribution. This system is intended for pressure applications where the operating temperature will not exceed 180°F at 100 psi.

Specification: Pipe and fittings shall be manufactured from virgin rigid Chlorinated Poly (Vinyl Chloride) (CPVC) compounds with a Cell Class of 24448 for pipe and 23447 for fittings per ASTM D 1784.

FlowGuard Gold CTS CPVC pipe and fittings shall conform to ASTM D 2846. Pipe and fittings shall be manufactured as a system and be the product of one manufacturer. All pipe and fittings shall be manufactured in the United States. Pipe and fittings shall conform to NSF International Standards 14 and 61.

Installation shall comply with latest installation instructions published by Charlotte Pipe and Foundry and shall conform to all applicable plumbing, building and fire code requirements. Buried pipe shall be installed in accordance with ASTM F 1668 and ASTM D 2774. Solvent weld joints shall be made using CPVC cement conforming to ASTM F 493. Yellow one-step cement may be used without primer. If a primer is required by applicable plumbing or building codes, then a primer conforming to ASTM F 656 should be used. The system shall be protected from chemical agents, fire stopping materials, thread sealant, plasticized vinyl products or other aggressive chemical agents not compatible with CPVC compounds. Systems shall be hydrostatically tested after installation. **WARNING!** Never test with or transport/store compressed air or gas in CPVC pipe or fittings.

Referenced Standards*:

ASTM D 1784	Rigid Vinyl Compounds
ASTM D 2774	Underground Installation of Thermoplastic Pressure Piping
ASTM D 2846	CPVC Plastic Hot and Cold Water Distribution System
ASTM F 493	Solvent Cements for CPVC Pipe and Fittings
ASTM F 1668	Procedures for Buried Plastic Pipe
NSF Standard 14	Plastic Piping Components and Related Materials
NSF Standard 61	Drinking Water System Components - Health Effects

*Note: Latest revision of each standard applies.

Short Specification:

Specification for FlowGuard Gold CPVC Copper Tube Size (CTS) Hot and Cold Domestic Water Distribution System

All pipe and fittings shall be manufactured from CPVC compound with a cell class of 24448 for pipe and 23447 for fittings as per ASTM D 1784 and conform with NSF International Standards 14 and 61.

Pipe and fittings to be FlowGuard Gold® CPVC Copper Tube Size manufactured to standard dimension ratio (SDR) 11 and shall conform to ASTM D 2846. Transition fittings to have brass male or female threads with integral CPVC socket connections as manufactured by Charlotte Pipe and Foundry Company.

All pipe and fittings shall be produced by a single manufacturer and shall be installed in accordance with manufacturer's recommendations and applicable code requirements. Buried pipe shall be installed in accordance with ASTM F 1668 and ASTM D 2774. Solvent cement shall conform to ASTM F 493 and system may be installed with approved one-step cement. Pipe and fittings are to be manufactured by Charlotte Pipe and Foundry Company and are intended for hot and cold water distribution systems.

Product Specifications

System: ReUze® CPVC Copper Tube Size (CTS) Non-Potable Water Distribution System

Scope: This specification covers Copper Tube Size (CTS) CPVC manufactured to standard dimensional ratio (SDR) 11 for non-potable water distribution. This system is intended for pressure applications where the operating temperature will not exceed 180°F at 100 psi.

Specification: Pipe and fittings shall be manufactured from virgin rigid Chlorinated Poly (Vinyl Chloride) (CPVC) compounds with a Cell Class of 24448 as identified in ASTM D 1784.

ReUze CTS CPVC pipe and fittings shall conform to ASTM D 2846. Pipe and fittings shall be manufactured as a system and be the product of one manufacturer. All pipe and fittings shall be manufactured in the United States. Pipe and fittings shall conform to NSF International Standard 14. The pipe shall be listed by NSF International for reclaimed water and bear the mark "NSF-rw."

Installation shall comply with latest installation instructions published by Charlotte Pipe and Foundry and shall conform to all applicable plumbing, building and fire code requirements. Buried pipe shall be installed in accordance with ASTM F 1668 and ASTM D 2774. Solvent weld joints shall be made using CPVC cement conforming to ASTM F 493. Yellow one-step cement may be used without primer. If a primer is required by applicable plumbing or building codes, then a primer conforming to ASTM F 656 should be used. The system shall be protected from chemical agents, fire stopping materials, thread sealant, plasticized vinyl products or other aggressive chemical agents not compatible with CPVC compounds. System shall be hydrostatically tested after installation. **WARNING!** Never test with or transport/store compressed air or gas in CPVC pipe or fittings.

Referenced Standards*:

ASTM D 1784	Rigid Vinyl Compounds
ASTM D 2774	Underground Installation of Thermoplastic Pressure Piping
ASTM D 2846	CPVC Plastic Hot and Cold Water Distribution System
ASTM F 493	Solvent Cements for CPVC Pipe and Fittings
ASTM F 1668	Procedures for Buried Plastic Pipe
NSF Standard 14	Plastic Piping Components and Related Materials

*Note: Latest revision of each standard applies.

Short Specification:

All pipe and fittings shall be manufactured from CPVC compound with a cell class of 24448 for pipe and 23447 for fittings as per ASTM D 1784, conform with NSF International Standard 14. The pipe shall be listed by NSF International for reclaimed water and bear the mark "NSF-rw."

1/2" through 2" sizes: ReUze® made with FlowGuard Gold® CPVC Copper Tube Size manufactured to standard dimension ratio (SDR) 11 and shall conform to ASTM D 2846. Pipe shall be purple pigmented and have two rows of marking 180° apart to include "**WARNING: NON-POTABLE WATER DO NOT DRINK**". Fittings shall be either tan or purple in color. Transition fittings shall have brass male or female connections with integral CPVC socket connections as manufactured by Charlotte Pipe and Foundry Company.

All pipe and fittings shall be produced by a single manufacturer and be installed in accordance with manufacturer's recommendations and applicable code requirements. System shall be joined using approved one-step solvent cement conforming to ASTM F 493. Pipe and fittings shall be manufactured by Charlotte Pipe and Foundry Company and are intended for hot and cold non-potable water distribution systems.

ReUze is a registered trademark of Charlotte Pipe and Foundry Company.

Product Specifications

System: PVC SDR 35 Gravity Sewer Pipe

Scope: This specification covers PVC Standard Dimension Ratio (SDR) 35 PSM pipe for gravity sewer and surface water applications with a pipe stiffness of 46. This product is intended for gravity applications where the operating temperature will not exceed 140°F.

Specification: Pipe shall be manufactured from virgin rigid PVC (polyvinyl chloride) vinyl compounds with a cell class of 12364 as identified in ASTM D 1784. The requirements of this specification are intended to provide pipe suitable for non-pressure drainage and surface water.

PVC SDR 35 PSM pipe shall conform to ASTM D 3034 for gasket or solvent weld pipe with a minimum pipe stiffness of 46. Gaskets shall conform to ASTM F 477. The term "PSM" is not an acronym, but rather an arbitrary designation for a product having certain dimensions.

Installation shall comply with the latest installation instructions published by Charlotte Pipe and Foundry and shall conform to all applicable plumbing, and building requirements. Buried pipe shall be installed in accordance with ASTM D 2321 and ASTM F 1668. Solvent cement joints shall be made in a two step process with primer conforming to ASTM F 656 and solvent cement conforming to ASTM D 2564. The pipe shall be protected from chemical agents, plasticized vinyl products, or other aggressive chemical agents not compatible with PVC compounds. Systems shall be hydrostatically tested after installation.
WARNING! Never test with or transport/store compressed air or gas in PVC pipe or fittings.

Referenced Standards*:

ASTM D 1784	Rigid Vinyl Compounds
ASTM D 3034	PVC Gravity Sewer Pipe (SDR) 35 PS 46
ASTM D 2855	Joints For Sewer Pipe Using Solvent Cement
ASTM D 2564	Solvent Cements For PVC Sewer Pipe
ASTM D 2321	Underground Installation of Thermoplastic Pipe (non-pressure applications)
ASTM F 477	Elastomeric Seals (Gaskets) For Joining Plastic Pipe
ASTM F 656	Primers for PVC Pipe and Fittings
ASTM F 1668	Procedures for Buried Plastic Pipe

*Note: Latest revision of each standard applies.

Short Specification:

Pipe shall be manufactured from PVC compound with a cell class of 12364 as per ASTM D 1784. PVC SDR 35 PSM pipe shall conform to ASTM D 3034 for gasket or solvent weld pipe with a minimum pipe stiffness of 46. Pipe shall be plastic sewer main outside diameter with a standard dimension ratio (SDR) of 35. Gaskets shall conform to ASTM F 477.

All pipe shall be produced by a single manufacturer and shall be installed in accordance with manufacturer's recommendations and applicable code requirements. Buried pipe shall be installed in accordance with ASTM D 2321 and ASTM F 1668. Solvent cements shall conform to ASTM D 2564, primer shall conform to ASTM F 656. Pipe is to be manufactured by Charlotte Pipe and Foundry Company and is intended for non-pressure gravity sewer and surface water applications.

Product Specifications

System: PVC D 2729 Sewer and Drain Pipe

Scope: This specification covers PVC D 2729 Sewer Pipe for drainage applications. This pipe is intended for drainage applications where the operating temperature will not exceed 140°F.

Specification: Pipe shall be manufactured from virgin rigid PVC (polyvinyl chloride) vinyl compounds with a Cell Class of 12454 as identified in ASTM D 1784.

PVC D 2729 Sewer Pipe dimensions and physical properties shall conform to ASTM D 2729. All pipe shall be manufactured in the United States.

Installation shall comply with the latest installation instructions published by Charlotte Pipe and Foundry and shall conform to all applicable plumbing, building, and fire code requirements. Buried pipe shall be installed in accordance with ASTM D 2321 and ASTM F 1668. Solvent cement joints shall be made in a two step process with primer conforming to ASTM F 656 and solvent cement conforming to ASTM D 2564. The system shall be protected from chemical agents, fire stopping materials, thread sealant, plasticized vinyl products, or other aggressive chemical agents not compatible with PVC compounds. Systems shall be hydrostatically tested after installation. **WARNING!** Never test with or transport/store compressed air or gas in PVC pipe or fittings.

Referenced Standards*:

- ASTM D 1784 Rigid Vinyl Compounds
- ASTM D 2729 PVC Sewer Pipe
- ASTM D 2564 Solvent Cements for PVC Pipe and Fittings
- ASTM F 656 Primer for PVC Pipe and Fittings
- ASTM D 2321 Underground Installation of Thermoplastic Pipe (non-pressure applications)
- ASTM F 656 Primers for PVC Pipe and Fittings
- ASTM F 1668 Procedures for Buried Plastic Pipe

*Note: Latest revision of each standard applies.

Short Specification:

Pipe shall be manufactured from PVC compound with a cell class of 12454 per ASTM D 1784. Pipe dimensions and physical properties shall conform to ASTM D 2729.

All pipe to be produced by a single manufacturer and to be installed in accordance with manufacturer's recommendations and all applicable code requirements. Solvent cements shall conform to ASTM D 2564, primer shall conform to ASTM F 656. The pipe is to be manufactured by Charlotte Pipe and Foundry Company and is intended for drainage applications where the temperature will not exceed 140°F.

PVC Sewer and Drain ASTM D 2729							
Nominal Size	Part No.	UPC 611942-	Type	O.D. (In.)	Min. Wall (In.)	Ft/Skid	Wt/100' (Lbs.)
3"	PVC 30030	10903	Solid	3.250	0.070	810	52.8
3"	PVC 30030P	11814	Perforated	3.250	0.070	810	52.8
4"	PVC 30040	10905	Solid	4.215	0.075	500	70.4
4"	PVC 30040P	11815	Perforated	4.215	0.075	500	70.4

**Perforation Detail
2-Hole 120 Degree**

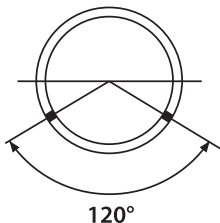

Product Certification



This is to certify that all Plastic Pipe and Fittings manufactured by Charlotte Pipe and Foundry Company are manufactured in the United States and conform to the following standards:

SCH. 40 PVC PIPE

ASTM D 1784, ASTM D 1785, ASTM D 2665
FHA UM 79a
FEDERAL SPECIFICATION L-P-320a
NSF STANDARD 14 AND 61

SCH. 40 PVC DWV PIPE CELLULAR CORE

ASTM D 4396, ASTM F 891
NSF STANDARD NO. 14

RePVC® DWV PIPE WITH RECYLED CONTENT

ASTM D 4396, ASTM F 1760
NSF STANDARD NO. 14

SCH. 40 PVC DWV FITTINGS

ASTM D 1784, ASTM D 2665, ASTM D 3311,
ASTM F1866
FHA UM 79a
FEDERAL SPECIFICATION L-P-320a
NSF STANDARD NO. 14

PVC PRESSURE PIPE SDR-21 AND SDR-26

ASTM D 1784, ASTM D 2241
NSF STANDARD NO. 14 AND 61

PVC SCH. 40 PRESSURE FITTINGS

ASTM D 1784, ASTM D 2466
NSF STANDARD 14 AND 61

PVC WELL CASING PIPE

ASTM D 1784, ASTM F 480
NSF STANDARD NO. 14 AND 61

PVC SCH. 80 PIPE

ASTM D 1784, ASTM D 1785
NSF STANDARD NO. 14 AND 61

PVC SCH. 80 FITTINGS

ASTM D 1784, ASTM D 2467
ASTM D 2464 ASTM F 1970
NSF STANDARD NO. 14 AND 61

PVC SEWER MAIN PIPE

ASTM D 1784, ASTM D 3034, SDR 35
ASTM D 3212, ASTM F 477

PVC SEWER AND DRAIN PIPE

ASTM D 1784, ASTM D 2729

PVC THIN WALL PIPE AND FITTINGS

ASTM D 1784, ASTM D 2949
NSF STANDARD NO. 14

CPVC CTS FLOWGUARD GOLD® PIPE & FITTINGS

ASTM D 1784, ASTM D 2846
FHA UM-61a
NSF STANDARD NO. 14 AND 61
CSA LISTED ON SPECIFIED ITEMS

CPVC CTS REUZE® PIPE & FITTINGS

ASTM D 1784, ASTM D 2846
NSF STANDARD NO. 14

CHEMDRAIN® CPVC SCHEDULE 40 PIPE AND FITTINGS

ASTM D 1784, ASTM F 2618
NSF STANDARD 14

SCH. 40 ABS DWV PIPE CELLULAR CORE

ASTM D 3965, ASTM F 628
NSF STANDARD NO. 14

SCH. 40 ABS DWV FITTINGS

ASTM D 3965, ASTM D 2661, ASTM D 3311
FHA UM 79a
FEDERAL SPECIFICATION L-P-322b
NSF STANDARD NO. 14

CHARLOTTE PIPE AND FOUNDRY COMPANY



Pipe Reference Guide



Product	Sizes Available																			
	1/4	3/8	1/2	3/4	1	1 1/4	1 1/2	2	2 1/2	3	4	5	6	8	10	12	14	15	16	
ChemDrain® CPVC Schedule 40 ★							●	●		●	●		●	●						
FlowGuard Gold® CPVC CTS SDR 11			●	●	●	●	●	●												
ReUze® CPVC CTS SDR 11			●	●	●		●	●												
PVC Schedule 80	●	●	●	●	●	●	●	●	●	●	●		●	●	●	●	●		●	
PVC Schedule 40			●	●	●	●	●	●	●	●	●	●	●	●	●	●	●		●	
PVC Schedule 40 DWV ★						●	●	●		●	●	●	●	●	●	●	●		●	
RePVC® Schedule 40 DWV with Recycled Content ★							●	●		●	●		●	●						
PVC Schedule 30 ★										●										
PVC DWV Foam Core ★							●	●		●	●		●	●	●	●				
PVC Well Casing							●	●	●	●			●	●						
PVC SDR 13.5 (PR315)			●																	
PVC SDR 21 (PR200)				●	●	●	●	●												
PVC SDR 26 (PR160)						●	●	●		●										
PVC SDR 35 Sewer Main Belled-End ★†											●		●							
PVC SDR 35 Sewer Main Gasketed ★†											●		●	●						
PVC D 2729 Sewer and Drain ★†											●	●								
ABS DWV Foam Core ★							●	●		●	●		●							

★ Non-Pressure

† Not NSF Listed

You can't beat the system.®

Notes:

1. End treatments are Plain and Belled. Consult factory for availability.
2. Lengths are 10 and 20 feet (14 and 20 feet for Gasketed Sewer Main). Consult factory for availability and non-standard lengths.
3. PVC Schedule 40 Bell End and PVC Well Casing pipe lengths for sizes 4", 6", and 8" are 20 feet plus the bell (20 foot laying length).
4. PVC SDR 35 Sewer Main Pipe in 14 foot lengths are 14 feet plus the bell (14 foot laying length).

ReUze, RePVC, ChemDrain and "You can't beat the system" are registered trademarks of Charlotte Pipe and Foundry Company.
FlowGuard Gold is a registered trademark of The Lubrizol Corp.

ABS Foam Core DWV Pipe



>> **ABS Schedule 40 DWV Pipe**

ABS SCHEDULE 40 FOAM CORE (BLACK)		PLAIN END	FOR NON-PRESSURE APPLICATIONS		ASTM F 628
PART NO.	NOM. SIZE	UPC # 611942-	AVG. OD (IN.)	MIN. WALL (IN.)	WT. PER 100 FT. (LBS.)
ABS 3112	1½" x 10'	03132	1.900	0.145	28.1
ABS 3112	1½" x 20'	03133	1.900	0.145	28.1
ABS 3200	2" x 10'	03134	2.375	0.154	37.7
ABS 3200	2" x 20'	03135	2.375	0.154	37.7
ABS 3300	3" x 10'	03136	3.500	0.216	77.9
ABS 3300	3" x 20'	03137	3.500	0.216	77.9
ABS 3400	4" x 10'	03138	4.500	0.237	111.4
ABS 3400	4" x 20'	03139	4.500	0.237	111.4
ABS 3600	6" x 10'	03140	6.625	0.280	196.2
ABS 3600	6" x 20'	03141	6.625	0.280	196.2

NSF Listed. Meets All Requirements of ASTM F 628.

NOTICE

NOT FOR PRESSURE

Do not use PVC / ABS cellular core (foam core) pipe for pressure applications. The use of cellular core pipe in pressure applications may result in system failure and property damage.

WARNING

Testing with or use of compressed air or gas in PVC / ABS / CPVC pipe or fittings can result in explosive failures and cause severe injury or death.

AIR/GAS

- NEVER test with or transport/store compressed air or gas in PVC / ABS / CPVC pipe or fittings.
- NEVER test PVC / ABS / CPVC pipe or fittings with compressed air or gas, or air over water boosters.
- ONLY use PVC / ABS / CPVC pipe for water or approved chemicals.
- Refer to warnings in PPFA User Bulletin 4-80 and ASTM D 1785.

RePVC[®] DWV Pipe

RePVC is a registered trademark of Charlotte Pipe and Foundry Company.



>> PVC Schedule 40 DWV Pipe with Recycled Content

PVC SCHEDULE 40 (WHITE)		PLAIN END FOR NON-PRESSURE APPLICATIONS				ASTM F 1760
PART NO.	NOM. SIZE	UPC # 611942-	QTY. PER SKID	AVG. OD (IN.)	MIN. WALL (IN.)	WT. PER 100 FT. (LBS.)
PVC 15112	1½" x 20'	11744	3440'	1.900	0.145	50.7
PVC 15200	2" x 20'	11745	1980'	2.375	0.154	68.1
PVC 15300	3" x 20'	11746	920'	3.500	0.216	141.2
PVC 15400	4" x 20'	11748	1200'	4.500	0.237	201.2
PVC 15600	6" x 20'	11749	560'	6.625	0.280	353.7
PVC 15800	8" x 20'	11984	360'	8.625	0.322	532.3

NSF Listed. Meets All Requirements of ASTM D 4396 and ASTM F 1760.

All products manufactured by Charlotte Pipe and Foundry Company are proudly made in the U.S.A.

NOTICE

NOT FOR PRESSURE

Do not use RePVC DWV pipe for pressure applications. The use of co-extruded DWV pipe in pressure applications may result in system failure and property damage.

WARNING

Testing with or use of compressed air or gas in PVC / ABS / CPVC pipe or fittings can result in explosive failures and cause severe injury or death.

AIR/GAS

- NEVER test with or transport/store compressed air or gas in PVC / ABS / CPVC pipe or fittings.
- NEVER test PVC / ABS / CPVC pipe or fittings with compressed air or gas, or air over water boosters.
- ONLY use PVC / ABS / CPVC pipe for water or approved chemicals.
- Refer to warnings in PPFA User Bulletin 4-80 and ASTM D 1785.

PVC Foam Core DWV Pipe



>> PVC Schedule 40 DWV Pipe

PVC SCHEDULE 40 FOAM CORE (WHITE)			PLAIN END	FOR NON-PRESSURE APPLICATIONS		ASTM F 891
PART NO.	NOM. SIZE	UPC # 611942-		AVG. OD (IN.)	MIN. WALL (IN.)	WT. PER 100 FT. (LBS.)
PVC 4112	1½" x 10'	04178		1.900	0.145	38.1
PVC 4112	1½" x 20'	04177		1.900	0.145	38.1
PVC 4200	2" x 10'	04174		2.375	0.154	51.2
PVC 4200	2" x 20'	04173		2.375	0.154	51.2
PVC 4300	3" x 10'	03934		3.500	0.216	105.0
PVC 4300	3" x 20'	03935		3.500	0.216	105.0
PVC 4400	4" x 10'	03936		4.500	0.237	146.0
PVC 4400	4" x 20'	03937		4.500	0.237	146.0
PVC 4600	6" x 10'	03938		6.625	0.280	247.0
PVC 4600	6" x 20'	03939		6.625	0.280	247.0
PVC 4800	8" x 20'	03941		8.625	0.322	371.0
PVC 4910	10" x 20'	03942		10.750	0.365	566.0
PVC 4912	12" x 20'	03943		12.750	0.406	755.0

PVC SCHEDULE 40 FOAM CORE (WHITE)			BELL-END	FOR NON-PRESSURE APPLICATIONS		
PART NO.	NOM. SIZE	UPC # 611942-		AVG. OD (IN.)	MIN. WALL (IN.)	WT. PER 100 FT. (LBS.)
PVC 4300B	3" x 20'	04782		3.500	0.216	105.0
PVC 4400B	4" x 10'	04783		4.500	0.237	146.0
PVC 4400B	4" x 20'	04784		4.500	0.237	146.0
PVC 4600B	6" x 20'	04786		6.625	0.280	247.0

NOTE: When ordering, please specify plain end or bell-end.

NSF Listed. Meets All Requirements of ASTM F 891.

NOTICE

NOT FOR PRESSURE

Do not use PVC / ABS cellular core (foam core) pipe for pressure applications. The use of cellular core pipe in pressure applications may result in system failure and property damage.

WARNING

Testing with or use of compressed air or gas in PVC / ABS / CPVC pipe or fittings can result in explosive failures and cause severe injury or death.

AIR/GAS

- NEVER test with or transport/store compressed air or gas in PVC / ABS / CPVC pipe or fittings.
- NEVER test PVC / ABS / CPVC pipe or fittings with compressed air or gas, or air over water boosters.
- ONLY use PVC / ABS / CPVC pipe for water or approved chemicals.
- Refer to warnings in PPFA User Bulletin 4-80 and ASTM D 1785.

PVC Schedule 40 DWV Pipe



>> PVC Schedule 40 DWV Pipe

PVC SCHEDULE 40 (WHITE)		PLAIN END	PVC 1120	ASTM D 2665	
PART NO.	NOM. SIZE	UPC # 611942-	AVG. OD (IN.)	MIN. WALL (IN.)	WT. PER 100 FT. (LBS.)
PVC 7100*	1¼" x 10'	03945	1.660	.140	42.4
PVC 7100*	1¼" x 20'	03946	1.660	.140	42.4
PVC 7112*	1½" x 10'	03947	1.900	.145	50.7
PVC 7112*	1½" x 20'	03948	1.900	.145	50.7
PVC 7200*	2" x 10'	03949	2.375	.154	68.1
PVC 7200*	2" x 20'	03950	2.375	.154	68.1
PVC 7300*	3" x 10'	03951	3.500	.216	141.2
PVC 7300*	3" x 20'	03952	3.500	.216	141.2
PVC 7400†	4" x 10'	03953	4.500	.237	201.2
PVC 7400†	4" x 20'	03954	4.500	.237	201.2
PVC 7500†	5" x 20'	04837	5.563	.258	272.5
PVC 7600†	6" x 10'	03955	6.625	.280	353.7
PVC 7600†	6" x 20'	03956	6.625	.280	353.7
PVC 7800†	8" x 20'	03958	8.625	.322	532.3
PVC 7910†	10" x 20'	03959	10.750	.365	754.7
PVC 7912†	12" x 20'	03961	12.750	.406	997.9
PVC 7914†	14" x 20'	04862	14.000	.437	1180.1
PVC 7916†	16" x 20'	04918	16.000	.500	1543.1

* Dual Marked ASTM D 1785 & ASTM D 2665.

† Triple Marked ASTM D 1785 & ASTM D 2665 & ASTM F 480

NSF Listed. Meets All Requirements of ASTM D 1784, ASTM D 1785, and ASTM D 2665.

WARNING

Testing with or use of compressed air or gas in PVC / ABS / CPVC pipe or fittings can result in explosive failures and cause severe injury or death.

AIR/GAS

- NEVER test with or transport/store compressed air or gas in PVC / ABS / CPVC pipe or fittings.
- NEVER test PVC / ABS / CPVC pipe or fittings with compressed air or gas, or air over water boosters.
- ONLY use PVC / ABS / CPVC pipe for water or approved chemicals.
- Refer to warnings in PPFA User Bulletin 4-80 and ASTM D 1785.

PVC Pipe: Schedule 40



>> PVC Schedule 40 Pipe - Plain End

PVC SCHEDULE 40 (WHITE)		PLAIN END		PVC 1120	ASTM D 1785	
PART NO.	NOM. SIZE	UPC # 611942-	AVG. OD (IN.)	MIN. WALL (IN.)	MAX WORK PRESSURE AT 23° C OR 73° F	WT. PER 100 FT. (LBS.)
PVC 4005	1/2" x 10'	06658	.840	.109	600 PSI	15.9
PVC 4005	1/2" x 20'	03922	.840	.109	600 PSI	15.9
PVC 4007	3/4" x 10'	06661	1.050	.113	480 PSI	21.1
PVC 4007	3/4" x 20'	03925	1.050	.113	480 PSI	21.1
PVC 4010	1" x 10'	06664	1.315	.133	450 PSI	31.3
PVC 4010	1" x 20'	03928	1.315	.133	450 PSI	31.3
PVC 7100*	1 1/4" x 10'	03945	1.660	.140	370 PSI	42.4
PVC 7100*	1 1/4" x 20'	03946	1.660	.140	370 PSI	42.4
PVC 7112*	1 1/2" x 10'	03947	1.900	.145	330 PSI	50.7
PVC 7112*	1 1/2" x 20'	03948	1.900	.145	330 PSI	50.7
PVC 7200*	2" x 10'	03949	2.375	.154	280 PSI	68.1
PVC 7200*	2" x 20'	03950	2.375	.154	280 PSI	68.1
PVC 4025‡	2 1/2" x 20'	04205	2.875	.203	300 PSI	108.0
PVC 7300*	3" x 10'	03951	3.500	.216	260 PSI	141.2
PVC 7300*	3" x 20'	03952	3.500	.216	260 PSI	141.2
PVC 7400†	4" x 10'	03953	4.500	.237	220 PSI	201.2
PVC 7400†	4" x 20'	03954	4.500	.237	220 PSI	201.2
PVC 7500†	5" x 20'	04837	5.563	.258	190 PSI	272.5
PVC 7600†	6" x 10'	03955	6.625	.280	180 PSI	353.7
PVC 7600†	6" x 20'	03956	6.625	.280	180 PSI	353.7
PVC 7800†	8" x 20'	03958	8.625	.322	160 PSI	532.3
PVC 7910†	10" x 20'	03959	10.750	.365	140 PSI	754.7
PVC 7912†	12" x 20'	03961	12.750	.406	130 PSI	997.9
PVC 7914†	14" x 20'	04862	14.000	.437	130 PSI	1180.1
PVC 7916†	16" x 20'	04918	16.000	.500	130 PSI	1543.1

* Dual Marked ASTM D 1785 and ASTM D 2665.

† Triple Marked ASTM D 1785 & ASTM D 2665 & ASTM F 480.

‡ Dual Marked ASTM D 1785 & ASTM F 480.

NOTE: When ordering, please specify plain end or bell end.

NSF Listed. Meets All Requirements of ASTM D 1784 and ASTM D 1785.

WARNING

Testing with or use of compressed air or gas in PVC / ABS / CPVC pipe or fittings can result in explosive failures and cause severe injury or death.

AIR/GAS

- NEVER test with or transport/store compressed air or gas in PVC / ABS / CPVC pipe or fittings.
- NEVER test PVC / ABS / CPVC pipe or fittings with compressed air or gas, or air over water boosters.
- ONLY use PVC / ABS / CPVC pipe for water or approved chemicals.
- Refer to warnings in PPFA User Bulletin 4-80 and ASTM D 1785.

PRODUCT DATA

>> PVC Schedule 40 Pipe - Bell End*

PVC SCHEDULE 40 (WHITE)			BELL END		PVC 1120	ASTM D 1785	
PART NO.	NOM. SIZE	UPC # 611942-	AVG. OD (IN.)	MIN. WALL (IN.)	MAX WORK PRESSURE AT 23° C OR 73° F	BELL DEPTH (IN.)	WT. PER 100 FT. (LBS.)
PVC 4005B**	½" x 10'	04986	.840	.109	600 PSI	2.00	15.9
PVC 4005B**	½" x 20'	03923	.840	.109	600 PSI	2.00	15.9
PVC 4007B**	¾" x 10'	04987	1.050	.113	480 PSI	2.25	21.1
PVC 4007B**	¾" x 20'	03926	1.050	.113	480 PSI	2.25	21.1
PVC 4010B**	1" x 10'	04988	1.315	.133	450 PSI	2.50	31.3
PVC 4010B**	1" x 20'	03929	1.315	.133	450 PSI	2.50	31.3
PVC 4012B§	1¼" x 10'	04989	1.660	.140	370 PSI	2.75	42.4
PVC 4012B§	1¼" x 20'	03930	1.660	.140	370 PSI	2.75	42.4
PVC 4015B§	1½" x 10'	04990	1.900	.145	330 PSI	3.00	50.7
PVC 4015B§	1½" x 20'	03931	1.900	.145	330 PSI	3.00	50.7
PVC 4020B†	2" x 10'	04991	2.375	.154	280 PSI	4.00	69.2
PVC 4020B†	2" x 20'	03932	2.375	.154	280 PSI	4.00	69.2
PVC 4025B‡	2½" x 10'	04992	2.875	.203	300 PSI	4.00	110.0
PVC 4025B‡	2½" x 20'	04206	2.875	.203	300 PSI	4.00	110.0
PVC 7300B§	3" x 10'	04853	3.500	.216	260 PSI	4.00	145.1
PVC 4030B†	3" x 20'	03933	3.500	.216	260 PSI	4.00	144.5
PVC 7400B§	4" x 10'	04835	4.500	.237	220 PSI	4.00	207.9
PVC 9400B†	4" x 20'	03964	4.500	.237	220 PSI	5.00	206.2
PVC 7600B§	6" x 10'	04850	6.625	.280	180 PSI	6.50	371.4
PVC 9600B†	6" x 20'	03965	6.625	.280	180 PSI	6.50	365.5
PVC 7800B†	8" x 10'	09903	8.625	.322	160 PSI	7.00	532.3
PVC 9800B†	8" x 20'	03967	8.625	.322	160 PSI	7.00	552.3
PVC 7910B†	10" x 20'	03960	10.750	.365	140 PSI	9.00	785.4
PVC 7912B†	12" x 20'	03962	12.750	.406	130 PSI	10.00	1046.7
PVC 7914B†	14" x 20'	04863	14.000	.437	130 PSI	10.00	1180.1
PVC 7916B†	16" x 20'	04929	16.000	.500	130 PSI	10.00	1543.1

* Bell dimensions meet either ASTM D 2672 or ASTM F 480, depending upon pipe diameter

** ASTM D 1785

§ Dual Marked ASTM D 1785 & ASTM D 2665

† Triple Marked ASTM D 1785 & ASTM D 2665 & ASTM F 480

‡ Dual Marked ASTM D 1785 & ASTM F 480

WARNING

Testing with or use of compressed air or gas in PVC / ABS / CPVC pipe or fittings can result in explosive failures and cause severe injury or death.

AIR/GAS

- NEVER test with or transport/store compressed air or gas in PVC / ABS / CPVC pipe or fittings.
- NEVER test PVC / ABS / CPVC pipe or fittings with compressed air or gas, or air over water boosters.
- ONLY use PVC / ABS / CPVC pipe for water or approved chemicals.
- Refer to warnings in PPFA User Bulletin 4-80 and ASTM D 1785.

PRODUCT DATA

>> PVC Well Casing

PVC SCHEDULE 40 (WHITE)		BELL END WELL CASING		PVC 1120		ASTM F 480
PART NO.	NOM. SIZE	UPC # 611942-	AVG. OD (IN.)	MIN. WALL (IN.)	BELL DEPTH (IN.)	WT. PER 100 FT. (LBS.)
PVC 4020B	2" x 20'	03932	2.375	.154	4.00	69.2
PVC 4025B	2½" x 20'	04206	2.875	.203	4.00	110.0
PVC 4030B	3" x 20'	03933	3.500	.216	4.00	144.5
PVC 9400B	4" x 20'	03964	4.500	.237	5.00	206.2
PVC 9600B	6" x 20'	03965	6.625	.280	6.50	365.5
PVC 9800B	8" x 20'	03967	8.625	.322	7.00	552.3

>> PVC SDR Pipe

PR 200	PVC 1120	BELL END		ASTM D 2241		SDR 21	
PART NO.	NOM. SIZE	UPC # 611942-	AVG. OD (IN.)	MIN. WALL (IN.)	MAX WORK PRESSURE AT 23° C OR 73° F	BELL DEPTH (IN.)	WT. PER 100 FT. (LBS.)
PVC 23155B	*1½" x 20'	03991	.840	.062	315 PSI	2.00	10.0
PVC 20007B	¾" x 10'	10742	1.050	.060	200 PSI	2.25	11.8
PVC 20007B	¾" x 20'	03984	1.050	.060	200 PSI	2.25	11.8
PVC 20010B	1" x 20'	03986	1.315	.063	200 PSI	2.50	15.7
PVC 20012B	1¼" x 20'	03987	1.660	.079	200 PSI	2.75	24.9
PVC 20015B	1½" x 20'	03988	1.900	.090	200 PSI	3.00	32.4
PVC 20020B	2" x 20'	03989	2.375	.113	200 PSI	4.00	50.9

*PR 315 / SDR 13.5

PR 160	PVC 1120	BELL END		ASTM D 2241		SDR 26	
PART NO.	NOM. SIZE	UPC # 611942-	AVG. OD (IN.)	MIN. WALL (IN.)	MAX WORK PRESSURE AT 23° C OR 73° F	BELL DEPTH (IN.)	WT. PER 100 FT. (LBS.)
PVC 16012B	1¼" x 20'	04211	1.660	.064	160 PSI	2.75	20.3
PVC 16015B	1½" x 20'	04210	1.900	.073	160 PSI	3.00	26.6
PVC 16020B	2" x 20'	04212	2.375	.091	160 PSI	4.00	41.4
PVC 16030B	3" x 20'	04222	3.500	.135	160 PSI	4.00	92.3

NOTE: When ordering, please specify plain end or bell end.



⚠ WARNING

Testing with or use of compressed air or gas in PVC / ABS / CPVC pipe or fittings can result in explosive failures and cause severe injury or death.

AIR/GAS

- NEVER test with or transport/store compressed air or gas in PVC / ABS / CPVC pipe or fittings.
- NEVER test PVC / ABS / CPVC pipe or fittings with compressed air or gas, or air over water boosters.
- ONLY use PVC / ABS / CPVC pipe for water or approved chemicals.
- Refer to warnings in PPSA User Bulletin 4-80 and ASTM D 1785.

FlowGuard Gold[®] Pipe

>> CPVC Copper Tube Size Pipe



STRAIGHT LENGTHS			PLAIN END SDR 11 CPVC COPPER TUBE SIZE PIPE				ASTM D 2846		
PART NO.	NOM. SIZE	UPC # 611942-	QTY. PER BUNDLE	TRUCKLOAD PERCENT PER SKID	QTY. PER SKID	AVG. OD (IN.)	MIN. WALL (IN.)	MAX WORK PRESSURE AT 23° C OR 73° F	WT. PER 100 FT. (LBS.)
CTS 12005	½" x 10'	04979	500'	2.083	12,000'	.625	.068	400 PSI	8.3
CTS 12005	½" x 20'	04993	1,000'	5.000	24,000'	.625	.068	400 PSI	8.3
CTS 12007	¾" x 10'	04980	250'	2.083	6,000'	.875	.080	400 PSI	13.9
CTS 12007	¾" x 20'	05145	500'	5.000	12,000'	.875	.080	400 PSI	13.9
CTS 12010	1" x 10'	05146	150'	2.083	3,600'	1.125	.102	400 PSI	22.2
CTS 12010	1" x 20'	05147	300'	5.000	7,200'	1.125	.102	400 PSI	22.2
CTS 12012	1¼" x 10'	05148	100'	2.083	2,400'	1.375	.125	400 PSI	33.3
CTS 12012	1¼" x 20'	05321	200'	5.000	4,800'	1.375	.125	400 PSI	33.3
CTS 12015	1½" x 10'	05150	60'	2.083	1,440'	1.625	.148	400 PSI	46.6
CTS 12015	1½" x 20'	05306	120'	5.000	2,880'	1.625	.148	400 PSI	46.6
CTS 12020	2" x 10'	05152	40'	2.083	960'	2.125	.193	400 PSI	79.5
CTS 12020	2" x 20'	05322	80'	5.000	1,920'	2.125	.193	400 PSI	79.5

NOTE: STRAIGHT LENGTH PIPE ARE SHIPPED IN FULL BUNDLE QUANTITY ONLY.

COILED PIPE SDR 11			COILED SDR CPVC COPPER TUBE SIZE PIPE				ASTM D 2846		
PART NO.	NOM. SIZE	UPC # 611942-	QTY. PER BUNDLE	TRUCKLOAD PERCENT PER SKID	QTY. PER SKID	AVG. OD (IN.)	MIN. WALL (IN.)	PRESSURE AT 23° C OR 73° F	MAX WORK WT. PER 100 FT. (LBS.)
CTS 12005	½" x 150'	05313	150'	4.166	3,750'	.625	.068	400 PSI	8.5
CTS 12007	¾" x 100'	05314	100'	4.166	2,500'	.875	.080	400 PSI	14.0
CTS 12010	1" x 100'	10643	100'	4.166	1,200'	1.125	.102	400 PSI	22.2

NSF Listed. Meets All Requirements of ASTM D 2846.

⚠ WARNING

Testing with or use of compressed air or gas in PVC / ABS / CPVC pipe or fittings can result in explosive failures and cause severe injury or death.

AIR/GAS

- NEVER test with or transport/store compressed air or gas in PVC / ABS / CPVC pipe or fittings.
- NEVER test PVC / ABS / CPVC pipe or fittings with compressed air or gas, or air over water boosters.
- ONLY use PVC / ABS / CPVC pipe for water or approved chemicals.
- Refer to warnings in PPFA User Bulletin 4-80 and ASTM D 1785.

ReUze[®] Pipe

ReUze is a registered trademark of Charlotte Pipe and Foundry Company.



>> CPVC Copper-Tube-Size Pipe for Non-Potable Water Distribution

STRAIGHT LENGTHS		PLAIN END SDR 11 CPVC COPPER TUBE SIZE PIPE						ASTM D 2846	
PART NO.	NOM. SIZE	UPC # 611942-	QTY. PER BUNDLE	TRUCKLOAD PERCENT PER SKID	QTY. PER SKID	AVG. OD (IN.)	MIN. WALL (IN.)	PRESSURE AT 23° C OR 73° F	MAX WORK WT. PER 100 FT. (LBS.)
CTS 12005 RU	½" x 20'	11642	1,000'	5.000	24,000'	.625	.068	400 PSI	8.3
CTS 12007 RU	¾" x 20'	11643	500'	5.000	12,000'	.875	.080	400 PSI	13.9
CTS 12010 RU	1" x 20'	11644	300'	5.000	7,200'	1.125	.102	400 PSI	22.2
CTS 12015 RU	1½" x 20'	11645	120'	5.000	2,880'	1.625	.148	400 PSI	46.6
CTS 12020 RU	2" x 20'	11646	80'	5.000	1,920'	2.125	.193	400 PSI	79.5

NOTE: STRAIGHT LENGTH PIPE ARE SHIPPED IN FULL BUNDLE QUANTITY ONLY.

NSF Listed. Meets All Requirements of ASTM D 2846.

⚠ WARNING

Testing with or use of compressed air or gas in PVC / ABS / CPVC pipe or fittings can result in explosive failures and cause severe injury or death.

AIR/GAS

- NEVER test with or transport/store compressed air or gas in PVC / ABS / CPVC pipe or fittings.
- NEVER test PVC / ABS / CPVC pipe or fittings with compressed air or gas, or air over water boosters.
- ONLY use PVC / ABS / CPVC pipe for water or approved chemicals.
- Refer to warnings in PPFA User Bulletin 4-80 and ASTM D 1785.

PVC Schedule 80 Pipe



>> PVC Schedule 80 Pipe, Type 1, Grade 1 - Plain End

ASTM D 1784 & ASTM D 1785

PVC SCHEDULE 80 (GRAY)			PLAIN END			PVC 1120
PART NO.	NOM. SIZE	UPC # 611942-	AVG. OD (IN.)	MIN. WALL (IN.)	MAX WORK PRESSURE AT 23° C OR 73° F	WT. PER 100 FT. (LBS.)
PVC 10002	¼" x 20'	04920	0.540	.119	1130 PSI	10.0
PVC 10003	⅜" x 20'	04917	0.675	.126	920 PSI	13.8
PVC 10005	½" x 20'	03968	0.840	.147	850 PSI	20.3
PVC 10007	¾" x 20'	03969	1.050	.154	690 PSI	27.5
PVC 10010	1" x 20'	03970	1.315	.179	630 PSI	40.5
PVC 10012	1¼" x 20'	03973	1.660	.191	520 PSI	55.9
PVC 10015	1½" x 20'	03976	1.900	.200	470 PSI	67.7
PVC 10020	2" x 20'	03977	2.375	.218	400 PSI	93.6
PVC 10025	2½" x 20'	03978	2.875	.276	420 PSI	142.8
PVC 10030	3" x 20'	03979	3.500	.300	370 PSI	191.1
PVC 10040	4" x 20'	03980	4.500	.337	320 PSI	279.3
PVC 10050	5" x 20'	04831	5.563	.375	290 PSI	387.3
PVC 10060	6" x 20'	03981	6.625	.432	280 PSI	532.7
PVC 10080	8" x 20'	04175	8.625	.500	250 PSI	808.9
PVC 10100	10" x 20'	04768	10.750	.593	230 PSI	1199.3
PVC 10120	12" x 20'	04770	12.750	.687	230 PSI	1650.1
PVC 10140	14" x 20'	04816	14.000	.750	220 PSI	1930.0
PVC 10160	16" x 20'	04919	16.000	.843	220 PSI	2544.1

NSF Listed. Meets All Requirements of ASTM D 1784 and ASTM D 1785.

WARNING

Testing with or use of compressed air or gas in PVC / ABS / CPVC pipe or fittings can result in explosive failures and cause severe injury or death.

AIR/GAS

- NEVER test with or transport/store compressed air or gas in PVC / ABS / CPVC pipe or fittings.
- NEVER test PVC / ABS / CPVC pipe or fittings with compressed air or gas, or air over water boosters.
- ONLY use PVC / ABS / CPVC pipe for water or approved chemicals.
- Refer to warnings in PPFA User Bulletin 4-80 and ASTM D 1785.

PVC Schedule 80 Pipe



>> PVC Schedule 80 Pipe, Type 1, Grade 1 - Belled End

ASTM D 1784 & ASTM D 1785

PVC SCHEDULE 80 (GRAY)			BELLED-END		PVC 1120	
PART NO.	NOM. SIZE	UPC # 611942-	AVG. OD (IN.)	MIN. WALL (IN.)	MAX WORK PRESSURE AT 23° C OR 73° F	WT. PER 100 FT. (LBS.)
PVC 10005B	½" x 20'	04924	0.840	.147	850 PSI	20.3
PVC 10007B	¾" x 20'	04925	1.050	.154	690 PSI	27.5
PVC 10010B	1" x 20'	04926	1.315	.179	630 PSI	40.5
PVC 10012B	1¼" x 20'	04927	1.660	.191	520 PSI	55.9
PVC 10015B	1½" x 20'	04928	1.900	.200	470 PSI	67.7
PVC 10020B	2" x 20'	04764	2.375	.218	400 PSI	93.6
PVC 10025B	2½" x 20'	04875	2.875	.276	420 PSI	142.8
PVC 10030B	3" x 20'	04776	3.500	.300	370 PSI	191.1
PVC 10040B	4" x 20'	04774	4.500	.337	320 PSI	279.3
PVC 10060B	6" x 20'	04763	6.625	.432	280 PSI	532.7
PVC 10080B	8" x 20'	04766	8.625	.500	250 PSI	808.9
PVC 10100B	10" x 20'	04769	10.750	.593	230 PSI	1199.3
PVC 10120B	12" x 20'	04771	12.750	.687	230 PSI	1650.1
PVC 10140B	14" x 20'	04832	14.000	.750	220 PSI	1930.0
PVC 10160B	16" x 20'	09372	16.000	.843	220 PSI	2544.1

NSF Listed. Meets All Requirements of ASTM D 1784 and ASTM D 1785.

WARNING

Testing with or use of compressed air or gas in PVC / ABS / CPVC pipe or fittings can result in explosive failures and cause severe injury or death.

AIR/GAS

- NEVER test with or transport/store compressed air or gas in PVC / ABS / CPVC pipe or fittings.
- NEVER test PVC / ABS / CPVC pipe or fittings with compressed air or gas, or air over water boosters.
- ONLY use PVC / ABS / CPVC pipe for water or approved chemicals.
- Refer to warnings in PPFA User Bulletin 4-80 and ASTM D 1785.

Socket Dimensions For Belled-End Pipe

NOM. Pipe size	ASTM Standard	SOCKET ENTRANCE (A)		SOCKET BOTTOM (B)		SOCKET LENGTH (C)		
		I.D. Min.	I.D. Max.	I.D. Min.	I.D. Max.	SDR	Schedule 40	Schedule 80
½	D 2672	.844	0.852	0.832	0.840	2.000	2.000	1.000
¾	D 2672	1.054	1.062	1.042	1.050	2.250	2.250	1.250
1	D 2672	1.320	1.330	1.305	1.315	2.500	2.500	1.500
1¼	D 2672	1.665	1.675	1.650	1.660	2.750	2.750	1.750
1½	D 2672	1.906	1.918	1.888	1.900	3.000	3.000	2.000
2	D 2672	2.381	2.393	2.357	2.369	4.000	—	2.250
2	F 480	2.380	2.392	2.357	2.369	—	4.000	—
2½	D 2672	2.882	2.896	2.854	2.868	4.000	—	2.500
2½	F 480	2.880	2.894	2.854	2.868	—	4.000	—
3	D 2672	3.508	3.524	3.476	3.492	4.000	—	3.250
3	F 480	3.506	3.522	3.476	3.492	—	4.000	—
4	D 2672	4.509	4.527	4.473	4.491	5.000	—	4.000
4	F 480	4.508	4.526	4.473	4.491	—	5.000	—
6	D 2672	6.636	6.658	6.592	6.614	6.500	—	6.000
6	F 480	6.637	6.659	6.592	6.614	—	6.500	—
8	D 2672	8.640	8.670	8.583	8.613	—	—	6.000
8	F 480	8.634	8.664	8.583	8.613	—	7.000	—
10	D 2672	10.761	10.791	10.707	10.737	—	9.000	7.500
12	D 2672	12.763	12.793	12.706	12.736	—	10.000	8.500
14	D 2672	14.020	14.050	13.970	14.000	—	10.000	9.000
16	D 2672	16.030	16.060	15.965	15.995	—	10.000	10.000

Note: All dimensions are in inches.

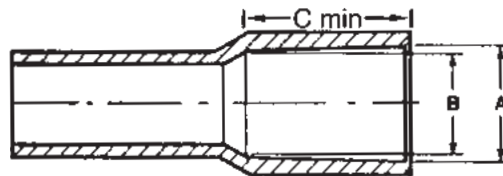

CPVC Schedule 80 Pipe



>> * **CORZAN** CPVC Schedule 80 Pipe, Type IV, Grade 1

ASTM D 1784 & ASTM F 441

CPVC SCHEDULE 80 (LIGHT GRAY)			PLAIN END		CPVC 4120	
PART NO.	NOM. SIZE	UPC # 611942-	AVG. OD (IN.)	MIN. WALL (IN.)	MAX WORK PRESSURE AT 23° C OR 73° F	WT. PER 100 FT. (LBS.)
CPV 11005	½" x 20'	04787	.840	.147	850 PSI	22.1
CPV 11007	¾" x 20'	04788	1.050	.154	690 PSI	30.0
CPV 11010	1" x 20'	04789	1.315	.179	630 PSI	44.2
CPV 11012	1¼" x 20'	04790	1.660	.191	520 PSI	61.0
CPV 11015	1½" x 20'	04791	1.900	.200	470 PSI	73.9
CPV 11020	2" x 20'	04792	2.375	.218	400 PSI	102.2
CPV 11025	2½" x 20'	04793	2.875	.276	420 PSI	155.9
CPV 11030	3" x 20'	04794	3.500	.300	370 PSI	208.6
CPV 11040	4" x 20'	04795	4.500	.337	320 PSI	304.9
CPV 11060	6" x 20'	04796	6.625	.432	280 PSI	581.5
CPV 11080	8" x 20'	04797	8.625	.500	250 PSI	882.9

* Note: This product is not currently available. Information provided is for reference only.

NSF Listed. Meets All Requirements of ASTM D 1784 and ASTM F 441.

Corzan is a registered trademark of The Lubrizol Corporation.

WARNING

Testing with or use of compressed air or gas in PVC / ABS / CPVC pipe or fittings can result in explosive failures and cause severe injury or death.

AIR/GAS

- NEVER test with or transport/store compressed air or gas in PVC / ABS / CPVC pipe or fittings.
- NEVER test PVC / ABS / CPVC pipe or fittings with compressed air or gas, or air over water boosters.
- ONLY use PVC / ABS / CPVC pipe for water or approved chemicals.
- Refer to warnings in PPFA User Bulletin 4-80 and ASTM D 1785.

PVC Sewer Pipe

>> PVC SDR 35 PSM Pipe

ASTM D 3034 & ASTM F 477

SDR-35		GASKETED - PS 46						
PART NO.	NOM. SIZE	UPC # 611942-	QTY. PER SKID	TRUCKLOAD PERCENT PER SKID	LAYING LENGTH	WT. PER 100 FT. (LBS.)	AVG. OD (IN.)	MIN. WALL (IN.)
S/M 6004G	4" x 14'	11920	840	5.556	14'-0"	110.4	4.215	.120
S/M 6004G	4" x 20'	04012	1200	7.144	20'-0"	109.7	4.215	.120
S/M 6006G	6" x 14'	11921	392	5.556	14'-0"	249.6	6.275	.180
S/M 6006G	6" x 20'	04016	560	8.330	20'-0"	247.0	6.275	.180
S/M 6008G	8" x 14'	11922	140	3.333	14'-0"	451.0	8.400	.240

Weight is approximate and is for shipping purposes only.

SDR-35		SOLVENT WELD - PS 46						
PART NO.	NOM. SIZE	UPC # 611942-	QTY. PER SKID	TRUCKLOAD PERCENT PER SKID	LAYING LENGTH	WT. PER 100 FT. (LBS.)	AVG. OD (IN.)	MIN. WALL (IN.)
S/M 6004	4" x 10'	04008	600	4.160	10'-0"	112.0	4.215	.120
S/M 6004	4" x 20'	04009	1200	7.144	20'-0"	109.7	4.215	.120
S/M 6006	6" x 10'	04013	280	4.160	10'-0"	252.0	6.275	.180
S/M 6006	6" x 20'	04014	560	8.330	20'-0"	246.0	6.275	.180

Weight is approximate and is for shipping purposes only.

NOTE: For truckloads of mixed sizes, multiply skids desired by truckload percent per skid.

Meets All Requirements of ASTM D 3034.

SDR 35 Gaskets meet or exceed ASTM F 477.

Gasketed joints meet ASTM D 3212.

NOTICE

NOT FOR PRESSURE

Do not use PVC Sewer pipe for pressure applications. The use of sewer pipe in pressure applications may result in system failure and property damage.

WARNING

Testing with or use of compressed air or gas in PVC / ABS / CPVC pipe or fittings can result in explosive failures and cause severe injury or death.

AIR/GAS



- NEVER test with or transport/store compressed air or gas in PVC / ABS / CPVC pipe or fittings.
- NEVER test PVC / ABS / CPVC pipe or fittings with compressed air or gas, or air over water boosters.
- ONLY use PVC / ABS / CPVC pipe for water or approved chemicals.
- Refer to warnings in PPFA User Bulletin 4-80 and ASTM D 1785.

PVC Sewer and Drain Pipe

>> **PVC ASTM D 2729 Pipe**

SOLVENT WELD BELLED END								ASTM D 2729	
PART NO.	NOM. SIZE	UPC # 611942-	QTY. PER SKID	TRUCKLOAD PERCENT PER SKID	AVG. OD (IN.)	MIN. WALL (IN.)	BELL DEPTH (IN.)	WT. PER 100 FT. (LBS.)	LIST PRICE PER 100 FT.
PVC 30030	3" x 10'	10903	810'	3.125	3.250	0.070	1.50	52.8	\$ 110.00
PVC 30040	4" x 10'	10905	500'	3.125	4.215	0.075	1.75	70.4	\$ 130.00

>> **Perforated PVC ASTM D 2729 Pipe**

SOLVENT WELD BELLED END								ASTM D 2729	
PART NO.	NOM. SIZE	UPC # 611942-	QTY. PER SKID	TRUCKLOAD PERCENT PER SKID	AVG. OD (IN.)	MIN. WALL (IN.)	BELL DEPTH (IN.)	WT. PER 100 FT. (LBS.)	LIST PRICE PER 100 FT.
PVC 30030P	3" x 10'	11814	1040'	4.160	3.250	0.070	1.50	52.8	\$ 110.00
PVC 30040P	4" x 10'	11815	500'	3.125	4.215	0.075	1.75	70.4	\$ 130.00

Perforated pipe is supplied with two rows of 1/2" diameter holes every five inches. Rows are parallel to the pipe axis and are 120° apart.

Weight is approximate and is for shipping purposes only.

NOTE: For truckloads of mixed sizes, multiply skids desired by truckload percent per skid.

Pipe listed in this section meets or exceeds the requirements of ASTM D 2729.

NOTICE

NOT FOR PRESSURE

Do not use PVC Sewer pipe for pressure applications. The use of sewer pipe in pressure applications may result in system failure and property damage.

WARNING

Failure to follow safety precautions may result in misapplication or improper installation and testing which can cause severe personal injury and / or property damage. **Primers and cements are extremely flammable and may be explosive. Do not store or use near heat or open flame, or death or serious injury may occur.**

- Solvent fumes created during the joining process are heavier than air and may be trapped in newly installed piping systems.
- Ignition of the solvent vapors caused by spark or flame may result in injury or death from explosion or fire.
- Read and obey all manufacturers' warnings and any instructions pertaining to primers and cements.
- Provide adequate ventilation to reduce fire hazard and to minimize inhalation of solvent vapors when working with cements, primers and new piping systems.

FlowGuard Gold® and ReUze® CTS CPVC ASTM D 2846 Dimensions and Tolerances

FlowGuard Gold CTS CPVC pipe and fittings used in potable water systems and ReUze® CTS CPVC pipe and fittings used in non-potable water systems are manufactured to the dimensions and specifications shown in ASTM D 2846. This product is tan in color, and the pipe has the same outside diameter as copper tubing. Pipe up through nominal 2" size is manufactured to a standard dimension ratio (SDR) of 11. The standard dimension ratio represents the ratio of the pipe O.D. to the pipe wall thickness. Consequently, all of the SDR 11 CPVC sizes have the same pressure rating.

Outside Diameters, Wall Thicknesses and Tolerances CPVC 4120, SDR 11 Plastic Pipe, in inches

Nominal Size	Average Pipe O.D.	Tolerance on Average O.D.	Wall Thickness	Tolerance on Wall
½	0.625	±0.003	0.068	+0.020
¾	0.875	±0.003	0.080	+0.020
1	1.125	±0.003	0.102	+0.020
1¼	1.375	±0.003	0.125	+0.020
1½	1.625	±0.003	0.148	+0.020
2	2.125	±0.004	0.193	+0.023

Tapered Socket Dimensions and Tolerances

Tapered Socket Dimensions CPVC 4120, SDR 11, Plastic Fittings, in inches

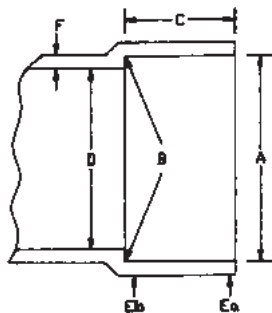

Nominal Size	Socket Entrance (A) I.D.	Socket Bottom (B) I.D.	I.D. Tolerance	(C) Min.	(D) Min.	(E _a) Min.	(E _b) Min.	(F) Min.
½	0.633	0.619	±0.003	0.500	0.489	0.068	0.102	0.128
¾	0.884	0.870	±0.003	0.700	0.715	0.080	0.102	0.128
1	1.135	1.121	±0.003	0.900	0.921	0.102	0.102	0.128
1¼	1.386	1.372	±0.003	1.100	1.125	0.125	0.125	0.156
1½	1.640	1.622	±0.004	1.300	1.329	0.148	0.148	0.185
2	2.141	2.123	±0.004	1.700	1.739	0.193	0.193	0.241

PRODUCT DATA

ASTM D 2846
Standard Specifications
for
FLOWGUARD GOLD®
CPVC
PIPE AND FITTINGS
for
HOT- AND COLD-WATER
DISTRIBUTION SYSTEMS



Outside Diameters and Wall Thickness For CPVC 41, SDR 11 Plastic Pipe

Nominal Size (in.)	Outside Diameter, In. (mm)		Wall Thickness, In. (mm)	
	Average	Tolerance	Minimum	Tolerance
1/2	0.625 (15.9)	± 0.003 (± 0.08)	0.068 (1.73)	+ 0.020 (+ 0.51)
3/4	0.875 (22.2)	± 0.003 (± 0.08)	0.080 (2.03)	+ 0.020 (+ 0.51)
1	1.125 (28.6)	± 0.003 (± 0.08)	0.102 (2.59)	+ 0.020 (+ 0.51)
1 1/4	1.375 (34.9)	± 0.003 (± 0.08)	0.125 (3.18)	+ 0.020 (+ 0.51)
1 1/2	1.625 (41.3)	± 0.004 (± 0.10)	0.148 (3.76)	+ 0.020 (+ 0.51)
2	2.125 (54.0)	± 0.004 (± 0.10)	0.193 (4.90)	+ 0.023 (+ 0.58)

Tapered Socket Dimensions For CPVC 41, SDR 11 Plastic Fittings

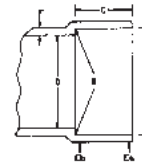

Nominal Size (in.)	Socket Entrance Diameter, In. (mm)		Socket Bottom Diameter, In. (mm)	
	"A" Average	"A" Tolerance	"B" Average	"B" Tolerance
1/2	0.633 (16.08)	± 0.003 (± 0.08)	0.619 (15.72)	± 0.003 (± 0.08)
3/4	0.884 (22.45)	± 0.003 (± 0.08)	0.870 (22.10)	± 0.003 (± 0.08)
1	1.135 (28.83)	± 0.003 (± 0.08)	1.121 (28.47)	± 0.003 (± 0.08)
1 1/4	1.386 (35.20)	± 0.003 (± 0.08)	1.372 (34.85)	± 0.003 (± 0.08)
1 1/2	1.640 (41.66)	± 0.004 (± 0.10)	1.622 (41.20)	± 0.004 (± 0.10)
2	2.141 (54.38)	± 0.004 (± 0.10)	2.123 (53.92)	± 0.004 (± 0.10)

Socket Length, In. (mm) "C" min.	Inside Diameter In. (mm) "D" min.	Wall Thickness, In. (mm)		
		Socket Entrance "EA" min.	Socket Bottom "EB" min.	"F"
0.500 (12.70)	0.489 (12.42)	0.068 (1.73)	0.102 (2.59)	0.128 (3.25)
0.700 (17.78)	0.715 (18.16)	0.080 (2.03)	0.102 (2.59)	0.128 (3.25)
0.900 (22.86)	0.921 (23.39)	0.102 (2.59)	0.102 (2.59)	0.128 (3.25)
1.100 (27.94)	1.125 (28.58)	0.125 (3.18)	0.125 (3.18)	0.156 (3.96)
1.300 (33.02)	1.329 (33.76)	0.148 (3.76)	0.148 (3.76)	0.185 (4.70)
1.700 (43.18)	1.739 (44.17)	0.193 (4.90)	0.193 (4.90)	0.241 (6.12)

All information contained herein is given in good faith without guarantee of completeness or accuracy. If additional information is needed, please contact Charlotte Pipe and Foundry Company.

Minimum Dimensions From Center To End Of Socket (Laying Length) For CPVC 41, SDR 11 Fittings

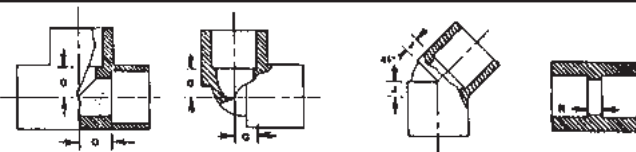

Nominal Size (in.)	"G" min. in. (mm)	"J" min. in. (mm)	"N" min. in. (mm)
1/2	0.382 (9.70)	0.183 (4.65)	0.102 (2.59)
3/4	0.507 (12.88)	0.235 (5.97)	0.102 (2.59)
1	0.633 (16.08)	0.287 (7.29)	0.102 (2.59)
1 1/4	0.758 (19.25)	0.339 (8.61)	0.102 (2.59)
1 1/2	0.884 (22.45)	0.391 (9.93)	0.102 (2.59)
2	1.134 (28.83)	0.495 (12.57)	0.102 (2.59)

Pressure Ratings For CPVC 4120, SDR 11 Plastic Pipe

Nominal Size (in.)	Pressure Rating, PSI	
	73.4° F (23° C)	180° F (82° C)
1/2	400	100
3/4	400	100
1	400	100
1 1/4	400	100
1 1/2	400	100
2	400	100

Pressure/Temperature Relationship

Maximum Operating Temperatures For Various Piping Systems (de-rate operating pressure at temperatures in excess of 73°F)

Piping System	Max. Operating Temp. °F
ABS	140
PVC	140
CPVC - FlowGuard Gold® CTS	180
CPVC - Corzan® Sch. 80	200
CPVC - ChemDrain®*	220

* See the ChemDrain Technical Manual for more information on this product.

NOTICE: The maximum recommended temperature and de-rating of working pressure applies to both heat generated from fluid being distributed through pipe system and heat generated from sources external to the pipe system.

Temperature De-Rating For Schedule 40 & 80 PVC & CPVC

The operating pressure of PVC and CPVC pipe will be reduced as the operating temperature increases above 73° F. To calculate this reduction, multiply the operating pressures shown on the previous pages by the correction factors shown below:

Operating Temperature (°F)	Correction Factors	
	PVC	CPVC
73	1.00	1.00
80	.88	1.00
90	.75	.91
100	.62	.82
110	.50	.77
120	.40	.65
130	.30	.62
140	.22	.50
150	NR	.47
160	NR	.40
170	NR	.32
180	NR	.25
200	NR	.20

For example, the operating pressure for 6" Schedule 80 CPVC pipe is 280 psi. If the operating temperature is 140° F, the maximum operating pressure is now 140 psi (280 x .50).

Temperature De-Rating for ASTM D 2846 CTS CPVC SDR 11 Piping Systems

Temperature °F	De-Rating Factor	Pressure Rating, PSI
73	1.00	400
80	1.00	400
90	0.91	360
100	0.82	325
120	0.65	260
140	0.50	200
160	0.40	160
180	0.25	100

Source: PPSA Bulletin No. 2-80 (10/79)

Example: Determine the maximum allowable operating pressure for a CTS CPVC piping system with an operating temperature of 140°F. The de-rating factor from the above chart is 0.50. Maximum allowable operating pressure = 400 x 0.50 = 200 psi.

De-rating Threaded Fittings, Valves and Unions

Pressure ratings shown are for socket (solvent cement) systems. The system must always be de-rated to the pressure rating of the lowest rated system component at the expected maximum system operating temperature.

- For pressure ratings of flanges or unions, see flanges and unions in the installation procedures section of this manual.
- Pressure ratings of Sch. 40 and Sch. 80 molded or cut threads are 50% of solvent cement systems. Please see table in the Threaded Joints and Threading of PVC and CPVC Pipe section of this manual.

- For pressure ratings of valves or other system components, always consult the technical recommendations from the manufacturers of those products.

NOTICE

Do not exceed the maximum working pressure of any system components including pipe, fittings, valves, molded or cut threads, unions, mechanical coupling or flanges.

- The pressure rating of all components must be reduced at temperatures above 73 degrees F. Refer to de-rating table in this manual.
- Exceeding the maximum working temperature or pressure of the system may result in system failure and property damage.

NOTICE

Use of FlowGuard Gold® CTS CPVC all-plastic threaded male adapters in hot water applications may result in system failure and property damage.

- Use plastic threaded CTS CPVC male adapters in cold water applications only.
- Use CTS CPVC x brass threaded transition fittings for hot water applications.
- Do not use compression fittings with brass ferrules to connect to CTS CPVC pipe or fittings where water temperatures will exceed 140 degrees F.
- CPVC pipe can be used with standard brass ferrules to make compression connections where the operating temperature will not exceed 140°F. Apply Teflon (PTFE) tape over the ferrule to allow for the dissimilar thermal expansion and contraction characteristics of the metal ferrule and the plastic pipe.

Low Temperature Recommendations

Like most materials, PVC and CPVC become more brittle at low temperatures, particularly at temperatures below freezing (32°F). Charlotte Pipe and Foundry recommends taking proper precautions when installing systems at low temperatures including providing proper insulation. If a system is designed to operate at temperatures below freezing (32°F), Charlotte Pipe recommends the following:

1. Reduce water hammer pressure surges to a minimum by:
 - a. Using only slow acting solenoid valves, if any;
 - b. Reducing pump start-up pressure surges with slow start-up motors and rubber expansion devices;
 - c. Not exceeding a maximum fluid velocity of 5-feet per second for PVC and CPVC Schedule 80 and 8-feet per second for CPVC CTS.
2. Provide more than minimum Charlotte Pipe recommended support spacing.
3. Thrust blocking at branches, changes in direction and end of runs.
4. Use expansion/contraction devices when temperature changes occur in runs.
5. Strictly follow chemical resistance recommendations.
6. Protect piping from UV.

Fluid Flow Properties

Gravity Flow

Manning Roughness Factor ("N" Value)

Fluid velocity, pipe size and hydraulic slope for gravity drainage can be determined using the Manning "N" value. This coefficient relates to the interior wall smoothness of pipe and is used for liquids with a steady flow, at a constant depth, in a prismatic open channel. The Manning's equation is shown below:

$$V = \frac{1.486 R^{2/3} S^{1/2}}{N}$$

Where:

V = Velocity of flow, ft./second

N = Manning's value

r = hydraulic radius, ft. obtained by dividing the cross sectional area of flow by the wetted perimeter of the pipe in contact with the flow. R is a special case for v with pipes either 1/2 full or full:

R = Inside diameter / 4, in feet

$$S = \frac{\text{Upstream elevation} - \text{Down stream elevation}}{\text{pipe length}} \text{ (ft./ft.)}$$

Example 1:

2" diameter schedule 40 PVC,

flowing full 30 foot pipe run, 7.5 inch drop

$$S = \frac{17.5'' - 10.0''}{30 \text{ ft.}} = 0.0208 \text{ ft./ft.}$$

$$R = \frac{2.067''}{4} = 0.043 \text{ ft.}$$

$$V = \frac{1.486 R^{2/3} S^{1/2}}{N}$$

Manning's "N" value is generally accepted as 0.009 for Designing gravity sewer systems

$$V = \frac{1.486 (0.043)^{2/3} (0.0208)^{1/2}}{0.009}$$

$$V = 2.9 \text{ ft./second}$$

Example 2:

4" diameter schedule 40 ABS, flowing 1/2 full

10 foot pipe run, 1.5 inch drop

$$S = \frac{20'' - 18.5''}{10 \text{ ft.}} = 0.0125 \text{ ft./ft.}$$

$$R = \frac{4.026''}{4} = 0.0839 \text{ ft.}$$

Assume "N" to be 0.010

$$V = \frac{1.486 (0.0839)^{2/3} (0.0125)^{1/2}}{0.010}$$

$$V = 3.2 \text{ ft./second}$$

It is widely recommended that the flow velocity in sanitary sewer systems to be equal to or greater than 2.0 feet per second for self cleaning drain lines.

Laboratory tests have shown that the "N" value for ABS and PVC pipe ranges from .008 to .012. The table below shows "N" values for other piping materials.

"N" Values For Typical Piping Materials

Piping Material	"N" Values
Cast Iron	.011 - .015
Finished Concrete	.011 - .015
Unfinished Concrete	.013 - .017
Corrugated Metal	.021 - .027
Glass	.009 - .013
Clay	.011 - .017

Fluid Flow Rate

Calculation of Volume Flow Rate:

$$Q = aV$$

Where:

a = Cross sectional area of flow, ft.²

V = Flow Velocity, ft/sec

Q = Volume flow rate, ft³/sec

Example 1:

2" Schedule 40 PVC

Where:

di = inside diameter of pipe in inches

$$a = \frac{\pi di^2}{4} = \frac{\pi (2.06712)^2}{4} = 0.0233 \text{ ft}^2$$

$$V = 2.9 \text{ ft/sec}$$

$$Q = 0.0233 \times 2.9 = 0.0676 \text{ ft}^3/\text{sec}$$

$$Q = \frac{0.0676 \text{ ft}^3}{\text{sec}} \times \frac{7.48 \text{ gal}}{\text{ft}^3} \times \frac{60 \text{ sec}}{\text{min}} = \frac{30.3 \text{ gals}}{\text{min}}$$

Example 2:

4" Schedule 40 PVC

$$a = \frac{1}{2} \left(\frac{\pi di^2}{4} \right) = \frac{\pi (4.02612)^2}{2 \times 4} = 0.0442 \text{ ft}^2$$

$$V = 3.2 \text{ ft/sec}$$

$$Q = 0.0442 \times 3.2 = 0.141 \text{ ft}^3/\text{sec}$$

$$Q = \frac{0.141 \text{ ft}^3}{\text{sec}} \times \frac{7.48 \text{ gal}}{\text{ft}^3} \times \frac{60 \text{ sec}}{\text{min}} = \frac{63.5 \text{ gals}}{\text{min}}$$

Pressure Flow

Friction loss through PVC pipe is normally obtained by using the Hazen-Williams equation shown below for water:

$$f = 0.2083 \times \left(\frac{100}{C}\right)^{1.852} \times \frac{Q^{1.852}}{di^{4.8655}}$$

Where:

- f = friction head loss in feet of water per 100 feet of pipe
- C = constant for inside pipe roughness (C = 150 for ABS and PVC pipe)
- Q = flow in U.S. gallons per minute
- di = inside diameter of pipe in inches

Water Velocities

Water velocities in feet per second may be calculated as follows:

$$V = 0.408709 \frac{Q}{di^2}$$

Where:

- V = velocity in feet per second
- Q = flow in U.S. gallons per minute
- di = inside diameter of pipe in inches

Friction Loss Through Fittings

The friction loss through fittings is considered to be equivalent to the loss through a certain number of linear feet of pipe of the same diameter as the fittings. To determine the loss through a piping system, add together the number of "equivalent feet" calculated for the fittings in the system.

The chart below shows approximate friction losses, in equivalent feet, for a variety of Schedule 40 & 80 PVC and CPVC fittings of different sizes.

Approximate Friction Loss For PVC and CPVC Fittings In Equivalent Feet Of Straight Pipe

Fitting	1/2"	3/4"	1"	1 1/4"	1 1/2"	2"	2 1/2"	3"	4"	6"	8"
Tee (Run)	1.0	1.4	1.7	2.3	2.7	4.3	5.1	6.2	8.3	12.5	16.5
Tee (Branch)	4.0	5.0	6.0	7.3	8.4	12.0	15.0	16.4	22.0	32.7	49.0
90° Elbow	1.5	2.0	2.5	3.8	4.0	5.7	6.9	7.9	12.0	18.0	22.0
45° Elbow	.80	1.1	1.4	1.8	2.1	2.6	3.1	4.0	5.1	8.0	10.6
Male/Female Adapter	1.0	1.5	2.0	2.75	3.5	4.5	5.5	6.5	9.0	14.0	—

The table on page 47 shows friction heads in feet and friction losses in psi for schedule 40 pipe. It also shows the gallons per minute (GPM) and velocities (in feet per second) for various pipe sizes.

Water Hammer

Water hammer is a term used to describe the sudden increase in pressure created by quickly stopping, starting, or changing the direction of the flow of fluid in a piping system. Typical actions which cause water hammer are:

- (1) Quick closing a valve.
- (2) Quick opening a valve.
- (3) Starting pumps with an empty discharge line.
- (4) A high speed wall of liquid (such as starting a pump) suddenly changes direction (such as going through a 90° elbow).
- (5) Moving entrapped air through the system.

The pressure increase generated must be added to the fluid pressure already existing in the piping system to determine the total pressure the system must withstand. **CAUTION!** If water hammer is not accounted for, the sudden pressure surge could be enough to burst the pipe, or break the fittings or valves.

Taking the following measures will help prevent problems:

- (1) Keep fluid velocities under 5 feet per second for PVC and 8 feet per second for CTS CPVC.
- (2) Use actuated valves with controlled opening and closing speeds.
- (3) Instruct operators of manual valves on the proper opening and closing speeds.
- (4) When starting a pump, partially close the valve in the discharge line to minimize the volume of liquid accelerating through the system. Fully open the valve after the line is completely filled.
- (5) Use a check valve in the pipe line, near the pump, to keep the line full.
- (6) Use air relief valves to control the amount of air that is admitted or exhausted throughout the piping system.
- (7) Design the piping system so that the total pressure (operating plus water hammer surge) does not exceed the pressure rating of the lowest rated component in the system.

How To Use The Nomograph On The Following Page:

1. Liquid Velocity (feet/second), pipeline length (feet), and valve closing time (seconds) must be known.
2. Place a straight edge on the liquid velocity in pipe (line A) and the pipeline length (line D).
3. Mark intersection of straight edge with pivot line (line C).
4. Place straight edge on mark just placed on pivot line (line C) and on valve closing time for valve being used (line A).
5. The intersection of the straight edge with the pressure increase line (line B) is the liquid momentum surge pressure (water hammer).

The liquid momentum surge pressure should be added to the operating line pressure to determine the system's maximum line pressure. The maximum line pressure is used to select the proper pipe schedule or wall thickness.

The nomograph is based on the formula

$$P = \frac{0.070VL}{T}$$

where P is increase in pressure due to momentum surge in psi, L is pipeline length in feet, V is liquid velocity in feet per second, and T is valve closing time in seconds.

Water Hammer Nomograph

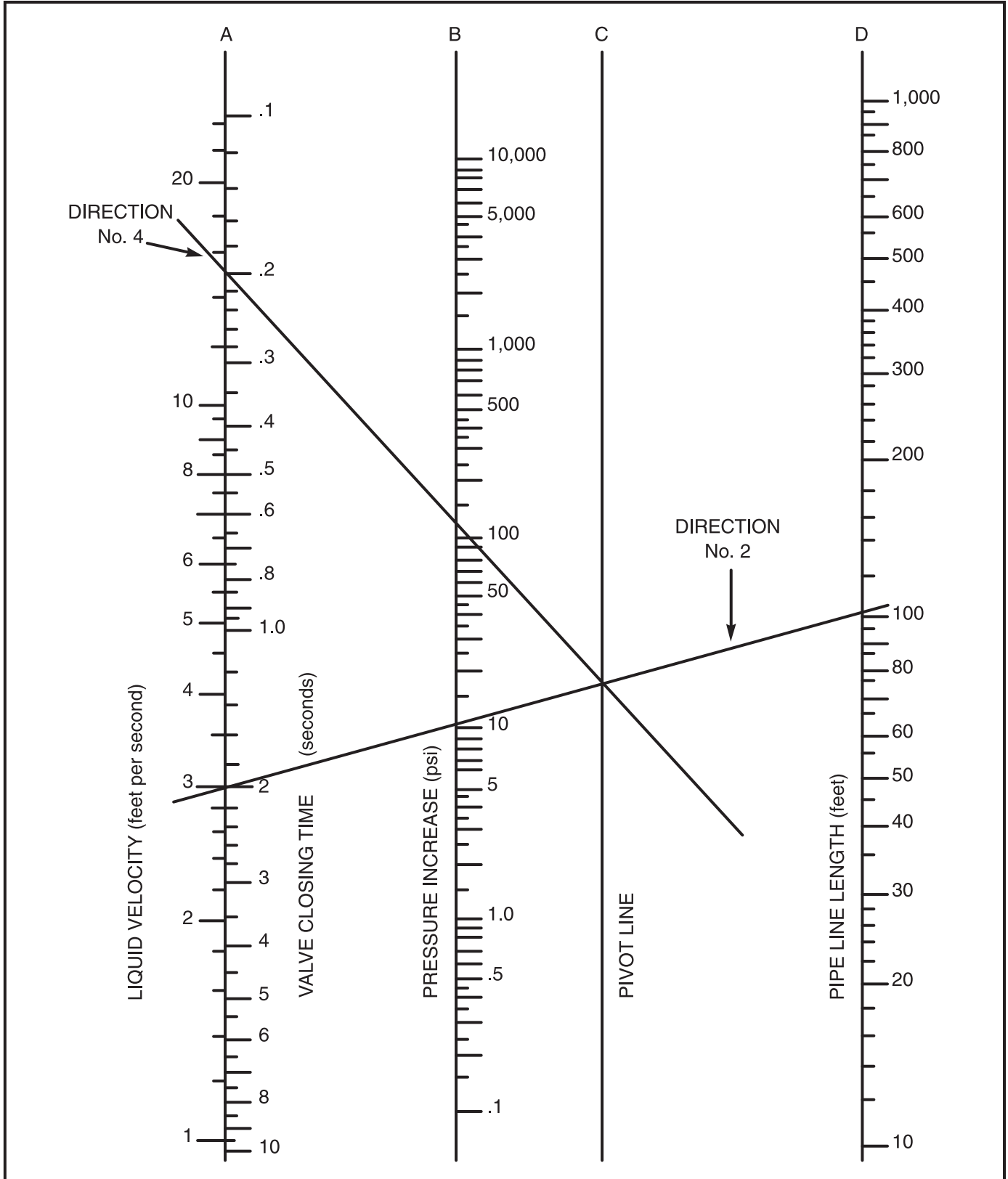

Entrapped Air

Source

There are many potential sources for air in pipelines. Air may be introduced at the point where fluid enters the system or during initial filling of the system.

Problem

Air in a piping system tends to accumulate at high points in the system. As the flowrate increases, the entrapped air is forced along the pipeline by the moving water. These pockets of air cause flow restrictions reducing the efficiency and performance of the system. Water is about 5 times more dense than air at 100 psi, so when a pocket of air reaches an outlet, it escapes rapidly and water rushes to replace the void. Such pressure surges can easily exceed the strength of a piping system and its components.



WARNING

Entrapped Air

- **Pressure surges associated with entrapped air may result in serious personal injury, system failure, and property damage.**
- Install air relief valves at the high points in a system to vent air that accumulates during service.
- Failure to bleed trapped air may give faulty test results and may result in an explosion.

Solution

Designers should be concerned about entrapped air, but the issue of entrapped air is very complex. The behavior of air in a piping system is not easy to analyze, but the effects can be devastating. Obviously, the best way to reduce problems would be to prevent air from entering the system. Systems should be filled slowly and air vented from the high points before the system is pressurized. Additionally, air relief valves should be installed at high points in the system to vent air that accumulates during service.

WEATHERING

UV Exposure

PVC, CPVC and ABS pipe can suffer surface discoloration when exposed to ultraviolet (UV) radiation from sunlight. UV radiation affects PVC, CPVC and ABS when energy from the sun causes excitation of the molecular bonds in the plastic. The resulting reaction occurs only on the exposed surface of the pipe and to the extremely shallow depths of .001 to .003 inches. The effect does not continue when exposure to sunlight is terminated.

A two-year study was undertaken to quantify the effects of UV radiation on the properties of PVC pipe (See Uni-Bell's UNI-TR-5). The study found that exposure to UV radiation results in a change in the pipe's surface color and a reduction in impact strength. Other properties such as tensile strength (pressure rating) and modulus of elasticity (pipe stiffness) are not adversely affected.

The presence of an opaque shield between the sun and the pipe prevents UV degradation. UV radiation will not penetrate thin shields such as paint coatings or wrappings. Burial of PVC, CPVC and ABS pipe provides complete protection against UV attack.

The most common method used to protect above ground PVC, CPVC and ABS pipe from the sun is painting with a latex (water base) paint. Preparation of the surface to be painted is very important. The pipe should be cleaned to remove moisture, dirt, and oil and wiped with a clean, dry cloth. **NOTICE:** Petroleum-based paints should not be used, since the presence of petroleum will prevent proper bonding of paint to pipe.

Reference: Uni-Bell PVC Pipe Association 2001.

Heat Build-Up

In addition to considering ambient air and operating temperatures in a piping system, piping designers must consider the radiant effect of sunlight when selecting piping material. Testing to the ASTM D 4803 Standard Test Method for Predicting Heat Build-up in PVC Building Products indicates that radiant heat from the sun can increase pipe surface temperatures by 50°F or more, possibly causing a piping system to exceed maximum working temperature or de-rated pressure carrying capability. Painting dark colored pipe with a light pigmented water based paint may reduce, but will not eliminate heat build-up.

FRICION LOSS AND FLOW VELOCITY FOR SCHEDULE 40 THERMOPLASTIC PIPE

(Friction head and friction loss are per 100 feet of pipe.) NOTICE: Flow velocity should not exceed 5 feet per second. Velocities in excess of 5 feet per second may result in system failure and property damage.

Gallons Per Minute	½ in.			¾ in.			1 in.			1¼ in.			2 in.			2½ in.			3 in.			14 in.			16 in.		
	Velocity Feet Per Second	Friction Head Feet	Friction Loss Pounds Per Square Inch	Velocity Feet Per Second	Friction Head Feet	Friction Loss Pounds Per Square Inch	Velocity Feet Per Second	Friction Head Feet	Friction Loss Pounds Per Square Inch	Velocity Feet Per Second	Friction Head Feet	Friction Loss Pounds Per Square Inch	Velocity Feet Per Second	Friction Head Feet	Friction Loss Pounds Per Square Inch	Velocity Feet Per Second	Friction Head Feet	Friction Loss Pounds Per Square Inch	Velocity Feet Per Second	Friction Head Feet	Friction Loss Pounds Per Square Inch	Velocity Feet Per Second	Friction Head Feet	Friction Loss Pounds Per Square Inch	Velocity Feet Per Second	Friction Head Feet	Friction Loss Pounds Per Square Inch
1	1.13	2.08	0.90	0.63	0.51	0.22	0.77	0.55	0.24	0.44	0.14	0.06	0.33	0.07	0.03	0.49	0.066	0.029	0.30	0.038	0.016	0.22	0.015	0.007			
2	2.26	4.16	1.80	1.26	1.02	0.44	1.93	1.72	0.75	1.11	0.44	0.19	0.81	0.22	0.09	0.69	0.11	0.048	0.49	0.051	0.023	0.31	0.021	0.009			
5	5.64	23.44	10.15	3.16	5.73	2.48	2.72	3.17	1.37	1.55	0.81	0.35	1.13	0.38	0.17	0.69	0.11	0.048	0.68	0.09	0.039	0.44	0.03	0.013			
7	7.90	43.06	18.64	4.43	10.52	4.56	3.86	6.02	2.61	2.21	1.55	0.67	1.62	0.72	0.31	0.98	0.21	0.091	1.03	0.19	0.082	0.66	0.07	0.030			
10	11.28	82.02	35.51	6.32	20.04	8.68	5.79	12.77	5.55	3.31	3.28	1.42	2.42	1.53	0.66	1.46	0.45	0.19	1.37	0.32	0.14	0.88	0.11	0.048			
15				9.48	42.46	18.39	7.72	21.75	9.42	4.42	5.59	2.42	3.23	2.61	1.13	2.44	1.15	0.50	1.71	0.49	0.21	1.10	0.17	0.074			
20	0.51	0.03	0.013	12.65	72.34	31.32	11.58	46.08	19.95	6.63	11.85	5.13	4.85	3.66	4.04	3.95	1.71	2.44	1.95	2.05	0.68	1.33	0.23	0.10			
25	0.64	0.04	0.017																								
30	0.77	0.06	0.026																								
35	0.89	0.08	0.035																								
40	1.02	0.11	0.048																								
45	1.15	0.13	0.056																								
50	1.28	0.16	0.069																								
60	1.53	0.22	0.095																								
70	1.79	0.30	0.13																								
75	1.92	0.34	0.15																								
80	2.05	0.38	0.16																								
90	2.30	0.47	0.20																								
100	2.56	0.58	0.25																								
125	3.20	0.88	0.38																								
150	3.84	1.22	0.53																								
175	4.48	1.63	0.71																								
200	5.11	2.08	0.90																								
250	6.40	3.15	1.36																								
300	7.67	4.41	1.91																								
350	8.95	5.87	2.55																								
400	10.23	7.52	3.26																								
450																											
500																											
750																											
1000																											
1250																											
1500																											
2000																											
2500																											
3000																											
3500																											
4000																											
4500																											
5000																											
5500																											
6000																											
6500																											
7000																											
7500																											
8000																											
8500																											
9000																											
9500																											
10000																											

FRICION LOSS AND FLOW VELOCITY FOR SCHEDULE 80 THERMOPLASTIC PIPE

(Friction head and friction loss are per 100 feet of pipe.)

NOTICE: Flow velocity should not exceed 5 feet per second. Velocities in excess of 5 feet per second may result in system failure and property damage.

Gallons Per Minute	½ in.			¾ in.			1 in.			1¼ in.			2 in.			2½ in.			3 in.		
	Velocity Feet Per Second	Friction Head Feet	Friction Loss Pounds Per Square Inch	Velocity Feet Per Second	Friction Head Feet	Friction Loss Pounds Per Square Inch	Velocity Feet Per Second	Friction Head Feet	Friction Loss Pounds Per Square Inch	Velocity Feet Per Second	Friction Head Feet	Friction Loss Pounds Per Square Inch	Velocity Feet Per Second	Friction Head Feet	Friction Loss Pounds Per Square Inch	Velocity Feet Per Second	Friction Head Feet	Friction Loss Pounds Per Square Inch	Velocity Feet Per Second	Friction Head Feet	Friction Loss Pounds Per Square Inch
1	1.48	4.02	1.74	0.74	0.86	0.37	0.94	0.88	0.38	0.52	0.21	0.09	0.38	0.10	0.041	0.39	0.05	0.022	0.25	0.02	0.009
2	2.95	8.03	3.48	1.57	1.72	0.74	2.34	2.75	1.19	1.30	0.66	0.29	0.94	0.30	0.126	0.54	0.07	0.032	0.50	0.028	0.012
5	7.39	45.23	19.59	3.92	9.67	4.19	6.28	5.04	2.19	1.82	1.21	0.53	1.32	0.55	0.24	0.78	0.12	0.052	1.50	0.04	0.017
7	10.34	83.07	35.97	5.49	17.76	7.69	4.68	9.61	4.16	2.60	2.30	1.00	1.88	1.04	0.45	1.12	0.29	0.11	2.00	0.05	0.022
10				7.84	33.84	14.65	7.01	20.36	8.82	3.90	4.87	2.11	2.81	2.20	0.95	1.68	0.62	0.11	2.75	0.09	0.039
15				11.76	71.70	31.05	9.35	34.68	15.02	5.20	8.30	3.59	3.75	3.75	1.62	2.23	1.06	0.19	4.00	0.15	0.065
20	0.57	0.06	0.017				11.69	52.43	22.70	6.50	12.55	5.43	4.69	5.67	2.46	1.95	1.60	0.29	5.25	0.22	0.095
25	0.72	0.08	0.026				14.03	73.48	31.82	7.80	17.59	7.62	5.63	7.95	3.44	3.35	2.25	0.54	6.41	0.31	0.13
30	0.86	0.08	0.035							9.10	23.40	10.13	6.57	10.58	4.58	3.91	2.99	1.29	7.74	0.42	0.18
35	1.00	0.11	0.048							10.40	29.97	12.98	7.50	13.55	5.87	4.47	3.83	1.60	9.04	0.54	0.23
40	1.15	0.14	0.061							11.70	37.27	16.14	8.44	16.85	7.30	5.03	4.76	2.07	1.99	0.67	0.29
45	1.29	0.17	0.074							13.00	45.30	19.61	9.38	20.48	8.87	5.58	5.79	2.51	2.49	0.81	0.35
50	1.43	0.21	0.091										11.26	28.70	12.43	6.70	8.12	3.52	3.90	1.14	0.49
60	1.72	0.30	0.13				0.63	0.03	0.013							7.82	10.80	4.68	5.46	1.51	0.65
70	2.01	0.39	0.17				0.75	0.04	0.017							8.38	12.27	5.31	5.85	1.72	0.74
75	2.15	0.45	0.19				0.88	0.05	0.022							8.93	13.83	5.99	6.24	1.94	0.84
80	2.29	0.50	0.22				1.00	0.07	0.030							10.05	17.20	7.45	7.02	2.31	1.04
90	2.58	0.63	0.27				1.13	0.08	0.035							11.17	20.90	9.05	7.80	2.93	1.27
100	2.87	0.76	0.33				1.25	0.10	0.043										9.75	3.72	1.92
125	3.59	1.16	0.50				1.57	0.16	0.068										11.70	18.48	8.00
150	4.30	1.61	0.70				1.88	0.22	0.095												
175	5.02	2.15	0.93				2.20	0.29	0.12												
200	5.73	2.75	1.19				2.51	0.37	0.16												
250	7.16	4.16	1.81				3.14	0.56	0.24												
300	8.60	5.83	2.52				3.76	0.78	0.34												
350	10.03	7.76	3.36				4.39	1.04	0.45												
400	11.47	9.93	4.30				5.02	1.33	0.58												
450							5.64	1.65	0.71												
500							6.27	2.00	0.87												
750							9.40	4.25	1.84												
1000							12.54	7.23	3.13												
1250																					
1500																					
2000																					
2500																					
3000																					
3500																					
4000																					
4500																					
5000																					
5500																					
6000																					
6500																					
7000																					
7500																					
8000																					
8500																					
9000																					
9500																					
10000																					

FRICTION LOSS AND FLOW VELOCITY FOR SDR 21 THERMOPLASTIC PIPE

(Friction head and friction loss are per 100 feet of pipe.)

NOTICE: Flow velocity should not exceed 5 feet per second. Velocities in excess of 5 feet per second may result in system failure and property damage.

Gallons Per Minute	½ in.			¾ in.			1 in.			1¼ in.			1½ in.			2 in.			2½ in.			3 in.		
	Velocity Feet Per Second	Friction Head Feet	Friction Loss Pounds Per Square Inch	Velocity Feet Per Second	Friction Head Feet	Friction Loss Pounds Per Square Inch	Velocity Feet Per Second	Friction Head Feet	Friction Loss Pounds Per Square Inch	Velocity Feet Per Second	Friction Head Feet	Friction Loss Pounds Per Square Inch	Velocity Feet Per Second	Friction Head Feet	Friction Loss Pounds Per Square Inch	Velocity Feet Per Second	Friction Head Feet	Friction Loss Pounds Per Square Inch	Velocity Feet Per Second	Friction Head Feet	Friction Loss Pounds Per Square Inch	Velocity Feet Per Second	Friction Head Feet	Friction Loss Pounds Per Square Inch
1	0.84	1.00	0.44	0.50	0.28	0.12	0.60	0.30	0.13	0.095	0.04	0.29	0.05	0.022	0.18	0.023	0.010	0.31	0.031	0.014	0.20	0.015	0.006	
2	1.67	2.00	0.87	0.99	0.56	0.24	1.50	0.93	0.41	0.30	0.13	0.71	0.15	0.065	0.45	0.06	0.025	0.43	0.044	0.020	0.29	0.021	0.009	
5	4.17	11.25	4.87	2.47	3.14	1.36	2.09	1.70	0.74	0.54	0.23	0.99	0.28	0.12	0.63	0.081	0.035	0.61	0.07	0.03	0.41	0.03	0.013	
7	5.84	20.66	8.95	3.46	5.76	2.49	2.99	3.24	1.40	1.86	0.44	1.41	0.52	0.23	0.90	0.17	0.074	0.62	0.06	0.061	0.62	0.06	0.026	
10	8.34	39.34	17.03	4.94	10.96	4.75	4.49	6.86	2.97	2.79	0.94	2.12	1.11	0.48	1.35	0.37	0.16	0.92	0.14	0.11	0.83	0.09	0.039	
15				7.40	23.23	10.06	5.98	11.68	5.06	3.68	1.59	2.83	1.89	0.82	1.80	0.63	0.27	1.23	0.25	0.11	1.23	0.14	0.061	
20	0.50	0.03	0.013	9.87	39.57	17.13	7.48	17.66	7.65	4.65	2.41	3.54	2.85	1.23	2.25	0.95	0.41	1.53	0.37	0.16	1.03	0.14	0.061	
25	0.62	0.04	0.017				8.97	24.76	10.72	7.80	3.38	4.24	4.00	1.73	2.71	1.34	0.58	1.84	0.52	0.23	1.24	0.20	0.087	
30	0.75	0.06	0.026	0.49	0.02	0.009	10.47	32.94	14.26	10.37	4.49	5.66	6.81	2.95	3.61	2.27	0.98	2.15	0.70	0.30	1.45	0.27	0.12	
35	0.87	0.08	0.035	0.57	0.03	0.013				13.28	5.75	6.37	8.47	3.67	4.06	2.83	1.23	2.76	1.11	0.48	1.86	0.42	0.18	
40	1.00	0.10	0.043	0.65	0.04	0.017	10.47	32.94	14.26	16.52	7.15	7.06	10.29	4.46	4.51	3.44	1.49	3.07	1.35	0.58	2.06	0.51	0.22	
45	1.12	0.12	0.052	0.74	0.04	0.017				18.14	12.18	8.49	14.42	6.24	5.41	4.82	2.09	3.68	1.89	0.82	2.48	0.72	0.31	
50	1.25	0.15	0.065	0.82	0.05	0.022	0.58	0.02	0.009	20.08	8.69	9.90	19.19	8.31	6.76	7.29	3.16	4.29	2.51	1.09	2.89	0.96	0.42	
60	1.50	0.21	0.091	0.98	0.08	0.035	0.69	0.03	0.013	28.14	12.18	8.49	14.42	9.44	7.21	8.21	3.55	4.91	3.22	1.39	3.30	1.23	0.53	
70	1.75	0.28	0.12	1.14	0.10	0.043	0.81	0.04	0.022			10.61	21.80		8.12	10.21	4.42	5.52	4.00	1.73	3.72	1.52	0.66	
75	1.87	0.32	0.14	1.23	0.11	0.048	0.86	0.05	0.022						9.02	12.41	5.37	6.14	4.86	2.10	4.13	1.85	0.80	
80	2.00	0.36	0.16	1.31	0.13	0.056	0.92	0.05	0.022									6.14	4.86	2.10	4.13	1.85	0.80	
90	2.25	0.45	0.19	1.47	0.16	0.069	1.04	0.07	0.030									6.14	4.86	2.10	4.13	1.85	0.80	
100	2.50	0.54	0.23	1.63	0.19	0.082	1.15	0.08	0.035									6.14	4.86	2.10	4.13	1.85	0.80	
125	3.13	0.82	0.36	2.04	0.30	0.13	1.44	0.125	0.054									6.14	4.86	2.10	4.13	1.85	0.80	
150	3.75	1.15	0.50	2.45	0.41	0.18	1.73	0.18	0.078									6.14	4.86	2.10	4.13	1.85	0.80	
175	4.37	1.54	0.67	2.86	0.55	0.24	2.02	0.24	0.103									6.14	4.86	2.10	4.13	1.85	0.80	
200	4.99	1.96	0.85	3.27	0.70	0.30	2.31	0.30	0.13									6.14	4.86	2.10	4.13	1.85	0.80	
250	6.24	2.97	1.29	4.09	1.06	0.46	2.89	0.46	0.20									6.14	4.86	2.10	4.13	1.85	0.80	
300	7.49	4.16	1.80	4.90	1.48	0.64	3.46	0.63	0.27									6.14	4.86	2.10	4.13	1.85	0.80	
350	8.74	5.54	2.40	5.72	1.98	0.86	4.04	0.85	0.37									6.14	4.86	2.10	4.13	1.85	0.80	
400	9.99	7.09	3.07	6.54	2.53	1.10	4.61	1.08	0.47									6.14	4.86	2.10	4.13	1.85	0.80	
450	11.24	8.82	3.82	7.35	3.14	1.36	5.19	1.34	0.58									6.14	4.86	2.10	4.13	1.85	0.80	
500	12.48	10.72	4.64	8.17	3.82	1.65	5.76	1.63	0.71									6.14	4.86	2.10	4.13	1.85	0.80	
750				12.26	8.09	3.50	8.64	3.46	1.50									6.14	4.86	2.10	4.13	1.85	0.80	
1000							11.53	5.89	2.55									6.14	4.86	2.10	4.13	1.85	0.80	
1250																		6.14	4.86	2.10	4.13	1.85	0.80	
1500																		6.14	4.86	2.10	4.13	1.85	0.80	
2000																		6.14	4.86	2.10	4.13	1.85	0.80	
2500																		6.14	4.86	2.10	4.13	1.85	0.80	
3000																		6.14	4.86	2.10	4.13	1.85	0.80	
3500																		6.14	4.86	2.10	4.13	1.85	0.80	
4000																		6.14	4.86	2.10	4.13	1.85	0.80	
4500																		6.14	4.86	2.10	4.13	1.85	0.80	

FRICITION LOSS AND FLOW VELOCITY FOR SDR 26 THERMOPLASTIC PIPE

(Friction head and friction loss are per 100 feet of pipe.)

NOTICE: Flow velocity should not exceed 5 feet per second. Velocities in excess of 5 feet per second may result in system failure and property damage.

Gallons Per Minute	¾ in.			1 in.			1¼ in.			1½ in.			2 in.			2½ in.			3 in.		
	Velocity Feet Per Second	Friction Head Feet	Friction Loss Pounds Per Square Inch	Velocity Feet Per Second	Friction Head Feet	Friction Loss Pounds Per Square Inch	Velocity Feet Per Second	Friction Head Feet	Friction Loss Pounds Per Square Inch	Velocity Feet Per Second	Friction Head Feet	Friction Loss Pounds Per Square Inch	Velocity Feet Per Second	Friction Head Feet	Friction Loss Pounds Per Square Inch	Velocity Feet Per Second	Friction Head Feet	Friction Loss Pounds Per Square Inch	Velocity Feet Per Second	Friction Head Feet	Friction Loss Pounds Per Square Inch
1	0.84	1.00	0.43	0.50	0.28	0.12	0.59	0.29	0.13	0.36	0.27	0.02	0.087	0.01	0.004	0.30	0.025	0.011	0.20	0.01	0.0045
2	1.67	2.00	0.86	0.99	0.56	0.24	1.48	0.91	0.39	0.90	0.14	0.059	0.044	0.0045	0.020	0.42	0.035	0.015	0.28	0.014	0.0063
5	4.17	11.25	4.87	2.47	3.14	1.36	2.08	1.66	0.72	1.25	0.49	0.21	0.104	0.08	0.035	0.59	0.06	0.026	0.40	0.02	0.009
7	5.84	20.66	8.95	3.46	5.76	2.49	2.79	2.16	1.37	1.79	0.92	0.40	0.20	0.16	0.069	0.88	0.13	0.056	0.59	0.05	0.022
10	8.34	39.34	17.03	4.94	10.96	4.74	2.96	3.16	1.37	2.68	1.36	0.47	0.20	0.20	0.14	1.18	0.22	0.095	0.79	0.09	0.039
15				7.40	23.23	10.06	4.44	6.69	2.90	3.58	2.04	0.74	0.74	0.33	0.14	1.88	0.34	0.15	0.99	0.13	0.056
20	0.48	0.02	0.009	9.87	39.57	17.13	5.92	11.40	4.94	4.47	2.72	1.00	1.00	0.25	0.25	2.17	0.47	0.20	1.19	0.18	0.078
25	0.60	0.04	0.017	7.40	17.23	7.46	7.40	17.23	7.46	4.7	3.40	2.59	1.12	0.86	0.37	1.47	0.63	0.27	1.39	0.24	0.10
30	0.72	0.05	0.022	8.88	24.15	10.46	8.88	24.15	10.46	5.36	4.08	3.63	1.57	1.21	0.52	1.77	0.81	0.31	1.59	0.31	0.13
35	0.84	0.07	0.030	0.55	0.03	0.013	10.36	32.13	13.91	6.26	4.76	4.83	2.09	1.61	0.70	2.06	0.63	0.27	1.77	0.47	0.18
40	0.96	0.09	0.039	0.63	0.03	0.013	7.15	12.05	5.22	5.44	6.18	2.68	2.68	2.06	0.89	2.35	0.81	0.35	1.99	0.31	0.13
45	1.08	0.11	0.048	0.71	0.04	0.017	8.04	14.98	6.49	6.12	7.69	3.33	3.33	2.56	1.11	2.65	1.00	0.43	1.78	0.38	0.16
50	1.20	0.14	0.061	0.78	0.05	0.022	8.94	18.21	7.88	6.80	9.34	4.04	4.04	3.11	1.35	2.94	1.22	0.53	1.98	0.47	0.20
60	1.44	0.19	0.082	0.94	0.07	0.030	8.16	13.10	5.67	8.16	13.10	5.67	5.67	3.11	1.35	3.53	1.71	0.74	2.38	0.65	0.28
70	1.67	0.25	0.11	1.10	0.09	0.039	9.52	17.42	7.54	9.52	17.42	7.54	7.54	3.11	1.35	4.12	2.27	0.98	2.78	0.87	0.38
75	1.79	0.29	0.13	1.18	0.10	0.043	10.19	19.80	8.57	10.19	19.80	8.57	8.57	3.11	1.35	4.41	2.58	1.12	2.97	0.99	0.43
80	1.91	0.32	0.14	1.25	0.12	0.052	10.87	22.31	9.66	10.87	22.31	9.66	9.66	3.11	1.35	4.71	2.91	1.26	3.17	1.11	0.48
90	2.15	0.40	0.17	1.41	0.14	0.061	12.23	27.75	12.02	12.23	27.75	12.02	12.02	3.11	1.35	5.30	3.62	1.57	3.57	1.38	0.60
100	2.39	0.49	0.21	1.57	0.18	0.078	13.59	33.73	14.61	13.59	33.73	14.61	14.61	3.11	1.35	5.89	4.39	1.90	3.97	1.68	0.73
125	2.99	0.74	0.33	1.96	0.27	0.12	0.66	0.03	0.012	0.83	0.027	0.012	0.012	0.04	0.017	8.66	11.24	2.88	4.96	2.54	1.10
150	3.59	1.04	0.45	2.35	0.37	0.16	0.83	0.04	0.017	1.05	0.04	0.017	0.017	0.04	0.017	10.31	12.40	3.57	5.95	3.56	1.54
175	4.19	1.39	0.60	2.74	0.50	0.22	0.98	0.06	0.026	1.26	0.05	0.022	0.022	0.04	0.017	11.92	14.24	4.03	6.94	4.74	2.05
200	4.79	1.77	0.77	3.13	0.63	0.27	1.14	0.06	0.026	1.47	0.075	0.033	0.033	0.04	0.017	13.41	16.15	4.57	7.93	6.07	2.63
250	5.98	2.68	1.16	3.92	0.96	0.42	1.30	0.07	0.030	1.68	0.09	0.039	0.039	0.04	0.017	15.31	18.40	5.37	9.92	9.18	3.98
300	7.18	3.75	1.62	4.70	1.34	0.58	1.95	0.16	0.069	2.28	0.21	0.091	0.091	0.04	0.017	17.86	21.40	6.37	12.40	12.40	5.37
350	8.38	5.00	2.17	5.49	1.79	0.77	2.28	0.27	0.12	2.61	0.27	0.12	0.12	0.04	0.017	20.48	24.40	7.46	15.31	15.31	6.37
400	9.57	6.39	2.77	6.27	2.28	0.99	2.93	0.33	0.14	2.93	0.33	0.14	0.14	0.04	0.017	23.15	27.40	8.66	18.40	18.40	7.46
450	10.77	7.95	3.44	7.05	2.84	1.23	3.14	0.41	0.18	3.14	0.41	0.18	0.18	0.04	0.017	25.92	30.40	9.92	21.40	21.40	8.66
500	11.96	9.66	4.18	7.84	3.45	1.49	3.45	0.49	0.21	3.45	0.49	0.21	0.21	0.04	0.017	28.86	33.40	11.24	24.40	24.40	9.92
750				11.75	7.31	3.17	8.28	3.12	1.35	6.51	1.47	0.64	0.64	0.04	0.017	36.66	41.40	14.61	31.40	31.40	12.40
1000							11.05	5.31	2.30	8.15	2.23	0.96	0.96	0.04	0.017	45.31	50.40	18.40	38.40	38.40	15.31
1250										9.77	3.11	1.35	1.35	0.04	0.017	54.03	60.40	23.15	46.40	46.40	18.40
1500										13.03	5.30	2.29	2.29	0.04	0.017	63.86	71.40	28.86	55.40	55.40	21.40
2000										10.48	2.74	1.19	1.19	0.04	0.017	74.86	83.40	36.66	65.40	65.40	24.40
2500										12.58	3.84	1.66	1.66	0.04	0.017	87.03	96.40	46.40	76.40	76.40	28.86
3000										15.31	5.30	2.29	2.29	0.04	0.017	100.43	110.40	58.66	88.40	88.40	33.40
3500										18.40	7.46	3.12	3.12	0.04	0.017	114.24	125.40	73.15	102.40	102.40	38.40
4000										21.40	9.92	4.03	4.03	0.04	0.017	129.40	141.40	89.92	117.40	117.40	43.40
4500										24.40	12.40	5.37	5.37	0.04	0.017	145.40	158.40	108.40	133.40	133.40	48.40

FRICITION LOSS AND FLOW VELOCITY FOR SDR 11 CTS CPVC THERMOPLASTIC PIPE

(Friction head and friction loss are per 100 feet of pipe.)

NOTICE: Flow velocity should not exceed 8 feet per second. Velocities in excess of 8 feet per second may result in system failure and property damage.

Gallons Per Minute	½ in.			¾ in.			1 in.			1¼ in.			1½ in.			2 in.		
	Velocity Feet Per Second	Head Loss Feet of Water Per 100 Ft.	Pressure Loss PSI Per 100 Ft.	Velocity Feet Per Second	Head Loss Feet of Water Per 100 Ft.	Pressure Loss PSI Per 100 Ft.	Velocity Feet Per Second	Head Loss Feet of Water Per 100 Ft.	Pressure Loss PSI Per 100 Ft.	Velocity Feet Per Second	Head Loss Feet of Water Per 100 Ft.	Pressure Loss PSI Per 100 Ft.	Velocity Feet Per Second	Head Loss Feet of Water Per 100 Ft.	Pressure Loss PSI Per 100 Ft.	Velocity Feet Per Second	Head Loss Feet of Water Per 100 Ft.	Pressure Loss PSI Per 100 Ft.
1	1.71	3.19	1.38	0.80	0.50	0.22	0.48	0.15	0.06	1.61	1.09	0.47	1.16	0.49	0.21	0.68	0.13	0.06
2	3.42	11.53	5.00	1.60	1.82	0.79	0.96	0.53	0.23	3.23	3.94	1.71	2.31	1.75	0.76	1.35	0.49	0.21
3	5.13	24.43	10.59	2.40	3.85	1.67	1.44	1.12	0.49	4.84	8.35	3.62	3.47	3.71	1.61	2.03	1.03	0.45
4	6.83	41.62	18.04	3.20	6.55	2.84	1.93	1.91	0.83	6.46	14.23	6.17	4.63	6.33	2.74	2.70	1.76	0.76
5	8.54	62.91	27.27	4.00	9.91	4.29	2.41	2.89	1.25	8.07	21.51	9.33	5.78	9.56	4.15	3.38	2.66	1.15
6	10.25	88.18	38.23	4.79	13.89	6.02	2.89	4.05	1.76	9.68	30.15	13.07	6.94	13.40	5.81	4.05	3.73	1.62
7	11.96	117.32	50.86	5.59	18.47	8.01	3.37	5.39	2.34	11.30	40.11	17.39	8.09	17.83	7.73	4.73	4.96	2.15
8	13.67	150.23	65.13	6.39	23.66	10.26	3.85	6.90	2.99	12.91	51.37	22.27	9.25	22.83	9.90	5.40	6.35	2.75
9	15.38	186.85	81.00	7.19	29.42	12.76	4.33	8.58	3.72	14.52	63.89	27.70	10.41	28.40	12.31	6.08	7.89	3.42
10	17.08	227.11	98.45	7.99	35.76	15.50	4.82	10.43	4.52	16.14	77.66	33.66	11.56	34.52	14.96	6.75	9.60	4.16
15				11.99	75.78	32.85	7.22	22.11	9.58	17.75	92.65	40.16	12.72	41.18	17.85	7.43	11.45	4.96
20				15.98	129.11	55.97	9.63	37.67	16.33	18.88	106.19	46.03	13.88	48.38	20.97	8.10	13.45	5.83
25							12.04	56.94	24.69				16.19			9.46	17.89	7.76
30							14.45	79.82	34.60							10.61	22.91	9.93
35							16.86	106.19	46.03							12.16	28.50	12.35
40																13.51	34.64	15.02
45																16.89	52.37	22.70
50																		
55																		
60																		
70																		
80																		
90																		
100																		
125																		

Support Spacing For ABS, PVC and CPVC Pipe

Adequate support for any piping system is a matter of great importance. In practice, support spacings are a function of pipe size, operating temperatures, the location of heavy valves or fittings, and the mechanical properties of the pipe material.

To ensure the satisfactory operation of a DWV or pressure piping system, the location and type of hangers should be carefully considered. The principles of design for metallic piping systems are generally also applicable to DWV or pressure piping systems, but with some notable areas where special consideration should be exercised. Hangers should not compress, distort, cut or abrade the piping.

All piping should be supported with an approved hanger at intervals sufficiently close to maintain correct pipe alignment and to prevent sagging or grade reversal. Pipe should also be supported at all branch ends and at all changes of direction. Support trap arms as close as possible to the trap. In keeping with good plumbing practices, support and brace all closet bends and fasten closet flanges.

- (1) Concentrated loads (ie: Valves and other appurtenances) should be supported directly so as to eliminate high stress concentrations. Should this be impractical, then the pipe must be supported immediately adjacent to the load.
- (2) In systems where large fluctuations in temperature occur, allowances must be made for expansion and contraction of the piping system. Since changes in direction in the system are usually sufficient to allow for expansion and contraction, hangers must be placed so as not to restrict this movement.
- (3) Since plastic pipe expands or contracts approximately five times more than steel, hangers should not restrict this movement. When using a clamp-type hanger, the hanger should not force the pipe and fittings into position.
- (4) Hangers should provide as much bearing surface as possible. To prevent damage to the pipe, file smooth any sharp edges or burrs on the hangers or supports.
- (5) Plastic piping systems must not be placed alongside steam or other high temperature pipe lines or other high temperature objects.
- (6) Support spacing for horizontal piping systems must be determined by the maximum operating temperature the system will encounter. The piping should be supported on uniform centers with supports that do not restrict the axial movement.
- (7) For vertical lines, it is recommended that an engineer design the vertical supports according to the vertical load involved.
- (8) Changes in direction should be supported as close as practical to the fitting to avoid introducing excessive torsional stresses into the system. Please see the associated chart showing the recommended support spacing according to size, schedule, and operating temperatures. These spacings apply to continuous spans of uninsulated lines, with no concentrated loads, conveying liquids with specific gravities of up to 1.00.

NOTICE: The above information provides general guidelines. It should be used only as a reference and not as a guarantee of performance. Specific installation instructions and techniques may be required as a result of local plumbing and building codes, engineering specifications and instructions.

NOTICE

Failure to compensate for expansion and contraction caused by temperature change may result in system failure and property damage.

- Do not restrict expansion or contraction. Restraining movement in piping systems is not recommended and may result in joint or fitting failure.
- Use straps or clamps that allow for piping system movement.
- Align all piping system components properly without strain. Do not bend or pull pipe into position after being solvent welded.
- Do not terminate a pipe run against a stationary object (example: wall or floor joist).
- Do not install fittings under stress.

General Guidelines for Horizontal Support Spacing (in feet)

Nom. Pipe Size (in.)	PVC PIPE															ABS PIPE				
	SDR 21 PR200 & SDR 26 PR160					Schedule 40					Schedule 80					Schedule 40				
	Operating Temp. °F					Operating Temp. °F					Operating Temp. °F					Operating Temp. °F				
	60	80	100	120	140	60	80	100	120	140	60	80	100	120	140	60	80	100	120	140
½	3½	3½	3	2		4½	4½	4	2½	2½	5	4½	4½	3	2½					
¾	4	3½	3	2		5	4½	4	2½	2½	5½	5	4½	3	2½					
1	4	4	3½	2		5½	5	4½	3	2½	6	5½	5	3½	3					
1¼	4	4	3½	2½		5½	5½	5	3	3	6	6	5½	3½	3					
1½	4½	4	4	2½		6	5½	5	3½	3	6½	6	5½	3½	3½	6	6	5½	3½	3
2	4½	4	4	3		6	5½	5	3½	3	7	6½	6	4	3½	6	6	5½	3½	3
2½	5	5	4½	3		7	6½	6	4	3½	7½	7½	6½	4½	4					
3	5½	5½	4½	3		7	7	6	4	3½	8	7½	7	4½	4	7	7	7	4	3½
4	6	5½	5	3½		7½	7	6½	4½	4	9	8½	7½	5	4½	7½	7½	7	4½	4
6	6½	6½	5½	4		8½	8	7½	5	4½	10	9½	9	6	5	8½	8½	8	5	4½
8	7	6½	6	5		9	8½	8	5	4½	11	10½	9½	6½	5½					
10						10	9	8½	5½	5	12	11	10	7	6					
12						11½	10½	9½	6½	5½	13	12	10½	7½	6½					
14						12	11	10	7	6	13½	13	11	8	7					
16						12½	11½	10½	7½	6½	14	13½	11½	8½	7½					

NOTE: Always follow local code requirements for hanger spacing. Most plumbing codes have the following hanger spacing requirements:

- ABS and PVC pipe have a maximum horizontal hanger spacing of every four feet for all sizes.
- CPVC pipe or tubing has a maximum horizontal hanger spacing of every three feet for one inch and under and every four feet for sizes 1¼ inch and larger.

General Guidelines for Horizontal Support Spacing (in feet)

Nom. Pipe Size (in.)	CPVC PIPE									
	Schedule 80*					SDR 11				
	Operating Temp. °F					Operating Temp. °F				
60	80	100	120	140	180	73	100	140	180	
½	5½	5½	5	4½	4½	2½	4	4	3½	3
¾	5½	5½	5½	5	4½	2½	5	4½	4	3
1	6	6	6	5½	5	3	5½	5	4½	3
1¼	6½	6½	6	6	5½	3	6	5½	5	4
1½	7	7	6½	6	5½	3½	6½	6	5½	4
2	7	7	7	6½	6	3½	7½	7	6½	4
2½	8	7½	7½	7½	6½	4				
3	8	8	8	7½	7	4				
4	9	9	9	8½	7½	4½				
6	10	10½	9½	9	8	5				
8	11	11	10½	10	9	5½				
10	11½	11½	11	10½	9½	6				
12	12½	12½	12½	11	10½	6½				

*Note: This product is not currently available. Information provided is for reference only.

Typical Pipe Hangers, Clamps, and Supports

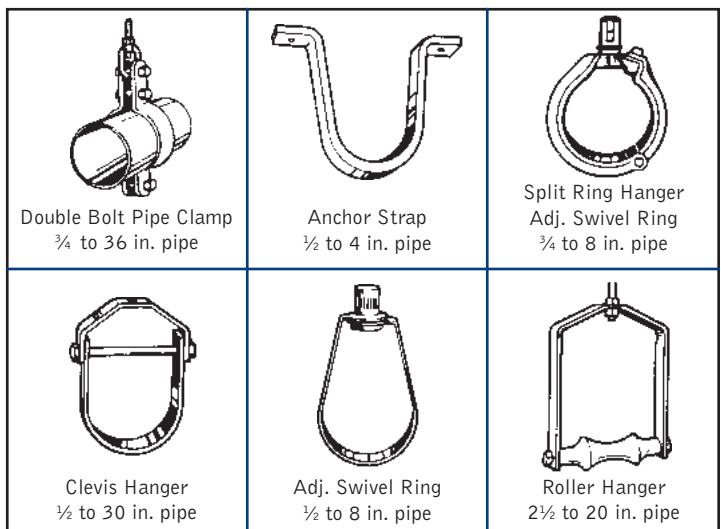

The pipe should not be anchored tightly by the support, but secured in a manner to allow for movement caused by thermal expansion and contraction. It is recommended that you use clamps or straps that allow pipe to remain away from the framing, thus reducing the noise generated when pipe is allowed to rub against wood.

Expansion and Contraction of PVC Schedule 40, PVC Schedule 80, PVC PR 200 and PVC PR 160

ABS, PVC and CPVC pipe, like other piping materials, undergo length changes as a result of temperature variations above and below the installation temperature. They expand and contract 4.5 to 5 times more than steel or iron pipe. The extent of the expansion or contraction is dependent upon the piping material's coefficient of linear expansion, the length of pipe between directional changes, and the temperature differential.

The coefficients of linear expansion (Y) for ABS, PVC, and CPVC (expressed in inches of expansion per 10°F temperature change per 100 feet of pipe) are as follows:

Material	Y (in./10°F/100 ft)
ABS	0.66
PVC	0.36
CPVC	0.408

The amount of expansion or contraction can be calculated using the following formula:

$$e = \frac{Y (T1-T2) \times Lp}{10 \times 100}$$

e = Dimensional change due to thermal expansion or contraction (in.)

Y = Expansion coefficient (See table above.) (in./10°F/100 ft)

(T1-T2) = Temperature differential between the installation temperature and the maximum or minimum system temperature, whichever provides the greatest differential (°F).

Lp = Length of pipe run between changes in direction (ft)

Example: How much expansion (e) can be expected in a 60 foot straight run of 2" diameter PVC pipe installed at 70°F and operating at 120°F?

Solution:

$$e = .360 \frac{(120 - 70)}{10} \times \frac{60}{100} = .360 \times 5 \times .6 = 1.08 \text{ inches}$$

There are several ways to compensate for expansion and contraction. The most common methods are:

1. Expansion Loops (Fig. 1)
2. Offsets (Fig. 2)
3. Change in direction (Fig. 3)

Expansion Joints

A wide variety of products are available to compensate for thermal expansion in piping systems including:

- Piston type expansion joints (Fig. 4)
- Bellows type expansion joints
- Flexible bends

The manufacturers of these devices should be contacted to determine the suitability of their products for the specific application. In many cases these manufacturers provide excellent technical information on compensation for thermal expansion. Information on these manufacturers and industry standard may be obtained through the Expansion Joint Manufacturers Association WWW.EJMA.ORG.

When installing an expansion loop, no rigid or restraining supports should be placed within the leg lengths of the loop. The loop should be installed as closely as possible to the mid-point between anchors. Piping support guides should restrict lateral movement and direct axial movement into the loop. Lastly, the pipe and fittings should be solvent cemented together, rather than using threaded connections.

Modulus of Elasticity & Working Stress

Table 1

	ABS		PVC		CPVC	
	Modulus of Elasticity (psi)	Working Stress (psi)	Modulus of Elasticity (psi)	Working Stress (psi)	Modulus of Elasticity (psi)	Working Stress (psi)
73° F	250,000	N/A	420,000	2,000	370,000	2,000
90° F	240,000	N/A	380,000	1,500	360,000	1,820
100° F	230,000	N/A	350,000	1,240	350,000	1,640
120° F	215,000	N/A	300,000	800	340,000	1,300
140° F	195,000	N/A	200,000	400	325,000	1,000
160° F	180,000	N/A	N/A	N/A	310,000	800
180° F	N/A	N/A	N/A	N/A	290,000	500

Modulus Data is Modulus of Elasticity in Tension per ASTM D 638

Expansion Loop Formula

$$L = \sqrt{\frac{3 ED (\Delta L)}{2S}}$$

Where:

- L = Loop length (in.)
- E = Modulus of elasticity at maximum temperature (psi) (Table 1)
- S = Working Stress at maximum temperature (psi) (Table 1)
- D = Outside diameter of pipe (in.) (pages 22-34)
- ΔL = Change in length due to change in temperature (in.)

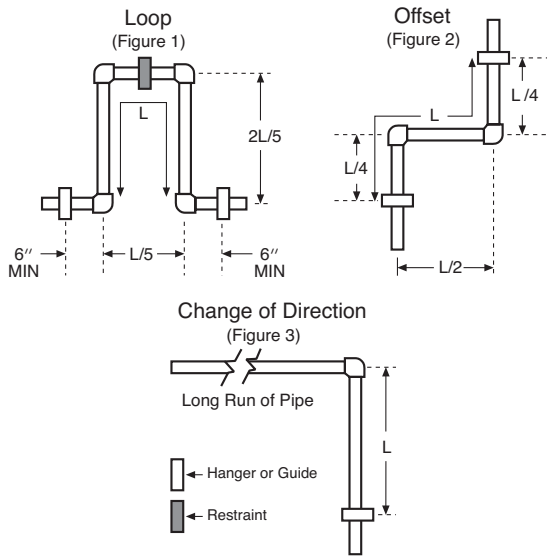

Thermal Expansion in DWV Systems

Secure above-ground vertical DWV or storm-drainage piping at sufficiently close intervals to maintain proper alignment and to support the weight of the piping and its contents. Support stack at base, and if over two stories in height, support stack at base and at each floor with approved riser clamps. Stacks should be anchored so that movement is directed to the offset or expansion joint. For vertical stacks in multi-story applications, compensation for expansion, contraction or building settling is recommended. This can be accomplished by installing a horizontal offset (Fig. 2) or expansion joint (Fig. 4) at a minimum of every other floor. Expansion joints should be installed in the neutral position. Compensation for thermal movements is usually not required for a vent system.

Note: Expansion joints are lubricated. If sand or dirt comes in contact with the lubricant, the O-rings can become damaged and leaks will result. Please keep clean until ready to use. If the expansion joint is stuck and will not move, tap lightly to break the lubricant seal.

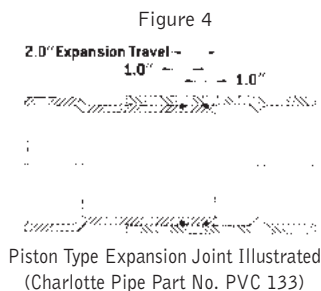

NOTICE

Failure to compensate for expansion and contraction caused by temperature change may result in system failure and property damage.

- Do not restrict expansion or contraction. Restraining movement in piping systems is not recommended and may result in joint or fitting failure.
- Use straps or clamps that allow for piping system movement.
- Align all piping system components properly without strain. Do not bend or pull pipe into position after being solvent welded.
- Do not terminate a pipe run against a stationary object (example: wall or floor joist).
- Do not install fittings under stress.

Thermal Expansion in Underground Systems

Compensation for expansion and contraction in underground applications is normally achieved by snaking the pipe in the trench. Solvent cemented joints must be used.

The following table shows recommended offsets and loop lengths for piping up to 3" nominal size.

Loop Length In Feet	Max. Temp. Variation °F, Between Installation and Final Operation									
	10°	20°	30°	40°	50°	60°	70°	80°	90°	100°
	Loop Offset In Inches									
20	3.0	3.5	4.5	5.0	6.0	6.5	7.0	7.0	8.0	8.0
50	7.0	9.0	11.0	13.0	14.0	15.5	17.0	18.0	19.0	20.0
100	13.0	18.0	22.0	26.0	29.0	31.5	35.0	37.0	40.0	42.0

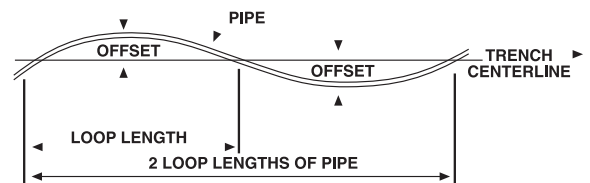

Note: This manual is not a complete engineering reference addressing all aspects of design and installation of thermal expansion in piping systems. Many excellent references are available on this topic. The American Society of Plumbing Engineers (www.ASPE.org) Data Book, Volume 4, 2008, Chapter 11 is an excellent resource for engineers on designing for thermal expansion.

Expansion and Contraction of CTS CPVC

Basic expansion loop requirements for FlowGuard Gold® and ReUze® CTS CPVC are described below. One or more expansion loops, properly sized, may be required in a single straight run. The following charts can be used to determine expansion loop and offset lengths.

**Expansion Loop Length (L), inches
for
100°F Temperature Change
Length of Run in Feet**

Nominal Dia., In.	20'	40'	60'	80'	100'
1/2	16	23	28	32	36
3/4	19	29	33	38	43
1	22	31	38	44	49
1 1/4	24	34	42	48	54
1 1/2	26	37	45	52	59
2	30	42	52	60	67

Example: Tubing Size = 1/2" Length of run = 60' L = 28" (from table)

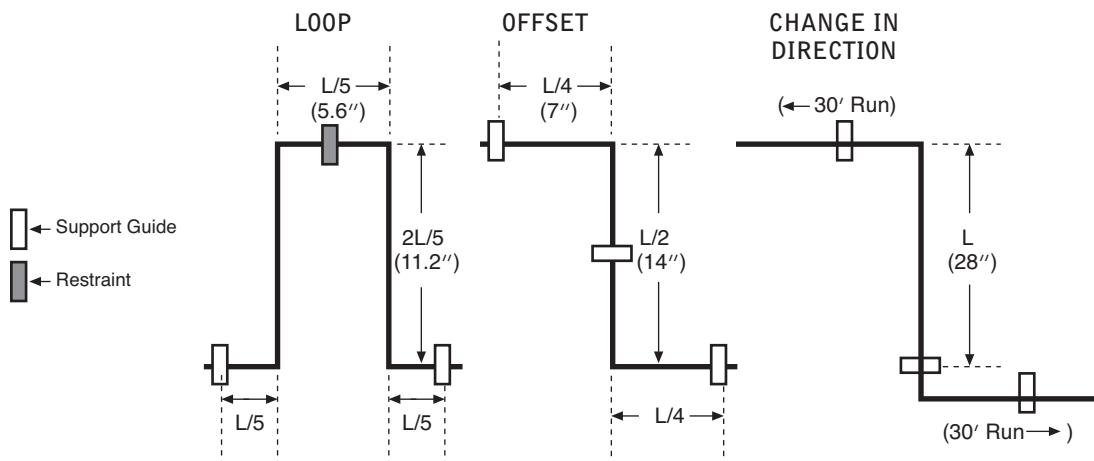

NOTICE

Failure to compensate for expansion and contraction caused by temperature change may result in system failure and property damage.

- Do not restrict expansion or contraction. Restraining movement in piping systems is not recommended and may result in joint or fitting failure.
- Use straps or clamps that allow for piping system movement.
- Align all piping system components properly without strain. Do not bend or pull pipe into position after being solvent welded.
- Do not terminate a pipe run against a stationary object (example: wall or floor joist).
- Do not install fittings under stress.

Permissible Bending Deflections for FlowGuard Gold® Pipe

FlowGuard Gold® pipe is inherently ductile allowing it to be deflected around or away from obstructions during installation. This allows for greater freedom of design and ease of installation.

NOTICE: DO NOT install fittings under stress. Pipe or tube must be properly restrained so that stress from deflected pipe is not transmitted to the fitting. The maximum installed deflection for FlowGuard Gold® CTS CPVC pipe is as follows:

FlowGuard Gold Pipe, Length in Feet, SDR 11 (ASTM D 2846)

Nominal Pipe Size (in)	Pipe Length in Feet (L)													
	2	5	7	10	12	15	17	20	25	30	35	40	45	50
	Permissible Bending Deflections (73°F) in inches - One End Restrained (d)													
½	2.1	13.2	25.8	52.6	75.8	118.4	152.1	210.6	329.0	473.8	644.8			
¾	1.5	9.4	18.4	37.6	54.1	84.6	108.7	150.4	235.0	338.4	460.6	601.6		
1	1.2	7.3	14.3	29.2	42.1	65.8	84.5	117.0	182.8	263.2	358.2	467.9	592.2	
1¼	1.0	6.0	11.7	23.9	34.5	53.8	69.1	95.7	149.5	215.3	293.1	382.8	484.5	598.2
1½	0.8	5.1	9.9	20.2	29.2	45.6	58.5	81.0	126.5	182.2	248.0	323.9	410.0	506.2
2	0.6	3.9	7.6	15.5	22.3	34.8	44.7	61.9	96.8	139.3	189.7	247.7	313.5	387.1

NOTICE

DO NOT install fittings under stress. Pipe or tube must be restrained so that stress from deflected pipe is not transmitted to the fitting. Installing fittings under stress may result in system failure and property damage.

Maximum Installed Deflections (One End Restrained)

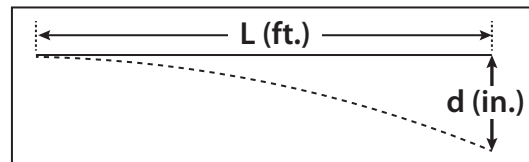

FlowGuard Gold Pipe, Length in Feet, SDR 11 (ASTM D 2846)

Nominal Pipe Size (in)	Pipe Length in Feet (L)													
	2	5	7	10	12	15	17	20	25	30	35	40	45	50
	Permissible Bending Deflections (73°F) in inches - Both Ends Restrained (d)													
½	0.5	3.3	6.4	13.2	19.0	29.6	38.0	52.7	82.3	118.5	161.2	210.6	266.6	329.1
¾	0.4	2.4	4.6	9.4	13.5	21.2	27.2	37.6	58.8	84.6	115.2	150.4	190.4	235.1
1	0.3	1.8	3.6	7.3	10.5	16.5	21.1	29.3	45.7	65.8	89.6	117.0	148.1	182.8
1¼	0.2	1.5	2.9	6.0	8.6	13.5	17.3	23.9	37.4	53.8	73.3	95.7	121.2	149.6
1½	0.2	1.3	2.5	5.1	7.3	11.4	14.6	20.3	31.6	45.6	62.0	81.0	102.5	126.6
2	0.2	1.0	1.9	3.9	5.6	8.7	11.2	15.5	24.2	34.8	47.4	61.9	78.4	96.8

Maximum Installed Deflections (Both Ends Restrained)

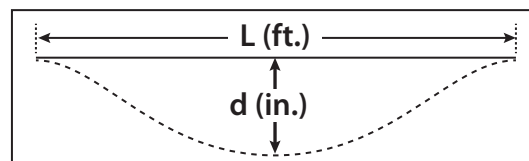

Flame Spread and Smoke Developed Rating For ABS, PVC and CPVC

ASTM E 84 is the test protocol cited in the Uniform Mechanical Code and International Mechanical Code to determine a material's suitability for installation in a plenum area.

Flame Spread and Smoke Developed Rating for ABS

- Per ASTM E 84, ABS **does not** meet the 25/50 flame and smoke requirement for plenum application.

Flame Spread and Smoke Developed Rating for PVC

- Per ASTM E 84, PVC **does not** meet the 25/50 flame and smoke requirement for plenum application.
- PVC piping systems are self extinguishing and will not support combustion.
- PVC piping systems comply with self extinguishing requirements of ASTM D 635.
- PVC piping systems meet the V-0 burning class requirements of UL 94.

Flame Spread and Smoke Developed Rating for FlowGuard Gold® CTS CPVC Pipe

- Per ASTM E 84, FlowGuard Gold CTS CPVC in sizes 1/2" through 2" water filled **does** meet the 25/50 flame and smoke requirement for plenum applications.
- FlowGuard Gold CTS CPVC piping systems comply with self extinguishing requirements of ASTM D 635.
- A third party has tested empty FlowGuard Gold CTS CPVC pipe and fittings in accordance with ASTM E 84 and the results show that 1/2" through 2" meet the 25/50 flame and smoke requirements for plenum applications.
- FlowGuard Gold CTS CPVC piping systems meet the V-0 burning class requirements of UL 94.

Flame Spread and Smoke Developed Rating for ReUze® CTS CPVC Pipe

- Per ASTM E 84, ReUze CTS CPVC in sizes 1/2" through 2" water filled **does** meet the 25/50 flame and smoke requirement for plenum applications.

NOTICE

Piping systems differ in chemical resistance. Pipe or fittings may be damaged by contact with products containing incompatible chemicals resulting in property damage.

- Verify that paints, thread sealants, lubricants, plasticized PVC products, foam insulations, caulks, leak detectors, insecticides, termiticides, antifreeze solutions, pipe sleeve, firestop materials or other materials are chemically compatible with ABS, PVC or CPVC.
- Do not use edible oils such as Crisco® for lubricant.
- Read and follow chemical manufacturer's literature before using with piping materials.

Chemical Resistance

CAUTION

PVC, ABS and CPVC piping systems have very different chemical resistance. Review manufacturer's literature for all chemicals coming into contact with the piping materials prior to use.

The following table gives the chemical resistance of ABS, PVC and CPVC thermoplastic piping materials and three commonly used seal materials. The information shown is based upon laboratory tests conducted by the manufacturers of the materials, and it is intended to provide a general guideline on the resistance of these materials to various chemicals. **NOTICE:** This table is not a guarantee, and any piping systems using products made of these materials should be tested under actual service conditions to determine their suitability for a particular purpose. See website for most current data: www.charlottepipe.com

Number = Maximum Recommended Temp. (°F)** CF = Consult Factory NR = Not Recommended •• = Incomplete Data

Chemical Name	Pipe & Fitting Materials Recommended Max. Temp (°F)			Seal Materials Recommended Max. Temp. (°F)		
	ABS	PVC	CPVC	Viton ®	EPDM	Neoprene
Acetaldehyde.....	NR	NR	NR	NR	200	NR
Acetamide.....	120	••	••	NR	200	NR
Acetate Solvent, Crude	NR	NR	NR	••	••	••
Acetate Solvent, Pure	NR	NR	NR	••	••	••
Acetic Acid, 10%	120	140	180	NR	180	NR
Acetic Acid, 20%	NR	140	NR	NR	180	NR
Acetic Acid, 50%	NR	73	NR	NR	140	NR
Acetic Acid, 80%	NR	73	NR	NR	100	NR
Acetic Acid, Glacial	NR	NR	NR	NR	100	NR
Acetic Anhydride	NR	NR	NR	NR	NR	70
Acetone	NR	NR	NR	NR	130	NR
Acetonitrile.....	NR	NR	NR	NR	NR	70
Acetophenone	NR	NR	NR	NR	140	NR
Acetyl Chloride	NR	NR	NR	185	NR	NR
Acetylene	140§	140§	180§	200	200	70
Acetyl Nitrile.....	NR	NR	NR	NR	NR	NR
Acrylic Acid.....	NR	NR	NR	••	••	••
Acrylonitrile.....	NR	NR	NR	NR	NR	NR
Adipic Acid (Sat'd)	••	140	180	200	200	200
Alcohol, Allyl	NR	NR	NR	100	70	70
Alcohol, Amyl.....	NR	NR	NR	185	200	140
Alcohol, Benzyl	NR	NR	NR	140	NR	NR
Alcohol, Butyl	73	100	NR	75	200	140
Alcohol, Diacetone	NR	NR	NR	NR	70	NR
Alcohol, Ethyl (Ethanol) Up to 5%	NR	140	180	••	••	••
Alcohol, Ethyl (Ethanol) Over 5%.....	NR	140	NR	••	••	••
Alcohol, Hexyl (Hexanol)	NR	100	NR	160	NR	70
Alcohol, Isopropanol.....	NR	140	NR	••	••	••
Alcohol, Isopropyl.....	NR	140	NR	160	140	70
Alcohol, Methyl (Methanol).....	NR	140	NR	NR	140	140
Alcohol, Octyl (1-n-Octanol).....	NR	••	NR	••	••	••
Alcohol, Propyl (Propanol) Up to 0.5%.....	NR	••	180	••	••	••
Alcohol, Propyl (Propanol) Over 0.5%..	NR	••	NR	••	••	••
Alcohol, Propyl.....	NR	140	NR	••	140	140
Allyl Alcohol	NR	NR	NR	100	70	70

Acrylonitrile-Butadiene-Styrene Polyvinyl Chloride Type 1 Grade 1 Chlorinated Polyvinyl Chloride Type IV Grade 1
Fluorocarbon Elastomer (Viton ® is a registered trademark of the DuPont Co.) Ethylene Propylene Diene Monomer
** Maximum recommended temperature, for chemical resistance, under normal conditions. § Non-pressure, vent-only, applications when chemical is in gas form.

Chemical Resistance

The following table gives the chemical resistance of ABS, PVC and CPVC thermoplastic piping materials and three commonly used seal materials. The information shown is based upon laboratory tests conducted by the manufacturers of the materials, and it is intended to provide a general guideline on the resistance of these materials to various chemicals. **NOTICE:** This table is not a guarantee, and any piping systems using products made of these materials should be tested under actual service conditions to determine their suitability for a particular purpose. See website for most current data: www.charlottepipe.com

Number = Maximum Recommended Temp. (°F)** CF = Consult Factory NR = Not Recommended • • = Incomplete Data

Chemical Name	Pipe & Fitting Materials Recommended Max. Temp (°F)			Seal Materials Recommended Max. Temp. (°F)		
	ABS	PVC	CPVC	Viton®	EPDM	Neoprene
Allyl Chloride	NR	NR	NR	70	NR	• •
Alums	140	140	180	NR	200	160
Aluminum Acetate	140	• •	180	NR	200	NR
Aluminum Ammonium	• •	140	180	200	200	160
Aluminum Chloride	140	140	180	200	200	160
Aluminum Chrome	• •	140	180	200	200	160
Aluminum Fluoride	NR	73	180	200	200	160
Aluminum Hydroxide	140	140	180	200	200	100
Aluminum Nitrate	140	140	180	100	200	100
Aluminum Oxychloride	140	140	180	NR	• •	• •
Aluminum Potassium Sulfate	140	140	180	200	200	160
Aluminum Sulfate	140	140	180	185	200	140
Amines.....	NR	• •	NR	• •	• •	• •
Ammonia	73	140	NR	NR	175	150
Ammonia, Gas	140§	140§	NR	NR	140	140
Ammonia, Aqua, 10%	• •	73	NR	NR	140	• •
Ammonia, (25% Aqueous Solution)	140	NR	NR	NR	140	• •
Ammonia Hydroxide	73	100	NR	NR	175	150
Ammonia Liquid (Concentrated)	NR	NR	NR	NR	140	70
Ammonium Acetate	• •	140	180	73	140	140
Ammonium Benzoate.....	• •	• •	180	• •	• •	• •
Ammonium Bifluoride	• •	140	180	200	200	• •
Ammonium Bisulfide.....	140	140	180	• •	• •	• •
Ammonium Carbonate	140	140	180	200	200	140
Ammonium Chloride	120	140	180	200	200	160
Ammonium Citrate	120	• •	180	• •	• •	• •
Ammonium Dichromate	120	73	• •	• •	70	100
Ammonium Fluoride, 10%	120	140	180	• •	200	100
Ammonium Fluoride, 25%	120	73	180	• •	140	• •
Ammonium Hydroxide	120	73	NR	70	200	150
Ammonium Metaphosphate.....	120	140	180	200	200	• •
Ammonium Nitrate	120	140	180	100	200	160
Ammonium Persulphate	120	140	73	• •	200	70
Ammonium Phospate	120	140	73	185	200	140
Ammonium Sulfamate	120	• •	180	• •	• •	• •

Acrylonitrile-Butadiene-Styrene Polyvinyl Chloride Type 1 Grade 1 Chlorinated Polyvinyl Chloride Type IV Grade 1 Fluorocarbon Elastomer (Viton® is a registered trademark of the DuPont Co.) Ethylene Propylene Diene Monomer

** Maximum recommended temperature, for chemical resistance, under normal conditions. § Non-pressure, vent-only, applications when chemical is in gas form.

Chemical Resistance

CAUTION

PVC, ABS and CPVC piping systems have very different chemical resistance. Review manufacturer's literature for all chemicals coming into contact with the piping materials prior to use.

The following table gives the chemical resistance of ABS, PVC and CPVC thermoplastic piping materials and three commonly used seal materials. The information shown is based upon laboratory tests conducted by the manufacturers of the materials, and it is intended to provide a general guideline on the resistance of these materials to various chemicals. **NOTICE:** This table is not a guarantee, and any piping systems using products made of these materials should be tested under actual service conditions to determine their suitability for a particular purpose. See website for most current data: www.charlottepipe.com

Number = Maximum Recommended Temp. (°F)** CF = Consult Factory NR = Not Recommended •• = Incomplete Data

Chemical Name	Pipe & Fitting Materials Recommended Max. Temp (°F)			Seal Materials Recommended Max. Temp. (°F)		
	ABS	PVC	CPVC	Viton ®	EPDM	Neoprene
Ammonium Sulfate	120	140	180	200	200	160
Ammonium Sulfide	120	73	180	200	200	••
Ammonium Thiocyanate	120	140	180	185	••	70
Ammonium Tartrate.....	120	140	180	••	••	••
Amyl Acetate	NR	NR	NR	NR	70	NR
Alcohol, Amyl.....	NR	NR	NR	185	200	140
Amyl Chloride	NR	NR	NR	200	NR	NR
Aniline	NR	NR	NR	NR	140	NR
Aniline Chlorohydrate	NR	NR	••	••	••	••
Aniline Hydrochloride	NR	NR	NR	185	••	NR
Anthraquinone Sulfonic Acid.....	••	140	••	200	••	••
Anti-Freeze (See Alcohols, Glycols & Glycerin)						
Antimony Trichloride	••	140	180	185	140	140
Aqua Regia.....	NR	NR	73	100	NR	NR
Aromatic Hydrocarbons	NR	NR	NR	73	NR	NR
Argon.....	••	••	••	200	200	100
Arsenic Acid	••	140	73	200	185	NR
Aryl Sulfonic Acid	••	140	••	185	140	••
Asphalt	NR	NR	NR	180	NR	NR
Barium Carbonate	120	140	180	200	200	160
Barium Chloride	120	140	180	200	200	160
Barium Hydroxide	120	140	180	200	180	150
Barium Nitrate.....	120	73	180	200	200	160
Barium Sulfate.....	120	140	180	200	200	160
Barium Sulfide	120	140	180	200	140	160
Beer	120	140	180	200	200	140
Beet Sugar Liquids	120	140	180	185	200	160
Benzaldehyde	NR	NR	NR	NR	140	NR
Benzalkonium Chloride	NR	NR	NR	••	••	••
Benzene	NR	NR	NR	150	NR	NR
Benzene, Benzol	NR	NR	NR	200	200	••
Benzene Sulfonic Acid	NR	NR	NR	185	NR	100
Benzoic Acid, (Sat'd)	140	140	73	••	NR	160
Benzyl Chloride	NR	••	NR	••	••	••
Benzyl Alcohol	NR	NR	NR	140	NR	NR

Acrylonitrile-Butadiene-Styrene Polyvinyl Chloride Type 1 Grade 1 Chlorinated Polyvinyl Chloride Type IV Grade 1
Fluorocarbon Elastomer (Viton ® is a registered trademark of the DuPont Co.) Ethylene Propylene Diene Monomer

** Maximum recommended temperature, for chemical resistance, under normal conditions. § Non-pressure, vent-only, applications when chemical is in gas form.

Chemical Resistance

The following table gives the chemical resistance of ABS, PVC and CPVC thermoplastic piping materials and three commonly used seal materials. The information shown is based upon laboratory tests conducted by the manufacturers of the materials, and it is intended to provide a general guideline on the resistance of these materials to various chemicals. **NOTICE:** This table is not a guarantee, and any piping systems using products made of these materials should be tested under actual service conditions to determine their suitability for a particular purpose. See website for most current data: www.charlottepipe.com

Number = Maximum Recommended Temp. (°F)** CF = Consult Factory NR = Not Recommended •• = Incomplete Data

Chemical Name	Pipe & Fitting Materials Recommended Max. Temp (°F)			Seal Materials Recommended Max. Temp. (°F)		
	ABS	PVC	CPVC	Viton®	EPDM	Neoprene
Bismuth Carbonate	140	140	180	••	••	70
Black Liquor	73	140	180	200	180	70
Bleach, Industrial (15% Cl ₂)	73	140	180	185	70	••
Bleach, 12.5% Active Cl ₂	73	140	180	R	140	••
Bleach, 5.5% Active Cl ₂	73	140	180	R	140	••
Borax	140	140	180	185	140	140
Boric Acid	140	140	180	185	140	140
Breeders Pellets, Deriv. Fish.....	140	140	180	••	••	••
Brine, Acid	73	73	180	200	200	160
Bromic Acid	73	140	180	70	70	••
Bromine	NR	NR	NR	70	NR	NR
Bromine, Liquid	NR	NR	NR	70	NR	NR
Bromine, Vapor 25%	NR	140	••	••	NR	••
Bromine, Water.....	NR	73	73	185	NR	NR
Bromine, Water, (Sat'd).....	NR	73	73	••	••	••
Bromobenzene.....	NR	NR	NR	150	NR	NR
Bromotoluene.....	NR	NR	NR	NR	NR	NR
Butadiene.....	NR	140	73	185	NR	140
Butane	NR	140	••	185	NR	70
Butanol, Primary.....	NR	NR	NR	••	••	••
Butanol, Secondary	NR	NR	NR	••	••	••
Butyl Acetate	NR	NR	NR	NR	140	NR
Butyl Alcohol	73	100	NR	75	200	140
Butyl Carbitol.....	••	••	NR	••	••	••
Butyl Cellosolve (2-butoxyethanol)	NR	73	NR	NR	140	••
Butynediol.....	NR	73	••	••	••	••
Butylene	NR	73	••	100	NR	NR
Butyl Phenol	NR	73	••	••	••	NR
Butyl Pthalate	NR	NR	NR	70	••	••
Butyl Stearate.....	NR	73	73	200	NR	NR
Butyric Acid	NR	NR	NR	70	140	NR
Butyric Acid, Up to 1%.....	73	73	180	73	140	••
Butyric Acid, Over 1%	NR	••	NR	••	••	••
Cadmium Acetate	••	••	180	••	••	••
Cadmium Chloride.....	••	••	180	••	••	••

Acrylonitrile-Butadiene-Styrene Polyvinyl Chloride Type 1 Grade 1 Chlorinated Polyvinyl Chloride Type IV Grade 1
Fluorocarbon Elastomer (Viton® is a registered trademark of the DuPont Co.) Ethylene Propylene Diene Monomer

** Maximum recommended temperature, for chemical resistance, under normal conditions. § Non-pressure, vent-only, applications when chemical is in gas form.

Chemical Resistance

CAUTION

PVC, ABS and CPVC piping systems have very different chemical resistance. Review manufacturer's literature for all chemicals coming into contact with the piping materials prior to use.

The following table gives the chemical resistance of ABS, PVC and CPVC thermoplastic piping materials and three commonly used seal materials. The information shown is based upon laboratory tests conducted by the manufacturers of the materials, and it is intended to provide a general guideline on the resistance of these materials to various chemicals. **NOTICE:** This table is not a guarantee, and any piping systems using products made of these materials should be tested under actual service conditions to determine their suitability for a particular purpose. See website for most current data: www.charlottepipe.com

Number = Maximum Recommended Temp. (°F)** CF = Consult Factory NR = Not Recommended •• = Incomplete Data

Chemical Name	Pipe & Fitting Materials Recommended Max. Temp (°F)			Seal Materials Recommended Max. Temp. (°F)		
	ABS	PVC	CPVC	Viton®	EPDM	Neoprene
Cadmium Cyanide.....	••	140	180	••	••	70
Cadmium Sulfate.....	••	••	180	••	••	••
Caffeine Citrate.....	••	73	••	••	••	••
Calcium Acetate.....	NR	73	180	••	R	••
Calcium Bisulfide.....	NR	NR	180	185	••	••
Calcium Bisulfite.....	NR	140	180	185	NR	70
Calcium Carbonate.....	140	140	180	200	200	70
Calcium Chlorate.....	140	140	180	185	140	70
Calcium Chloride.....	140	140	180	200	200	160
Calcium Hydroxide.....	140	140	180	200	200	70
Calcium Hypochlorite.....	140	140	180	185	70	••
Calcium Nitrate.....	140	140	180	200	200	100
Calcium Oxide.....	140	140	180	••	200	160
Calcium Sulfate.....	140	140	180	200	200	160
Camphor Crystals.....	NR	73	••	200	200	NR
Cane Sugar Liquors.....	120	140	180	200	200	160
Caprolactam.....	NR	••	NR	••	••	••
Caprolactone.....	NR	••	NR	••	••	••
Caprylic Acid.....	NR	••	NR	••	••	••
Carbitol™.....	NR	NR	NR	70	140	70
Carbon Bisulfide.....	NR	NR	NR	••	••	••
Carbon Dioxide, Wet.....	140	140	180	200	200	160
Carbon Dioxide, Dry.....	140	140	180	200	200	160
Carbon Disulfide.....	NR	NR	NR	200	NR	NR
Carbonic Acid.....	••	140	180	200	200	70
Carbon Monoxide.....	140	140	180	200	200	70
Carbon Tetrachloride.....	NR	NR	NR	185	NR	NR
Castor Oil.....	NR	140	NR	••	140	100
Caustic Potash.....	140	140	CF	NR	140	160
Caustic Soda.....	140	140	CF	NR	70	100
Cellosolve.....	NR	73	NR	NR	140	••
Cellosolve Acetate.....	NR	••	NR	NR	140	NR
Chloroacetic Acid.....	73	73	180	NR	73	••
Chloroacetyl Chloride.....	NR	73	••	••	••	••
Chloral Hydrate.....	••	140	180	NR	••	70

Acrylonitrile-Butadiene-Styrene Polyvinyl Chloride Type 1 Grade 1 Chlorinated Polyvinyl Chloride Type IV Grade 1
 Fluorocarbon Elastomer (Viton® is a registered trademark of the DuPont Co.) Ethylene Propylene Diene Monomer
 ** Maximum recommended temperature, for chemical resistance, under normal conditions. § Non-pressure, vent-only, applications when chemical is in gas form.

Chemical Resistance

The following table gives the chemical resistance of ABS, PVC and CPVC thermoplastic piping materials and three commonly used seal materials. The information shown is based upon laboratory tests conducted by the manufacturers of the materials, and it is intended to provide a general guideline on the resistance of these materials to various chemicals. **NOTICE:** This table is not a guarantee, and any piping systems using products made of these materials should be tested under actual service conditions to determine their suitability for a particular purpose. See website for most current data: www.charlottepipe.com

Number = Maximum Recommended Temp. (°F)** CF = Consult Factory NR = Not Recommended •• = Incomplete Data

Chemical Name	Pipe & Fitting Materials Recommended Max. Temp (°F)			Seal Materials Recommended Max. Temp. (°F)		
	ABS	PVC	CPVC	Viton®	EPDM	Neoprene
Chloramine.....	NR	73	••	••	••	70
Chloric Acid, 20%	••	140	180	140	••	140
Chlorinated Solvents.....	NR	NR	NR	••	••	••
Chlorinated Water, Up to 3500 ppm.....	140	140	CF	185	100	NR
Chlorinated Water, Above 3500 ppm.....	NR	NR	NR	185	NR	NR
Chlorine Gas, Dry	NR	NR	NR	185	NR	NR
Chlorine Gas, Wet	NR	NR	NR	185	NR	NR
Chlorine, Liquid	NR	NR	NR	100	NR	••
Chlorine, trace in air.....	••	••	180§	••	••	••
Chlorine Dioxide (sat'd aqueous sol.).....	••	••	180	••	••	••
Chlorine Water, (Sat'd).....	••	140	180	200	73	••
Chlorobenzene	NR	NR	NR	70	NR	NR
Chlorobenzene Chloride.....	NR	NR	NR	200	••	••
Chloroform.....	NR	NR	NR	70	NR	NR
Chloropicrin	NR	NR	NR	••	••	••
Chlorosulfonic Acid.....	••	73	73	NR	NR	NR
Chlorox Bleach Solution, 5.5% Cl ₂	73	140	180	200	140	••
Chromic Acid, 10%	73	140	180	140	70	NR
Chromic Acid, 30%	NR	73	180	140	NR	NR
Chromic Acid, 40%	NR	73	180	140	NR	NR
Chromic Acid, 50%	NR	75	140	140	NR	NR
Chromium Nitrate	••	••	180	••	••	••
Chromium Potassium Nitrate.....	73	73	73	200	140	160
Citric Acid (Sat'd).....	140	140	180	200	200	140
Citric Acid, 10%.....	140	140	180	••	••	••
Citrus Oils.....	••	••	NR	••	••	••
Coconut Oil	NR	140	NR	185	NR	100
Coke Oven Gas	NR	NR	NR	185	70	••
Copper Acetate, (Sat'd)	73	73	73	140	100	160
Copper Carbonate.....	120	140	180	185	200	••
Copper Chloride	73	140	180	200	200	160
Copper Cyanide	73	140	180	185	200	160
Copper Fluoride	73	140	180	185	200	140
Copper Nitrate	120	140	180	200	200	160
Copper Salts.....	140	140	180	••	••	••

Acrylonitrile-Butadiene-Styrene Polyvinyl Chloride Type 1 Grade 1 Chlorinated Polyvinyl Chloride Type IV Grade 1

Fluorocarbon Elastomer (Viton® is a registered trademark of the DuPont Co.) Ethylene Propylene Diene Monomer

** Maximum recommended temperature, for chemical resistance, under normal conditions. § Non-pressure, vent-only, applications when chemical is in gas form.

Chemical Resistance

⚠ CAUTION

PVC, ABS and CPVC piping systems have very different chemical resistance. Review manufacturer's literature for all chemicals coming into contact with the piping materials prior to use.

The following table gives the chemical resistance of ABS, PVC and CPVC thermoplastic piping materials and three commonly used seal materials. The information shown is based upon laboratory tests conducted by the manufacturers of the materials, and it is intended to provide a general guideline on the resistance of these materials to various chemicals. **NOTICE:** This table is not a guarantee, and any piping systems using products made of these materials should be tested under actual service conditions to determine their suitability for a particular purpose. See website for most current data: www.charlottepipe.com

Number = Maximum Recommended Temp. (°F)** CF = Consult Factory NR = Not Recommended •• = Incomplete Data

Chemical Name	Pipe & Fitting Materials Recommended Max. Temp (°F)			Seal Materials Recommended Max. Temp. (°F)		
	ABS	PVC	CPVC	Viton®	EPDM	Neoprene
Copper Sulfate	140	140	180	200	200	160
Corn Oil	73	140	NR	200	NR	NR
Corn Syrup.....	120	140	180	185	••	100
Cottonseed Oil	120	140	NR	185	NR	••
Creosote.....	NR	NR	NR	73	NR	NR
Cresol	NR	NR	NR	100	NR	NR
Cresylic Acid, 50%	NR	140	NR	185	NR	NR
Crotonaldehyde.....	NR	NR	NR	NR	NR	70
Crude Oil	NR	73	180	200	NR	••
Cumene.....	••	••	••	200	NR	NR
Cupric Fluoride.....	73	140	180	••	200	••
Cupric Sulfate	140	140	180	200	200	160
Cuprous Chloride	73	140	180	200	200	70
Cyclohexane	NR	NR	NR	185	NR	NR
Cyclohexanol	NR	NR	NR	185	NR	NR
Cyclohexanone	NR	NR	NR	NR	70	NR
Decalin.....	NR	NR	NR	••	••	••
D-Limonene.....	••	••	NR	••	••	••
Desocypheдрine	••	73	••	••	••	••
Detergents	73	140	NR	200	200	160
Detergent Solution, Heavy Duty.....	73	140	NR	200	200	160
Dextrine	••	140	180	200	NR	••
Dextrose	120	140	180	200	140	160
Diacetone Alcohol	NR	NR	NR	NR	70	NR
Diazo Salts.....	••	140	180	••	••	••
Dibutoxy Ethyl Phthalate	NR	NR	NR	200	70	NR
Dibutyl Ethyl Phthalate.....	NR	NR	NR	200	70	NR
Dibutyl Phthalate	NR	NR	NR	NR	70	NR
Dibutyl Sebacate	NR	NR	NR	NR	70	NR
Dichlorobenzene	NR	NR	NR	150	NR	NR
Dichloroethylene.....	NR	NR	NR	185	NR	NR
Diesel Fuels	NR	73	NR	185	NR	NR
Diethylamine	NR	NR	NR	NR	70	••
Diethyl Cellosolve	NR	••	NR	200	NR	100
Diethyl Ether.....	NR	NR	NR	NR	NR	••

Acrylonitrile-Butadiene-Styrene Polyvinyl Chloride Type 1 Grade 1 Chlorinated Polyvinyl Chloride Type IV Grade 1
Fluorocarbon Elastomer (Viton® is a registered trademark of the DuPont Co.) Ethylene Propylene Diene Monomer

** Maximum recommended temperature, for chemical resistance, under normal conditions. § Non-pressure, vent-only, applications when chemical is in gas form.

Chemical Resistance

The following table gives the chemical resistance of ABS, PVC and CPVC thermoplastic piping materials and three commonly used seal materials. The information shown is based upon laboratory tests conducted by the manufacturers of the materials, and it is intended to provide a general guideline on the resistance of these materials to various chemicals. **NOTICE:** This table is not a guarantee, and any piping systems using products made of these materials should be tested under actual service conditions to determine their suitability for a particular purpose. See website for most current data: www.charlottepipe.com

Number = Maximum Recommended Temp. (°F)** CF = Consult Factory NR = Not Recommended •• = Incomplete Data

Chemical Name	Pipe & Fitting Materials Recommended Max. Temp (°F)			Seal Materials Recommended Max. Temp. (°F)		
	ABS	PVC	CPVC	Viton®	EPDM	Neoprene
Diglycolic Acid	NR	140	••	70	70	••
Dill Oil	••	••	NR	••	••	••
Dimethylamine	NR	140	NR	NR	140	NR
Dimethylformamide	NR	NR	NR	NR	NR	NR
Dimethyl Hydrazine	NR	NR	NR	NR	••	••
Diethyl Phthalate (DEHP)	NR	NR	NR	70	70	NR
Dioxane	NR	NR	NR	NR	70	NR
Dioxane, 1.4	NR	NR	NR	NR	73	••
Disodium Phosphate	120	140	180	••	200	••
Distilled Water	140	140	180	200	200	160
Divinylbenzene.....	NR	NR	NR	200	NR	••
Dry Cleaning Fluid.....	NR	NR	NR	200	NR	NR
Dursban TC	NR	••	NR	••	••	••
EDTA, Tetrasodium	••	••	180	••	••	••
Epsom Salt	120	140	180	••	200	••
Epichlorohydrin.....	NR	NR	NR	••	••	••
Esters	NR	NR	NR	••	••	••
Ethanol, Up to 5%	NR	140	180	••	••	••
Ethanol, Over 5%	NR	140	NR	••	••	••
Ethers	NR	NR	NR	NR	••	NR
Ethyl Acetate	NR	NR	NR	NR	70	NR
Ethyl Acetoacetate	NR	NR	NR	NR	100	••
Ethyl Acrylate.....	NR	NR	NR	NR	70	NR
Ethyl Benzene	NR	NR	NR	70	NR	NR
Ethyl Chloride	NR	NR	NR	140	70	70
Ethyl Chloroacetate	NR	NR	NR	••	••	••
Ethylene Bromide	NR	NR	NR	70	NR	NR
Ethylene Chloride	NR	NR	NR	70	••	••
Ethylene Chlorohydrin	NR	NR	NR	NR	70	70
Ethylene Diamine	NR	NR	NR	••	70	100
Ethylene Dichloride	NR	NR	NR	120	NR	NR
Ethyl Ether	NR	NR	NR	NR	NR	NR
Ethylene Glycol, Up to 50%	73	140	180	200	200	160
Ethylene Glycol, Over 50%	73	140	NR	200	200	160
Ethylene Oxide	NR	NR	NR	NR	NR	NR

Acrylonitrile-Butadiene-Styrene Polyvinyl Chloride Type 1 Grade 1 Chlorinated Polyvinyl Chloride Type IV Grade 1
Fluorocarbon Elastomer (Viton® is a registered trademark of the DuPont Co.) Ethylene Propylene Diene Monomer

** Maximum recommended temperature, for chemical resistance, under normal conditions. § Non-pressure, vent-only, applications when chemical is in gas form.

Chemical Resistance

CAUTION

PVC, ABS and CPVC piping systems have very different chemical resistance. Review manufacturer's literature for all chemicals coming into contact with the piping materials prior to use.

The following table gives the chemical resistance of ABS, PVC and CPVC thermoplastic piping materials and three commonly used seal materials. The information shown is based upon laboratory tests conducted by the manufacturers of the materials, and it is intended to provide a general guideline on the resistance of these materials to various chemicals. **NOTICE:** This table is not a guarantee, and any piping systems using products made of these materials should be tested under actual service conditions to determine their suitability for a particular purpose. See website for most current data: www.charlottepipe.com

Number = Maximum Recommended Temp. (°F)** CF = Consult Factory NR = Not Recommended •• = Incomplete Data

Chemical Name	Pipe & Fitting Materials Recommended Max. Temp (°F)			Seal Materials Recommended Max. Temp. (°F)		
	ABS	PVC	CPVC	Viton ®	EPDM	Neoprene
Fatty Acids.....	140	140	73	185	NR	140
Ferric Acetate	NR	73	180	••	••	••
Ferric Chloride	120	140	180	200	200	160
Ferric Hydroxide	140	140	180	180	180	100
Ferric Nitrate.....	140	140	180	200	200	160
Ferric Sulfate.....	140	140	180	185	200	140
Ferrous Chloride.....	140	140	180	200	200	••
Ferrous Hydroxide.....	140	73	180	180	180	••
Ferrous Nitrate.....	140	73	140	200	180	160
Ferrous Sulfate.....	140	140	180	200	200	160
Fish Solubles	140	140	180	70	NR	••
Fluorine Gas.....	NR	NR	NR	NR	NR	NR
Fluoboric Acid.....	••	140	73	140	140	160
Fluosilicic Acid, 30%.....	73	140	73	200	140	100
Formaldehyde, 35%	NR	140	NR	NR	140	140
Formalin (37% to 50% Formaldehyde)	NR	140	NR	NR	140	140
Formic Acid, Up to 25%	••	73	180	NR	200	140
Formic Acid, Anhydrous	••	73	NR	NR	••	100
Freon F- 11.....	••	140§	73§	70	NR	NR
Freon F-12.....	••	140§	73§	NR	NR	130
Freon F-21.....	••	NR	NR	NR	NR	NR
Freon F-22	••	NR	NR	NR	NR	130
Freon F-113.....	••	140§	••	130	NR	130
Freon F-114.....	••	140§	••	NR	NR	70
Fructose.....	120	140	180	200	175	160
Fruit Juices, Pulp	73	140	180	200	••	••
Furfural	NR	NR	NR	NR	140	70
Gallic Acid.....	••	140	73	185	70	70
Gas, Manufactured	NR	73§	NR	••	••	••
Gas, Natural.....	NR	140§	••	185	NR	140
Gasoline, Leaded	NR	NR	NR	100	NR	70
Gasoline, Unleaded	NR	NR	NR	100	NR	••
Gasoline, Sour.....	NR	NR	NR	100	NR	••
Gasoline, Refined.....	NR	NR	NR	••	••	••
Gelatin	120	140	150	200	200	160

Acrylonitrile-Butadiene-Styrene Polyvinyl Chloride Type 1 Grade 1 Chlorinated Polyvinyl Chloride Type IV Grade 1
Fluorocarbon Elastomer (Viton ® is a registered trademark of the DuPont Co.) Ethylene Propylene Diene Monomer

** Maximum recommended temperature, for chemical resistance, under normal conditions. § Non-pressure, vent-only, applications when chemical is in gas form.

Chemical Resistance

The following table gives the chemical resistance of ABS, PVC and CPVC thermoplastic piping materials and three commonly used seal materials. The information shown is based upon laboratory tests conducted by the manufacturers of the materials, and it is intended to provide a general guideline on the resistance of these materials to various chemicals. **NOTICE:** This table is not a guarantee, and any piping systems using products made of these materials should be tested under actual service conditions to determine their suitability for a particular purpose. See website for most current data: www.charlottepipe.com

Number = Maximum Recommended Temp. (°F)** CF = Consult Factory NR = Not Recommended •• = Incomplete Data

Chemical Name	Pipe & Fitting Materials Recommended Max. Temp (°F)			Seal Materials Recommended Max. Temp. (°F)		
	ABS	PVC	CPVC	Viton®	EPDM	Neoprene
Gin.....	NR	140	NR	••	••	••
Glucose	120	140	180	200	200	160
Glycerine.....	120	140	180	200	200	160
Glycerine, Glycerol	120	140	180	200	200	••
Glycol, Ethylene, Up to 50%	73	140	180	200	200	160
Glycol, Ethylene, Over 50%	73	140	NR	200	200	160
Glycol, Polyethylene	••	••	NR	••	••	••
Glycol, Polypropylene.....	••	••	NR	••	••	••
Glycol, Propylene, Up to 25%	73	140	180	140	70	100
Glycol, Propylene, Up to 50%	73	140	NR	140	70	100
Glycolic Acid.....	••	140	NR	NR	••	70
Glycol Ethers.....	NR	140	NR	••	••	••
Grape Sugar, Juice	73	140	180	185	200	160
Green Liquor	140	140	180	••	150	70
Halocarbons Oils	NR	••	NR	••	••	••
Heptane	73	140	NR	185	NR	70
Hexane.....	NR	73	73	70	NR	70
Hexanol	NR	100	NR	160	NR	70
Hydraulic Oil.....	NR	73	••	200	NR	70
Hydrazine.....	NR	NR	NR	NR	70	••
Hydrobromic Acid, Dilute.....	73	140	180	R	140	••
Hydrobromic Acid, 20%	73	140	73	185	140	70
Hydrobromic Acid, 50%	NR	140	73	185	140	70
Hydrochloric Acid, Dilute.....	73	140	180	NR	150	••
Hydrochloric Acid, 18%.....	NR	140	180	NR	150	••
Hydrochloric Acid, 20%.....	NR	140	180	NR	150	••
Hydrochloric Acid Conc., 37%	NR	140	180	NR	150	••
Hydrocyanic Acid, 10%	140	140	••	185	200	••
Hydrofluoric Acid, Dilute	NR	73	73	150	NR	70
Hydrofluoric Acid, Up to 3%.....	73	73	73	150	NR	70
Hydrofluoric Acid, 30%	NR	73	NR	150	NR	70
Hydrofluoric Acid, 40%	NR	73	NR	100	NR	NR
Hydrofluoric Acid, 50%	NR	73	NR	75	NR	NR
Hydrofluoric Acid, 100%	NR	NR	NR	NR	NR	NR
Hydrofluosilicic Acid, 50%	NR	140	140	200	140	••

Acrylonitrile-Butadiene-Styrene Polyvinyl Chloride Type 1 Grade 1 Chlorinated Polyvinyl Chloride Type IV Grade 1
Fluorocarbon Elastomer (Viton® is a registered trademark of the DuPont Co.) Ethylene Propylene Diene Monomer

** Maximum recommended temperature, for chemical resistance, under normal conditions. § Non-pressure, vent-only, applications when chemical is in gas form.

Chemical Resistance

CAUTION

PVC, ABS and CPVC piping systems have very different chemical resistance. Review manufacturer's literature for all chemicals coming into contact with the piping materials prior to use.

The following table gives the chemical resistance of ABS, PVC and CPVC thermoplastic piping materials and three commonly used seal materials. The information shown is based upon laboratory tests conducted by the manufacturers of the materials, and it is intended to provide a general guideline on the resistance of these materials to various chemicals. **NOTICE:** This table is not a guarantee, and any piping systems using products made of these materials should be tested under actual service conditions to determine their suitability for a particular purpose. See website for most current data: www.charlottepipe.com

Number = Maximum Recommended Temp. (°F)** CF = Consult Factory NR = Not Recommended •• = Incomplete Data

Chemical Name	Pipe & Fitting Materials Recommended Max. Temp (°F)			Seal Materials Recommended Max. Temp. (°F)		
	ABS	PVC	CPVC	Viton ®	EPDM	Neoprene
Hydrogen	140§	140§	73§	200	200	160
Hydrogen Cyanide.....	••	140	••	••	••	70
Hydrogen Fluoride.....	NR	NR	NR	NR	70	NR
Hydrogen Peroxide, Dilute	73	140	73	200	140	NR
Hydrogen Peroxide, 30%	NR	140	73	200	140	NR
Hydrogen Peroxide, 50%	NR	140	73	185	100	NR
Hydrogen Peroxide, 90%	NR	NR	NR	100	NR	NR
Hydrogen Phosphide	••	140	••	••	73	••
Hydrogen Sulfide, Dry	••	140	180	140	100	NR
Hydrogen Sulfide, Aqueous Sol.	••	140	180	140	100	NR
Hydroquinone	••	140	••	185	NR	NR
Hydroxylamine Sulfate	••	140	••	••	70	70
Hypochlorous Acid	73	140	CF	70	70	••
Iodine	NR	NR	NR	70	70	NR
Iodine Solution, 10%.....	NR	NR	NR	200	150	••
Iodine in Alcohol	NR	NR	NR	••	••	••
Iron Salts.....	••	••	180	••	••	••
Isopropanol	NR	140	NR	••	••	••
Isopropyl Alcohol.....	NR	140	NR	160	140	70
Isopropyl Ether	NR	NR	NR	NR	NR	NR
Isooctane	NR	NR	NR	185	NR	70
Jet Fuel, JP-4.....	NR	NR	NR	200	NR	NR
Jet Fuel, JP-5.....	NR	NR	NR	200	NR	NR
Kerosene	NR	NR	NR	200	NR	70
Ketones.....	NR	NR	NR	NR	NR	NR
Kraft Liquor.....	73	140	180	100	••	70
Lactic Acid, 25%.....	73	140	180	70	70	140
Lactic Acid, 80%.....	NR	73	73	70	70	••
Lard Oil	73	140	NR	185	NR	70
Lauric Acid	••	140	••	100	••	••
Lauryl Chloride	••	140	••	200	140	••
Lead Acetate	••	140	180	NR	200	160
Lead Chloride.....	••	140	180	140	NR	70
Lead Nitrate.....	••	140	180	200	175	140
Lead Sulfate.....	••	140	180	200	200	140

Acrylonitrile-Butadiene-Styrene Polyvinyl Chloride Type 1 Grade 1 Chlorinated Polyvinyl Chloride Type IV Grade 1
Fluorocarbon Elastomer (Viton ® is a registered trademark of the DuPont Co.) Ethylene Propylene Diene Monomer

** Maximum recommended temperature, for chemical resistance, under normal conditions. § Non-pressure, vent-only, applications when chemical is in gas form.

Chemical Resistance

The following table gives the chemical resistance of ABS, PVC and CPVC thermoplastic piping materials and three commonly used seal materials. The information shown is based upon laboratory tests conducted by the manufacturers of the materials, and it is intended to provide a general guideline on the resistance of these materials to various chemicals. **NOTICE:** This table is not a guarantee, and any piping systems using products made of these materials should be tested under actual service conditions to determine their suitability for a particular purpose. See website for most current data: www.charlottepipe.com

Number = Maximum Recommended Temp. (°F)** CF = Consult Factory NR = Not Recommended •• = Incomplete Data

Chemical Name	Pipe & Fitting Materials Recommended Max. Temp (°F)			Seal Materials Recommended Max. Temp. (°F)		
	ABS	PVC	CPVC	Viton®	EPDM	Neoprene
Lemon Oil	••	••	NR	200	••	100
Ligroine	NR	NR	NR	100	••	70
Lime Sulfur.....	••	140	180	185	200	100
Limonene	••	••	NR	••	••	••
Linoleic Acid.....	••	140	180	140	70	••
Linoleic Oil.....	••	140	180	70	••	••
Linseed Oil	73	140	NR	200	70	70
Linseed Oil, Blue	73	73	NR	200	••	••
Liqueurs.....	NR	140	••	••	••	70
Lithium Bromide (Brine).....	••	140	180	200	••	••
Lithium Chloride	••	140	180	140	100	••
Lithium Sulfate	••	140	180	••	••	••
Lubricating Oil, ASTM #1, #2, #3 ...	NR	140	73	150	NR	70
Lux Liquid.....	••	NR	••	••	••	••
Lye Solutions.....	••	140	180	••	••	••
Machine Oil.....	NR	140	180	••	NR	••
Magnesium Carbonate	120	140	180	200	170	140
Magnesium Chloride	120	140	180	170	170	160
Magnesium Citrate	120	140	180	200	175	••
Magnesium Fluoride	120	••	180	200	140	••
Magnesium Hydroxide	120	140	180	200	200	••
Magnesium Nitrate.....	120	140	180	••	200	••
Magnesium Oxide	120	••	180	••	140	160
Magnesium Salts, Inorganic.....	120	••	180	••	••	••
Magnesium Sulfate.....	120	140	180	200	175	160
Maleic Acid.....	140	140	180	200	NR	70
Maleic Acid (Sat'd)	140	140	180	200	70	NR
Malic Acid	140	140	180	••	••	••
Manganese Sulfate	120	140	180	200	175	160
Mercuric Acid	••	••	180	••	••	••
Mercuric Chloride.....	••	140	140	185	200	140
Mercuric Cyanide	••	140	180	70	70	70
Mercuric Sulfate	••	140	180	70	70	••
Mercurous Nitrate.....	••	140	180	70	70	NR
Mercury.....	••	140	180	185	200	140

Acrylonitrile-Butadiene-Styrene Polyvinyl Chloride Type 1 Grade 1 Chlorinated Polyvinyl Chloride Type IV Grade 1
 Fluorocarbon Elastomer (Viton® is a registered trademark of the DuPont Co.) Ethylene Propylene Diene Monomer
 ** Maximum recommended temperature, for chemical resistance, under normal conditions. § Non-pressure, vent-only, applications when chemical is in gas form.

Chemical Resistance

CAUTION

PVC, ABS and CPVC piping systems have very different chemical resistance. Review manufacturer's literature for all chemicals coming into contact with the piping materials prior to use.

The following table gives the chemical resistance of ABS, PVC and CPVC thermoplastic piping materials and three commonly used seal materials. The information shown is based upon laboratory tests conducted by the manufacturers of the materials, and it is intended to provide a general guideline on the resistance of these materials to various chemicals. **NOTICE:** This table is not a guarantee, and any piping systems using products made of these materials should be tested under actual service conditions to determine their suitability for a particular purpose. See website for most current data: www.charlottepipe.com

Number = Maximum Recommended Temp. (°F)** CF = Consult Factory NR = Not Recommended •• = Incomplete Data

Chemical Name	Pipe & Fitting Materials Recommended Max. Temp (°F)			Seal Materials Recommended Max. Temp. (°F)		
	ABS	PVC	CPVC	Viton ®	EPDM	Neoprene
Methane.....	140§	140§	180§	185	NR	70
Methanol.....	NR	140	NR	NR	140	140
Methoxyethyl Oleate	NR	73	••	••	••	••
Methyl Amine.....	NR	NR	NR	100	70	70
Methyl Bromide.....	NR	NR	NR	185	NR	NR
Methyl Cellosolve	NR	NR	NR	NR	70	70
Methyl Chloride.....	NR	NR	NR	70	NR	NR
Methyl Chloroform	NR	NR	NR	70	NR	NR
Methyl Ethyl Ketone	NR	NR	NR	NR	70	NR
Methyl Formate.....	NR	••	NR	NR	100	70
Methyl Isobutyl Ketone	NR	NR	NR	NR	70	NR
Methyl Methacrylate	NR	NR	NR	NR	NR	NR
Methyl Sulfate.....	NR	73	73	••	••	••
Methyl Sulfuric Acid	••	140	180	••	••	••
Methylene Bromide.....	NR	NR	NR	70	NR	NR
Methylene Chloride.....	NR	NR	NR	73	NR	NR
Methylene Chlorobromide	NR	NR	NR	NR	NR	NR
Methylene Iodine	NR	NR	NR	••	200	••
Methylisobutyl Carbinol	NR	NR	NR	70	70	70
Milk.....	140	140	73	200	200	160
Mineral Oil.....	73	140	73	200	NR	70
Molasses	120	140	180	185	100	150
Monochloroacetic Acid, 50%	73	140	73	70	NR	NR
Monoethanolamine	NR	NR	NR	185	70	NR
Motor Oil	73	140	180	200	NR	••
Muriatic Acid, Up to 30% HCl.....	NR	140	180	••	••	••
Naphtha.....	NR	NR	NR	150	NR	NR
Naphthalene.....	NR	NR	NR	170	NR	NR
n-Heptane	NR	NR	NR	••	••	••
Natural Gas.....	NR	140§	••	185	NR	140
Nickel Acetate.....	73	73	180	NR	70	••
Nickel Chloride.....	73	140	180	200	200	160
Nickel Nitrate	73	140	180	200	180	••
Nickel Sulfate	73	140	180	200	200	160
Nicotine	NR	140	••	••	••	NR

Acrylonitrile-Butadiene-Styrene Polyvinyl Chloride Type 1 Grade 1 Chlorinated Polyvinyl Chloride Type IV Grade 1
Fluorocarbon Elastomer (Viton ® is a registered trademark of the DuPont Co.) Ethylene Propylene Diene Monomer
** Maximum recommended temperature, for chemical resistance, under normal conditions. § Non-pressure, vent-only, applications when chemical is in gas form.

Chemical Resistance

The following table gives the chemical resistance of ABS, PVC and CPVC thermoplastic piping materials and three commonly used seal materials. The information shown is based upon laboratory tests conducted by the manufacturers of the materials, and it is intended to provide a general guideline on the resistance of these materials to various chemicals. **NOTICE:** This table is not a guarantee, and any piping systems using products made of these materials should be tested under actual service conditions to determine their suitability for a particular purpose. See website for most current data: www.charlottepipe.com

Number = Maximum Recommended Temp. (°F)** CF = Consult Factory NR = Not Recommended •• = Incomplete Data

Chemical Name	Pipe & Fitting Materials Recommended Max. Temp (°F)			Seal Materials Recommended Max. Temp. (°F)		
	ABS	PVC	CPVC	Viton®	EPDM	Neoprene
Nicotinic Acid	NR	140	••	••	70	140
Nitric Acid, 10%	73	140	140	185	70	NR
Nitric Acid, 30%	NR	140	120	160	70	NR
Nitric Acid, 40%	NR	NR	120	140	NR	NR
Nitric Acid, 50%	NR	NR	73	120	NR	NR
Nitric Acid, 70%	NR	NR	73	100	NR	NR
Nitric Acid, 100%	NR	NR	NR	••	••	••
Nitric Acid, Fuming	NR	NR	NR	NR	NR	NR
Nitrobenzene	NR	NR	NR	70	NR	••
Nitroglycerine	NR	NR	NR	••	••	••
Nitrous Acid, 10%	NR	73	••	100	••	••
Nitrous Oxide	73§	73§	••	70	••	NR
Nitroglycol	NR	NR	••	••	••	70
Nonionic Surfactants	140	140	NR	200	200	160
1-Octanol	NR	••	NR	••	••	••
Ocenol	NR	••	••	••	••	••
Oils, Vegetable	NR	140	NR	200	NR	••
Oils, Sour Crude	••	••	NR	••	••	••
Oleic Acid	140	140	180	185	70	70
Oleum	NR	NR	NR	NR	NR	NR
Olive Oil	73	140	NR	150	••	140
Oxalic Acid (Sat'd)	••	140	140	100	150	100
Oxalic Acid, 20%	73	140	180	100	150	100
Oxalic Acid, 50%	••	140	73	100	150	100
Oxygen	140§	140§	180§	185	200	140
Ozone	140§	140§	180§	185	200	NR
Ozonized Water	••	••	••	••	••	••
Palm Oil	••	••	••	70	NR	••
Palmitic Acid, 10%	73	140	73	185	70	NR
Palmitic Acid, 70%	NR	NR	73	185	••	NR
Paraffin	73	140	••	200	NR	140
Peanut Oil	••	••	••	150	NR	••
Pentachlorophenol	NR	NR	NR	200	NR	NR
Peppermint Oil	NR	73	73	73	73	73
Peracetic Acid, 40%	NR	NR	NR	••	••	••

Acrylonitrile-Butadiene-Styrene Polyvinyl Chloride Type 1 Grade 1 Chlorinated Polyvinyl Chloride Type IV Grade 1
 Fluorocarbon Elastomer (Viton® is a registered trademark of the DuPont Co.) Ethylene Propylene Diene Monomer
 ** Maximum recommended temperature, for chemical resistance, under normal conditions. § Non-pressure, vent-only, applications when chemical is in gas form.

Chemical Resistance

CAUTION

PVC, ABS and CPVC piping systems have very different chemical resistance. Review manufacturer's literature for all chemicals coming into contact with the piping materials prior to use.

The following table gives the chemical resistance of ABS, PVC and CPVC thermoplastic piping materials and three commonly used seal materials. The information shown is based upon laboratory tests conducted by the manufacturers of the materials, and it is intended to provide a general guideline on the resistance of these materials to various chemicals. **NOTICE:** This table is not a guarantee, and any piping systems using products made of these materials should be tested under actual service conditions to determine their suitability for a particular purpose. See website for most current data: www.charlottepipe.com

PVC, ABS and CPVC piping systems have very different chemical resistance. Review manufacturer's literature for all chemicals coming into contact with the piping materials prior to use.

Number = Maximum Recommended Temp. (°F)** CF = Consult Factory NR = Not Recommended •• = Incomplete Data

Chemical Name	Pipe & Fitting Materials Recommended Max. Temp (°F)			Seal Materials Recommended Max. Temp. (°F)		
	ABS	PVC	CPVC	Viton ®	EPDM	Neoprene
Perchloric Acid, 10%.....	NR	73	73	70	70	70
Perchloric Acid, 70%.....	NR	NR	NR	185	70	NR
Perchloroethylene	NR	NR	NR	200	NR	NR
Perphosphate.....	••	140	170	70	70	••
Petrolatum	••	140	180	••	••	••
Petroleum Oils, Sour.....	••	73	180	200	NR	••
Petroleum Oils, Refined.....	73	140	180	200	NR	••
Phenol.....	NR	NR	NR	200	70	NR
Phenylhydrazine	NR	NR	NR	NR	NR	••
Phenylhydrazine Hydrochloride	NR	NR	NR	••	••	••
Phosgene, Liquid	NR	NR	NR	NR	73	••
Phosgene, Gas	NR	NR	NR	NR	73	••
Phosphoric Acid, 10%	73	140	180	200	140	140
Phosphoric Acid, 50%	73	140	180	200	70	70
Phosphoric Acid, 85%	73	140	180	200	70	NR
Phosphoric Anhydride	••	73	73	••	••	••
Phosphorous Pentoxide	••	73	180	200	200	••
Phosphorous, Red	NR	70	••	••	••	••
Phosphorus Trichloride	NR	NR	NR	••	••	NR
Phosphorous, Yellow	NR	73	••	••	••	••
Photographic Solutions	••	140	180	185	••	100
Phthalic Acid, 10%	73	73	••	140	••	NR
Picric Acid.....	NR	NR	NR	140	140	70
Pine Oil.....	NR	••	NR	70	••	NR
Plating Solutions, Brass.....	••	140	180	70	70	100
Plating Solutions, Cadmium.....	••	140	180	70	70	100
Plating Solutions, Chrome	••	140	180	••	••	R
Plating Solutions, Copper	••	140	180	70	70	R
Plating Solutions, Gold	••	140	180	70	70	125
Plating Solutions, Indium	••	••	••	••	••	••
Plating Solutions, Lead.....	••	140	180	70	70	70
Plating Solutions, Nickel	••	140	180	70	70	••
Plating Solutions, Rhodium.....	••	140	180	70	••	••
Plating Solutions, Silver	••	140	180	70	70	70
Plating Solutions, Tin	••	140	180	140	100	••

Acrylonitrile-Butadiene-Styrene Polyvinyl Chloride Type 1 Grade 1 Chlorinated Polyvinyl Chloride Type IV Grade 1
Fluorocarbon Elastomer (Viton ® is a registered trademark of the DuPont Co.) Ethylene Propylene Diene Monomer
** Maximum recommended temperature, for chemical resistance, under normal conditions. § Non-pressure, vent-only, applications when chemical is in gas form.

Chemical Resistance

The following table gives the chemical resistance of ABS, PVC and CPVC thermoplastic piping materials and three commonly used seal materials. The information shown is based upon laboratory tests conducted by the manufacturers of the materials, and it is intended to provide a general guideline on the resistance of these materials to various chemicals. **NOTICE:** This table is not a guarantee, and any piping systems using products made of these materials should be tested under actual service conditions to determine their suitability for a particular purpose. See website for most current data: www.charlottepipe.com

Number = Maximum Recommended Temp. (°F)** CF = Consult Factory NR = Not Recommended •• = Incomplete Data

Chemical Name	Pipe & Fitting Materials Recommended Max. Temp (°F)			Seal Materials Recommended Max. Temp. (°F)		
	ABS	PVC	CPVC	Viton ®	EPDM	Neoprene
Plating Solutions, Zinc	••	140	180	70	70	••
POE Oil (Polyolester).....	••	••	••	••	••	••
Polyethylene Glycol.....	••	••	NR	••	••	••
Polypropylene Glycol.....	••	••	NR	••	••	••
Potash.....	140	140	180	200	170	160
Potassium Acetate	••	••	180	••	••	••
Potassium Alum	••	140	180	200	200	160
Potassium Aluminum Sulfate	••	140	180	200	200	160
Potassium Amyl Xanthate	••	73	••	••	••	••
Potassium Bicarbonate	140	140	180	200	170	160
Potassium Bichromate	140	140	180	200	170	••
Potassium Bisulfate	••	••	••	200	170	140
Potassium Borate	140	140	180	200	200	••
Potassium Bromate.....	140	140	180	200	••	140
Potassium Bromide.....	140	140	180	200	170	160
Potassium Carbonate	140	140	180	200	170	160
Potassium Chlorate.....	140	140	180	140	140	100
Potassium Chloride	140	140	180	200	200	160
Potassium Chromate.....	140	140	180	200	170	70
Potassium Cyanide.....	140	140	180	185	140	160
Potassium Dichromate	140	140	180	200	170	••
Potassium Ethyl Xanthate.....	••	73	••	••	••	••
Potassium Ferricyanide.....	140	140	180	140	140	150
Potassium Ferrocyanide	140	140	180	140	140	150
Potassium Fluoride	140	140	180	200	140	••
Potassium Hydroxide	140	140	CF	NR	140	160
Potassium Hydroxide, 50%	140	140	CF	NR	140	160
Potassium Hypochlorite	••	73	180	70	NR	••
Potassium Iodide	••	73	180	180	140	160
Potassium Nitrate.....	140	140	180	200	200	140
Potassium Perborate.....	140	140	180	••	••	70
Potassium Perchlorate, (Sat'd).....	140	140	180	150	140	••
Potassium Permanganate, 10%.....	140	140	180	140	200	100
Potassium Permanganate, 25%.....	140	NR	180	140	140	100
Potassium Persulphate, (Sat'd).....	73	140	180	200	200	140

Acrylonitrile-Butadiene-Styrene Polyvinyl Chloride Type 1 Grade 1 Chlorinated Polyvinyl Chloride Type IV Grade 1
 Fluorocarbon Elastomer (Viton ® is a registered trademark of the DuPont Co.) Ethylene Propylene Diene Monomer
 ** Maximum recommended temperature, for chemical resistance, under normal conditions. § Non-pressure, vent-only, applications when chemical is in gas form.

Chemical Resistance

CAUTION

PVC, ABS and CPVC piping systems have very different chemical resistance. Review manufacturer's literature for all chemicals coming into contact with the piping materials prior to use.

The following table gives the chemical resistance of ABS, PVC and CPVC thermoplastic piping materials and three commonly used seal materials. The information shown is based upon laboratory tests conducted by the manufacturers of the materials, and it is intended to provide a general guideline on the resistance of these materials to various chemicals. **NOTICE:** This table is not a guarantee, and any piping systems using products made of these materials should be tested under actual service conditions to determine their suitability for a particular purpose. See website for most current data: www.charlottepipe.com

PVC, ABS and CPVC piping systems have very different chemical resistance. Review manufacturer's literature for all chemicals coming into contact with the piping materials prior to use.

Number = Maximum Recommended Temp. (°F)** CF = Consult Factory NR = Not Recommended •• = Incomplete Data

Chemical Name	Pipe & Fitting Materials Recommended Max. Temp (°F)			Seal Materials Recommended Max. Temp. (°F)		
	ABS	PVC	CPVC	Viton ®	EPDM	Neoprene
Potassium Phosphate	73	••	180	••	••	••
Potassium Sulfate.....	73	140	180	200	200	140
Potassium Sulfite.....	73	140	180	200	200	140
Potassium Tripolyphosphate	••	••	180	100	••	70
Propane	140§	140§	73§	70	NR	70
Propanol, Up to 0.5%.....	NR	••	180	••	••	••
Propanol, Over 0.5%	NR	••	NR	••	••	••
Propargyl Alcohol.....	NR	140	NR	140	140	NR
Propionic Acid, Up to 2%	NR	••	180	••	••	NR
Propionic Acid, Over 2%.....	NR	••	NR	••	••	NR
Propyl Alcohol.....	NR	140	NR	••	140	140
Propylene Dichloride.....	NR	NR	NR	70	NR	NR
Propylene Glycol, Up to 25%	73	140	180	140	70	100
Propylene Glycol, Up to 50%	73	140	NR	140	70	100
Propylene Oxide.....	NR	NR	NR	NR	70	NR
Pyridine	NR	NR	NR	NR	70	NR
Pyrogallia Acid	••	73	••	••	••	70
Quaternary Ammonium Salts	••	••	NR	••	••	••
Rayon Coagulating Bath	••	140	NR	••	••	••
Reverse Osmosis Water	140	140	180	200	200	160
Salicylic Acid.....	••	140	180	185	200	NR
Sea Water	140	140	180	••	••	••
Selenic Acid	••	140	••	••	••	70
Silicic Acid.....	••	140	••	200	140	140
Silicone Oil.....	••	73	150	185	140	70
Silver Chloride	140	••	180	••	••	••
Silver Cyanide	140	140	180	140	140	70
Silver Nitrate	140	140	180	200	200	160
Silver Sulfate	140	140	180	200	170	••
Soaps.....	140	140	180	200	200	140
Sodium Acetate	120	140	180	NR	170	••
Sodium Aluminate	120	••	180	200	200	140
Sodium Alum	120	140	180	200	170	140
Sodium Arsenate	120	140	180	200	140	70
Sodium Benzoate.....	120	140	180	200	200	••

Acrylonitrile-Butadiene-Styrene Polyvinyl Chloride Type 1 Grade 1 Chlorinated Polyvinyl Chloride Type IV Grade 1
Fluorocarbon Elastomer (Viton ® is a registered trademark of the DuPont Co.) Ethylene Propylene Diene Monomer
** Maximum recommended temperature, for chemical resistance, under normal conditions. § Non-pressure, vent-only, applications when chemical is in gas form.

Chemical Resistance

The following table gives the chemical resistance of ABS, PVC and CPVC thermoplastic piping materials and three commonly used seal materials. The information shown is based upon laboratory tests conducted by the manufacturers of the materials, and it is intended to provide a general guideline on the resistance of these materials to various chemicals. **NOTICE:** This table is not a guarantee, and any piping systems using products made of these materials should be tested under actual service conditions to determine their suitability for a particular purpose. See website for most current data: www.charlottepipe.com

Number = Maximum Recommended Temp. (°F)** CF = Consult Factory NR = Not Recommended • • = Incomplete Data

Chemical Name	Pipe & Fitting Materials Recommended Max. Temp (°F)			Seal Materials Recommended Max. Temp. (°F)		
	ABS	PVC	CPVC	Viton®	EPDM	Neoprene
Sodium Bicarbonate	120	140	180	200	200	160
Sodium Bichromate	120	140	180	200	140	70
Sodium Bisulfate	120	140	180	200	200	140
Sodium Bisulfite	120	140	180	200	200	140
Sodium Borate	120	73	180	140	140	100
Sodium Bromide	120	140	180	200	200	70
Sodium Carbonate	120	140	180	200	140	140
Sodium Chlorate	120	73	180	100	140	140
Sodium Chloride	120	140	180	200	140	160
Sodium Chlorite	120	NR	180	NR	NR	• •
Sodium Chromate	120	• •	180	70	70	70
Sodium Cyanide	120	73	180	140	140	140
Sodium Dichromate	120	140	180	200	140	NR
Sodium Ferricyanide	120	140	180	140	140	• •
Sodium Ferrocyanide	120	140	180	140	140	• •
Sodium Fluoride	120	73	140	140	140	70
Sodium Formate	• •	• •	180	• •	• •	• •
Sodium Hydroxide, 15%	120	140	CF	NR	180	160
Sodium Hydroxide, 30%	73	73	CF	NR	140	160
Sodium Hydroxide, 50%	73	73	CF	NR	140	160
Sodium Hydroxide, 70%	NR	73	CF	NR	140	160
Sodium Hypobromite	• •	• •	180	• •	• •	• •
Sodium Hypochlorite, 15%	73	73†	180†	185	70	NR
Sodium Hypochlorite (Sat'd)	NR	73†	180†	140	NR	NR
Sodium Iodide	• •	• •	180	• •	• •	160
Sodium Metaphosphate	120	73	180	70	70	• •
Sodium Nitrate	120	140	180	200	200	140
Sodium Nitrite	120	140	180	200	170	140
Sodium Palmitate Solution, 5%	120	140	180	• •	• •	• •
Sodium Perborate	120	140	180	70	70	70
Sodium Perchlorate	120	140	180	• •	• •	• •
Sodium Peroxide	• •	140	• •	185	140	70
Sodium Phosphate, Alkaline	73	140	180	200	170	140
Sodium Phosphate, Acid	73	140	180	200	170	140
Sodium Phosphate, Neutral	73	140	180	200	170	140

Acrylonitrile-Butadiene-Styrene Polyvinyl Chloride Type 1 Grade 1 Chlorinated Polyvinyl Chloride Type IV Grade 1

Fluorocarbon Elastomer (Viton® is a registered trademark of the DuPont Co.) Ethylene Propylene Diene Monomer

** Maximum recommended temperature, for chemical resistance, under normal conditions. § Non-pressure, vent-only, applications when chemical is in gas form.

† Must use sodium hypochlorite resistant cement for making joints.

Chemical Resistance

CAUTION

PVC, ABS and CPVC piping systems have very different chemical resistance. Review manufacturer's literature for all chemicals coming into contact with the piping materials prior to use.

The following table gives the chemical resistance of ABS, PVC and CPVC thermoplastic piping materials and three commonly used seal materials. The information shown is based upon laboratory tests conducted by the manufacturers of the materials, and it is intended to provide a general guideline on the resistance of these materials to various chemicals. **NOTICE:** This table is not a guarantee, and any piping systems using products made of these materials should be tested under actual service conditions to determine their suitability for a particular purpose. See website for most current data: www.charlottepipe.com

Number = Maximum Recommended Temp. (°F)** CF = Consult Factory NR = Not Recommended •• = Incomplete Data

Chemical Name	Pipe & Fitting Materials Recommended Max. Temp (°F)			Seal Materials Recommended Max. Temp. (°F)		
	ABS	PVC	CPVC	Viton ®	EPDM	Neoprene
Sodium Silicate.....	••	••	180	200	200	140
Sodium Sulfate.....	73	140	180	200	140	140
Sodium Sulfide.....	73	140	180	200	140	140
Sodium Sulfite.....	73	140	180	200	140	140
Sodium Thiosulfate.....	73	140	180	200	200	160
Sodium Tripolyphosphate.....	••	••	180	••	••	••
Solcylaldehyde.....	NR	NR	••	••	••	••
Sour Crude Oil.....	NR	140	••	200	NR	NR
Soybean Oil.....	••	••	NR	200	NR	70
Stannic Chloride.....	120	140	180	200	100	NR
Stannous Chloride.....	120	140	180	200	70	160
Stannous Sulfate.....	••	••	180	••	••	••
Starch.....	140	140	180	200	170	160
Stearic Acid.....	••	140	73	100	NR	70
Stoddard's Solvent.....	NR	NR	NR	185	NR	NR
Strontium Chloride.....	••	••	180	••	••	••
Styrene.....	NR	••	NR	100	NR	NR
Succinic Acid.....	••	140	••	70	70	••
Sugar.....	120	••	180	200	140	140
Sulfamic Acid.....	NR	NR	180	NR	NR	70
Sulfate Liquors.....	••	••	••	70	70	••
Sulfite Liquor.....	••	••	180	140	140	70
Sulfur.....	••	140	73	200	••	70
Sulfur Chloride.....	••	••	••	70	NR	NR
Sulfur Dioxide, Dry.....	73§	140§	NR	100	70	NR
Sulfur Dioxide, Wet.....	73§	73§	NR	140	140	••
Sulfur Trioxide.....	••	140	180	140	70	NR
Sulfur Trioxide, Gas.....	140§	140§	••	140	70	NR
Sulfuric Acid, 10%.....	120	140	180	200	140	100
Sulfuric Acid, 20%.....	120	140	180	200	140	100
Sulfuric Acid, 30%.....	NR	140	180	200	140	100
Sulfuric Acid, 50%.....	NR	140	180	200	70	NR
Sulfuric Acid, 60%.....	NR	140	180	200	NR	NR
Sulfuric Acid, 70%.....	NR	140	180	200	NR	NR
Sulfuric Acid, 80%.....	NR	73	180	180	NR	NR

Acrylonitrile-Butadiene-Styrene Polyvinyl Chloride Type 1 Grade 1 Chlorinated Polyvinyl Chloride Type IV Grade 1
Fluorocarbon Elastomer (Viton ® is a registered trademark of the DuPont Co.) Ethylene Propylene Diene Monomer
** Maximum recommended temperature, for chemical resistance, under normal conditions. § Non-pressure, vent-only, applications when chemical is in gas form.

Chemical Resistance

The following table gives the chemical resistance of ABS, PVC and CPVC thermoplastic piping materials and three commonly used seal materials. The information shown is based upon laboratory tests conducted by the manufacturers of the materials, and it is intended to provide a general guideline on the resistance of these materials to various chemicals. **NOTICE:** This table is not a guarantee, and any piping systems using products made of these materials should be tested under actual service conditions to determine their suitability for a particular purpose. See website for most current data: www.charlottepipe.com

Number = Maximum Recommended Temp. (°F)** CF = Consult Factory NR = Not Recommended •• = Incomplete Data

Chemical Name	Pipe & Fitting Materials Recommended Max. Temp (°F)			Seal Materials Recommended Max. Temp. (°F)		
	ABS	PVC	CPVC	Viton ®	EPDM	Neoprene
Sulfuric Acid, 90%.....	NR	73	73	160	NR	NR
Sulfuric Acid, 94%.....	NR	NR	73	160	NR	NR
Sulfuric Acid, 98%.....	NR	NR	73	160	NR	NR
Sulfuric Acid, 100%.....	NR	••	NR	160	NR	NR
Sulfurous Acid.....	NR	NR	180	100	75	NR
Surfactants, Nonionic.....	140	140	NR	200	200	160
Tall Oil.....	••	140	180	70	NR	70
Tannic Acid, 10%.....	NR	140	180	100	70	100
Tannic Acid, 30%.....	NR	••	73	••	••	••
Tanning Liquors.....	140	140	180	200	••	70
Tar.....	NR	NR	NR	185	NR	70
Tartaric Acid.....	140	140	73	70	NR	70
Terpenes.....	NR	••	NR	••	••	••
Tetrachloroethylene.....	NR	NR	NR	200	NR	NR
Tetraethyl Lead.....	NR	73	••	70	NR	••
Tetrahydrodurane.....	NR	NR	NR	••	••	••
Tetrahydrofuran.....	NR	NR	NR	NR	NR	NR
Tetralin.....	NR	NR	NR	NR	NR	NR
Tetra Sodium Pyrophosphate.....	••	140	180	••	••	••
Texanol.....	••	••	NR	••	••	••
Thionyl Chloride.....	NR	NR	NR	••	••	NR
Thread Cutting Oils.....	73	73	••	70	NR	••
Titanium Tetrachloride.....	NR	NR	NR	185	NR	NR
Toluene, Toluol.....	NR	NR	NR	70	NR	NR
Toluene-Kerosene, 25%-75%.....	NR	NR	NR	••	••	••
Tomato Juice.....	73	73	73	200	200	70
Toxaphene-Xylene, 90%-100%.....	NR	NR	NR	••	••	••
Transformer Oil.....	NR	140	••	140	140	NR
Transformer Oil, DTE/30.....	NR	••	••	••	NR	NR
Tribute.....	••	••	NR	••	••	••
Tributyl Phosphate.....	NR	NR	NR	NR	70	NR
Tributyl Citrate.....	NR	73	••	••	••	••
Trichloroacetic Acid.....	NR	140	••	NR	70	70
Trichloroethane.....	NR	NR	NR	••	••	••
Trichloroethylene.....	NR	NR	NR	185	NR	NR

Acrylonitrile-Butadiene-Styrene Polyvinyl Chloride Type 1 Grade 1 Chlorinated Polyvinyl Chloride Type IV Grade 1
Fluorocarbon Elastomer (Viton ® is a registered trademark of the DuPont Co.) Ethylene Propylene Diene Monomer

** Maximum recommended temperature, for chemical resistance, under normal conditions. § Non-pressure, vent-only, applications when chemical is in gas form.

Chemical Resistance

CAUTION

PVC, ABS and CPVC piping systems have very different chemical resistance. Review manufacturer's literature for all chemicals coming into contact with the piping materials prior to use.

The following table gives the chemical resistance of ABS, PVC and CPVC thermoplastic piping materials and three commonly used seal materials. The information shown is based upon laboratory tests conducted by the manufacturers of the materials, and it is intended to provide a general guideline on the resistance of these materials to various chemicals. **NOTICE:** This table is not a guarantee, and any piping systems using products made of these materials should be tested under actual service conditions to determine their suitability for a particular purpose. See website for most current data: www.charlottepipe.com

Number = Maximum Recommended Temp. (°F)** CF = Consult Factory NR = Not Recommended •• = Incomplete Data

Chemical Name	Pipe & Fitting Materials Recommended Max. Temp (°F)			Seal Materials Recommended Max. Temp. (°F)		
	ABS	PVC	CPVC	Viton ®	EPDM	Neoprene
Triethanolamine.....	NR	73	NR	NR	70	70
Triethylamine	NR	140	••	200	••	70
Trimethylpropane.....	NR	73	••	••	180	160
Trisodium Phosphate.....	73	140	180	185	70	70
Turpentine	NR	140	NR	150	NR	NR
Urea	73	140	180	185	200	140
Urine	140	140	180	70	200	140
Vaseline	NR	NR	NR	70	NR	140
Vegetable Oil.....	NR	140	NR	200	NR	70
Vinegar.....	73	140	180	NR	180	70
Vinegar, White	73	140	180	200	200	••
Vinyl Acetate	NR	NR	NR	NR	70	NR
Water	140	140	180	200	200	160
Water, Acid Mine	140	140	180	••	200	160
Water, Deionized	NR	140	180	••	200	160
Water, Demineralized	NR	140	180	200	200	160
Water, Distilled	NR	140	180	••	200	160
Water, Potable.....	NR	140	180	••	200	160
Water, Salt.....	140	140	180	••	200	160
Water, Sea	140	140	180	••	200	160
Water, Sewage	140	140	180	••	200	••
Water, Swimming Pool	NR	73	180	••	••	••
WD 40	NR	••	NR	••	••	••
Whiskey	NR	140	180	140	200	140
White Liquor.....	73	140	180	••	••	140
Wines.....	NR	140	180	140	170	140
Xylene.....	NR	NR	NR	150	NR	NR
Zinc Acetate.....	••	140	180	70	180	160
Zinc Bromide	••	140	180	••	••	••
Zinc Carbonate.....	120	••	180	••	••	••
Zinc Chloride.....	120	140	180	200	180	160
Zinc Nitrate	120	140	180	200	180	••
Zinc Phosphate.....	••	••	180	••	••	••
Zinc Sulfate	••	140	180	200	180	140

Acrylonitrile-Butadiene-Styrene Polyvinyl Chloride Type 1 Grade 1 Chlorinated Polyvinyl Chloride Type IV Grade 1
 Fluorocarbon Elastomer (Viton ® is a registered trademark of the DuPont Co.) Ethylene Propylene Diene Monomer
 ** Maximum recommended temperature, for chemical resistance, under normal conditions. § Non-pressure, vent-only, applications when chemical is in gas form.

Reference Standards Plastics

ASTM TITLE

- ASTM D 635** Standard Test Method for Rate of Burning and/or Extent and Time of Burning of Plastics in a Horizontal Position
SCOPE: This fire-test-response test method covers a small-scale laboratory screening procedure for comparing the relative linear rate of burning or extent and time of burning, or both, of plastics in the horizontal position.
- ASTM D 1784** Specification for Rigid Poly (Vinyl Chloride) (PVC) Compounds and Chlorinated Poly (Vinyl Chloride) (CPVC) Compounds
SCOPE: This specification covers rigid PVC and CPVC compounds intended for general purpose use in extruded or molded form.
- ASTM D 1785** Specification for Poly (Vinyl Chloride) (PVC) Plastic Pipe, Schedule 40, 80, and 120
SCOPE: This specification covers PVC pipe in Schedule 40, 80, and 120 for pressure applications. This system is intended for pressure applications where the operating temperature will not exceed 140 degrees fahrenheit.
- ASTM D 2235** Specification for Solvent Cement for Acrylonitrile-Butadiene-Styrene (ABS) Plastic Pipe and Fittings
SCOPE: This specification covers solvent cement for joining (ABS) pipe and fittings for non-pressure systems.
- ASTM D 2241** Specifications for Poly (Vinyl Chloride) (PVC) Pipe Pressure-Rated (SDR-Series)
SCOPE: This specification covers (PVC) pipe made in standard thermoplastic pipe dimension ratios (SDR Series) and Pressure Rated for Water.
- ASTM D 2321** Standard Practice for Underground Installation of Thermoplastic Pipe for Sewers and Other Gravity-Flow Applications
SCOPE: This practice provides recommendations for the installation of buried thermoplastic pipe used in sewers and other gravity-flow applications (non-pressure applications).
- ASTM D 2464** Specifications for Threaded Poly (Vinyl Chloride) (PVC) Plastic Pipe Fittings, Schedule 80
SCOPE: This specification covers (PVC) threaded schedule 80 fittings which are used with the distribution of pressurized liquids only. CPVC threaded Schedule 80 fittings are now covered by ASTM F 437.
- ASTM D 2466** Specifications for Poly (Vinyl Chloride) (PVC) Plastic Pipe Fittings, Schedule 40
SCOPE: This specification covers (PVC) Schedule 40 fittings used for distribution of pressurized liquids only.
- ASTM D 2564** Specifications for Solvent Cements for Poly (Vinyl Chloride) (PVC) Plastic Pipe and Fittings
SCOPE: This specification covers requirements for (PVC) solvent cements to be used in joining (PVC) piping systems.
- ASTM D 2661** Specifications for Acrylonitrile-Butadiene-Styrene (ABS) Schedule 40 Plastic Drain, Waste, and Vent Pipe and Fittings
SCOPE: This specification covers fittings and single extruded (solid wall) (ABS) plastic drain, waste, and vent pipe made to Schedule 40 iron pipe sizes.
- ASTM D 2665** Specifications for Poly (Vinyl Chloride) (PVC) Plastic Drain, Waste, and Vent Pipe and Fittings
SCOPE: This specification covers requirements for (PVC) plastic drain, waste, and vent pipe and fittings suitable for the drainage and venting of sewage and certain other liquid waste.

Reference Standards Plastics

ASTM TITLE

- ASTM D 2729** Specifications for Poly (Vinyl Chloride) (PVC) Sewer Pipe and Fittings "Sewer and Drain"
SCOPE: This specification covers requirements for (PVC) sewer pipe and fittings. The pipe and fittings in this specification are designed for sewer and drainage applications outside the building.
- ASTM D 2846** Specifications for Chlorinated Poly (Vinyl Chloride) (CPVC) Plastic Hot and Cold Water Distribution System
SCOPE: This specification covers requirements for (CPVC) plastic hot and cold water distribution system components made in one standard dimension ratio and intended for water service up to and including 180 degrees fahrenheit.
- ASTM D 2949** Specifications for 3.25-in. Outside Diameter Poly (Vinyl Chloride) (PVC) Plastic Drain, Waste, and Vent Pipe and Fittings
SCOPE: The requirements of this specification are intended to provide pipe and fittings suitable for drainage of sewage and certain other liquid waste.
- ASTM D 3034** Specifications for Type PMS Poly (Vinyl Chloride) (PVC) Sewer Pipe and Fittings SDR 35
SCOPE: The requirements of this specification are intended to provide pipe and fittings suitable for non-pressure drainage of sewage and other surface water.
- ASTM D 3212** Specifications for Joints for Drain and Sewer Plastic Pipes Using Flexible Elastomeric Seals
SCOPE: This specification covers joints for plastic pipe systems through compression of an elastomeric seal or ring.
- ASTM D 3311** Specification for Drain, Waste and Vent (DWV) Plastic Fitting Patterns
SCOPE: This specification provides standard fitting geometries and laying lengths for plastic fittings intended for use in drain, waste, and vent applications.
- ASTM D 3965** Specifications for Rigid Acrylonitrile-Butadiene-Styrene (ABS) Material for Pipe and Fittings
SCOPE: This specification covers materials made from only virgin ABS polymers and blends of ABS polymers suitable for use in the extrusion of pipe and molded fittings.
- ASTM D 4396** Specifications for Rigid Poly (Vinyl Chloride) (PVC) and Related Plastic Compounds for Non-pressure Piping Products
SCOPE: The requirements of this specification are intended for the quality control of compounds used to manufacture pipe and fittings intended for non-pressure use.
- ASTM F 437** Specification for Threaded Chlorinated Poly (Vinyl Chloride) (CPVC) Plastic Pipe Fitting, Schedule 80
SCOPE: This specification covers CPVC threaded Schedule 80 fittings, intended for use with iron pipe size (IPS) outside diameter plastic pipe.
- ASTM F 439** Specification for Chlorinated Poly (Vinyl Chloride) (CPVC) Plastic Pipe Fitting, Schedule 80
SCOPE: This specification covers Schedule 80 CPVC fittings, intended for use with iron pipe size (IPS) outside diameter plastic pipe.
- ASTM F 441** Specifications for Chlorinated Poly (Vinyl Chloride) (CPVC) Plastic Pipe, Schedule 40 and Schedule 80
SCOPE: This specification covers CPVC pipe made in Schedule 80 sizes and pressure rated for water.

Reference Standards Plastics

ASTM TITLE

- ASTM F 477** Specifications for Elastomeric Seals (Gaskets) for Joining Plastic Pipe
SCOPE: This specification covers elastomeric seals (gaskets) used to seal the joint of plastic pipe used for gravity application.
- ASTM F 480** Specification for Thermoplastic Well Casing Pipe and Couplings Made in Standard Dimension Ratios (SDR), Schedule 40 and Schedule 80
SCOPE: This specification covers water well casing pipe and couplings made from thermoplastic material in Standard Dimension Ratios (SDR), Schedule 40 and Schedule 80.
- ASTM F 493** Specification for Solvent Cements for Chlorinated Poly (Vinyl Chloride) (CPVC) Plastic Pipe and Fittings
SCOPE: This specification provides requirements for CPVC solvent cement to be used in joining CPVC pipe and socket-type fittings.
- ASTM F 628** Specification for Acrylonitrile-Butadiene-Styrene (ABS) Schedule 40 Plastic Drain, Waste, and Vent Pipe with a Cellular Core
SCOPE: This specification covers coextruded ABS plastic drain, waste, and vent pipe made to Schedule 40 iron pipe size (IPS).
- ASTM F 656** Specification for Primers for Use in Solvent Cement Joints of Poly (Vinyl Chloride) (PVC) Plastic Pipe and Fittings
SCOPE: This specification covers requirements for primers for use with PVC pipe and fittings that are to be joined by PVC cement meeting the requirements of Specification D 2564.
- ASTM F 891** Specification for Coextruded Poly (Vinyl Chloride) (PVC) Plastic Pipe with a Cellular Core Non-pressure in Three Series: Schedule 40, PS Series 25, 50, 100, and a Sewer and Drain Series
SCOPE: This specification covers coextruded PVC plastic pipe with a cellular core for non-pressure use in three series: an IPS Schedule 40 Series; a PS Series with an iron pipe size outside diameter with varying wall thickness as required for pipe stiffness of 25, 50 and 100; and a Sewer and Drain Series.
- ASTM F 1668** Standard Guide for Construction Procedures for Buried Plastic Pipe
SCOPE: This guide describes installation techniques and considerations for open-cut construction of buried pipe.
- ASTM F 1760** Specification for Coextruded Poly (Vinyl Chloride) (PVC) Non-Pressure Plastic Pipe Having Reprocessed-Recycled Content
SCOPE: This specification covers coextruded poly (vinyl chloride) (PVC) plastic pipe with a center layer and concentric inner and outer solid layers. The inner and outer layers are made of virgin PVC compound and the center layer has reprocessed-recycled PVC content.
- ASTM F 1866** Specification for Poly (Vinyl Chloride) (PVC) Plastic Schedule 40 Drainage and DWV Fabricated Fittings
SCOPE: This specification covers requirements and test methods for fabricated poly (vinyl chloride) (PVC) plastic Schedule 40 drainage and DWV fittings to be used with piping manufactured in accordance with specification D 2665, D 1785 or F 891. These fabricated fittings are manufactured from pipe or from a combination of pipe and injection-molded parts.

Reference Standards Plastics

NSF INTERNATIONAL

NSF / ANSI TITLE

- NSF 14** Plastics Piping System Components and Related Materials
SCOPE: This standard establishes minimum physical, performance, health effects, quality assurance, marking and record-keeping requirements for plastic piping components and related materials. The established physical, performance and health effects requirements apply to materials (resin or blended compounds) and ingredients used to manufacture plastic piping system components.
- NSF 61** Drinking Water System Components - Health Effects
SCOPE: This standard covers specific materials or products that come into contact with drinking water, drinking water treatment chemicals or both. The focus of the standard is evaluation of contaminants or impurities imparted indirectly to drinking water.

UNDERWRITERS LABORATORIES

UL TITLE

- UL 94** Flammability Testing
SCOPE: This test indicates that the material was tested in a vertical position and self-extinguished within a specified time after the ignition source was removed.

Temperature Conversion

Degrees Fahrenheit	Degrees Centigrade	Degrees Fahrenheit	Degrees Centigrade
-10	-23.3	90	32.2
-5	-20.6	95	35.0
0	-17.8	100	37.8
5	-15.0	110	43.3
10	-12.2	120	48.9
15	-9.4	130	54.4
20	-6.7	140	60.0
25	-3.9	150	65.6
32	0	160	71.1
35	1.7	170	76.7
40	4.4	180	82.2
45	7.2	190	87.8
50	10.0	200	93.3
55	12.8	212	100.0
60	15.6	220	104.4
65	18.3	230	110.0
70	21.1	240	115.6
75	23.9	250	121.1
80	26.7	260	126.7
85	29.4		

For temperatures not shown, the following formulas apply:

$$^{\circ}\text{F to }^{\circ}\text{C} = (^{\circ}\text{F} - 32) / 1.8 \quad ^{\circ}\text{C to }^{\circ}\text{F} = (^{\circ}\text{C} \times 1.8) + 32$$

Metric Conversion

Pipe Size (mm)	Pipe Size (in.)	Pipe Size (mm)	Pipe Size (in.)
6mm	¼ in.	90mm	3½ in.
7mm	⅜ in.	100mm	4 in.
8mm	¼ in.	125mm	5 in.
10mm	⅜ in.	150mm	6 in.
15mm	½ in.	200mm	8 in.
18mm	⅝ in.	250mm	10 in.
20mm	¾ in.	300mm	12 in.
25mm	1 in.	350mm	14 in.
32mm	1¼ in.	400mm	16 in.
40mm	1½ in.	450mm	18 in.
50mm	2 in.	500mm	20 in.
65mm	2½ in.	600mm	24 in.
80mm	3 in.		

The Conversion of Fractions to Decimals

Fraction	Decimal	Fraction	Decimal
$\frac{1}{64}$	0.015625	$\frac{33}{64}$	0.515625
$\frac{1}{32}$	0.031250	$\frac{17}{32}$	0.53125
$\frac{3}{64}$	0.046875	$\frac{35}{64}$	0.546875
$\frac{1}{16}$	0.062500	$\frac{9}{16}$	0.5625
$\frac{5}{64}$	0.078125	$\frac{37}{64}$	0.578125
$\frac{3}{32}$	0.937500	$\frac{19}{32}$	0.59375
$\frac{7}{64}$	0.109375	$\frac{38}{64}$	0.609375
$\frac{1}{8}$	0.125000	$\frac{5}{8}$	0.625
$\frac{9}{64}$	0.140625	$\frac{41}{64}$	0.640625
$\frac{5}{32}$	0.156250	$\frac{21}{32}$	0.65625
$\frac{11}{64}$	0.171900	$\frac{43}{64}$	0.67187
$\frac{3}{16}$	0.187500	$\frac{11}{16}$	0.6875
$\frac{13}{64}$	0.203100	$\frac{45}{64}$	0.70312
$\frac{7}{32}$	0.218800	$\frac{23}{32}$	0.71875
$\frac{15}{64}$	0.234375	$\frac{47}{64}$	0.734375
$\frac{1}{4}$	0.250000	$\frac{3}{4}$	0.75
$\frac{17}{64}$	0.265625	$\frac{49}{64}$	0.765625
$\frac{9}{32}$	0.281250	$\frac{25}{32}$	0.78125
$\frac{19}{64}$	0.296875	$\frac{51}{64}$	0.79875
$\frac{5}{16}$	0.312500	$\frac{13}{16}$	0.8125
$\frac{21}{64}$	0.328125	$\frac{53}{64}$	0.82125
$\frac{11}{32}$	0.343750	$\frac{27}{32}$	0.84375
$\frac{23}{64}$	0.359375	$\frac{55}{64}$	0.859375
$\frac{3}{8}$	0.375000	$\frac{7}{8}$	0.875
$\frac{25}{64}$	0.398625	$\frac{57}{64}$	0.890625
$\frac{13}{32}$	0.406250	$\frac{29}{32}$	0.90625
$\frac{27}{64}$	0.421875	$\frac{59}{64}$	0.921875
$\frac{7}{16}$	0.437500	$\frac{15}{16}$	0.9375
$\frac{29}{64}$	0.453125	$\frac{61}{64}$	0.953125
$\frac{15}{32}$	0.468750	$\frac{31}{32}$	0.96875
$\frac{31}{64}$	0.484375	$\frac{63}{64}$	0.984375
$\frac{1}{2}$	0.500000	1"	1

Installation Procedures for ABS, PVC and CPVC Piping Systems

With our reliable ABS, PVC and CPVC TrueFit systems, Charlotte Pipe and Foundry is doing more than any other supplier to help contractors work more efficiently and productively.

The following information contains suggested installation and testing procedures. These instructions, however, do not encompass all of the requirements for the design or installation of a piping system.

- Systems should be installed in a good and workmanlike manner consistent with normal industry standards and in conformance with all applicable plumbing, fire and building code requirements.
- Pipe and fitting systems should be used for their intended purpose as defined by local plumbing and building codes and the applicable ASTM standard.
- Follow manufacturers' instructions for all products.

WARNING

Failure to follow **safety precautions** may result in misapplication or improper installation and testing which can cause severe personal injury and / or property damage.

WARNING

Do not use for SPUD GUNS, FLAMETHROWERS, or COMPRESSED AIR GUNS. May result in property damage, injury or death. Use only for fluid handling / plumbing applications.

NOTICE

- Using an external heat source to bend PVC, CPVC, or ABS may result in structural damage to pipe and fittings.
- Always make changes in direction with fittings.

Joining ABS, PVC and CPVC Pipe and Fitting Systems

The tools, cleaner, primer, solvent cement and techniques required to properly join plastic piping systems are dependant

upon application, pipe diameter and weather conditions. Charlotte Pipe and Foundry recommends that installers be trained and pass the ASME B 31.3 Bonder Qualification Test.

Please see the Special Considerations section of this manual for additional information.

This installation manual provides direction for the installation of the following piping systems:

- ½" – 2" FlowGuard Gold® and ReUze® CTS CPVC pipe and fitting systems with one step solvent cement.
- ½" – 4" Iron Pipe Size ABS, PVC and CPVC pipe and fitting systems with two step solvent cement.
- 6" Iron Pipe Size and larger ABS, PVC and CPVC pipe and fitting systems with two step solvent cement.

FlowGuard Gold® and ReUze® CTS CPVC Pipe and Fittings Systems

1. Cut Pipe

- Cut pipe square with the axis. All joints are sealed at the base of the fitting hub. An angled cut may result in joint failure.
- Acceptable tools include ratchet type pipe cutter, miter saw or wheel type pipe cutter. Wheel type pipe cutters must employ a blade designed to cut plastic pipe. Ratchet cutters should be sharpened regularly.
- If any indication of damage or cracking is evident at the tube end, cut off at least 2" of pipe beyond any visible cracks.



2. Remove Burrs and Bevel

- Remove all pipe burrs from inside and outside diameter of pipe with a knife edge, file or de-burring tool.
- Chamfer (bevel) the end of the pipe 10° - 15°.



3. Clean and Dry Pipe and Fittings

- Remove surface dirt, grease or moisture with a clean dry cloth.



4. Dry Fit

- With light pressure, pipe should go one half to one third of the way into the fitting hub. Pipe and fittings that are too tight or too loose should not be used.



5. Applicator

- Use an applicator that is one half the size of the pipe's diameter.
- Too large an applicator will force excess primer or cement into the inside of the fitting. Too small an applicator will not apply sufficient cement.



6. Coat Surface with Cement

- Stir or shake the cement prior to use.
- Apply a full even layer of cement to the pipe surface to a point 1/2" beyond the hub



depth. Aggressively work the cement into the surface.

- Without re-dipping the applicator in the cement, apply a thin layer of cement to the fitting socket aggressively working it into the surface.

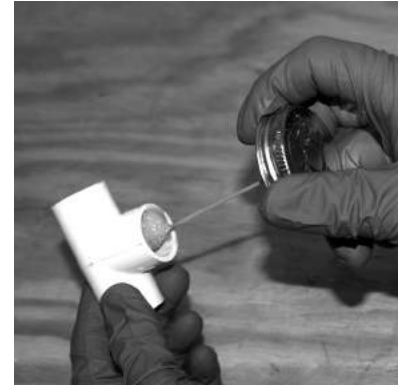

- Do not allow cement to puddle or accumulate inside the system.
- Solvent cement should conform to ASTM F 493 as shown in the accompanying table. All purpose cement is not recommended.
- Primer is not required for FlowGuard Gold® one-step cement, but may be used. Check local code requirements.

7. Join Pipe and Fittings

- Assemble pipe and fittings quickly while cement is fluid. If cement has hardened, cut pipe, dispose of fitting and start over.



- Insert pipe into fitting hub giving a quarter turn ensuring an even distribution of cement within the joint.
- Once the pipe contacts the socket bottom hold pipe and fitting together until the pipe does not back out.
- Align all piping system components properly without strain. Do not bend or pull pipe into position after being solvent welded.

⚠ WARNING

Primers and cements are extremely flammable and may be explosive. Do not store or use near heat or open flame, or death or serious injury may occur.

- Solvent fumes created during the joining process are heavier than air and may be trapped in newly installed piping systems.
- Ignition of the solvent vapors caused by spark or flame may result in injury or death from explosion or fire.
- Read and obey all manufacturers' warnings and any instructions pertaining to primers and cements.
- Provide adequate ventilation to reduce fire hazard and to minimize inhalation of solvent vapors when working with cements, primers and new piping systems.

- See table for recommended set and cure times.
- Remove excess cement from the exterior. A properly made joint will show a continuous bead of cement around the perimeter. If voids appear sufficient cement may not have been applied and joint failure may result.



1/2" – 4" Iron Pipe Size ABS, PVC and CPVC Pipe and Fitting Systems

1. Cut Pipe

- Cut pipe square with the axis. All joints are sealed at the base of the fitting hub. An angled cut may result in joint failure.
- Acceptable tools include ratchet type pipe cutter, miter saw, reciprocating saw, mechanical cut off saw with carbide tipped blade or wheel type pipe cutter. Wheel type pipe cutters must employ a blade designed to cut plastic pipe. Ratchet cutters should be sharpened regularly.
- If any indication of damage or cracking is evident at the pipe end, cut off at least 2" of pipe beyond any visible cracks.



2. Remove Burrs and Bevel

- Remove all pipe burrs from inside and outside diameter of pipe with a knife edge, file or de-burring tool.



- Chamfer (bevel) the end of the pipe 10° - 15°.



3. Clean and Dry Pipe and Fittings

- Remove surface dirt, grease or moisture with a clean dry cloth.



4. Dry Fit

- With light pressure, pipe should go one half to one third of the way into the fitting hub. Pipe and fittings that are too tight or too loose should not be used.



5. Applicator

- Use an applicator that is one half the size of the pipe's diameter. Daubers, natural bristle brushes or swabs are recommended. Rollers are not recommended.
- Too large an applicator will force excess primer or cement into the inside of the fitting. Too small an applicator will not apply sufficient cement.

6. Coat Surface with Primer

- Apply primer to the fitting socket aggressively working it into the surface.



- Apply primer to the pipe surface to a point 1/2" beyond the hub depth. Aggressively work the primer into the surface.

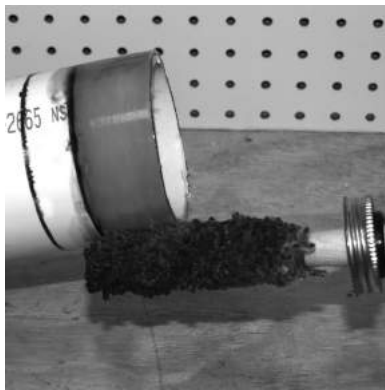

- Apply a second coat of primer to the fitting socket aggressively working it into the surface.



- More applications of primer may be required on hard surfaces or cold weather conditions.
- Once the surface is primed remove all puddles of excess primer from the fitting socket.
- Primer should conform to ASTM F 656.
- The use of primer for ABS is not recommended. Check local code requirements.

7. Coat Surface with Cement

- Cement must be applied while primer is wet.
- Stir or shake the cement prior to use.

- Apply a full even layer of cement to the pipe surface to a point 1/2" beyond the hub depth. Aggressively work the cement into the surface.



- Without re-dipping the applicator in the cement, apply a medium layer of cement to the fitting socket aggressively working it into the surface. On bell end pipe do not coat beyond the socket depth.



- Apply a second full coat of cement to the pipe surface aggressively working it in.



- Do not allow cement to puddle or accumulate inside the system.
- Solvent cement should conform to the appropriate ASTM standard for the piping system as shown in the accompanying table. All purpose cement is not recommended.

8. Join Pipe and Fittings



- Assemble pipe and fittings quickly while cement is fluid. If cement has hardened, cut pipe, dispose of fitting and start over.
- Insert pipe into the fitting hub giving a quarter turn as the pipe is being inserted, ensuring an even distribution of the cement within the joint. Do not quarter turn the pipe after contact with socket bottom.
- Once the pipe contacts the socket bottom hold pipe and fitting together until the pipe does not back out.
- See table for recommended set and cure times.



- Remove excess cement from the exterior. A properly made joint will show a continuous bead of cement around the perimeter. If voids appear sufficient cement may not have been applied and joint failure may result.
- Align all piping system components properly without strain. Do not bend or pull pipe into position after being solvent welded.

WARNING

Primers and cements are extremely flammable and may be explosive. Do not store or use near heat or open flame, or death or serious injury may occur.

- Solvent fumes created during the joining process are heavier than air and may be trapped in newly installed piping systems.
- Ignition of the solvent vapors caused by spark or flame may result in injury or death from explosion or fire.
- Read and obey all manufacturers' warnings and any instructions pertaining to primers and cements.
- Provide adequate ventilation to reduce fire hazard and to minimize inhalation of solvent vapors when working with cements, primers and new piping systems.

6" and Larger Iron Pipe Size ABS, PVC and CPVC Pipe and Fitting Systems

Joining larger diameter piping systems, particularly for pressure applications, requires a higher degree of skill. Proper installation technique is critical. Close attention to the steps below will help professional mechanics to complete successful installations.

1. Cut Pipe



- Cut pipe square with the axis. All joints are sealed at the base of the fitting hub. An angled cut may result in joint failure.
- Acceptable tools include reciprocating saw, mechanical cut off saw with carbide tipped blade or other appropriate tool.
- If any indication of damage or cracking is evident at the (tube / pipe) end, cut off at least 2" of pipe beyond any visible cracks.

2. Remove Burrs and Bevel

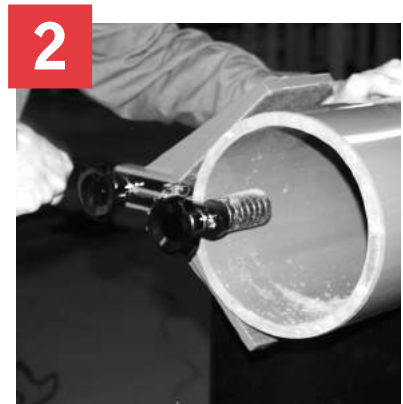

- Remove all pipe burrs from inside and outside diameter of pipe with a deburring tool.
- Chamfer (bevel) the end of the pipe 10° - 15°. Powered and manual chamfering tools are available.

3. Clean and Dry Pipe and Fittings



- Remove surface dirt, grease or moisture with a clean dry cloth.

4. Mark Insertion Depth

- Measure the fitting hub depth. Using a pipe wrap as a straight edge mark the insertion depth plus 2" in a heavy continuous line around the circumference of the pipe.



5. Dry Fit

- With light pressure, pipe should go one half to one third of the way into the fitting hub. Pipe and fittings that are too tight or too loose should not be used.



6. Applicator

- Use an applicator that is one half the size of the pipe's diameter. Use of an appropriately sized applicator will ensure that adequate cement is applied. Natural bristle brushes or swabs are recommended. Rollers are not recommended.
- Too small an applicator will not apply sufficient cement.

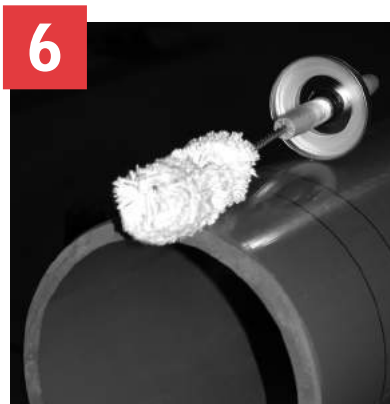

7. Crew Size

- Working rapidly, especially in adverse weather conditions, will improve installations. For 6" to 8" diameters a crew size of 2 to 3 mechanics is required. For 10" pipe diameters and larger a crew of 3 to 4 mechanics may be required.

8. Coat Surface with Primer

- Apply primer to the fitting socket aggressively working it into the surface.



- Apply primer to the pipe surface to a point 1/2" beyond the hub depth. Aggressively work the primer into the surface.



- Apply a second coat of primer to the fitting socket aggressively working it into the surface.
- More applications of primer may be required on hard surfaces or cold weather conditions.



- **NOTICE:** Pipe diameters 6" and larger must be installed using IPS P-70 or Oatey Industrial Grade primers.

⚠ WARNING

Primers and cements are extremely flammable and may be explosive. Do not store or use near heat or open flame, or death or serious injury may occur.

- Solvent fumes created during the joining process are heavier than air and may be trapped in newly installed piping systems.
- Ignition of the solvent vapors caused by spark or flame may result in injury or death from explosion or fire.
- Read and obey all manufacturers' warnings and any instructions pertaining to primers and cements.
- Provide adequate ventilation to reduce fire hazard and to minimize inhalation of solvent vapors when working with cements, primers and new piping systems.

- Once the surface is primed remove all puddles of excess primer from the fitting socket.
- The use of primer for ABS is not recommended. Check local code requirements.

9. Coat Surface with Cement

- Cement must be applied while primer is wet. It is ideal if one mechanic applies the primer while a second immediately applies the cement.
- Stir or shake the cement prior to use.
- Apply a full even layer of cement to the pipe surface to a point $\frac{1}{2}$ " beyond the hub depth. Aggressively work the cement into the surface.



- Apply a medium layer of cement to the fitting socket aggressively working it into the surface. On bell end pipe do not coat beyond the socket depth.



- Apply a second full coat of cement to the pipe surface aggressively working it in.



- Do not allow cement to puddle or accumulate inside the system.

- Solvent cement should conform to the appropriate ASTM standard for the piping system as shown in the accompanying table. Heavy bodied cement is recommended. All purpose cement is not recommended

- **NOTICE:** CPVC Schedule 80 systems must be installed using IPS 714 or Oatey CPVC Heavy Duty Orange solvent cements.

10. Join Pipe and Fittings

- Assemble pipe and fittings quickly while cement is fluid. If cement has hardened, cut pipe, dispose of fitting and start over.
- It is very important that the pipe is fully inserted to the fitting stop at the bottom of the fitting. Large diameter pipe is heavy and can develop significant resistance during insertion. The use of a pulling tool designed for plastic piping systems is recommended.



! WARNING

Primers and cements are extremely flammable and may be explosive. Do not store or use near heat or open flame, or death or serious injury may occur.

- Solvent fumes created during the joining process are heavier than air and may be trapped in newly installed piping systems.
- Ignition of the solvent vapors caused by spark or flame may result in injury or death from explosion or fire.
- Read and obey all manufacturers' warnings and any instructions pertaining to primers and cements.
- Provide adequate ventilation to reduce fire hazard and to minimize inhalation of solvent vapors when working with cements, primers and new piping systems.

! CAUTION

Failure to follow proper installation practices, procedures, or techniques may result in personal injury, system failure or property damage.

- Use a solvent cement / primer applicator that is 1/2 the size of the pipe's diameter. Too large an applicator will result in excess cement inside the fitting. Too small an applicator will not apply sufficient cement.
- Cut pipe square.
- Do not use dull or broken cutting tool blades when cutting pipe.
- Do not test until recommended cure times are met.
- Align all piping system components properly without strain. Do not bend or pull pipe into position after being solvent welded.

- Measure to verify that the pipe has been inserted to within 2" of the insertion line.



- To ensure joint integrity, once insertion is complete, the pulling tool can be used to hold the joint in place during set time and also to ensure that the pipe does not back out.



- See table for recommended set and cure times.

- Remove excess cement from the exterior. A properly made joint will show a continuous bead of cement around the perimeter. If voids appear sufficient, cement may not have been applied and joint failure may result.



- Align all piping system components properly without strain. Do not bend or pull pipe into position after being solvent welded.



Solvent Cements

Pipe and Fitting System	Diameter (in.)	Solvent Cement Standard	Cement Color (common usage, check local code)	Description	Primer (common usage, check local code)
ABS DWV	1½ - 6	ASTM D 2235	Black	Regular or Medium-Bodied	Not Recommended
FlowGuard Gold® and ReUze® CTS CPVC	½ - 2	ASTM F 493	Yellow	Regular-Bodied	Optional
CPVC Sch. 80	½ - 2	ASTM F 493	IPS 714 or Oatey CPVC Heavy Duty Orange	Heavy-Bodied	IPS P-70 or Oatey Industrial Grade
CPVC Sch. 80	2½ - 8	ASTM F 493	IPS 714 or Oatey CPVC Heavy Duty Orange	Heavy-Bodied	IPS P-70 or Oatey Industrial Grade
CPVC Sch. 40 ChemDrain	1¼ - 8	ASTM F 493	ChemDrain Mustard Yellow (Required)	Heavy-Bodied	6" and larger: IPS P-70 or Oatey Industrial Grade required
PVC DWV or Sch. 40 Pressure	½ - 4	ASTM D 2564	Clear	Regular or Medium-Bodied	Required ASTM F 656
PVC DWV or Sch. 40 Pressure	6 - 16	ASTM D 2564	Clear or Grey	Medium or Heavy-Bodied	Required ASTM F 656
PVC Sch. 80	¼ - 2	ASTM D 2564	Grey	Medium or Heavy-Bodied	Required ASTM F 656
PVC Sch. 80	2½ - 16	ASTM D 2564	Grey	Heavy-Bodied	IPS P-70 or Oatey Industrial Grade

NOTICE: Aerosol or spray-on type primers/solvent cements are not recommended. The practice of aggressively scouring the pipe and fittings with both primer and solvent cement is an integral part of the joining process. Not working the primer or solvent cement into the pipe or fitting could cause potential system failure or property damage.

WARNING

Primers and cements are extremely flammable and may be explosive. Do not store or use near heat or open flame, or death or serious injury may occur.

- Solvent fumes created during the joining process are heavier than air and may be trapped in newly installed piping systems.
- Ignition of the solvent vapors caused by spark or flame may result in injury or death from explosion or fire.
- Read and obey all manufacturers' warnings and any instructions pertaining to primers and cements.
- Provide adequate ventilation to reduce fire hazard and to minimize inhalation of solvent vapors when working with cements, primers and new piping systems.

Applicator Types

Nominal Pipe Size (in.)	Applicator Type		
	Dauber	Brush Width (in.)	Swab Length (in.)
¼	A	½	NR
⅜	A	½	NR
½	A	½	NR
¾	A	1	NR
1	A	1	NR
1¼	A	1	NR
1½	A	1 - 1½	NR
2	A	1 - 1½	NR
2½	NR	1½ - 2	NR
3	NR	1½ - 2½	NR
4	NR	2 - 3	3
6	NR	3 - 5	3
8	NR	4 - 6	7
10	NR	6 - 8	7
12	NR	6 - 8	7
14	NR	7 - 8	7
16	NR	8+	8

A = Acceptable

NR = Not Recommended

NOTICE: Rollers are not recommended.

Joint Curing

The joint should not be disturbed until it has initially set. The chart below shows the recommended initial set and cure times for ABS, PVC and CPVC in iron pipe size diameters as well as for FlowGuard Gold® and ReUze® CTS CPVC.

Recommended Initial Set Times

Temperature Range	Diameter ½" to 1¼"	Diameter 1½" to 3"	Diameter 4" to 8"	Diameter 10" to 16"
60° - 100° F	15 min	30 min	1 hr	2 hr
40° - 60° F	1 hr	2 hr	4 hr	8 hr
0° - 40° F	3 hr	6 hr	12 hr	24 hr

NOTICE

A joint should not be pressure tested until it has cured. The exact curing time varies with temperature, humidity, and pipe size. The presence of hot water extends the cure time required for pressure testing. Pressurization prior to joint curing may result in system failure.

Recommended Curing Time Before Pressure Testing

RELATIVE HUMIDITY 60% or Less*	CURE TIME Diameter ½" to 1¼"		CURE TIME Diameter 1½" to 3"		CURE TIME Diameter 4" to 8"		CURE TIME Diameter 10" to 16"
Temperature Range During Assembly and Cure Periods	Up to 180 psi	Above 180 to 370 psi	Up to 180 psi	Above 180 to 315 psi	Up to 180 psi	Above 180 to 315 psi	Up to 100 psi
60° - 100° F	1 hr	6 hr	2 hr	12 hr	6 hr	24 hr	24 hr
40° - 60° F	2 hr	12 hr	4 hr	24 hr	12 hr	48 hr	48 hr
0° - 40° F	8 hr	48 hr	16 hr	96 hr	48 hr	8 days	8 days

*For relative humidity above 60%, allow 50% more cure time.

The above data are based on laboratory tests and are intended as guidelines.

For more specific information, contact should be made with the cement manufacturer.

*Average number of joints per Quart for Cement and Primer (Source: IPS Weld-on)

Pipe Diameter	½"	¾"	1"	1½"	2"	3"	4"	6"	8"	10"	12"	15"	18"
Number of Joints	300	200	125	90	60	40	30	10	5	2 to 3	1 to 2	¾	½

For Primer: double the number of joints shown for cement.

* These figures are estimates based on IPS Weld-on laboratory tests.

Due to many variables in the field, these figures should be used as a general guide only.

Flanges

For systems where dismantling is required, flanging is a convenient joining method. It is also an easy way to join plastic and metallic systems.

Installation

1. Join the flange to the pipe using the procedures shown in the solvent cementing or threading sections.
2. Use a full faced elastomeric gasket which is resistant to the chemicals being conveyed in the piping system. A gasket $\frac{1}{8}$ " thick with a Durometer, scale "A", hardness of 55 -80 is normally satisfactory.
3. Align the flanges and gasket by inserting all of the bolts through the mating flange bolt holes. Be sure to use properly sized flat washers under all bolt heads and nuts.

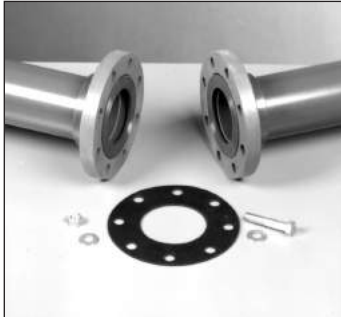

4. Sequentially tighten the bolts corresponding to the patterns shown below. New bolts and nuts should be used for proper torque.
5. Ensure that the mating surfaces are in direct contact. A gap between the flange face and mating surface may result in flange failure. Do not connect to lug type appurtenances without additional flange support.
6. Use a torque wrench to tighten the bolts to the torque values shown below.
7. Use of thread lubricant will ensure proper torque. Confirm that the thread lubricant is chemically compatible with pipe and fittings.



Recommended Torque

Pipe Size In Inches	No. Bolt Holes	Bolt Diameter	Recommended Torque ft/lbs
$\frac{1}{2}$	4	$\frac{1}{2}$	10 - 15
$\frac{3}{4}$	4	$\frac{1}{2}$	10 - 15
1	4	$\frac{1}{2}$	10 - 15
$1\frac{1}{4}$	4	$\frac{1}{2}$	10 - 15
$1\frac{1}{2}$	4	$\frac{1}{2}$	10 - 15
2	4	$\frac{5}{8}$	20 - 30
$2\frac{1}{2}$	4	$\frac{5}{8}$	20 - 30
3	4	$\frac{5}{8}$	20 - 30
4	8	$\frac{5}{8}$	20 - 30
6	8	$\frac{3}{4}$	33 - 50
8	8	$\frac{3}{4}$	33 - 50
10	12	$\frac{7}{8}$	53 - 75
12	12	$\frac{7}{8}$	53 - 75

Note: Flanges meet the bolt-pattern requirements of ANSI / ASME B 16.5

NOTICE

- Exceeding recommended flange bolt torque may result in component damage, system failure and property damage.
- Use the proper bolt tightening sequence as marked on the flange.
- Make sure the system is in proper alignment.
- Flanges may not be used to draw piping assemblies together.
- Flat washers must be used under every nut and bolt head.
- Ensure that the mating surfaces are in direct contact. A gap between the flange face and mating surface may result in flange failure.

FLANGE BOLT TIGHTENING SEQUENCE

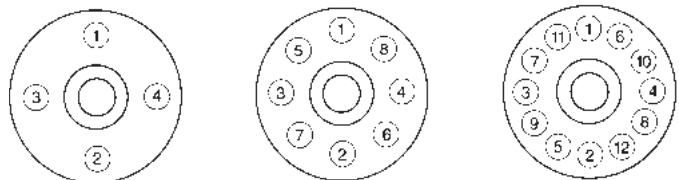

Pressure Rating of PVC and CPVC Flanges at Elevated Temperatures

System Operating Temp. Temperature °F (C)		70 (23)	80 (27)	90 (32)	100 (38)	110 (43)	120 (49)	130 (54)	140 (60)	150 (66)	160 (71)	170 (77)	180 (82)	200 (93)
Pressure Rating (psi)	$\frac{1}{2}$ " - 6"	PVC	150	132	113	93	75	60	45	33	NR	NR	NR	NR
		CPVC	150	144	137	123	111	98	87	75	68	60	NR	NR

NR = Not Recommended

Threaded Joints and Threading of PVC and CPVC Pipe

Charlotte Pipe generally recommends socket (solvent cement) jointing for thermoplastic piping systems. Threaded systems may be used for smaller-size, low-pressure plastic systems, if desired. Transitions to metal or other dissimilar materials may be completed using molded male or female threaded adapters or cut threads on Schedule 80 pipe or flanges.

Only Schedule 80 PVC and Schedule 80 CPVC pipe can be threaded. Schedule 40 or SDR pipe cannot be threaded; molded threaded adapters must be used on those systems.

The pressure rating of molded or cut threads must be derated by an additional 50% beyond the pressure rating for pipe and fittings. See pressure/temperature derating information in this technical manual for systems exposed to operating conditions above 73°F.

NOTICE

Do not exceed the maximum working pressure of any system components including pipe, fittings, valves, molded or cut threads, unions, mechanical coupling or flanges.

- The pressure rating of all components must be reduced at temperatures above 73 degrees F. Refer to de-rating table in this manual.
- Exceeding the maximum working temperature or pressure of the system may result in system failure and property damage.

Pressure Rating for PVC Schedule 80 Unions

Size	Unions	
	Socket Type	Threaded
	Max Working Pressure @ 73°F	Max Working Pressure @ 73°F
½"	235 psi	235 psi
¾"	235 psi	235 psi
1"	235 psi	235 psi
1¼"	235 psi	235 psi
1½"	235 psi	235 psi
2"	235 psi	200 psi
3"	235 psi	185 psi

Maximum Pressure Rating for PVC and CPVC Piping Systems With Threaded Fittings or Threaded Pipe in Pressure Applications

Size	Type	Pressure Rating (PSI) @								
		73 °F	80 °F	90 °F	100 °F	110 °F	120 °F	130 °F	140 °F	150 °F
1/2"	PVC Sch. 40	300	264	225	186	150	120	90	66	NR
	PVC Sch. 80 / CPVC Sch. 80	425	374	319	264	213	170	128	94	NR
3/4"	PVC Sch. 40	240	211	180	149	120	96	72	53	NR
	PVC Sch. 80 / CPVC Sch. 80	345	304	259	214	173	138	104	76	NR
1"	PVC Sch. 40	225	198	169	140	113	90	68	50	NR
	PVC Sch. 80 / CPVC Sch. 80	315	277	236	195	158	126	95	69	NR
1-1/4"	PVC Sch. 40	185	163	139	115	93	74	56	41	NR
	PVC Sch. 80 / CPVC Sch. 80	260	229	195	161	130	104	78	57	NR
1-1/2"	PVC Sch. 40	165	145	124	102	83	66	50	36	NR
	PVC Sch. 80 / CPVC Sch. 80	235	207	176	146	118	94	71	52	NR
2"	PVC Sch. 40	140	123	105	87	70	56	42	31	NR
	PVC Sch. 80 / CPVC Sch. 80	200	176	150	124	100	80	60	44	NR
3"	PVC Sch. 40	130	114	98	81	65	52	39	29	NR
	PVC Sch. 80 / CPVC Sch. 80	185	163	139	115	93	74	56	41	NR
4"	PVC Sch. 40	110	97	83	68	55	44	33	24	NR
	PVC Sch. 80 / CPVC Sch. 80	160	141	120	99	80	64	48	35	NR
6"	PVC Sch. 40	90	79	68	56	45	36	27	20	NR

Note: Threading of PVC Schedule 40 and CPVC Schedule 80 pipe is not recommended.

Threading pipe over 4" in diameter is not recommended.

Please see the Flanges and Unions Section of this manual for maximum working pressure of piping systems incorporating those fittings at elevated temperatures.

Procedure for Cutting Threads in Schedule 80 Pipe

1. Cutting

The pipe must be cut square using a power saw, a miter box, or a plastic pipe cutter. Burrs should be removed using a knife or deburring tool.

2. Threading

Threads can be cut using either hand held or power threading equipment. The cutting dies should be clean, sharp, and in good condition. Special dies for cutting plastic pipe are available and are recommended.

When using a hand threader, the dies should have a 5° to 10° negative front rake. When using a power threader, the dies should have a 5° negative front rake and the die heads should be self-opening. A slight chamfer to lead the dies will speed production. However, the dies should not be driven at high speeds or with heavy pressure.

When using a hand held threader, the pipe should be held in a pipe vise. To prevent crushing or scoring of the pipe, a protective wrap such as emery paper, canvas, rubber, or a light metal sleeve should be used.

Insert a tapered plug into the end of the pipe to be threaded. This plug will provide additional support and prevent distortion of the pipe in the threading area.

It is recommended that a water soluble machine oil, chemically compatible with PVC and CPVC, be used during the threading operation. Also, clearing the cuttings from the die is highly recommended.

Do not over-thread the pipe. Consult the diagram and table showing ASTM F 1498 dimensions for American Standard Taper pipe threads. Periodically check the threads with a ring gauge to ensure that the threads are accurate. The tolerance is $\pm 1\frac{1}{2}$ turns.

*Trademark of the E.I. DuPont Company



Installation of Threaded Connections

1. Make sure the threads are clean. Charlotte Pipe recommends Teflon* tape as a sealant for threaded connections. Use a good quality Teflon tape which has .4 minimum density, .003" thick, .50% elongation and chemically inert.
2. Wrap the Teflon tape around the entire length of the threads; start with two wraps at the end and wrap all threads overlapping half the width of the tape. Wrap in the direction of the threads on each wind.
3. Make threaded connections and hand tighten. Further tighten approximately one turn past hand tight using a strap wrench only. Do not use common wrenches or tools designed for metallic pipe systems.

NOTICE

Piping systems differ in chemical resistance. Pipe or fittings may be damaged by contact with products containing incompatible chemicals resulting in property damage.

- Verify that paints, thread sealants, lubricants, plasticized PVC products, foam insulations, caulks, leak detectors, insecticides, termiticides, antifreeze solutions, pipe sleeve, firestop materials or other materials are chemically compatible with ABS, PVC or CPVC.
- Do not use edible oils such as Crisco® for lubricant.
- Read and follow chemical manufacturer's literature before using with piping materials.

NOTICE: Charlotte does **not** recommend pipe joint compounds, pastes or lubricants for thermoplastic pipe as the use of an incompatible compound may result in the degradation or failure of the plastic pipe or fittings.

NOTICE

Exceeding recommended torque for threaded connections may result in component damage, system failure and property damage.

Notes on Threaded Connections:

- Metallic male pipe threads exert high stress levels on female plastic pipe threaded fittings and should be avoided wherever possible.
- Use plastic threaded CTS CPVC male adaptors in cold water applications only.
- Make threaded connections on FlowGuard Gold® CPVC systems using Charlotte® brass transition fittings. These fittings are available in male, female and drop-ear ell configurations.
- Only join to threaded components conforming to ANSI/ASME B 1.20.1 or ASTM F 1498.

⚠ WARNING

Testing with or use of compressed air or gas in PVC / ABS / CPVC pipe or fittings can result in explosive failures and cause severe injury or death.

AIR/GAS



- NEVER test with or transport/store compressed air or gas in PVC / ABS / CPVC pipe or fittings.
- NEVER test PVC / ABS / CPVC pipe or fittings with compressed air or gas, or air over water boosters.
- ONLY use PVC / ABS / CPVC pipe for water or approved chemicals.
- Refer to warnings in PPFA User Bulletin 4-80 and ASTM D 1785.

Notice to reduce the risk of property damage:

- Never use pneumatic tools for tightening.
- Never apply more than light pressure on male brass or CPVC threaded fitting when clamping in a vise.
- Never clamp female brass transition fittings in a vise.

NOTICE

Use of FlowGuard Gold® CTS CPVC all-plastic threaded male adapters in hot water applications may result in system failure and property damage.

- Use plastic threaded CTS CPVC male adapters in cold water applications only.
- Use CTS CPVC x brass threaded transition fittings for hot water applications.
- Do not use compression fittings with brass ferrules to connect to CTS CPVC pipe or fittings where water temperatures will exceed 140 degrees F.
- CPVC pipe can be used with standard brass ferrules to make compression connections where the operating temperature will not exceed 140°F. Apply Teflon (PTFE) tape over the ferrule to allow for the dissimilar thermal expansion and contraction characteristics of the metal ferrule and the plastic pipe.

The following chart shows the correct amount of tape and torque required to make a properly functioning assembly.

Installation of Brass and CPVC Threaded Fittings			
Pipe Size	Torque Setting		Teflon Tape
	Brass Threaded Fittings	CPVC Threaded Fittings	
½"	14 ft.lbs.	3 to 5 ft.lbs.	½" width
¾"	18 ft.lbs.	4 to 6 ft.lbs.	½" width
1"	24 ft.lbs.	5 to 7 ft.lbs.	½" width
1¼"	30 to 60 ft.lbs.	5 to 7 ft.lbs.	1" width
1½"	23 to 34 ft.lbs.	6 to 8 ft.lbs.	1" width
2"	36 to 50 ft.lbs.	8 to 10 ft.lbs.	1" width

Note: 1 foot pound = 12 inch pounds

External Taper Thread Dimensions

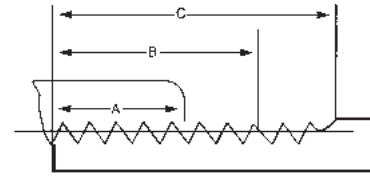

*Per ANSI/AME B1.20.1 and ASTM F 1498

PIPE		* EXTERNAL THREAD			
Nominal Size In Inches	Outside Diameter In Inches (D)	Number of Threads Per Inch	Normal Engagement By Hand In Inches (A)	Length of Effective Thread In Inches (B)	Total Length: End of Pipe to Vanish Point In Inches (C)
¼	.540	18	.228	.4018	.5946
⅜	.675	18	.240	.4078	.6006
½	.840	14	.320	.5337	.7815
¾	1.050	14	.339	.5457	.7935
1	1.315	11½	.400	.6828	.9845
1¼	1.660	11½	.420	.7068	1.0085
1½	1.900	11½	.420	.7235	1.0252
2	2.375	11½	.436	.7565	1.0582
2½	2.875	8	.682	1.1375	1.5712
3	3.500	8	.766	1.2000	1.6337
4	4.500	8	.844	1.3000	1.7337
6	6.625	8	.958	1.5125	1.9462
8	8.625	8	1.063	1.7125	2.1462

Important Information for Fittings with Plastic or Metal Nuts:

P-Traps and Trap Adapters

NOTICE

Pipe or fittings may be damaged by contact with products containing incompatible chemicals, resulting in property damage.

- Verify that paints, thread sealants, lubricants, plasticized PVC products, foam insulations, caulks, leak detectors, insecticides, termiticides, antifreeze solutions, pipe sleeve, firestop materials or other materials are chemically compatible with ABS, PVC, or CPVC.
- Do not use edible oils such as Crisco® for lubricant.

Exceeding recommended torque for threaded connections may result in component damage, system failure, and property damage.

Never use thread sealant when installing a P-Trap or a Trap adapter with a plastic or metallic nut. Use of thread sealants could cause seal separation or cause damage to the fitting through over-tightening.

Always hand-tighten threaded connections, plus approximately one turn. Plastic or metal nuts should be tightened with a strap wrench only. Never use common wrenches or tools designed for metallic pipe systems.

WARNING! To reduce the risk of death or serious injury, read and follow important safety, installation and application information at www.charlottepipe.com



For additional safety, installation and application information please call 800-438-6091. You may also get information 24 hours a day by calling our fax-on-demand number at 800-745-9382 or by visiting our website at www.charlottepipe.com.

Failure to follow safety and installation instructions may result in death, serious injury or property damage.

Joining Roll-Grooved Pipe

Roll-grooved PVC pipe is designed for use with conventional gasketed mechanical couplings. It offers a method of joining which is quick and convenient, and it can be used in applications where frequent assembly and disassembly are desirable.

Installation

1. Consult with the manufacturer of the couplings for recommendations on the coupling style(s) designed for use with PVC pipe and the gasket material which is suitable for the intended service.
 
2. Check the pipe ends for any damage, roll marks, projections, or indentations on the outside surface between the groove and the end of the pipe. This is the sealing area, and it must be free of any defects.
3. Disassemble the coupling and remove the gasket. Inspect for any damage and make sure the gasket material is suitable for the intended service. Apply a thin coat of silicone lubricant to the gasket tips and the outside of the gasket.
4. Slide the gasket onto the end of one length of pipe so that it is flush with the end. Align and bring the end of another length of pipe together while sliding the gasket back over this junction. The gasket should be centered between the grooves and should not extend into the groove on either length of pipe.
5. Place the coupling housings over the gasket. The housing keys should engage into the grooves. Insert the bolts and apply the nuts. Tighten to "finger tight."
6. Using a wrench, alternately tighten the nuts to the coupling manufacturer's specifications. Over tightening is not necessary, and uneven tightening may cause gasket pinching.
 

Antifreeze Solutions - Pressure Testing CPVC and PVC Piping at Reduced Temperature

Glycerin antifreeze solutions are recommended for use with FlowGuard Gold® and Corzan® water distribution systems and for PVC pressure and DWV applications.

Glycerin antifreeze should be diluted to the appropriate concentration that provides adequate protection for the intended application. Maximum freeze protection for glycerin-water solutions is -51.7°F (-46.5°C) and occurs when the weight percent of glycerin is 66.7%. The effectiveness of a glycerin/water antifreeze solution diminishes above this concentration. Freeze points of glycerin-water solutions follow:

Freezing Points of Glycerin-Water Solutions (weight %)

Glycerin by weight (%)	Freeze Point °F (°C)
0	32.0 (0.0)
10	29.1 (-1.6)
20	23.4 (-4.8)
30	14.9 (-9.5)
40	4.3 (-15.4)
50	-9.4 (-23.0)
60	-30.5 (-34.7)
66.7	-51.7 (-46.5)
Greater than 66.7	Not Recommended

Propylene glycol or ethylene glycol antifreeze solutions are suitable for use in pressure testing PVC and CPVC pressure and DWV piping systems as follows:

CAUTION

- Solutions greater than 50% propylene glycol are incompatible with PVC and may cause damage to PVC piping systems.
- Solutions greater than 25% propylene or 50% ethylene are incompatible with CPVC and may cause damage to CPVC piping systems.
- Ethylene glycol is compatible with PVC piping systems up to 100% concentrations.
- 25% Propylene glycol solutions are approved for use with potable water systems and provide freeze protection to about 15°F (-10°C), 50% solutions provide freeze protection to -30°F (-34°C).
- Please see the Chemical Resistance chart contained in this manual for complete chemical resistance data.
- Ethylene glycol solutions are toxic and must therefore be avoided in potable water and food processing systems. 25% ethylene glycol solutions provide freeze protection to about 8°F (-13°C) and 50% solutions provide freeze protection to about -33°F (-36°C).

Antifreeze Solutions for ABS DWV Systems

Only the following antifreeze may be used with or in conjunction with ABS DWV foam core systems:

- 60% glycerol, by weight, in water. Use undiluted.
- 22% magnesium chloride, by weight, in water. Use undiluted.
- "Plastic Pipe Antifreeze" (especially made for plastic pipe).

Do not use any other type antifreeze except those recommended above.

Underground Installation

Trenching

The following trenching and burial procedures should be used to protect the piping system.

1. Excavate the trench in accordance with applicable codes and regulations, ensuring that the sides will be stable under all working conditions.
2. The trench should be wide enough to provide adequate room for the following.
 - A. Joining the pipe in the trench;
 - B. Snaking the pipe from side to side to compensate for expansion and contraction, if required; and
 - C. Filling and compacting the side fills.

The space between the pipe and trench wall must be wider than the compaction equipment used in the compaction of the backfill. Minimum width shall be not less than the greater of either the pipe outside diameter plus 16 inches or the pipe outside diameter times 1.25 plus 12 inches. Trench width may be different if approved by the design engineer.

3. Install foundation and bedding as required by the engineer according to conditions in the trench bottom. Provide firm, stable and uniform bedding for the pipe barrel and any protruding feature of its joint. Provide a minimum of 4 inches of bedding unless rock or unyielding material is encountered in the bottom of the trench, in which case a minimum of 6 inches of bedding shall be used. For more severe conditions the guidelines in ASTM D 2321 should be followed. Blocking should not be used to change pipe grade or to intermittently support pipe over low sections in the trench.
4. To prevent damage to the pipe and disturbance to pipe embedment, a minimum depth of backfill above the pipe should be maintained before allowing vehicles or heavy construction equipment to traverse the pipe trench. Pipe should always be installed at least below the frost level. The minimum depth of cover should be established

by the design engineer based upon an evaluation of specific project conditions. In the absence of an engineering evaluation, Charlotte Pipe recommends referring to Section 7.6 in ASTM D 2321 "Underground Installation of Thermoplastic pipe for Sewers and Other Gravity-Flow Applications."

Bedding and Backfilling

1. Even though sub-soil conditions vary widely from place to place, the pipe backfill should be stable and provide protection for the pipe.
2. The pipe should be surrounded with an aggregate material which is easily worked around the sides of the pipe. Backfilling should be performed in layers of 6 inches with each layer being sufficiently compacted to 85% to 95% compaction.
3. A mechanical tamper is recommended for compacting sand and gravel backfill which contain a significant proportion of fine-grained material, such as silt and clay. If a tamper is not available, compacting should be done by hand.
4. The trench should be completely filled. The backfill should be placed and spread in uniform layers to prevent any unfilled spaces or voids. Large rocks, stones, frozen clods, or other large debris should be removed. ASTM D 2321 standard calls for stone backfill to pass through an 1-1/2" sieve and that rock size should be about 1/10th of the pipe outside diameter. Heavy tampers or rolling equipment should only be used to consolidate only the final backfill.

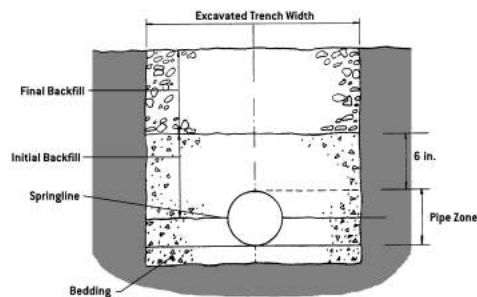

Additional information is contained in ASTM D 2321 "Underground Installation of Thermoplastic pipe for Sewers and Other Gravity-Flow Applications" (non-pressure applications) and in ASTM F 1668 "Construction Procedures for Buried Plastic Pipe." ASTM Standards are copyrighted documents and can be purchased from ASTM International: 100 Barr Harbor Drive West Conshohocken, PA 19428 or "http://www.astm.org."

Note: This section is a general reference guide and should not be considered a complete engineering resource addressing all aspects of design and installation of pipe in buried applications. Charlotte Pipe recommends that a design professional use this manual along with other industry references taking into account sub-surface conditions unique to each project and that all installations be made in accordance with the requirements found in ASTM D 2321 and in compliance with applicable code requirements.

CTS CPVC Under-Slab Installations

FlowGuard Gold® and ReUze® CPVC is suitable for under-slab installations when approved by prevailing plumbing and building codes.

When performing under-slab installations, it is important that the pipe be evenly supported. Charlotte Pipe recommends pressure testing with water prior to backfilling and pouring the slab. Backfill should be clean earth, sand, gravel or other approved material, which must not contain stones, boulders or other materials that may damage or break the piping. The pipe should be protected from damage by tools and equipment used to finish the concrete. Because CPVC does not react to concrete or stucco and is inert to acidic soil conditions, it does not need to be sleeved. **NOTE:** Some code jurisdictions require sleeving at slab penetrations. Verify code requirements prior to installation.

Do not bend FlowGuard Gold® and ReUze® 1/2" and 3/4" pipe in a radius tighter than 18"; 1" pipe should not be bent in a radius tighter than 24".

Check applicable plumbing and building codes before making under-slab installations.

In-Slab Installations

CPVC is not suitable for in-slab radiant heating systems.

CPVC piping can be installed embedded in a concrete slab, because CPVC does not react to concrete or stucco and it is inert to acidic soil conditions.

ABS and PVC Under-Slab Installations

Although PVC or ABS is unaffected by direct contact with or burial in concrete, care must be taken to properly support any piping system when pouring concrete so that the weight of the concrete does not affect the pipe system and that any heat generated by curing concrete does not exceed the capability of the system.

Some codes require sleeving or protection of piping at slab penetrations. While not necessary due to any corrosion issues, always follow applicable code requirements on any installation.

Testing and Inspection

Once the roughing-in is completed on a plastic piping system, it is important to test and inspect all piping for leaks. Concealed work should remain uncovered until the required test is made and approved. When testing, the system should

be properly restrained at all bends, changes of direction, and the end of runs.

There are various types of procedures used for testing installed plastic systems. However, a water or hydrostatic



WARNING

In any test, proper safety procedures and equipment should be used, including personal protective equipment such as protective eyewear and clothing. Installers should always consider local conditions, codes and regulations, manufacturer's installation instructions, and architects'/engineers' specifications in any installation.

test is a technically superior test method for inspecting a completed plastic piping system installation and is the testing procedure recommended by Charlotte Pipe. It is also the most recommended test in most plumbing code standards. The purpose of the test is to locate any leaks at the joints and correct them prior to putting the system into operation. Since it is important to be able to visually inspect the joints, a water test should be conducted prior to closing in the piping or backfilling of underground piping.

Testing DWV System

Water Test

The system should be properly restrained at all bends, changes of direction, and the end of runs. To isolate each floor or section being tested, test plugs are inserted through test tees in the stack. All other openings should be plugged or capped with test plugs or test caps.

When testing Foam Core pipe, always use external caps to eliminate the possibility of leakage through the foam core layer of the pipe.

Fill the system to be tested with water at the highest point. As water fills a vertical pipe it creates hydrostatic pressure. The pressure increases as the height of the water in the vertical pipe increases. Charlotte Pipe recommends testing at 10 feet of hydrostatic pressure (4.3 pounds per square inch.) Filling the system slowly should allow any air in the system to escape as the water rises in the vertical pipe. All entrapped air in the system should be expelled prior to the beginning of the test. Failure to remove entrapped air may give faulty test results.

Once the stack is filled to "ten feet of head," a visual inspection of the section being tested should be made to check for leaks. If a leak is found, the joint must be cut out and a new section installed. Once the system has been

successfully tested, it should be drained and the next section prepared for testing.

⚠ WARNING

Testing with or use of compressed air or gas in PVC / ABS / CPVC pipe or fittings can result in explosive failures and cause severe injury or death.

AIR/GAS



- NEVER test with or transport/store compressed air or gas in PVC / ABS / CPVC pipe or fittings.
- NEVER test PVC / ABS / CPVC pipe or fittings with compressed air or gas, or air over water boosters.
- ONLY use PVC / ABS / CPVC pipe for water or approved chemicals.
- Refer to warnings in PPFA User Bulletin 4-80 and ASTM D 1785.

⚠ WARNING

Testing with or use of compressed air or gas in PVC / ABS / CPVC pipe or fittings can result in explosive failures and cause severe injury or death.

AIR/GAS



- NEVER test with or transport/store compressed air or gas in PVC / ABS / CPVC pipe or fittings.
- NEVER test PVC / ABS / CPVC pipe or fittings with compressed air or gas, or air over water boosters.
- ONLY use PVC / ABS / CPVC pipe for water or approved chemicals.
- Refer to warnings in PPFA User Bulletin 4-80 and ASTM D 1785.

Testing Pressure System

1. Prior to testing, safety precautions should be instituted to protect personnel and property in case of test failure.
2. Conduct pressure testing with water.
3. The piping system should be adequately anchored to limit movement. Water under pressure exerts thrust forces in piping systems. Thrust blocking should be provided at changes of direction, change in size and at dead ends.
4. The piping system should be slowly filled with water, taking care to prevent surge and air entrapment. The flow velocity should not exceed 5-feet per second for PVC and 8-feet per second for CPVC CTS (see Friction Loss and Flow Velocity charts in this manual).
5. All trapped air must be slowly released. All valves and air relief mechanisms should be opened so that the air can be vented while the system is being filled.

6. Once an installation is completed and cured the system should be filled with water and pressure tested in accordance with local code requirements.
7. Any leaking joints or pipe must be cut out and replaced and the line recharged and retested using the same procedure.

NOTICE

Do not exceed the maximum working pressure of any system components including pipe, fittings, valves, molded or cut threads, unions, mechanical coupling or flanges.

- The pressure rating of all components must be reduced at temperatures above 73 degrees F. Refer to de-rating table in this manual.
- Exceeding the maximum working temperature or pressure of the system may result in system failure and property damage.

⚠ WARNING

Entrapped Air

- Pressure surges associated with entrapped air may result in serious personal injury, system failure, and property damage.
- Install air relief valves at the high points in a system to vent air that accumulates during service.
- Failure to bleed trapped air may give faulty test results and may result in an explosion.

The installation tips, warnings and technical information in this Special Considerations section are intended to help improve material selection and installation techniques. The information found in this section enhances but does not replace the information found in other sections of this Technical Manual.

Special Considerations

- FlowGuard Gold CTS CPVC Domestic Water Systems
- Hydronic Applications
- Selection of Materials for Sanitary and Storm Drainage
- Engineered Applications
- Unstable Soil
- Plastics in Multi-Story Construction
- Combustion Gas Venting

FlowGuard Gold® Domestic Water Systems

FlowGuard Gold pipe and fittings are made from a specialty plastic known as chlorinated polyvinyl chloride (CPVC). FlowGuard Gold CPVC is the result of new technology that ensures product toughness year round. FlowGuard Gold water distribution systems are assembled with readily available tools. Solvent cement joints – proven with nearly 50 years of successful service history – help assure the reliability of a FlowGuard plumbing system.

FlowGuard Gold CPVC pipe and fittings are designed, manufactured and listed for domestic water applications. Piping systems using CPVC should be installed by licensed plumbing contractors in accordance with normal industry standards, good plumbing practices and in compliance with applicable plumbing codes, building codes and other regulations.

NOTICE: CPVC Schedule 80 domestic water systems must be installed using IPS P-70 or Oatey Industrial Grade primers and IPS 714 or Oatey CPVC Heavy Duty Orange solvent cements. FlowGuard Gold, the industry-leading hot and cold water system, is typically installed in ½ -2 inch applications.

The Advantages of a FlowGuard Gold® CPVC System

A FlowGuard Gold water distribution system outperforms a metal plumbing system in several important ways:

- It's more energy efficient – with better heat retention and lower hot water heating costs.
- Condensation is reduced – significantly reducing the risk of drip damage.

- It operates quietly – with silent water flow and no banging from water hammer.
- CPVC is resistant to corrosion, pitting and scaling – this means no loss of water pressure and reduced maintenance.

NOTICE

Piping systems differ in chemical resistance. Pipe or fittings may be damaged by contact with products containing incompatible chemicals resulting in property damage.

- Verify that paints, thread sealants, lubricants, plasticized PVC products, foam insulations, caulks, leak detectors, insecticides, termiticides, antifreeze solutions, pipe sleeve, firestop materials or other materials are chemically compatible with ABS, PVC or CPVC.
- Do not use edible oils such as Crisco® for lubricant.
- Read and follow chemical manufacturer's literature before using with piping materials.

Chemical Compatibility With CPVC Products

CPVC domestic water systems have been used successfully for 50 years in new construction, repipe and repair. CPVC products are ideally suited for domestic water applications due to their corrosion resistance. Occasionally, however, CPVC can be damaged by contact with chemicals found in some construction products including thread sealant, fire stopping compounds, pipe sleeves or insulation. Reasonable care needs to be taken to ensure that products coming into contact with CPVC systems are chemically compatible. Charlotte Pipe recommends that CPVC chemical compatibility be confirmed with the manufacturer of any product coming into contact with

NOTICE

Use of FlowGuard Gold® CTS CPVC all-plastic threaded male adapters in hot water applications may result in system failure and property damage.

- Use plastic threaded CTS CPVC male adapters in cold water applications only.
- Use CTS CPVC x brass threaded transition fittings for hot water applications.
- Do not use compression fittings with brass ferrules to connect to CTS CPVC pipe or fittings where water temperatures will exceed 140 degrees F.
- CPVC pipe can be used with standard brass ferrules to make compression connections where the operating temperature will not exceed 140°F. Apply Teflon (PTFE) tape over the ferrule to allow for the dissimilar thermal expansion and contraction characteristics of the metal ferrule and the plastic pipe.

CPVC piping systems. If chemical compatibility with CPVC is in question, Charlotte Pipe recommends isolating the suspect product from contact with CPVC pipe or fittings.

NOTICE: In understanding spray polyurethane foams, there are two general areas of concern for CPVC pipe and fittings; (1) chemical compatibility and (2) potential damage to pipe and fittings due to high temperatures generated as a result of the exothermic chemical reaction during the installation and curing process. It is possible to apply polyurethane foam insulation properly without damage to CPVC pipe and fittings. However, the use of polyurethane foam insulation in conjunction with CPVC has resulted in the failure of CPVC pipe and fittings and property damage. Therefore, Charlotte Pipe and Foundry does not recommend the use of polyurethane spray on foam insulation in conjunction with CPVC pipe and fittings.

Please call Charlotte Pipe at 800/438-6091 or visit our web site www.CharlottePipe.com for the latest CPVC Chemical Compatibility sheet.

Care should be taken to isolate CPVC piping systems from direct contact with heavy concentrations of termiticides. Vinyl piping materials such as CPVC may be damaged by termiticides where they are injected into the annular space between the pipe wall and sleeving material trapping the termiticides against the pipe wall. Common-sense precautions will prevent installation problems.

CTS CPVC Pipe Passing Through Studs

Plastic insulators do not need to be used when CPVC pipe passes through wood studs. However, when CPVC pipe passes through metal studs, some form of protection must be used to isolate the pipe from abrasion and to prevent noise.

Closed-Loop Systems

A closed-loop plumbing system is one in which water from the premises side of the water meter is unable to backflow into the main. This circumstance is becoming more and more prevalent as the result of the growing use of devices such as backflow preventers and pressure-reducing valves.

Allowance must be made for "thermal expansion of the water." Backflow-prevention devices with built-in bypass capabilities, auxiliary pressure-relief valves or bladder-type expansion tanks are several options available to help resolve the problem and to insure long-term system performance.

NOTICE

Piping systems differ in chemical resistance. Pipe or fittings may be damaged by contact with products containing incompatible chemicals resulting in property damage.

- Verify that paints, thread sealants, lubricants, plasticized PVC products, foam insulations, caulks, leak detectors, insecticides, termiticides, antifreeze solutions, pipe sleeve, firestop materials or other materials are chemically compatible with ABS, PVC or CPVC.
- Do not use edible oils such as Crisco® for lubricant.
- Read and follow chemical manufacturer's literature before using with piping materials.

Connecting CTS CPVC to Fixtures or Other Materials

Stub-outs for Plumbing Fixtures

CTS CPVC pipe can be used for stub-outs for lavatories, closets and sinks.

Brass Compression Ferrules

CTS CPVC pipe can be used with standard brass ferrules to make compression connections where the operating temperature will not exceed 140°F. The O.D. of copper tube size (CTS) CPVC pipe is identical to that of copper. We recommend that Teflon (PTFE) tape be applied over the ferrule to allow for the dissimilar thermal expansion and contraction characteristics of the metal ferrule and the plastic pipe that could possibly result in a drip leak over a period of time. **NOTICE:** Do not over-torque the compression connection as over-torquing may result in a cracked pipe. Non-metallic or nylon ferrules are not recommended.

Threaded Fittings

Please see the section of this technical manual for complete information on Threaded Joints.

NOTICE

Use of FlowGuard Gold® CTS CPVC all-plastic threaded male adapters in hot water applications may result in system failure and property damage.

- Use plastic threaded CTS CPVC male adapters in cold water applications only.
- Use CTS CPVC x brass threaded transition fittings for hot water applications.
- Do not use compression fittings with brass ferrules to connect to CTS CPVC pipe or fittings where water temperatures will exceed 140 degrees F.
- CPVC pipe can be used with standard brass ferrules to make compression connections where the operating temperature will not exceed 140°F. Apply Teflon (PTFE) tape over the ferrule to allow for the dissimilar thermal expansion and contraction characteristics of the metal ferrule and the plastic pipe.

Tub Fillers, Showerheads and Outside Sillcocks

CTS CPVC should be connected to tub fillers, showerheads and outside sillcocks with a CPVC to brass threaded transition fitting or a metal nipple. Direct connection to CPVC or CPVC threaded fittings is not recommended.

Water Heaters / Boilers

Instructions from the manufacturer of the water heater and applicable local plumbing and building codes should be followed.

Do not use FlowGuard Gold CTS CPVC pipe or fittings on systems capable of achieving temperatures greater than 180°F.

When FlowGuard Gold CTS CPVC pipe is used with an electric water heater, a CPVC-to-brass transition fitting should be used. CPVC threaded male adapters should not be used to connect to water heaters or connect to metallic nipples in close proximity to water heater.

When connecting to a gas water heater, at least 6 inches of metal nipple or appliance connector should be used so that the CPVC tubing cannot be damaged by the build-up of excessive radiant heat from the draft diverter. Some high-efficiency direct-vent gas water heaters eliminate the radiant heat from the flue and can be piped directly to the water heater. A brass threaded CPVC transition fitting must be used for connection to the water heater.

NOTICE: Do not connect CTS CPVC or Schedule 80 CPVC directly to a boiler due to excessive heat generated. The

maximum recommended temperature and de-rating of working pressure applies to both heat generated from fluid being distributed through pipe system and heat generated from sources external to the pipe system.

CPVC can be connected to tankless gas water heaters using a CPVC-to-brass threaded transition fitting. Verify code requirements prior to installation.

Dimensional Data

For dimensional requirements of FlowGuard Gold® CTS and ReUze® CPVC please see the Dimensional Data section of this manual.

Disinfection

FlowGuard Gold and ReUze® CPVC have been tested and found to be unaffected by chlorine in concentrations up to 3,000 parts per million in water. Normal system disinfection at 50 parts per million chlorine will not harm CPVC.

Elevated-Temperature Performance (T/P Relief Valve Drainage Pipe)

CTS CPVC pipe conforming to ASTM D 2846 is rated for continuous operation at 180°F/100 psi. The following addresses the expected capabilities of CPVC during short-term exposure to temperatures and/or pressures above 180°F/100 psi that may occur from time to time. However, CTS CPVC pipe is not recommended for pressure applications where temperatures will consistently exceed 180°F.

1. Use of CTS CPVC for T/P relief valve drainage lines

CPVC is a suitable material for T/P discharge piping. A CPVC-to-brass transition fitting should be used connecting to T/P relief valve.

FlowGuard Gold pipe and fittings meet the Uniform Plumbing Code short term working pressure requirement of 48 hours at 210°F/150 psi. Furthermore, CPVC pipe is approved for T/P discharge piping under the following model codes:

SBCCI	Standard Plumbing Code - Section 1210.1.
BOCA	BOCA National Plumbing Code - Section P 1506.4.2 (1991)
UPC	Uniform Plumbing Code - Installation Std. IS-20 - Sec. 1007.1.
ICC	International Code Council Section 504.6.2/605.5

2. Short-term elevated pressure performance

CPVC meets the quality control provisions of the ASTM D 2846 Standard (Table 5) which requires that CPVC-CTS systems (pipe, fittings, and cemented joints) have the capability of withstanding short-term pressure tests at 180°F of at least 521 psi for 6 minutes and 364 psi for 4 hours.

Flanges and Unions

Please see the section of this technical manual for complete information on Flanges and Unions.

Horizontal and Vertical Support

Most plumbing and building codes require support for horizontal pipe lines every 3 feet for pipe in ½"-1" diameters, and every 4 feet for pipe with diameters greater than 1". Support spacing should be in accordance with applicable plumbing and building codes.

Vertical CPVC piping should be properly supported and have a mid-story guide, unless thermal expansion requires another design.

The pipe should not be anchored tightly by the support, but secured in a manner to allow for movement caused by thermal expansion and contraction. It is recommended that you use clamps or straps furnished by Charlotte Pipe that allow pipe to remain away from the framing, thus reducing the noise generated when pipe is allowed to rub against wood. Use hangers and clamps that are chemically compatible with CPVC.

HVAC Condensate Drain Lines

NOTICE

Prior to installing PVC or CPVC piping in hydronic applications, it is important to flush the interior of the heat exchangers and the exterior of the condenser coils thoroughly with a mild ionic detergent solution to remove incompatible oils. Failing to do so could result in system failure and property damage.

Verify that all boiler cleaning and sealing chemicals used in hydronic radiant heating systems are compatible with PVC or CPVC. Failure to do so could result in system failure and property damage.

Equipment leaks in refrigeration or HVAC systems may release POE oils or other contaminants into the piping system. These oils and contaminants are incompatible with PVC or CPVC and such exposure may result in pipe or fitting failure regardless of flushing.

Exercise caution when using FlowGuard Gold® CPVC pipe or fittings for HVAC- or refrigerant-condensate lines. Some refrigerant systems contain oils that may damage CPVC products. In HVAC applications, some heat exchangers or condenser coils may contain residual oils from the manufacturing process which can cause cracking of CPVC. Caution should be exercised when installing CPVC in combination hot/air handling units or as condensate-drain lines from air conditioning systems. Confirm the compatibility of CPVC with residual oils prior to installation. The interior of heat exchangers or the exterior of condenser coils may be thoroughly cleaned with a detergent solution to remove incompatible oils prior to piping installation. A rinse with clean water to completely clean the system is advisable as a final flushing. Charlotte Pipe and Foundry will not accept responsibility for failure resulting from exposure to compressor oils in HVAC- or refrigerant-condensate lines.

Low Temperature Recommendation

Like most materials, PVC and CPVC become more brittle at low temperatures, particularly at temperatures below freezing (32°F). Charlotte Pipe and Foundry recommends taking proper precautions when installing systems at low temperatures including providing proper insulation. If a system is designed to operate at temperatures below freezing (32°F), Charlotte Pipe recommends the following:

1. Reduce water hammer pressure surges to a minimum by:
 - a. Using only slow-acting solenoid valves, if any.
 - b. Reducing pump start-up pressure surges with slow start-up motors and rubber expansion devices.
 - c. Not exceeding maximum fluid velocity of 5-feet per second for PVC and 8-feet per second for CPVC CTS.
2. Provide more than minimum Charlotte Pipe recommended support spacing.
3. Thrust blocking at branches, changes in direction and end of runs.
4. Use expansion/contraction devices when temperature changes occur in runs.
5. Strictly follow chemical-resistance recommendations.
6. Protect piping from UV, if applicable.

Cold Weather Considerations For CPVC

NOTICE

In understanding spray polyurethane foams, there are two general areas of concern for CPVC pipe and fittings; (1) chemical compatibility and (2) potential damage to pipe and fittings due to high temperatures generated as a result of the exothermic chemical reaction during the installation and curing process. It is possible to apply polyurethane foam insulation properly without damage to CPVC pipe and fittings. However, the use of polyurethane foam insulation in conjunction with CPVC has resulted in the failure of CPVC pipe and fittings and property damage. Therefore, Charlotte Pipe and Foundry does not recommend the use of polyurethane spray on foam insulation in conjunction with CPVC pipe and fittings.

The following precautions are recommended in cold-weather situations.

1. Freeze Issues

CPVC is a ductile material, which expands and contracts more than metallic plumbing pipe. However, CPVC, like all other piping materials, needs to be protected from freezing. All model plumbing codes require that piping exposed to freezing temperatures be properly insulated.

2. Frozen CPVC Water Lines

Drain the system if overnight temperatures are likely to drop below 32°F. CPVC may split like other materials when water freezes in it.

Immediately take action to eliminate the source of cold air causing the freezing condition, then thaw the water line if possible. If the frozen section of pipe is accessible, heated air can be blown directly onto the frozen area by using a low wattage heater/blower. Also, electrical heat tapes can be applied to the frozen area. **NOTICE:** To avoid damaging the pipe when thawing a frozen CPVC water line, the heat source should not exceed 180°F.

3. Handling

Refrain from unnecessary abuse. Do not drop pipe from trucks, drag pipe on the ground, step on pipe or drop pipe on the ends.

Inspect pipe ends for hairline cracks before making a joint. If any indication of damage or cracking is evident at the tube end, cut off at least 2 inches beyond any visible crack. Do not use dull or broken cutting tools. A wheel-type pipe cutter is recommended.

Store pipe in a heated area whenever possible.

Pressure Rating

For derating of maximum working pressure at elevated temperatures please see the Pressure / Temperature in the Design and Engineering Data section of this manual.

Temperature

For maximum working temperature and derating factors please see the Pressure / Temperature in the Design and Engineering Data section of this manual.

Heat Build-Up

In addition to considering ambient air and operating temperatures in a piping system, piping designers must consider the radiant effect of sunlight when selecting piping material. Testing to the ASTM D 4803 Standard Test Method for Predicting Heat Build-up in PVC Building Products indicates that radiant heat from the sun can increase pipe surface temperatures by 50°F or more, possibly causing a piping system to exceed maximum working temperature or de-rating pressure carrying capability. Painting dark-colored pipe with light-pigmented, water-based paint may reduce, but will not eliminate, heat build-up.

Thermal Expansion

For information on thermal expansion please see Expansion and Contraction in the Design and Engineering Data section of this manual.

Expansion Tanks do not compensate for linear expansion and contraction of the pipe and fittings. Expansion tanks are designed to compensate for the expansion of the liquids within the system.

Testing

Please see the Testing and Inspection section of this manual.

Thermal Conductivity and Sweating of CTS CPVC

Due to its low coefficient of thermal conductivity, FlowGuard Gold® CPVC retains hot water longer and reduces condensation and sweating.

Thermal Conductivity

Thermal conductivity is defined as "transfer of heat from one part to another part of the same body, or from one body to

another in physical contact with it, without appreciable displacement of the particles of the body." This definition leads to the commonly used "K" factor, which refers to thermal conductivity. Note that the units are "Btu per hour" for one square foot of surface and "one degree Fahrenheit per inch" of material thickness.

<u>Material</u>	<u>Btu/h-Sq.Ft.-°/in</u>
CPVC	1.0
PVC	1.3
PEX	2.4
Steel	312.0
Cast Iron	360.0
Copper	2,616.0

Condensation and Sweating

Due to its low coefficient of thermal conductivity, it is often not necessary to insulate FlowGuard Gold CPVC against condensation within conditioned buildings. Two conditions that control sweating of a pipe are (1) the pipe surface temperature, which depends on the temperature of the water inside the pipe and (2) the relative humidity of the air around the pipe. Because each of the factors can vary greatly, it is possible that conditions exist that can cause CPVC pipe to sweat. Under most conditions that cause copper pipe to sweat and drip, FlowGuard Gold pipe will remain free of condensation.

UV Exposure

Please see the Weathering section of this technical manual for complete information on UV Exposure.

Water Hammer Arrestors

Quick closing valves, actuated valves, starting or stopping pumps or rapid increases or decreases in system flow rate can result in pressure surge or "water hammer" capable of damaging PVC or CPVC piping systems. Systems should be designed by the engineer of record and in conformance to local code requirements to manage the effects of pressure surge. In applications where severe or repeated water hammer is encountered, especially at elevated temperatures or in a commercial laundry or commercial kitchen, the use of a water hammer arrestor is advisable.

FlowGuard Gold® and Corzan® Domestic Water Systems Do's and Don'ts

While not a complete list, the following is intended to highlight many of the Do's and Don'ts when installing a FlowGuard Gold and Corzan domestic water system.

Do's

- Do install CPVC Schedule 80 domestic water systems using IPS P-70 or Oatey Industrial Grade primers.
- Do install CPVC Schedule 80 domestic water systems using IPS 714 or Oatey CPVC Heavy Duty Orange solvent cements.
- Installation should be in accordance with normal industry standards, good plumbing practices, applicable plumbing codes, building codes and other regulations.
- Follow recommended safe work practices.
- Follow proper material handling procedures.
- Keep pipe and fittings in original packaging until needed.
- Cover pipe and fittings with opaque tarp when stored outdoors.
- Make certain that thread sealants, gasket lubricants and firestop materials are compatible with CPVC pipe and fittings.
- Use only latex paint if painting is desired.
- Use tools designed for plastic pipe and fittings.
- Cut pipe square.
- Deburr and bevel pipe before solvent cementing.
- Apply primer and cement with an applicator that is one half the size of the pipe's diameter.
- Rotate pipe ¼ to ½ turn as the pipe is being inserted into the fitting socket.
- Avoid puddling of solvent cement in fitting or pipe.
- Follow recommended cure time for the required pipe diameter and temperature.
- Align all piping system components properly without strain. Do not bend or pull pipe into position after being solvent welded.
- Fill lines slowly and bleed all trapped air from the system prior to conducting a hydrostatic test.

- Visually inspect all joints for proper cementing.
- Allow for movement due to thermal expansion and contraction.
- Use pipe straps that fully encircle the tube.
- Drill holes ¼ inch larger than the outside diameter of the pipe or tube when penetrating wood studs.
- Use protective pipe isolators that allow movement when penetrating steel studs.
- Use metallic or tear drop hangers when suspending tube from all thread rod.
- If pipe sleeve is used, verify that it is chemically compatible with CPVC.
- If pipe sleeve is used, extend it 12 inches above and below the slab.
- Backfill and cover underground piping prior to spraying termiticides in preparation for concrete pour.
- Design the system not to exceed the maximum working pressure of all system components including pipe, fittings, valves, unions and flanges. De-rate the pressure rating of all components if the working temperature will exceed 73 degrees Fahrenheit.

NOTICE

In understanding spray polyurethane foams, there are two general areas of concern for CPVC pipe and fittings; (1) chemical compatibility and (2) potential damage to pipe and fittings due to high temperatures generated as a result of the exothermic chemical reaction during the installation and curing process. It is possible to apply polyurethane foam insulation properly without damage to CPVC pipe and fittings. However, the use of polyurethane foam insulation in conjunction with CPVC has resulted in the failure of CPVC pipe and fittings and property damage. Therefore, Charlotte Pipe and Foundry does not recommend the use of polyurethane spray on foam insulation in conjunction with CPVC pipe and fittings.

Don'ts

- Do not test with air or any compressed gas. Compressed air or gas testing may result in injury or death.
- Do not use to convey compressed air or any compressed gas. Conveying compressed air or gas may result in injury or death.
- Do not use solvent cement that exceeds its shelf life or has become discolored or gelled.
- Do not use solvent cement near sources of heat, open flame, or when smoking.
- Do not hydrostatically test until recommended cure times are met.
- Do not use dull or broken cutting tool blades when cutting pipe. At low temperatures a wheel type pipe cutter designed for plastic pipe is recommended.
- Do not use petroleum or solvent based paints, sealants, lubricants, or firestop materials.
- Do not use edible oils such as Crisco for lubricant.
- Do not restrict expansion or contraction.
- Do not install in cold weather without allowing for thermal expansion.
- Do not use tube straps that tend to over tighten or restrain the system.
- Do not use wood or plastic wedges that restrain the system.
- Do not bend CPVC tube transmitting mechanical stress to a fitting. Do not install fittings under stress.
- Do not terminate a pipe run against an immovable object (e.g. wall or floor joist).
- Do not allow heavy concentrations of termiticides to come into direct and sustained contact with CPVC pipe.
- Do not inject termiticides into the annular space between pipe wall and sleeving material.
- Do not spray termiticides, when preparing the slab, without first backfilling over underground piping.
- Do not exceed a maximum fluid flow velocity of 8-feet per second for CPVC CTS and 5-feet per second for CPVC Schedule 80.
- Do not exceed the maximum pressure rating of pipe, fittings, valves or flanges.
- Do not use an external heat source to bend CPVC.
- Do not exceed the max operating temperature or pressure of any system components.
- Do not connect CTS CPVC or Schedule 80 CPVC directly to a boiler.

Hydronic Heating Applications

NOTICE

Prior to installing PVC or CPVC piping in hydronic applications, it is important to flush the interior of the heat exchangers and the exterior of the condenser coils thoroughly with a mild ionic detergent solution to remove incompatible oils. Failing to do so could result in system failure and property damage.

Verify that all boiler cleaning and sealing chemicals used in hydronic radiant heating systems are compatible with PVC or CPVC. Failure to do so could result in system failure and property damage.

Equipment leaks in refrigeration or HVAC systems may release POE oils or other contaminants into the piping system. These oils and contaminants are incompatible with PVC or CPVC and such exposure may result in pipe or fitting failure regardless of flushing.

The table below highlights key points to remember when installing FlowGuard Gold® or Corzan® CPVC in a hydronic radiant heating application. A hydronic radiant heating application is defined here as piping directly off a water heater or boiler into a coil heating unit in single- or multi-family homes.

“DOs” for all hydronic applications

- Do install CPVC Schedule 80 domestic water systems using IPS P-70 or Oatey Industrial Grade primers.
- Do install CPVC Schedule 80 domestic water systems using IPS 714 or Oatey CPVC Heavy Duty Orange solvent cements.
- Install in accordance with both Charlotte Pipe and Foundry's and solvent cement manufacturer's recommendations and installation instructions.
- Follow recommended safe work practices.
- Verify that the maximum outlet temperature and pressure of the boiler is less than the temperature and pressure rating of the pipe (see charts below).
- Always use the proper derating factors with FlowGuard Gold and Corzan CPVC pipe to find the pressure rating at the applicable operating temperature.
- Always follow applicable codes and approvals when installing plumbing and heating equipment.
- Ensure that the system design allows for thermal expansion and contraction as recommended in the Charlotte Pipe and Foundry Plastics Technical Manual.

- Use only CPVC x brass threaded transition fittings when installing FlowGuard Gold systems.
- Use proper solvent cementing practices, including beveling and proper dauber sizing.
- Align all piping system components properly without strain. Do not bend or pull pipe into position after being solvent welded.
- Provide additional support to the brass side of a CPVC x brass transition or other metallic components to support the weight of the metal system.
- Use check valves, heat traps or back flow preventer to prevent cross-connections between hot and cold water lines.
- Flush the interior of heat exchangers or the exterior of condenser coils thoroughly with mild ionic detergent solution to remove incompatible oils prior to piping installation.
- Rinse with clean water to purge the system as a final flushing.
- Verify that all boiler cleaning and sealing chemicals used in the hydronic radiant heating system are compatible with CPVC.

“DON'Ts” for all hydronic applications

- Do not exceed the operating temperature or operating pressure of the piping system.
- Do not use CPVC male or female adapters with plastic molded threads for FlowGuard Gold systems.
- Do not use the CPVC piping system to support any metallic components.
- Do not use compression fittings for hydronic radiant heating applications.
- Do not use solvent cement that exceeds its shelf life, has become discolored or has gelled.
- Do not use CPVC tees or other CPVC components as hot and cold mixing devices.
- Do not apply excessive solvent-cement to the joints. Puddling of solvent cement must be avoided.
- Do not rely on an expansion tank to handle thermal expansion of the piping system. Expansion tanks accommodate expansion of the fluid, not longitudinal expansion of the pipe. The piping system must be designed to allow for thermal expansion.

NOTICE

Failure to compensate for expansion and contraction caused by temperature change may result in system failure and property damage.

- Do not restrict expansion or contraction. Restraining movement in piping systems is not recommended and may result in joint or fitting failure.
- Use straps or clamps that allow for piping system movement.
- Align all piping system components properly without strain. Do not bend or pull pipe into position after being solvent welded.
- Do not terminate a pipe run against a stationary object (example: wall or floor joist).
- Do not install fittings under stress.

NOTICE

Prior to installing PVC or CPVC piping in hydronic applications, it is important to flush the interior of the heat exchangers and the exterior of the condenser coils thoroughly with a mild ionic detergent solution to remove incompatible oils. Failing to do so could result in system failure and property damage.

Verify that all boiler cleaning and sealing chemicals used in hydronic radiant heating systems are compatible with PVC or CPVC. Failure to do so could result in system failure and property damage.

Equipment leaks in refrigeration or HVAC systems may release POE oils or other contaminants into the piping system. These oils and contaminants are incompatible with PVC or CPVC and such exposure may result in pipe or fitting failure regardless of flushing.

FlowGuard Gold® Pressure Rating Chart (psi)

Pipe Size	73°F	80°F	120°F	140°F	180°F
ALL (SDR-11)	400	328	260	200	100

Corzan® Schedule 80 Pressure Rating Chart (psi)

Pipe Size	73°F	80°F	120°F	140°F	180°F
2"	400	328	260	200	100
3"	370	303	241	185	93
4"	320	262	208	160	80
6"	280	230	182	140	70
8"	250	205	163	125	63

NOTICE

Use of FlowGuard Gold® CTS CPVC all-plastic threaded male adapters in hot water applications may result in system failure and property damage.

- Use plastic threaded CTS CPVC male adapters in cold water applications only.
- Use CTS CPVC x brass threaded transition fittings for hot water applications.
- Do not use compression fittings with brass ferrules to connect to CTS CPVC pipe or fittings where water temperatures will exceed 140 degrees F.
- CPVC pipe can be used with standard brass ferrules to make compression connections where the operating temperature will not exceed 140°F. Apply Teflon (PTFE) tape over the ferrule to allow for the dissimilar thermal expansion and contraction characteristics of the metal ferrule and the plastic pipe.

NOTICE

Do not exceed the maximum working pressure of any system components including pipe, fittings, valves, molded or cut threads, unions, mechanical coupling or flanges.

- The pressure rating of all components must be reduced at temperatures above 73 degrees F. Refer to de-rating table in this manual.
- Exceeding the maximum working temperature or pressure of the system may result in system failure and property damage.

Material Selection, Special System Design and Engineering Considerations

Selection of Materials For Sanitary and Storm Drainage

Engineers and designers today have a number of materials from which to choose as they design sanitary and storm drainage systems for residential and commercial projects. Due to its exceptional strength and combination of being non-combustible and extremely quiet, cast iron soil pipe is a very popular choice for commercial construction. Upscale homes often feature cast iron stacks combined with plastic used for lavs, showers and tubs for a system Charlotte Pipe calls a "Quiet House[®]" design. PVC and ABS DWV systems are allowed under all of the major national plumbing codes unless restricted by local or state amendment and are very popular as well.

Charlotte Pipe manufactures ABS cellular (foam) core pipe conforming to ASTM F 628 as well as PVC pipe in both solid wall and cellular core types. PVC solid wall meets the requirements of ASTM D 1785 and D 2665, and PVC cellular core pipe conforms to ASTM F 891. All of these plastic pipe systems are allowed for sanitary and storm drainage both above and below grade in the Uniform Plumbing Code (UPC), the International Plumbing Code (IPC), the National Standard Plumbing Code (NSPC) and most local or state variations thereof. None of these national model codes differentiate between residential or commercial uses of these plastic systems or otherwise restrict the use of any of these systems to any specific class of construction. All of the systems can be installed below grade, under slab and above grade in most areas except those classified as "return air plenums."

Solid wall pipe is just as the name implies: solid PVC material throughout the entire pipe wall. Cellular core pipe is manufactured using a unique co-extrusion process that produces pipe with a thin solid inner layer and outer layer with a foam core between these walls. Foam core pipe has the exact same dimensions as solid wall, yet is lighter and less expensive. Noise transmission is a function of density so while cast iron is by far the quietest material, PVC solid wall would be somewhat less noisy than either PVC or ABS cellular core pipe. While both are suitable for burial at most depths and common soil types, solid wall pipe is somewhat more "robust" and has a higher pipe stiffness, particularly in sizes 6" and smaller. Both ASTM F 628 and F 891 have the following limitation; Appendix X3, Installation, paragraph X3.1: maximum aggregate size shall be limited to 1/2 in. (13 mm) for angular and 3/4 in. (19 mm) for rounded

particles. This statement is significant as ASTM D 2321 allows aggregate and stone that pass through 1³/₂" sieve. PVC is classified as a flexible piping system, and as such it is dependant upon proper bedding and backfill for its ability to withstand Earth and live loads. Therefore, all plastic pipe must be installed below grade in accordance with ASTM D 2321. Cellular core pipe of any type is designed for drainage only, carries no pressure rating and Charlotte Pipe marks each piece with the print line "Not for Pressure." PVC solid wall pipe is "dual marked" and meets the ASTM standards for both pressure and drainage pipe.

Many designers allow the use of cellular core pipe on residential or light commercial projects and require the use of solid wall PVC or cast iron on commercial projects such as institutions, schools, restaurants, hospitals etc. Charlotte Pipe recommends that cellular core PVC pipe be installed in commercial applications with caution. Underground installations should be in strict conformance to ASTM D 2321. Ultimately the engineer, designer, developer or owner must evaluate the requirements of each project and specify the products they feel best suit their design criteria.

Engineered Applications

Over the past few years many new innovations have been introduced to the industry including siphonic roof drainage, solvent, air admittance devices and other products. Some of these products do not conform to existing standards or to the requirements of the model plumbing codes. Rather, they are designed into the system by engineers and approved as an alternate material within the code.

Charlotte Pipe and Foundry manufactures pipe and fitting systems that conform to published ASTM and Cast Iron Soil Pipe Institute standards. Products are warranted to conform to the requirements of applicable standards when used for the applications defined within these standards. Charlotte Pipe and Foundry will not accept liability for applications that do not conform to the standards to which we manufacture.

Unstable Soil

Burial of pipe under slab in soils that are unstable is often accomplished by suspending the piping systems from structural slabs. The use of plastic pipe in such installations must be in accordance with ASTM F 2536. Cellular core pipe is specifically not permitted for these applications.

Using Plastics in Multi-Story Construction

Incorporating plastic piping systems into multi-story construction raises special design considerations. Charlotte Pipe plastic pipe and fittings are warranted to conform to ASTM or other applicable product-based standard, not for any particular system design.

Products and materials selected for use in multi-story construction (four floors and up) must conform to all applicable building, plumbing and fire codes. Product selection and/or specification should be made by an architect, engineer, contractor, or other licensed professional. This must include specification of a code-compliant, chemically compatible firestop system with an appropriate service life, which must be properly installed and inspected for conformance to building, plumbing and fire codes by the responsible governmental authority.

In selecting products and material for multi-story construction, consideration should be given to Charlotte Pipe's cast iron soil pipe products, which are an excellent choice for many multi-story applications. Charlotte Pipe recommends noncombustible cast iron DWV piping systems in multi-story construction.

Using Plastics for Combustion Gas Venting

Charlotte Pipe recommends that inquiries about the suitability of plastic piping systems for venting combustion gases should be directed to the manufacturer of the water or space heating equipment being installed. As stated in the International Code Council's International Fuel Gas Code 503.4.1.1:

Plastic Pipe and fittings used to vent appliances shall be installed in accordance with the appliance manufacturer's installation instructions.

Furthermore, several of the ASTM standards applicable to plastic pipe and fittings that Charlotte Pipe manufactures include the following note: **This standard specification does not include requirements for pipe and fittings intended to be used to vent combustion gases.**

WARNING

Combustion Gas Venting

Failure to properly vent combustion gas may result in serious injury or death from carbon monoxide.

- Always install / use pipe or fittings as specified by the appliance manufacturer's installation instructions to vent appliances.

Repairs or Modifications to Existing CPVC CTS Systems

(Reprinted from FBC Plumbing Connections, Issue 29, 4Q 2009, written by Steve Manis, Technical Manager)

It's important to note that the chemical properties of all plastic pipe, including CPVC pipe, change over time. Visually, this means that the pipe may experience color variations. The temperature of the water running through the pipe often determines the degree of variation, with hot water causing a more noticeable change. Such color variations, however, do not indicate that the performance of the pipe has been compromised. The pressure bearing capabilities of CPVC pipe, in fact, actually increase as the pipe ages to help ensure a reliable, long-term performance.

What also changes over time is the impact resistance of the system. But since an installed system has little opportunity to sustain impact, this change has little to no effect. It does mean, however, that if a cut-in is necessary as a result of a modification to the line or the addition of a fixture, additional care should be taken to prevent the system from sustaining

impact. While it is acceptable to use a ratchet cutter when installing new pipe, its use can compress the pipe and cause end cracks on aged pipe. For this reason, a ratchet cutter should not be used on aged CPVC pipe. Even if the cracks are not visible, they can eventually propagate through the fitting and cause a leak.

I suggest using either a wheel-type cutter or fine-tooth saw when performing a cut-in procedure. Once the pipe is cut, continue with standard installation procedures, including beveling the pipe and solvent cementing the fitting. Keep in mind that if the area is wet as a result of water being inside the line, you need to add to the cure time typically required. In some cases, the required cure time may be three times as long. That's why it's valuable to try to dry the area as much as possible.

LIMITED WARRANTY

Charlotte Pipe and Foundry Company® (Charlotte Pipe®) Products are warranted to be free from manufacturing defects and to conform to currently applicable ASTM standards for a period of five (5) years from date of delivery. Buyer's remedy for breach of this warranty is limited to replacement of, or credit for, the defective product. This warranty excludes any expense for removal or reinstallation of any defective product and any other incidental, consequential, or punitive damages. **This limited warranty is the only warranty made by seller and is expressly in lieu of all other warranties, express and implied, including any warranties of merchantability and fitness for a particular purpose.** No statement, conduct or description by Charlotte Pipe or its representative, in addition to or beyond this Limited Warranty, shall constitute a warranty. This Limited Warranty may only be modified in writing signed by an officer of Charlotte Pipe.

This Limited Warranty will not apply if:

- 1) The Products are used for purposes other than their intended purpose as defined by local plumbing and building codes, and the applicable ASTM standard.
- 2) The Products are not installed in good and workmanlike manner consistent with normal industry standards; installed in compliance with the latest instructions published by Charlotte Pipe and good plumbing practices; and installed in conformance with all applicable plumbing, fire and building code requirements.
- 3) This limited warranty does not apply when the products of Charlotte Pipe are used with the products of other manufacturers that do not meet the applicable ASTM or CISPI standards or that are not marked in a manner to indicate the entity that manufactured them.
- 4) The Products fail due to defects or deficiencies in design, engineering, or installation of the piping system of which they are a part.
- 5) The Products have been the subject of modification; misuse; misapplication; improper maintenance or repair; damage caused by the fault or negligence of anyone other than Charlotte Pipe; or any other act or event beyond the control of Charlotte Pipe.
- 6) The Products fail due to the freezing of water in the Products.

- 7) The Products fail due to contact with chemical agents, fire stopping materials, thread sealant, plasticized vinyl products, or other aggressive chemical agents that are not compatible.
- 8) Pipe outlets, sound attenuation systems or other devices are permanently attached to the surface of Charlotte® PVC, ABS or CPVC products with solvent cement or adhesive glue.

Charlotte Pipe products are manufactured to the applicable ASTM or CISPI standard. Charlotte Pipe and Foundry **cannot** accept responsibility for the performance, dimensional accuracy, or compatibility of pipe, fittings, gaskets, or couplings not manufactured or sold by Charlotte Pipe and Foundry.

Any Charlotte Pipe products alleged to be defective **must** be made available to Charlotte Pipe at the following address for verification, inspection and determination of cause:

Charlotte Pipe and Foundry Company
Attention: Technical Services
2109 Randolph Road
Charlotte, North Carolina 28207

Purchaser must obtain a return materials authorization and instructions for return shipment to Charlotte Pipe of any product claimed defective or shipped in error.

Any Charlotte Pipe product **proved** to be defective in manufacture will be replaced F.O.B. point of original delivery, or credit will be issued, at the discretion of Charlotte Pipe.

4/15/10

! WARNING

Testing with or use of compressed air or gas in PVC / ABS / CPVC / Cast Iron pipe or fittings can result in explosive failures and cause severe injury or death.

AIR/GAS



- NEVER test with or transport/store compressed air or gas in PVC / ABS / CPVC / Cast Iron pipe or fittings.
- NEVER test PVC / ABS / CPVC / Cast Iron pipe or fittings with compressed air or gas, or air over water boosters.
- ONLY use PVC / ABS / CPVC / Cast Iron pipe for water or approved chemicals.
- Refer to warnings in PPFA User Bulletin 4-80 and ASTM D 1785.

Charlotte and Charlotte Pipe are registered trademarks of Charlotte Pipe and Foundry Company.

PO Box 35430 Charlotte, NC 28235 USA 704/348-6450 800/572-4199 FAX 800/553-1605
www.charlottepipe.com

FLOWGUARD GOLD® CPVC CTS LIMITED WARRANTY

Charlotte Pipe and Foundry Company (Charlotte Pipe®) warrants to the original owner of the structure in which its FlowGuard Gold CTS CPVC Pipe and Fittings (the "Products") have been installed, that the Products will be free from manufacturing defects and conform to currently applicable ASTM standards under normal use and service for a period of ten (10) years. Buyer's remedy for breach of this warranty is limited to replacement of, or credit for, the defective product. This warranty excludes any expense for removal or reinstallation of any defective product and any other incidental, consequential, or punitive damages. **This limited warranty is the only warranty made by seller and is expressly in lieu of all other warranties, express and implied, including any warranties of merchantability and fitness for a particular purpose.** No statement, conduct or description by Charlotte Pipe or its representative, in addition to or beyond this Limited Warranty, shall constitute a warranty. This Limited Warranty may only be modified in writing signed by an officer of Charlotte Pipe.

This Limited Warranty will not apply if:

- 1) The Products are used for purposes other than the transmission of domestic water.
- 2) The Products are not installed in good and workmanlike manner consistent with normal industry standards; installed in compliance with the latest instructions published by Charlotte Pipe and good plumbing practices; and installed in conformance with all applicable plumbing, fire and building code requirements.
- 3) This limited warranty does not apply when the products of Charlotte Pipe are used with the products of other manufacturers that do not meet the ASTM standard or that are not marked in a manner to indicate the entity that manufactured them.
- 4) The Products fail due to defects or deficiencies in design, engineering, or installation of the water distribution system of which they are a part.
- 5) The Products have been the subject of modification; misuse; misapplication; improper maintenance or repair; damage caused by the fault or negligence of anyone other than Charlotte Pipe; or any other act or event beyond the control of Charlotte Pipe.
- 6) The Products fail due to the freezing of water in the Products.
- 7) The Products fail due to contact with chemical agents, fire stopping materials, thread sealant, plasticized vinyl products, or other aggressive chemical agents not compatible with CPVC compounds.

Charlotte Pipe products are manufactured to the applicable ASTM standard. Charlotte Pipe and Foundry **cannot** accept responsibility for the performance, dimensional accuracy, or compatibility of pipe, fittings, gaskets, or couplings not manufactured or sold by Charlotte Pipe and Foundry.

Any Charlotte Pipe products alleged to be defective **must** be made available to Charlotte Pipe at the following address for verification, inspection and determination of cause:

Charlotte Pipe and Foundry Company
Attention: Technical Services
2109 Randolph Road
Charlotte, North Carolina 28207

Purchaser must obtain a return materials authorization and instructions for return shipment to Charlotte Pipe of any product claimed defective or shipped in error.

Any Charlotte Pipe product **proved** to be defective in manufacture will be replaced F.O.B. point of original delivery, or credit will be issued, at the discretion of Charlotte Pipe.

3/25/10

⚠ WARNING

Testing with or use of compressed air or gas in PVC / ABS / CPVC pipe or fittings can result in explosive failures and cause severe injury or death.

AIR/GAS



- NEVER test with or transport/store compressed air or gas in PVC / ABS / CPVC pipe or fittings.
- NEVER test PVC / ABS / CPVC pipe or fittings with compressed air or gas, or air over water boosters.
- ONLY use PVC / ABS / CPVC pipe for water or approved chemicals.
- Refer to warnings in PPFA User Bulletin 4-80 and ASTM D 1785.

Charlotte Pipe is a registered trademark of Charlotte Pipe and Foundry Company.
FlowGuard Gold is a registered trademark of The Lubrizol Corporation.

CHARLOTTE

PIPE AND FOUNDRY COMPANY®

PO BOX 35430

CHARLOTTE

NORTH CAROLINA 28235

PHONE (704) 348-6450

(800) 438-6091

FAX (800) 553-1605

LITERATURE BY FAX (800) 745-9382

WWW.CHARLOTTEPIPE.COM

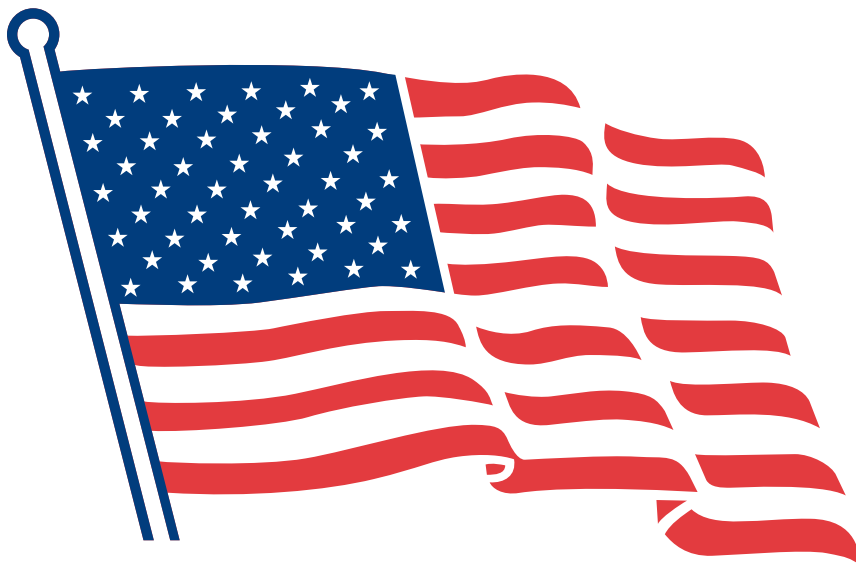

All products manufactured by
Charlotte Pipe and Foundry Company
are proudly made in the U.S.A.

