

You can't beat the system.®

# Plastics

TECHNICAL AND INSTALLATION MANUAL

(Updated November 2008)



Monroe, North Carolina



Muncy, Pennsylvania



Cameron, Texas



Wildwood, Florida

Charlotte Pipe® has been relentless in our commitment to quality and service for more than a century. Through the years we have broadened and enhanced our product lines to better serve our customers. As the leading full-line manufacturer of PVC, CPVC, and ABS piping systems for drainage and pressure applications, we welcome the opportunity to be the one-stop source for all your thermoplastic piping systems. Charlotte® is the only company that manufactures pipe and fittings to exacting TrueFit tolerances. Our systems are designed to fit together precisely for easier installation, fewer callbacks and a lifetime of trouble-free service - the major benefits of a Charlotte Pipe TrueFit® system.

**You can't beat the system.®**



Huntsville, Alabama



Cedar City, Utah

## Manufacturing Facilities

- Monroe, North Carolina
- Muncy, Pennsylvania
- Cameron, Texas
- Wildwood, Florida
- Huntsville, Alabama
- Cedar City, Utah

**CHARLOTTE**  
**PIPE AND FOUNDRY COMPANY**

P.O. Box 35430 • Charlotte, North Carolina 28235  
704/348-6450 • 800/438-6091 • FAX 800/553-1605  
[www.charlottepipe.com](http://www.charlottepipe.com)

# TABLE OF CONTENTS

<b>GENERAL INFORMATION</b>	<b>Page</b>
<b>Introduction</b> .....	2
<b>Major Advantages of ABS, PVC and CPVC Pipe</b> .....	4
<b>Handling and Storage of ABS, PVC and CPVC Pipe</b> .....	5
<b>Physical Properties of ABS and PVC Materials</b> .....	6
<b>ABS and PVC Standards</b> .....	6
<b>Physical Properties of CPVC Materials</b> .....	7
<b>CPVC Standards</b> .....	7
<b>Recommended Product Specifications</b> .....	8-18
ABS Cellular Core (Foam Core) Pipe and ABS DWV Fitting System .....	8
PVC Schedule 40 Solid Wall Pipe and PVC DWV Fitting System .....	9
PVC Cellular Core (Foam Core) Pipe and PVC DWV Fitting System .....	10
PVC Schedule 40 Pressure Pipe and Fitting System .....	11
PVC SDR Pressure Pipe and Fitting System .....	12
PVC Schedule 80 Pressure Pipe and Fitting System .....	13
CPVC Schedule 80 Corzan® Pressure Pipe and Fitting System .....	14
PVC SDR 35 Gravity Sewer Pipe .....	15
PVC Cellular Core (Foam Core) Sewer Pipe PS 50/ Sewer and Drain Series .....	16
<b>Product Certification</b> .....	17
<b>Pipe Reference Guide</b> .....	18
<b>Pipe Data (Dimensions, Weight and Pressure Ratings)</b> .....	19-29
<b>Socket Dimensions for Belled-End Pipe</b> .....	26
<b>DESIGN AND ENGINEERING DATA</b>	
<b>Pressure/Temperature Relationship</b> .....	30
Low Temperature Recommendations .....	30
<b>Fluid Flow Properties</b> .....	31-35
Gravity Flow and Fluid Flow Rate .....	31
Pressure Flow Rate .....	32
Friction Loss Through Fittings .....	32
Water Hammer / Entrapped Air .....	33-35
Weathering UV Exposure .....	35
Friction Loss and Flow Velocity Table .....	36-40
<b>Support Spacing for ABS, PVC and CPVC Pipe</b> .....	41-42
<b>Typical Pipe Hangers, Clamps, and Supports</b> .....	42
<b>Expansion and Contraction of ABS, PVC and CPVC</b> .....	43
<b>Underground Installation</b> .....	44
<b>Installation Procedures</b> .....	45-46
<b>Joint Curing</b> .....	47
<b>Testing Pressure System</b> .....	47
<b>Flanges and Unions PVC and CPVC Pipe</b> .....	48
<b>Threaded Joints and Threading of PVC and CPVC Pipe</b> .....	49-50
<b>Antifreeze Solutions</b> .....	51
<b>Joining Roll-Grooved Pipe</b> .....	51
<b>Testing DWV and Inspection</b> .....	52
<b>Hydronic Heating Applications</b> .....	53
<b>Material Selection</b> .....	54
<b>Engineered Applications</b> .....	54
<b>Unstable Soil</b> .....	54
<b>Venting Combustion Gases</b> .....	54
<b>CHEMICAL RESISTANCE CHART OF ABS, PVC AND CPVC</b> .....	55-70
<b>QUICK REFERENCE FACT SHEETS</b> .....	71-85
<b>CONVERSION CHARTS</b> .....	86-87
<b>LIMITED WARRANTY</b> .....	88
<b>HELPFUL REFERENCE STANDARDS</b> .....	89-92



# MAJOR ADVANTAGES OF ABS, PVC AND CPVC PIPE

## Product Advantage

- While ABS, PVC and CPVC are very different materials, they share numerous advantages common to plastic piping systems. Advantages include ease of installation, corrosion resistance, low friction loss, initial cost, and longevity.

### Easy Installation

- ABS, PVC and CPVC systems are light in weight (approximately one-half the weight of aluminum and one-sixth the weight of steel) reducing transportation, handling, and installation cost. They have smooth, seamless interior walls. No special tools are required for cutting. These materials can be installed using the solvent cementing joining technique.

### Strength

- ABS, PVC and CPVC products are highly resilient, tough and durable with high tensile and high impact strength.

### Freedom from Toxicity, Odors, Tastes

- PVC and CPVC piping are non-toxic, odorless, and tasteless. They have been listed by the National Sanitation Foundation for use with potable water.

### Corrosion Free External and Internal

- With many other pipe materials, slight corrosion may occur. The corroded particles can contaminate the piped fluid, complicating further processing, or causing bad taste, odors, or discoloration. This is particularly undesirable when the piped fluid is for domestic consumption. With PVC and CPVC, there are no corrosive by-products, therefore, no contamination of the piped fluid.

### Immunity to Galvanic or Electrolytic Attack

- ABS, PVC and CPVC are inherently immune to galvanic or electrolytic action. They can be used underground, underwater, in the presence of metals, and can be connected to metals.

### Fire Resistance

- PVC and CPVC piping systems are self extinguishing and will not support combustion. The ASTM E 84 test protocol is used to determine the flame and smoke rating for various materials.
- PVC will not pass the ASTM E-84 25/50 flame spread / smoke developed test and is not acceptable for use in plenum areas.
- Consult Charlotte Pipe for additional information on CPVC in plenum applications.
- For plenum applications, follow prevailing code requirements.

### Low Friction Loss

- The smooth interior surfaces of ABS, PVC and CPVC assure low friction loss and high flow rate. Additionally, since ABS, PVC and CPVC pipe will not rust, pit, scale, or corrode, the high flow rate will be maintained for the life of the piping system.

### Low Thermal Conductivity

- PVC and CPVC pipe have a much lower thermal conductivity factor than metal pipe. Therefore, fluids being piped maintain a more constant temperature. In most cases, pipe insulation is not required.

### Cost Effective

- ABS, PVC and CPVC products are extremely light weight, convenient to handle, relatively flexible, and easy to install. These features lead to lower installed cost than other piping systems.

### Maintenance Free

- Once an ABS, PVC or CPVC system is properly selected, designed, and installed, it is virtually maintenance free. It will not rust, pit, scale, corrode, or promote build-up on the interior. Therefore, years of trouble-free service can be expected when using Charlotte Pipe and Foundry ABS, PVC and CPVC systems.

## DO NOT USE CHARLOTTE PIPE PRODUCTS FOR COMPRESSED AIR OR GASES

Charlotte Pipe and Foundry Company products are not intended to be used for distribution or storage of compressed air or gases. Use of Charlotte Pipe products in inappropriate applications could result in product failure, serious injury or death.

## Air or Gas Testing - Not Recommended

Air or compressed gas test are sometimes performed instead of hydrostatic (water) test. **DANGER:** Charlotte Pipe and Foundry Company **does not** recommend air or gas testing, consistent with PPFA User Bulletin 4-80 and / or ASTM D 1785. **Pipe and fitting materials under air or gas pressure can explode, causing serious injury or death.** Charlotte Pipe will not be responsible or liable for injury or death to persons or damage to property or for claims for labor and / or material arising from any alleged failure of our products during testing with air or compressed gasses.

# HANDLING AND STORAGE OF ABS, PVC AND CPVC PIPE

**CHARLOTTE**  
PIPE AND FOUNDRY COMPANY®

## Receiving Pipe:

As pipe is received, it must always be thoroughly inspected, prior to unloading. The person receiving the pipe must look for any transportation damage caused by over-tightened tie-down straps, improper treatment, or a shift in the load.

Pipe received in a closed trailer must be inspected as the trailer is opened. Take extra time to ensure that the pipe has not been damaged by other materials having been stacked on top of it, load shift, or rough handling.

Visually examine the pipe ends for any cracks, splits, gouges, or other forms of damage. Additionally, the pipe should be inspected for severe deformation which could later cause joining problems. The entire inside diameter of larger diameter pipe (4" and above) must be checked for any internal splits or cracks which could have been caused by loading or transit. The use of a flashlight may be necessary to perform this inspection.

Any damages must be observed by all parties involved, including the driver, and should be clearly noted on the bill of lading and/or delivery ticket. A copy of this document should be retained by the receiver. In addition, the manufacturer and carrier should be notified, within 24 hours, of any damages, shortages, or mis-shipped products.

## Handling Pipe:

The pipe should be handled with reasonable care. Because thermoplastic pipe is much lighter in weight than metal pipe, there is sometimes a tendency to throw it around. This should be avoided.

The pipe should never be dragged or pushed from a truck bed. Removing and handling pallets of pipe should be done with a forklift. Loose pipe lengths require special handling to avoid damage. Precautions to follow when unloading and handling loose pieces include not banging lengths together or dropping lengths, even from low heights, on hard or uneven surfaces.



In all cases, severe contact with any sharp objects (rocks, angle irons, forks on forklifts, etc.) should be avoided. Also, the pipe should never be lifted or moved by inserting the forks of a forklift into the pipe ends.

Handling PVC and particularly CPVC pipe diameters greater than 4-inch requires extra care as the added pipe weight can cause cracking from relatively minor impacts. Also, plastic pipe becomes more brittle as the temperature decreases. The impact strength and flexibility of PVC and especially CPVC pipe are reduced. Therefore, take extra care when handling skids or loose lengths when the temperature drops below 50° F.

## Storing Pipe:

If possible, pipe should be stored inside. When this is not possible, the pipe should be stored on level ground which is dry and free from sharp objects. If different schedules of pipe are stacked together, the pipe with the thickest walls should be on the bottom.

If the pipe is in pallets, the pallets should be stacked with the pallet boards touching, rather than pallet boards being placed on the pipe. This will prevent damage to or bowing of the pipe.

If the pipe is stored in racks, it should be continuously supported along its length. If this is not possible, the spacing of the supports should not exceed three feet (3').

The pipe should be protected from the sun and be in an area with proper ventilation. This will lessen the effects of ultraviolet rays and help prevent heat build-up.

# PHYSICAL PROPERTIES OF ABS AND PVC MATERIALS

PROPERTY	UNITS	ABS	ASTM NO.	PVC	ASTM NO.
Specific Gravity	g/cc	1.05	D 792	1.40	D 792
Tensile Strength (73°F) Minimum	Psi	4,500	D 638	7,000	D 638
Modulus of Elasticity in Tension (73°F) Minimum	Psi	240,000	D 638	400,000	D 638
Flexural Strength (73°F)	Psi	10,585	D 790	14,000	D 790
Izod Impact (notched at 73°F) Minimum	ft lb/ in.	6.00	D 256	0.65	D 256
Hardness (Durometer D)		70	D 2240	80 ± 3	D 2240
Hardness (Rockwell R)		100	D 785	110 - 120	D 785
Compressive Strength (73°F)	Psi	7,000	D 695	9,600	D 695
Hydrostatic Design Stress	Psi	N/A		2,000	D 1598
Coefficient of Linear Expansion	in./ in./ °F	5.5 x 10 <sup>-5</sup>	D 696	3.0 x 10 <sup>-5</sup>	D 696
Heat Distortion Temperature at 264 psi Minimum	degrees F	180	D 648	160	D 648
Coefficient of Thermal Conductivity	BTU/ hr/sq ft/ °F/ in.	1.1	C 177	1.2	C 177
Specific Heat	BTU/ °F/lb	0.35	D 2766	0.25	D 2766
Water Absorption (24 hrs at 73°F)	% weight gain	0.40	D 570	.05	D 570
Cell Classification - Pipe		42222	D 3965	12454	D 1784
Cell Classification - Fittings		32222	D 3965	12454	D 1784
Burning Rate				Self Ext.	D 635
Burning Class				V-0	UL 94*

Above data is based upon information provided by the raw material manufacturers. It should be used only as a recommendation and not as a guarantee of performance. \* Underwriters Laboratories standard

## ABS and PVC Standards

TYPE PIPE / FITTING	STANDARD SPECIFICATIONS	
	MATERIAL	DIMENSIONS
<b>ABS DWV</b>		
Schedule 40 DWV Foam Core Pipe	ASTM D 3965	ASTM F 628
Schedule 40 DWV Fittings	ASTM D 3965	ASTM D 2661
<b>PVC DWV</b>		
Schedule 40 DWV Pipe	ASTM D 1784	ASTM D 2665 & ASTM D 1785
Schedule 40 DWV Foam Core Pipe	ASTM D 4396	ASTM F 891
Schedule 40 DWV Fittings	ASTM D 1784	ASTM D 2665
<b>PVC Pressure</b>		
Schedule 40 Plain End Pipe	ASTM D 1784	ASTM D 1785
Schedule 40 Bell End Pipe	ASTM D 1784	ASTM D 1785
Schedule 40 Bell End Well Casing	ASTM D 1784	ASTM D 1785 & ASTM F 480
SDR 21 (PR 200) Bell End Pipe	ASTM D 1784	ASTM D 2241
SDR 26 (PR 160) Bell End Pipe	ASTM D 1784	ASTM D 2241
Schedule 40 Fittings	ASTM D 1784	ASTM D 2466
Schedule 80 Plain End Pipe	ASTM D 1784	ASTM D 1785
Schedule 80 Fittings	ASTM D 1784	ASTM D 2464 & ASTM D 2467

# PHYSICAL PROPERTIES OF CORZAN CPVC MATERIALS

PROPERTY	CPVC 4120	UNITS	ASTM No.
Specific Gravity	1.55	g/cc	D 792
Tensile Strength (73°F) Minimum	7,000	psi	D 638
Modulus of Elasticity in Tension (73°F)	360,000	psi	D 638
Flexural Strength (73°F)	15,100	psi	D 790
Izod Impact Cell Class 23447 (notched at 73°F) Minimum	1.5	ft lb/ in. of notch	D 256
Izod Impact Cell Class 24448 (notched at 73°F) Minimum	5.0	ft lb/ in. of notch	D 256
Hardness (Durometer D)	—		D 2240
Hardness (Rockwell R)	119		D 785
Compressive Strength (73°F)	10,100	psi	D 695
Hydrostatic Design Stress	2,000	psi	
Coefficient of Linear Expansion	3.4 x 10 <sup>-5</sup>	in./ in./ °F	D 696
Heat Distortion Temperature at 264 psi Minimum	212 (Cell Class 23447)	degrees F	D 648
Heat Distortion Temperature at 264 psi Minimum	230 (Cell Class 24448)	degrees F	D 648
Coefficient of Thermal Conductivity	.95	BTU/ hr/sq ft/ °F/ in.	C 177
Specific Heat	—	cal/ °C/ gm	D 2766
Water Absorption (24 hrs at 73°F)	.03	% weight gain	D 570
Cell Classification	23447 - 24448		D 1784
Burning Rate	Self Extinguishing		D 635
Burning Class	V-0		UL 94*

Above data is based upon information provided by the raw material manufacturers. It should be used only as a recommendation and not as a guarantee of performance. \* Underwriters Laboratories standard

## CPVC Standards

TYPE PIPE / FITTINGS	STANDARD SPECIFICATIONS	
	MATERIAL	DIMENSIONS
<b>CPVC Pressure</b>		
CPVC Schedule 80 Plain End Pipe	ASTM D 1784	ASTM F 441
CPVC Schedule 80 Fittings	ASTM D 1784	ASTM F 437 and ASTM F 439

# RECOMMENDED PRODUCT SPECIFICATION

## Suggested Specification

**System:** **ABS Cellular Core (Foam Core) Pipe and ABS DWV Fitting System**

**Scope:** This specification covers ABS cellular core (foam core) pipe and ABS DWV fittings used in sanitary drain, waste, and vent (DWV), sewer, and storm drainage applications. This system is intended for use in non-pressure applications where the operating temperature will not exceed 160°F.

**Specification:** Pipe shall be manufactured from virgin rigid ABS (acrylonitrile-butadiene-styrene) compounds with a Cell Class of 42222 as identified in ASTM D 3965. Fittings shall be manufactured from virgin rigid ABS compounds with a Cell Class of 32222 as identified in ASTM D 3965.

ABS cellular core pipe shall be Iron Pipe Size (IPS) conforming to ASTM F 628. ABS DWV fittings shall conform to ASTM D 2661. Pipe and fittings shall be manufactured as a system and be the product of one manufacturer. All pipe and fittings shall be manufactured in the United States. All systems shall utilize a separate waste and vent system. Pipe and fittings shall conform to National Sanitation Foundation Standard 14.

Installation shall comply with the latest installation instructions published by Charlotte Pipe and Foundry and shall conform to all local plumbing, fire, and building code requirements. Buried pipe shall be installed in accordance with ASTM D 2321 and ASTM F 1668. Solvent cement joints shall be made with a solvent cement conforming to ASTM D 2235. The system shall be protected from chemical agents, fire stopping materials, thread sealant, or other aggressive chemical agents not compatible with ABS compounds. Systems shall be hydrostatically tested after installation. Testing with compressed air or gas is not recommended. **Testing with compressed air or gas may result in injury or death.**

### Referenced Standards:

ASTM D 3965	Rigid ABS Compounds
ASTM F 628	Co-extruded ABS Pipe with Cellular Core
ASTM D 2661	ABS Drain, Waste, and Vent Fittings
ASTM D 2235	Solvent Cements for ABS Pipe and Fittings
ASTM D 2321	Underground Installation of Thermoplastic Pipe (non-pressure applications)
ASTM F 1668	Procedures for Buried Plastic Pipe
NSF Standard 14	Plastic Piping Components and Related Materials

Note: Latest revision of each standard applies.

### Short Specification:

Pipe and fittings shall be manufactured from ABS compound with a cell class of 42222 for pipe and 32222 for fittings as per ASTM D 3965 and conform with National Sanitation Foundation (NSF) standard 14. Pipe shall be iron pipe size (IPS) conforming to ASTM F 628. Fittings shall conform to ASTM D 2661.

All pipe and fittings to be produced by a single manufacturer and to be installed in accordance with manufacturer's recommendations and local code requirements. Buried pipe shall be installed in accordance with ASTM D 2321 and ASTM F 1668. Solvent cement shall conform to ASTM D 2235. The system to be manufactured by Charlotte Pipe and Foundry Company and is intended for non-pressure drainage applications where the temperature will not exceed 160°F.



# RECOMMENDED PRODUCT SPECIFICATION

## Suggested Specification

**System:** PVC Schedule 40 Solid Wall Pipe and PVC DWV Fitting System

**Scope:** This specification covers PVC Schedule 40 solid wall pipe and PVC DWV fittings used in sanitary drain, waste, and vent (DWV), sewer, and storm drainage applications. This system is intended for use in non-pressure applications where the operating temperature will not exceed 140°F.

**Specification:** Pipe and fittings shall be manufactured from virgin rigid PVC (polyvinyl chloride) vinyl compounds with a Cell Class of 12454 as identified in ASTM D 1784.

PVC Schedule 40 pipe shall be Iron Pipe Size (IPS) conforming to ASTM D 1785 and ASTM D 2665. PVC DWV fittings shall conform to ASTM D 2665. Pipe and fittings shall be manufactured as a system and be the product of one manufacturer. All pipe and fittings shall be manufactured in the United States. All systems shall utilize a separate waste and vent system. Pipe and fittings shall conform to National Sanitation Foundation Standard 14.

Installation shall comply with the latest installation instructions published by Charlotte Pipe and Foundry and shall conform to all local plumbing, building, and fire code requirements. Buried pipe shall be installed in accordance with ASTM D 2321 and ASTM F 1668. Solvent cement joints shall be made in a two step process with primer manufactured for thermoplastic piping systems and solvent cement conforming to ASTM D 2564. The system shall be protected from chemical agents, fire stopping materials, thread sealant, plasticized vinyl products, or other aggressive chemical agents not compatible with PVC compounds. Systems shall be hydrostatically tested after installation. Testing with compressed air or gas is not recommended. **Testing with compressed air or gas may result in injury or death.**

### Referenced Standards:

ASTM D 1784	Rigid Vinyl Compounds
ASTM D 1785	PVC Plastic Pipe, Schedule 40
ASTM D 2665	PVC Drain, Waste, and Vent Pipe & Fittings
ASTM D 2564	Solvent Cements for PVC Pipe and Fittings
ASTM D 2321	Underground Installation of Thermoplastic Pipe (non-pressure applications)
ASTM F 1668	Procedures for Buried Plastic Pipe
NSF Standard 14	Plastic Piping Components and Related Materials

Note: Latest revision of each standard applies.

### Short Specification:

Pipe and fittings shall be manufactured from PVC compound with a cell class of 12454 per ASTM D 1784 and conform with National Sanitation Foundation (NSF) standard 14. Pipe shall be iron pipe size (IPS) conforming to ASTM D 1785 and ASTM D 2665. Fittings shall conform to ASTM D 2665.

All pipe and fittings to be produced by a single manufacturer and to be installed in accordance with manufacturer's recommendations and local code requirements. Buried pipe shall be installed in accordance with ASTM D 2321 and ASTM F 1668. Solvent cements shall conform to ASTM D 2564, primer shall conform to ASTM F 656. The system to be manufactured by Charlotte Pipe and Foundry Company and is intended for non-pressure drainage applications where the temperature will not exceed 140°F.

# RECOMMENDED PRODUCT SPECIFICATION

## Suggested Specification

**System:** PVC Cellular Core (Foam Core) Pipe and PVC DWV Fitting System

**Scope:** This specification covers PVC cellular core (foam core) pipe and PVC DWV fittings used in sanitary drain, waste, and vent (DWV), sewer, and storm drainage applications. This system is intended for use in non-pressure applications where the operating temperature will not exceed 140°F.

**Specification:** Pipe shall be manufactured from virgin rigid PVC (polyvinyl chloride) vinyl compounds with a Cell Class of 11432 as identified in ASTM D 4396. Fittings shall be manufactured from virgin rigid PVC (polyvinyl chloride) vinyl compounds with a Cell Class of 12454 as identified in ASTM D 1784.

PVC cellular core pipe shall be Iron Pipe Size (IPS) conforming to ASTM F 891. PVC DWV fittings shall conform to ASTM D 2665. Pipe and fittings shall be manufactured as a system and be the product of one manufacturer. All pipe and fittings shall be manufactured in the United States. All systems shall utilize a separate waste and vent system. Pipe and fittings shall conform to National Sanitation Foundation Standard 14.

Installation shall comply with the latest installation instructions published by Charlotte Pipe and Foundry and shall conform to all local plumbing, fire, and building code requirements. Buried pipe shall be installed in accordance with ASTM D 2321 and ASTM F 1668. Solvent cement joints shall be made in a two step process with primer manufactured for thermoplastic piping systems and solvent cement conforming to ASTM D 2564. The system shall be protected from chemical agents, fire stopping materials, thread sealant, plasticized vinyl products, or other aggressive chemical agents not compatible with PVC compounds. Systems shall be hydrostatically tested after installation. Testing with compressed air or gas is not recommended. **Testing with compressed air or gas may result in injury or death.**

### Referenced Standards:

ASTM D 4396	Compounds for Cellular Core Pipe
ASTM F 891	Co-extruded PVC Pipe with Cellular Core
ASTM D 2665	PVC Drain, Waste, and Vent Fittings
ASTM D 2564	Solvent Cements for PVC Pipe and Fittings
ASTM D 2321	Underground Installation of Thermoplastic Pipe (non-pressure applications)
ASTM F 1668	Procedures for Buried Plastic Pipe
NSF Standard 14	Plastic Piping Components and Related Materials

Note: Latest revision of each standard applies.

### Short Specification:

Pipe shall be manufactured from PVC compound with a cell class of 11432 per ASTM D 4396 and 12454 per ASTM D 1784 for fittings and conform with National Sanitation Foundation (NSF) standard 14. Pipe shall be iron pipe size (IPS) conforming to ASTM F 891. Fittings shall conform to ASTM D 2665.

All pipe and fittings to be produced by a single manufacturer and to be installed in accordance with manufacturer's recommendations and local code requirements. Buried pipe shall be installed in accordance with ASTM D 2321 and ASTM F 1668. Solvent cements shall conform to ASTM D 2564, primer shall conform to ASTM F 656. The system to be manufactured by Charlotte Pipe and Foundry Company and is intended for non-pressure drainage applications where the temperature will not exceed 140°F.

# RECOMMENDED PRODUCT SPECIFICATION

## Suggested Specification

**System:** PVC Schedule 40 Pressure Pipe and Fitting System

**Scope:** This specification covers PVC Schedule 40 pipe and fittings for pressure applications. This system is intended for pressure applications where the operating temperature will not exceed 140°F.

**Specification:** Pipe and fittings shall be manufactured from virgin rigid PVC (polyvinyl chloride) vinyl compounds with a Cell Class of 12454 as identified in ASTM D 1784.

PVC Schedule 40 pipe shall be Iron Pipe Size (IPS) conforming to ASTM D 1785. PVC Schedule 40 fittings shall conform to ASTM D 2466. Pipe and fittings shall be manufactured as a system and be the product of one manufacturer. All pipe and fittings shall be manufactured in the United States. Pipe and fittings shall conform to National Sanitation Foundation (NSF) Standard 61 or the health effects portion of NSF Standard 14.

Installation shall comply with the latest installation instructions published by Charlotte Pipe and Foundry and shall conform to all local plumbing, building, and fire code requirements. Buried pipe shall be installed in accordance with ASTM F 1668. Solvent cement joints shall be made in a two step process with primer manufactured for thermoplastic piping systems and solvent cement conforming to ASTM D 2564. The system shall be protected from chemical agents, fire stopping materials, thread sealant, plasticized vinyl products, or other aggressive chemical agents not compatible with PVC compounds. Systems shall be hydrostatically tested after installation. Testing with compressed air or gas is not recommended. **Testing with compressed air or gas may result in injury or death.**

### Referenced Standards:

ASTM D 1784	Rigid Vinyl Compounds
ASTM D 1785	PVC Plastic Pipe, Schedule 40
ASTM D 2466	PVC Plastic Fittings, Schedule 40
ASTM D 2564	Solvent Cements for PVC Pipe and Fittings
ASTM F 1668	Procedures for Buried Plastic Pipe
NSF Standard 14	Plastic Piping Components and Related Materials
NSF Standard 61	Drinking Water System Components - Health Effects

Note: Latest revision of each standard applies.

### Short Specification:

Pipe and fittings shall be manufactured from PVC compound with a cell class of 12454 per ASTM D 1784 and conform with National Sanitation Foundation (NSF) standards 14 and 61. Pipe shall be iron pipe size (IPS) conforming to ASTM D 1785. Fittings shall conform to ASTM D 2466.

All pipe and fittings to be produced by a single manufacturer and to be installed in accordance with manufacturer's recommendations and local code requirements. Buried pipe shall be installed in accordance with ASTM F 1668. Solvent cements shall conform to ASTM D 2564, primer shall conform to ASTM F 656. The system to be manufactured by Charlotte Pipe and Foundry Company and is intended for pressure applications where the temperature will not exceed 140°F.

# RECOMMENDED PRODUCT SPECIFICATION

## Suggested Specification

**System:** PVC SDR Pressure Pipe and Fitting System

**Scope:** This specification covers PVC Standard Dimensional Ratio (SDR) pipe and fittings for pressure applications. This system is intended for pressure applications where the operating temperature will not exceed 140°F.

**Specification:** Pipe and fittings shall be manufactured from virgin rigid PVC (polyvinyl chloride) vinyl compounds with a Cell Class of 12454 as identified in ASTM D 1784.

PVC SDR pipe shall be Iron Pipe Size (IPS) conforming to ASTM D 2241 for plain end pipe and ASTM D 2672 for belled-end pipe. PVC Schedule 40 (IPS) fittings shall conform to ASTM D 2466. Pipe and fittings shall be manufactured as a system and be the product of one manufacturer. All pipe and fittings shall be manufactured in the United States. Pipe and fittings shall conform to National Sanitation Foundation (NSF) Standard 61 or the health effects portion of NSF Standard 14.

Installation shall comply with the latest installation instructions published by Charlotte Pipe and Foundry and shall conform to all local plumbing, building, and fire code requirements. Buried pipe shall be installed in accordance with ASTM F 1668. Solvent cement joints shall be made in a two step process with primer manufactured for thermoplastic piping systems and solvent cement conforming to ASTM D 2564. The system shall be protected from chemical agents, fire stopping materials, thread sealant, plasticized vinyl products, or other aggressive chemical agents not compatible with PVC compounds. Systems shall be hydrostatically tested after installation. Testing with compressed air or gas is not recommended. **Testing with compressed air or gas may result in injury or death.**

### Referenced Standards:

ASTM D 1784	Rigid Vinyl Compounds
ASTM D 2241	PVC Pressure Rated Pipe (SDR Series)
ASTM D 2672	Joints for IPS PVC Pipe Using Solvent Cement
ASTM D 2466	PVC Plastic Fittings, Schedule 40
ASTM D 2564	Solvent Cements for PVC Pipe and Fittings
ASTM F 1668	Procedures for Buried Plastic Pipe
NSF Standard 14	Plastic Piping Components and Related Materials
NSF Standard 61	Drinking Water System Components - Health Effects

Note: Latest revision of each standard applies.

### Short Specification:

Pipe and fittings shall be manufactured from PVC compound with a cell class of 12454 per ASTM D 1784 and conform with National Sanitation Foundation (NSF) standards 14 and 61. Pipe shall be iron pipe size (IPS) conforming to ASTM D 2241 for plain-end pipe and ASTM D 2672 for belled-end pipe. PVC Schedule 40 fittings shall conform to ASTM D 2466.

All pipe and fittings to be produced by a single manufacturer and to be installed in accordance with manufacturer's recommendations and local code requirements. Buried pipe shall be installed in accordance with ASTM F 1668. Solvent cements shall conform to ASTM D 2564, primer shall conform to ASTM F 656. The system to be manufactured by Charlotte Pipe and Foundry Company and is intended for pressure applications where the temperature will not exceed 140°F.

# RECOMMENDED PRODUCT SPECIFICATION

## Suggested Specification

**System:** PVC Schedule 80 Pressure Pipe and Fitting System

**Scope:** This specification covers PVC Schedule 80 pipe and fittings for pressure applications. This system is intended for pressure applications where the operating temperature will not exceed 140°F.

**Specification:** Pipe and fittings shall be manufactured from virgin rigid PVC (polyvinyl chloride) vinyl compounds with a Cell Class of 12454 as identified in ASTM D 1784.

PVC Schedule 80 pipe shall be Iron Pipe Size (IPS) conforming to ASTM D 1785. PVC Schedule 80 fittings shall conform to ASTM D 2467. PVC Schedule 80 threaded fittings shall conform to ASTM D 2464. Pipe and fittings shall be manufactured as a system and be the product of one manufacturer. All pipe and fittings shall be manufactured in the United States. Pipe and fittings shall conform to National Sanitation Foundation (NSF) Standard 61 or the health effects portion of NSF Standard 14.

Installation shall comply with the latest installation instructions published by Charlotte Pipe and Foundry and shall conform to all local plumbing, building, and fire code requirements. Buried pipe shall be installed in accordance with ASTM F 1668. Solvent cement joints shall be made in a two step process with primer manufactured for thermoplastic piping systems and solvent cement conforming to ASTM D 2564. The system shall be protected from chemical agents, fire stopping materials, thread sealant, plasticized vinyl products, or other aggressive chemical agents not compatible with PVC compounds. Systems shall be hydrostatically tested after installation. Testing with compressed air or gas is not recommended. **Testing with compressed air or gas may result in injury or death.**

### Referenced Standards:

ASTM D 1784	Rigid Vinyl Compounds
ASTM D 1785	PVC Plastic Pipe, Schedule 80
ASTM D 2464 or D 2467	PVC Threaded Fittings, Schedule 80
ASTM D 2467	PVC Socket Fittings, Schedule 80
ASTM D 2564	Solvent Cements for PVC Pipe and Fittings
ASTM F 1668	Procedures for Buried Plastic Pipe
NSF Standard 14	Plastic Piping Components and Related Materials
NSF Standard 61	Drinking Water System Components - Health Effects

Note: Latest revision of each standard applies.

### Short Specification:

Pipe and fittings shall be manufactured from PVC compound with a cell class of 12454 per ASTM D 1784 and conform with National Sanitation Foundation (NSF) standards 14 and 61. Pipe shall be iron pipe size (IPS) conforming to ASTM D 1785. Socket fittings shall conform to ASTM D 2467; threaded fittings shall conform to ASTM D 2464 or D 2467. Flanges shall be 150# type per ANSI/ASME B 16.5.

All pipe and fittings to be produced by a single manufacturer and to be installed in accordance with manufacturer's recommendations and local code requirements. Buried pipe shall be installed in accordance with ASTM F 1668. Solvent cements shall conform to ASTM D 2564, primer shall conform to ASTM F 656. The system to be manufactured by Charlotte Pipe and Foundry Company and is intended for pressure applications where the temperature will not exceed 140°F.

# RECOMMENDED PRODUCT SPECIFICATION

## Suggested Specification

**System:** Corzan® CPVC Schedule 80 Pressure Pipe and Fitting System

**Scope:** This specification covers CPVC Schedule 80 pipe and Schedule 80 fittings for pressure applications. This system is intended for pressure applications where the operating temperature will not exceed 200°F.

**Specification:** Pipe and fittings shall be manufactured from virgin rigid CPVC (chlorinated polyvinyl chloride) vinyl compounds with a cell class of 23447 for fittings, 24448 for pipe, as identified in ASTM D 1784.

CPVC Schedule 80 pipe shall be Iron Pipe Size (IPS) conforming to ASTM F 441. CPVC Schedule 80 socket fittings shall conform to ASTM F 439. CPVC Schedule 80 threaded fittings shall conform to ASTM F 437 or F 439. Pipe and fittings shall be manufactured as a system and be the product of one manufacturer. All pipe and fittings shall be manufactured in the United States. Pipe and fittings shall conform to National Sanitation Foundation (NSF) Standard 61 or the health effects portion of NSF Standard 14.

Installation shall comply with the latest installation instructions published by Charlotte Pipe and Foundry and shall conform to all local plumbing, building, and fire code requirements. Buried pipe shall be installed in accordance with ASTM F 1668. Solvent cement joints shall be made in a two step process with primer manufactured for thermoplastic piping systems and solvent cement conforming to ASTM F 493. The system shall be protected from chemical agents, fire stopping materials, thread sealant, plasticized vinyl products, or other aggressive chemical agents not compatible with CPVC compounds. Systems shall be hydrostatically tested after installation. Testing with compressed air or gas is not recommended. **Testing with compressed air or gas may result in injury or death.**

### Referenced Standards:

ASTM D 1784	Rigid Vinyl Compounds
ASTM F 437 or F 439	Threaded CPVC Plastic Fittings, Schedule 80
ASTM F 439	Socket CPVC Plastic Fittings, Schedule 80
ASTM F 441	CPVC Plastic Pipe, Schedule 80
ASTM F 493	Solvent Cements for CPVC Pipe and Fittings
ASTM F 1668	Procedures for Buried Plastic Pipe
NSF Standard 14	Plastic Piping Components and Related Materials
NSF Standard 61	Drinking Water System Components - Health Effects

Note: Latest revision of each standard applies.

Corzan is a registered trademark of The Lubrizol Corporation.

### Short Specification:

Pipe and fittings shall be manufactured from CPVC compound with a cell class of 24448 for pipe and 23447 for fittings per ASTM D 1784 and conform with National Sanitation Foundation (NSF) standards 14 and 61. Schedule 80 pipe shall be iron pipe size (IPS) conforming to ASTM F 441. Schedule 80 socket fittings shall conform to ASTM F 439; threaded fittings shall conform to ASTM F 437 or F 439. Flanges shall be 150# type per ANSI/ASME B 16.5.

All pipe and fittings to be produced by a single manufacturer and to be installed in accordance with manufacturer's recommendations and local code requirements. Buried pipe shall be installed in accordance with ASTM F 1668. Solvent cements shall conform to ASTM F 493, primer shall conform to ASTM F 656. The system to be manufactured by Charlotte Pipe and Foundry Company and is intended for pressure applications where the temperature will not exceed 200°F.

# RECOMMENDED PRODUCT SPECIFICATION

## Suggested Specification

**System:** PVC SDR 35 Gravity Sewer Pipe

**Scope:** This specification covers PVC Standard Dimension Ratio (SDR) 35 PSM pipe for gravity sewer and surface water applications with a pipe stiffness of 46. This product is intended for gravity applications where the operating temperature will not exceed 140°F.

**Specification:** Pipe shall be manufactured from virgin rigid PVC (polyvinyl chloride) vinyl compounds with a cell class of 12364 as identified in ASTM D 1784. The requirements of this specification are intended to provide pipe suitable for non-pressure drainage and surface water.

PVC SDR 35 PSM pipe shall conform to ASTM D 3034 for gasket or solvent weld pipe with a minimum pipe stiffness of 46. Gaskets shall conform to ASTM F 477. The term "PSM" is not an acronym, but rather an arbitrary designation for a product having certain dimensions.

Installation shall comply with the latest installation instructions published by Charlotte Pipe and Foundry and shall conform to all local plumbing, and building requirements. Buried pipe shall be installed in accordance with ASTM D 2321 and ASTM F 1668. Solvent cement joints shall be made in a two step process with primer manufactured for thermoplastic piping systems and solvent cement conforming to ASTM D 2564. The pipe shall be protected from chemical agents, plasticized vinyl products, or other aggressive chemical agents not compatible with PVC compounds. Systems shall be hydrostatically tested after installation. Testing with compressed air or gas is not recommended. **Testing with compressed air or gas may result in injury or death.**

### Referenced Standards:

ASTM D 1784	Rigid Vinyl Compounds
ASTM D 3034	PVC Gravity Sewer Pipe (SDR) 35 PS 46
ASTM D 2855	Joints For Sewer Pipe Using Solvent Cement
ASTM D 2564	Solvent Cements For PVC Sewer Pipe
ASTM F 477	Elastomeric Seals (Gaskets) For Joining Plastic Pipe
ASTM D 2321	Underground Installation of Thermoplastic Pipe (non-pressure applications)
ASTM F 1668	Procedures for Buried Plastic Pipe

Note: Latest revision of each standard applies.

### Short Specification:

Pipe shall be manufactured from PVC compound with a cell class of 12364 as per ASTM D 1784. PVC SDR 35 PSM pipe shall conform to ASTM D 3034 for gasket or solvent weld pipe with a minimum pipe stiffness of 46. Pipe shall be plastic sewer main outside diameter with a standard dimension ratio (SDR) of 35. Gaskets shall conform to ASTM F 477.

All pipe to be produced by a single manufacturer and to be installed in accordance with manufacturer's recommendations and local code requirements. Buried pipe shall be installed in accordance with ASTM D 2321 and ASTM F 1668. Solvent cements shall conform to ASTM D 2564, primer shall conform to ASTM F 656. Pipe to be manufactured by Charlotte Pipe and Foundry Company and is intended for non-pressure gravity sewer and surface water applications.

# RECOMMENDED PRODUCT SPECIFICATION

## Suggested Specification

**System:** PVC Cellular Core (Foam Core) Sewer Pipe PS 50 / Sewer and Drain Series

**Scope:** This specification covers PVC cellular core (foam core) pipe produced to Sewer and Drain outside diameter and have the required wall thickness to meet designated PS (pipe stiffness) 50. This pipe is intended for use in sewer, and storm drainage non-pressure applications where the operating temperature will not exceed 140°F.

**Specification:** Pipe shall be manufactured from virgin rigid PVC (polyvinyl chloride) vinyl compounds with a Cell Class of 11432 as identified in ASTM D 4396. PVC cellular core pipe shall be Sewer and Drain Series outside diameter and have the required wall thickness to meet designated pipe stiffness PS 50 conforming to ASTM F 891. Type PSM Sewer fittings shall conform to ASTM D 3034.

Installation shall comply with the latest installation instructions published by Charlotte Pipe and Foundry and shall conform to all local plumbing, fire, and building code requirements. Buried pipe shall be installed in accordance with ASTM D 2321 and ASTM F 1668. Solvent cement joints shall be made in a two step process with primer manufactured for thermoplastic piping systems and solvent cement conforming to ASTM D 2564. The system shall be protected from chemical agents, fire stopping materials, thread sealant, plasticized vinyl products, or other aggressive chemical agents not compatible with PVC compounds. Systems shall be hydrostatically tested after installation. Testing with compressed air or gas is not recommended. **Testing with compressed air or gas may result in injury or death.**

**Significance and use:**

The requirements of this specification are intended to provide pipe suitable for use in sewer and storm drainage and certain other liquid waste.

**Referenced Standards:**

ASTM D 1784	Rigid PVC Vinyl Compounds
ASTM D 4396	Compounds for Cellular Core Pipe
ASTM F 891	Co-extruded PVC Pipe with Cellular Core
ASTM D 3034	PVC Type PSM Sewer Fittings
ASTM D 2564	Solvent Cements for PVC Pipe and Fittings
ASTM D 2321	Underground Installation of Thermoplastic Pipe (non-pressure applications)
ASTM F 1668	Procedures for Buried Plastic Pipe

Note: Latest revision of each standard applies.

**Short Specification:**

Pipe shall be manufactured from PVC compound with a cell class of 11432 per ASTM D 4396. PVC PS 50 Sewer and Drain Pipe shall conform to ASTM F 891 with a minimum pipe stiffness of 50. Pipe shall be sewer and drain outside diameter.

All pipe to be produced by a single manufacturer and to be installed in accordance with manufacturer's recommendations and local code requirements. Buried pipe shall be installed in accordance with ASTM D 2321 and ASTM F 1668. Solvent cements shall conform to ASTM D 2564, primer shall conform to ASTM F 656. Pipe to be manufactured by Charlotte Pipe and Foundry Company and is intended for non-pressure gravity sewer and storm drainage applications.





This is to certify that all Plastic Pipe and Fittings manufactured by Charlotte Pipe and Foundry Company are manufactured in the United States, and conform to the following standards:

### **SCH. 40 PVC PIPE**

ASTM D 1784, ASTM D 1785, ASTM D 2665  
FHA UM 79a  
FEDERAL SPECIFICATION L-P-320a  
IAPMO IS 9-92, IAPMO 8-92  
IAPMO UPC ON SPECIFIED ITEMS  
NSF STANDARD 14 AND 61

### **SCH. 40 PVC DWV PIPE CELLULAR CORE**

ASTM D 4396, ASTM F 891  
NSF STANDARD NO. 14  
IAPMO UPC

### **SCH. 40 PVC DWV FITTINGS**

ASTM D 1784, ASTM D 2665, ASTM D 3311  
FHA UM 79a  
FEDERAL SPECIFICATION L-P-320a  
NSF STANDARD NO. 14  
IAPMO IS 9-92  
IAPMO UPC ON SPECIFIED ITEMS

### **PVC PRESSURE PIPE SDR-21 AND SDR-26**

ASTM D 1784, ASTM D 2241  
NSF STANDARD NO. 14 AND 61  
IAPMO UPC ON SPECIFIED ITEMS

### **PVC SCH. 40 PRESSURE FITTINGS**

ASTM D 1784, ASTM D 2466  
NSF STANDARD 14 AND 61

### **PVC WELL CASING PIPE**

ASTM D 1784, ASTM F 480  
NSF STANDARD NO. 14 AND 61

### **PVC SCH. 80 PIPE**

ASTM D 1784, ASTM D 1785  
NSF STANDARD NO. 14 AND 61

### **PVC SCH. 80 FITTINGS**

ASTM D 1784, ASTM D 2467  
ASTM D 2464 ASTM F 1970  
NSF STANDARD NO. 14 AND 61

### **PVC SEWER MAIN PIPE**

ASTM D 1784, ASTM D 3034, SDR 35  
ASTM D 3212, ASTM F 477

### **PVC SEWER MAIN PIPE CELLULAR CORE**

ASTM D 4396, ASTM F 891 PS 50

### **PVC THIN WALL PIPE AND FITTINGS**

ASTM D 1784, ASTM D 2949  
NSF STANDARD NO. 14

### **CPVC CTS FLOWGUARD GOLD® PIPE & FITTINGS**

ASTM D 2846  
FHA UM-61a  
NSF STANDARD NO. 14 AND 61  
CSA LISTED ON SPECIFIED ITEMS  
IAPMO UPC ON SPECIFIED ITEMS

### **CPVC SCH. 80 CORZAN® PIPE**

ASTM D 1784, ASTM F 441/F 441M  
NSF STANDARD NO. 14 AND 61

### **CPVC SCH. 80 CORZAN FITTINGS**

ASTM D 1784, ASTM F 439  
ASTM F 437, ASTM F 1970  
NSF STANDARD NO. 14 AND 61

### **CHEMDRAIN® CPVC SCHEDULE 40 PIPE AND FITTINGS**

ASTM D 1784, ASTM F 441, ASTM D 3311  
NSF STANDARD 14 SPECIAL ENGINEERED (SE)

### **SCH. 40 ABS DWV PIPE CELLULAR CORE**

ASTM D 3965, ASTM F 628  
NSF STANDARD NO. 14  
IAPMO UPC ON SPECIFIED ITEMS

### **SCH. 40 ABS DWV FITTINGS**

ASTM D 3965, ASTM D 2661, ASTM D 3311  
FHA UM 79a  
FEDERAL SPECIFICATION L-P-322b  
NSF STANDARD NO. 14  
IAPMO IS 5-92  
IAPMO UPC ON SPECIFIED ITEMS

CHARLOTTE PIPE AND FOUNDRY COMPANY

# PIPE REFERENCE GUIDE



## Pipe Reference Guide

(Updated October 2008)

Product	Sizes Available																					
	1/4	3/8	1/2	3/4	1	1 1/4	1 1/2	2	2 1/2	3	4	4 1/2	5	6	6 1/4	8	10	12	14	15	16	
CPVC Schedule 80	●	●	●	●	●	●	●	●	●	●	●			●		●						
ChemDrain® CPVC Schedule 40 ★							●	●		●	●			●		●						
FlowGuard Gold® CPVC CTS SDR 11			●	●	●	●	●	●														
PVC Schedule 80	●	●	●	●	●	●	●	●	●	●	●		●	●		●	●	●	●			●
PVC Schedule 40			●	●	●	●	●	●	●	●	●		●	●		●	●	●	●			●
PVC Schedule 40 DWV ★						●	●	●	●	●	●		●	●		●	●	●	●			●
PVC Schedule 30										●												
PVC DWV Foam Core ★							●	●		●	●			●		●	●	●				
PVC Well Casing							●	●	●	●	●			●	●	●						
PVC SDR 13.5 (PR315)			●																			
PVC SDR 21 (PR200)				●	●	●	●	●														
PVC SDR 26 (PR160)						●	●	●		●												
PVC SDR 35 Sewer Main Belled-End ★											●			●								
PVC SDR 35 Sewer Main Gasketed ★											●			●		●	●	●			●	
PVC Foam Core Sewer Main PS-50 Belled-End ★											●			●								
ABS DWV Foam Core ★							●	●		●	●			●								

★ Non-Pressure

Notes:

1. End treatments are Plain and Belled. Consult factory for availability.
2. Lengths are 10 and 20 feet (13 and 20 feet for gasketed sewer main). Consult factory for availability and non-standard lengths.
3. PVC Schedule 40 Bell End and PVC Well Casing pipe lengths for sizes 4", 4 1/2", 6", 6 1/4", and 8" are 20 feet plus the bell (20 foot laying length).
4. PVC SDR 35 Sewer Main Pipe in 13 foot lengths are 13 feet plus the bell (13 foot laying length).

**You can't beat the system.®**

"You can't beat the system" and ChemDrain are registered trademarks of Charlotte Pipe and Foundry Company.

# ABS Foam Core DWV Pipe



## >> ABS Schedule 40 DWV Pipe

ABS SCHEDULE 40 FOAM CORE (BLACK) PLAIN END FOR NON-PRESSURE APPLICATIONS ASTM F 628					
PART NO.	NOM. SIZE	UPC # 611942-	AVG. OD (IN.)	MIN. WALL (IN.)	WT. PER 100 FT. (LBS.)
ABS 3112	1½" x 10'	03132	1.900	0.156	28.1
ABS 3112	1½" x 20'	03133	1.900	0.156	28.1
ABS 3200	2" x 10'	03134	2.375	0.156	37.7
ABS 3200	2" x 20'	03135	2.375	0.156	37.7
ABS 3300	3" x 10'	03136	3.500	0.218	77.9
ABS 3300	3" x 20'	03137	3.500	0.218	77.9
ABS 3400	4" x 10'	03138	4.500	0.250	111.4
ABS 3400	4" x 20'	03139	4.500	0.250	111.4
ABS 3600	6" x 10'	03140	6.625	0.281	196.2
ABS 3600	6" x 20'	03141	6.625	0.281	196.2

**NSF Listed. Meets All Requirements of ASTM F 628.**

**ABS piping products are not recommended for use with compressed air or gases.**

## PVC Foam Core DWV Pipe



### >> PVC Schedule 40 DWV Pipe

PVC SCHEDULE 40 FOAM CORE (WHITE)		PLAIN END	FOR NON-PRESSURE APPLICATIONS		ASTM F 891
PART NO.	NOM. SIZE	UPC # 611942-	AVG. OD (IN.)	MIN. WALL (IN.)	WT. PER 100 FT. (LBS.)
PVC 4112	1½" x 10'	04178	1.900	0.145	38.1
PVC 4112	1½" x 20'	04177	1.900	0.145	38.1
PVC 4200	2" x 10'	04174	2.375	0.154	51.2
PVC 4200	2" x 20'	04173	2.375	0.154	51.2
PVC 4300	3" x 10'	03934	3.500	0.216	105.0
PVC 4300	3" x 20'	03935	3.500	0.216	105.0
PVC 4400	4" x 10'	03936	4.500	0.237	146.0
PVC 4400	4" x 20'	03937	4.500	0.237	146.0
PVC 4600	6" x 10'	03938	6.625	0.280	247.0
PVC 4600	6" x 20'	03939	6.625	0.280	247.0
PVC 4800	8" x 20'	03941	8.625	0.322	371.0
PVC 4910	10" x 20'	03942	10.750	0.365	566.0
PVC 4912	12" x 20'	03943	12.750	0.406	755.0

PVC SCHEDULE 40 FOAM CORE (WHITE)		BELL-END	FOR NON-PRESSURE APPLICATIONS		ASTM F 891
PART NO.	NOM. SIZE	UPC # 611942-	AVG. OD (IN.)	MIN. WALL (IN.)	WT. PER 100 FT. (LBS.)
PVC 4300B	3" x 20'	04782	3.500	0.216	105.0
PVC 4400B	4" x 10'	04783	4.500	0.237	146.0
PVC 4400B	4" x 20'	04784	4.500	0.237	146.0
PVC 4600B	6" x 20'	04786	6.625	0.280	247.0

**NOTE:** When ordering, please specify plain end or bell-end.

**NSF Listed. Meets All Requirements of ASTM F 891.**

**PVC piping products are not recommended for use with compressed air or gases.**

# PVC Schedule 40 DWV Pipe



## >> PVC Schedule 40 DWV Pipe

PVC SCHEDULE 40 (WHITE)		PLAIN END	PVC 1120	ASTM D 2665	
PART NO.	NOM. SIZE	UPC # 611942-	AVG. OD (IN.)	MIN. WALL (IN.)	WT. PER 100 FT. (LBS.)
PVC 7100*	1 <sup>1</sup> / <sub>4</sub> "x10'	03945	1.660	.140	42.4
PVC 7100*	1 <sup>1</sup> / <sub>4</sub> "x20'	03946	1.660	.140	42.4
PVC 7112*	1 <sup>1</sup> / <sub>2</sub> "x10'	03947	1.900	.145	50.7
PVC 7112*	1 <sup>1</sup> / <sub>2</sub> "x20'	03948	1.900	.145	50.7
PVC 7200*	2"x10'	03949	2.375	.154	68.1
PVC 7200*	2"x20'	03950	2.375	.154	68.1
PVC 4025*	2 <sup>1</sup> / <sub>2</sub> "x20'	04205	2.875	.203	108.0
PVC 7300*	3"x10'	03951	3.500	.216	141.2
PVC 7300*	3"x20'	03952	3.500	.216	141.2
PVC 7400*	4"x10'	03953	4.500	.237	201.2
PVC 7400*	4"x20'	03954	4.500	.237	201.2
PVC 7500*	5"x20'	04837	5.563	.258	272.5
PVC 7600*	6"x10'	03955	6.625	.280	353.7
PVC 7600*	6"x20'	03956	6.625	.280	353.7
PVC 7800*	8"x20'	03958	8.625	.322	532.3
PVC 7910*	10"x20'	03959	10.750	.365	754.7
PVC 7912*	12"x20'	03961	12.750	.406	997.9
PVC 7914*	14"x20'	04862	14.000	.437	1180.1
PVC 7916*	16"x20'	04918	16.000	.500	1543.1

\* Dual Marked ASTM D 1785 & ASTM D 2665.

NSF Listed. Meets All Requirements of ASTM D 1784, ASTM D 1785, and ASTM D 2665.

**PVC piping products are not recommended for use with compressed air or gases.**

# PVC Pipe: Schedule 40



## >> PVC Schedule 40 Pipe - Plain End

PVC SCHEDULE 40 (WHITE)		PLAIN END		PVC 1120	ASTM D 1785	
PART NO.	NOM. SIZE	UPC # 611942-	AVG. OD (IN.)	MIN. WALL (IN.)	MAX WORK PRESSURE AT 23° C OR 73° F	WT. PER 100 FT. (LBS.)
PVC 4005	1/2"x10'	06658	.840	.109	600 PSI	15.9
PVC 4005	1/2"x20'	03922	.840	.109	600 PSI	15.9
PVC 4007	3/4"x10'	06661	1.050	.113	480 PSI	21.1
PVC 4007	3/4"x20'	03925	1.050	.113	480 PSI	21.1
PVC 4010	1"x10'	06664	1.315	.133	450 PSI	31.3
PVC 4010	1"x20'	03928	1.315	.133	450 PSI	31.3
PVC 7100*	1 1/4"x10'	03945	1.660	.140	370 PSI	42.4
PVC 7100*	1 1/4"x20'	03946	1.660	.140	370 PSI	42.4
PVC 7112*	1 1/2"x10'	03947	1.900	.145	330 PSI	50.7
PVC 7112*	1 1/2"x20'	03948	1.900	.145	330 PSI	50.7
PVC 7200*	2"x10'	03949	2.375	.154	280 PSI	68.1
PVC 7200*	2"x20'	03950	2.375	.154	280 PSI	68.1
PVC 4025*	2 1/2"x20'	04205	2.875	.203	300 PSI	108.0
PVC 7300*	3"x10'	03951	3.500	.216	260 PSI	141.2
PVC 7300*	3"x20'	03952	3.500	.216	260 PSI	141.2
PVC 7400*	4"x10'	03953	4.500	.237	220 PSI	201.2
PVC 7400*	4"x20'	03954	4.500	.237	220 PSI	201.2
PVC 7500*	5"x20'	04837	5.563	.258	190 PSI	272.5
PVC 7600*	6"x10'	03955	6.625	.280	180 PSI	353.7
PVC 7600*	6"x20'	03956	6.625	.280	180 PSI	353.7
PVC 7800*	8"x20'	03958	8.625	.322	160 PSI	532.3
PVC 7910*	10"x20'	03959	10.750	.365	140 PSI	754.7
PVC 7912*	12"x20'	03961	12.750	.406	130 PSI	997.9
PVC 7914*	14"x20'	04862	14.000	.437	130 PSI	1180.1
PVC 7916*	16"x20'	04918	16.000	.500	130 PSI	1543.1

\* Dual marked ASTM D 1785 and ASTM D 2665.

NOTE: When ordering, please specify plain end or bell end.

NSF Listed. Meets All Requirements of ASTM D 1784 and ASTM D 1785.

PVC piping products are not recommended for use with compressed air or gases.

All Charlotte Pipe and Foundry Company Products are made in U.S.A.

You can't beat the system.®

# PIPE DATA

## >> PVC Schedule 40 Pipe - Bell End\*

PVC SCHEDULE 40 (WHITE)			BELL END		PVC 1120	ASTM D 1785	
PART NO.	NOM. SIZE	UPC # 611942-	AVG. OD (IN.)	MIN. WALL (IN.)	MAX WORK PRESSURE AT 23° C OR 73° F	BELL DEPTH (IN.)	WT. PER 100 FT. (LBS.)
PVC 4005B**	1/2"x10'	04986	.840	.109	600 PSI	2.00	15.9
PVC 4005B**	1/2"x20'	03923	.840	.109	600 PSI	2.00	15.9
PVC 4007B**	3/4"x10'	04987	1.050	.113	480 PSI	2.25	21.1
PVC 4007B**	3/4"x20'	03926	1.050	.113	480 PSI	2.25	21.1
PVC 4010B**	1"x10'	04988	1.315	.133	450 PSI	2.50	31.3
PVC 4010B**	1"x20'	03929	1.315	.133	450 PSI	2.50	31.1
PVC 4012B§	1 1/4"x10'	04989	1.660	.140	370 PSI	2.75	42.4
PVC 4012B§	1 1/4"x20'	03930	1.660	.140	370 PSI	2.75	42.4
PVC 4015B§	1 1/2"x10'	04990	1.900	.145	330 PSI	3.00	50.7
PVC 4015B§	1 1/2"x20'	03931	1.900	.145	330 PSI	3.00	50.7
PVC 4020B†	2"x10'	04991	2.375	.154	280 PSI	4.00	69.2
PVC 4020B†	2"x20'	03932	2.375	.154	280 PSI	4.00	69.2
PVC 4025B‡	2 1/2"x10'	04992	2.875	.203	300 PSI	4.00	110.0
PVC 4025B‡	2 1/2"x20'	04206	2.875	.203	300 PSI	4.00	110.0
PVC 7300B§	3"x10'	04853	3.500	.216	260 PSI	4.00	145.1
PVC 4030B†	3"x20'	03933	3.500	.216	260 PSI	4.00	144.5
PVC 7400B§	4"x10'	04835	4.500	.237	220 PSI	4.00	207.9
PVC 9400B†	4"x20'	03964	4.500	.237	220 PSI	5.00	206.2
PVC 7600B§	6"x10'	04850	6.625	.280	180 PSI	6.50	371.4
PVC 9600B†	6"x20'	03965	6.625	.280	180 PSI	6.50	365.5
PVC 7800B†	8"x10'	09903	8.625	.322	160 PSI	7.00	556.9
PVC 9800B†	8"x20'	03967	8.625	.322	160 PSI	7.00	552.3
PVC 7910B†	10"x10'	00990	10.750	.365	140 PSI	9.00	791.9
PVC 7910B†	10"x20'	03960	10.750	.365	140 PSI	9.00	785.4
PVC 7912B†	12"x20'	03962	12.750	.406	130 PSI	10.00	1046.7
PVC 7914B†	14"x20'	04863	14.000	.437	130 PSI	10.00	1180.1
PVC 7916B†	16"x20'	04929	16.000	.500	130 PSI	10.00	1543.1

\* Bell dimensions meet either ASTM D 2672 or  
ASTM F 480, depending upon pipe diameter  
\*\* ASTM D 1785

§ Dual Marked ASTM D 1785 & ASTM D 2665  
† Triple Marked ASTM D 1785 & ASTM D 2665 & ASTM F 480  
‡ Dual Marked ASTM D 1785 & ASTM F 480

PVC piping products are not recommended for use with compressed air or gases.

# PIPE DATA

## >> PVC Well Casing

PVC SCHEDULE 40 (WHITE)		BELL END WELL CASING			PVC 1120	ASTM F 480	
PART NO.	NOM. SIZE	UPC # 611942-	AVG. OD (IN.)	MIN. WALL (IN.)	BELL DEPTH (IN.)	WT. PER 100 FT. (LBS.)	
PVC 4020B	2"x20'	03932	2.375	.154	4.00	69.2	
PVC 4025B	2½"x20'	04206	2.875	.203	4.00	110.0	
PVC 4030B	3"x20'	03933	3.500	.216	4.00	144.5	
PVC 9400B	4"x20'	03964	4.500	.237	5.00	206.2	
PVC 9600B	6"x20'	03965	6.625	.280	6.50	365.5	
PVC 9800B	8"x20'	03967	8.625	.322	7.00	552.3	

SDR 17 and DR 27.6		BELL END WELL CASING			PVC 1120	ASTM F 480	
PART NO.	NOM. SIZE	UPC # 611942-		AVG. OD (IN.)	MIN. WALL (IN.)	BELL DEPTH (IN.)	WT. PER 100 FT. (LBS.)
PVC 9450B	4½"x20'	04159	SDR 17	4.950	.291	5.50	278.4
PVC 9625B	6¼"x20'	03966	DR 27.6	6.900	.250	7.00	342.7

## >> PVC SDR Pipe

PR 200	PVC 1120	BELL END			ASTM D 2241	SDR 21	
PART NO.	NOM. SIZE	UPC # 611942-	AVG. OD (IN.)	MIN. WALL (IN.)	MAX WORK PRESSURE AT 23° C OR 73° F	BELL DEPTH (IN.)	WT. PER 100 FT. (LBS.)
PVC 23155B	*1½"x20'	03991	.840	.062	315 PSI	2.00	10.0
PVC 20007B	¾"x10'	10742	1.050	.060	200 PSI	2.25	11.8
PVC 20007B	¾"x20'	03984	1.050	.060	200 PSI	2.25	11.8
PVC 20010B	1"x20'	03986	1.315	.063	200 PSI	2.50	15.7
PVC 20012B	1¼"x20'	03987	1.660	.079	200 PSI	2.75	24.9
PVC 20015B	1½"x20'	03988	1.900	.090	200 PSI	3.00	32.4
PVC 20020B	2"x20'	03989	2.375	.113	200 PSI	4.00	50.9

\*PR 315 / SDR 13.5

PR 160	PVC 1120	BELL END			ASTM D 2241	SDR 26	
PART NO.	NOM. SIZE	UPC # 611942-	AVG. OD (IN.)	MIN. WALL (IN.)	MAX WORK PRESSURE AT 23° C OR 73° F	BELL DEPTH (IN.)	WT. PER 100 FT. (LBS.)
PVC 16012B	1¼"x20'	04211	1.660	.064	160 PSI	2.75	20.3
PVC 16015B	1½"x20'	04210	1.900	.073	160 PSI	3.00	26.6
PVC 16020B	2"x20'	04212	2.375	.091	160 PSI	4.00	41.4
PVC 16030B	3"x20'	04222	3.500	.135	160 PSI	4.00	92.3

NOTE: When ordering, please specify plain end or bell end.

PVC piping products are not recommended for use with compressed air or gases.



You can't beat the system.®





# PVC Schedule 80 Pipe



## >> PVC Schedule 80 Pipe, Type 1, Grade 1 - Plain End

ASTM D 1784 & ASTM D 1785

PVC SCHEDULE 80 (GRAY)			PLAIN END			PVC 1120
PART NO.	NOM. SIZE	UPC # 611942-	AVG. OD (IN.)	MIN. WALL (IN.)	MAX WORK PRESSURE AT 23° C OR 73° F	WT. PER 100 FT. (LBS.)
PVC 10002	1/4"x20'	04920	0.540	.119	1130 PSI	10.0
PVC 10003	3/8"x20'	04917	0.675	.126	920 PSI	13.8
PVC 10005	1/2"x20'	03968	0.840	.147	850 PSI	20.3
PVC 10007	3/4"x20'	03969	1.050	.154	690 PSI	27.5
PVC 10010	1"x20'	03970	1.315	.179	630 PSI	40.5
PVC 10012	1 1/4"x20'	03973	1.660	.191	520 PSI	55.9
PVC 10015	1 1/2"x20'	03976	1.900	.200	470 PSI	67.7
PVC 10020	2"x20'	03977	2.375	.218	400 PSI	93.6
PVC 10025	2 1/2"x20'	03978	2.875	.276	420 PSI	142.8
PVC 10030	3"x20'	03979	3.500	.300	370 PSI	191.1
PVC 10040	4"x20'	03980	4.500	.337	320 PSI	279.3
PVC 10050	5"x20'	04831	5.563	.375	290 PSI	387.3
PVC 10060	6"x20'	03981	6.625	.432	280 PSI	532.7
PVC 10080	8"x20'	04175	8.625	.500	250 PSI	808.9
PVC 10100	10"x20'	04768	10.750	.593	230 PSI	1199.3
PVC 10120	12"x20'	04770	12.750	.687	230 PSI	1650.1
PVC 10140	14"x20'	04816	14.000	.750	220 PSI	1930.0
PVC 10160	16"x20'	04919	16.000	.843	220 PSI	2544.1

NSF Listed. Meets All Requirements of ASTM D 1784 and ASTM D 1785.

PVC piping products are not recommended for use with compressed air or gases.

You can't beat the system.®

# BELLED-END PIPE DIMENSIONS

## Socket Dimensions For Belled-End Pipe

NOM. Pipe size	ASTM Standard	SOCKET ENTRANCE (A)		SOCKET BOTTOM (B)		SOCKET LENGTH (C)		
		I.D. Min.	I.D. Max.	I.D. Min.	I.D. Max.	SDR	Schedule 40	Schedule 80
1/2	D 2672	.844	0.852	0.832	0.840	2.000	2.000	1.000
3/4	D 2672	1.054	1.062	1.042	1.050	2.250	2.250	1.250
1	D 2672	1.320	1.330	1.305	1.315	2.500	2.500	1.500
1 1/4	D 2672	1.665	1.675	1.650	1.660	2.750	2.750	1.750
1 1/2	D 2672	1.906	1.918	1.888	1.900	3.000	3.000	2.000
2	D 2672	2.381	2.393	2.357	2.369	4.000	—	2.250
2	F 480	2.380	2.392	2.357	2.369	—	4.000	—
2 1/2	D 2672	2.882	2.896	2.854	2.868	4.000	—	2.500
2 1/2	F 480	2.880	2.894	2.854	2.868	—	4.000	—
3	D 2672	3.508	3.524	3.476	3.492	4.000	—	3.250
3	F 480	3.506	3.522	3.476	3.492	—	4.000	—
4	D 2672	4.509	4.527	4.473	4.491	5.000	—	4.000
4	F 480	4.508	4.526	4.473	4.491	—	5.000	—
6	D 2672	6.636	6.658	6.592	6.614	6.500	—	6.000
6	F 480	6.637	6.659	6.592	6.614	—	6.500	—
8	D 2672	8.640	8.670	8.583	8.613	—	—	6.000
8	F 480	8.634	8.664	8.583	8.613	—	7.000	—
10	D 2672	10.761	10.791	10.707	10.737	—	9.000	7.500
12	D 2672	12.763	12.793	12.706	12.736	—	10.000	8.500
14	D 2672	14.020	14.050	13.970	14.000	—	10.000	9.000
16	D 2672	16.030	16.060	15.965	15.995	—	10.000	—

Note: All dimensions are in inches.

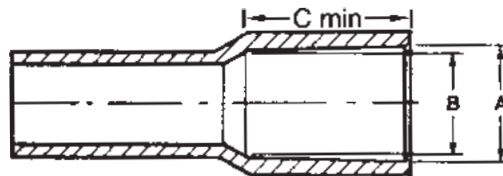

# OUTSIDE DIAMETER AND THICKNESS

# CPVC Schedule 80 Pipe



>> **CORZAN** CPVC Schedule 80 Pipe, Type IV, Grade 1

ASTM D 1784 & ASTM F 441

CPVC SCHEDULE 80 (LIGHT GRAY)			PLAIN END		CPVC 4120	
PART NO.	NOM. SIZE	UPC # 611942-	AVG. OD (IN.)	MIN. WALL (IN.)	MAX WORK PRESSURE AT 23° C OR 73° F	WT. PER 100 FT. (LBS.)
CPV 11002	1/4"x20'	04931	.540	.119	1130 PSI	10.9
CPV 11003	3/8"x20'	04943	.675	.126	920 PSI	15.0
CPV 11005	1/2"x20'	04787	.840	.147	850 PSI	22.1
CPV 11007	3/4"x20'	04788	1.050	.154	690 PSI	30.0
CPV 11010	1"x20'	04789	1.315	.179	630 PSI	44.2
CPV 11012	1 1/4"x20'	04790	1.660	.191	520 PSI	61.0
CPV 11015	1 1/2"x20'	04791	1.900	.200	470 PSI	73.9
CPV 11020	2"x20'	04792	2.375	.218	400 PSI	102.2
CPV 11025	2 1/2"x20'	04793	2.875	.276	420 PSI	155.9
CPV 11030	3"x20'	04794	3.500	.300	370 PSI	208.6
CPV 11040	4"x20'	04795	4.500	.337	320 PSI	304.9
CPV 11060	6"x20'	04796	6.625	.432	280 PSI	581.5
CPV 11080	8"x20'	04797	8.625	.500	250 PSI	882.9

NSF Listed. Meets All Requirements of ASTM D 1784 and ASTM F 441.

CPVC piping products are not recommended for use with compressed air or gases.

Corzan is a registered trademark of The Lubrizol Corporation.

You can't beat the system.®

# PVC Sewer Pipe

## >> PVC SDR 35 PSM Pipe

ASTM D 3034 &amp; ASTM F 477

SDR-35		GASKETED - PS 46						
PART NO.	NOM. SIZE	UPC # 611942-	QTY. PER SKID	TRUCKLOAD PERCENT PER SKID	LAYING LENGTH	WT. PER 100 FT. (LBS.)	AVG. OD (IN.)	MIN. WALL (IN.)
S/M 6004G	4"x13'	04011	780	4.763	13'-0"	110.4	4.215	.120
S/M 6004G	4"x20'	04012	1200	7.144	20'-0"	109.7	4.215	.120
S/M 6006G	6"x13'	04015	364	4.763	13'-0"	249.6	6.275	.180
S/M 6006G	6"x20'	04016	560	8.330	20'-0"	247.0	6.275	.180
S/M 6008G	8"x13'	04020	130	3.330	13'-0"	451.0	8.400	.240
S/M 6008G	8"x20'	04021	200	5.000	20'-0"	442.7	8.400	.240
S/M 6010G	10"x13'	04023	104	4.160	13'-0"	709.0	10.500	.300
S/M 6012G	12"x13'	04026	78	4.763	13'-0"	1024.9	12.500	.360
S/M 6015G	15"x13'	04029	78	5.550	13'-0"	1523.2	15.300	.437

Weight is approximate and is for shipping purposes only.

SDR-35		SOLVENT WELD - PS 46						
PART NO.	NOM. SIZE	UPC # 611942-	QTY. PER SKID	TRUCKLOAD PERCENT PER SKID	LAYING LENGTH	WT. PER 100 FT. (LBS.)	AVG. OD (IN.)	MIN. WALL (IN.)
S/M 6004	4"x10'	04008	600	4.160	10'-0"	112.0	4.215	.120
S/M 6004	4"x20'	04009	1200	7.144	20'-0"	109.7	4.215	.120
S/M 6006	6"x10'	04013	280	4.160	10'-0"	252.0	6.275	.180
S/M 6006	6"x20'	04014	560	8.330	20'-0"	246.0	6.275	.180

Weight is approximate and is for shipping purposes only.

**NOTE:** For truckloads of mixed sizes, multiply skids desired by truckload percent per skid.

Meets All Requirements of ASTM D 3034.

SDR 35 Gaskets meet or exceed ASTM F 477. Gasketed joints meet ASTM D 3212.

**Sewer pipe is not pressure rated and should not be used for pressure systems.**

**PVC piping products are not recommended for use with compressed air or gases.**

You can't beat the system.®

# PVC Foam Core Sewer Pipe

>> **PVC Foam Core Gravity Sewer Pipe - PS 50/Sewer and Drain Series**

SOLVENT WELD							ASTM F 891
PART NO.	NOM. SIZE	UPC # 611942-	QTY. PER SKID	TRUCKLOAD PERCENT PER SKID	AVG. OD (IN.)	MIN. WALL (IN.)	WT. PER 100 FT. (LBS.)
S/M 5400	4"x10'	04002	600	4.160	4.215	.124	82.8
S/M 5400	4"x20'	04003	1200	7.144	4.215	.124	82.8
S/M 5600	6"x10'	04004	280	4.160	6.275	.185	167.0
S/M 5600	6"x20'	04005	560	8.330	6.275	.185	167.0

Weight is approximate and is for shipping purposes only.

NOTE: For truckloads of mixed sizes, multiply skids desired by truckload percent per skid.

Pipe listed in this section meets or exceeds the requirements of ASTM F 891 PS 50 Series.

Sewer pipe is not pressure rated and should not be used for pressure systems.

PVC piping products are not recommended for use with compressed air or gases.

You can't beat the system.®

# PRESSURE/TEMPERATURE RELATIONSHIP

The operating pressure of PVC and CPVC pipe will be reduced as the operating temperature increases above 73° F. To calculate this reduction, multiply the operating pressures shown on the previous pages by the correction factors shown below:

Operating Temperature (°F)	Correction Factors	
	PVC	CPVC
73	1.00	1.00
80	.88	1.00
90	.75	.91
100	.62	.82
110	.50	.77
120	.40	.65
130	.30	.62
140	.22	.50
150	NR	.47
160	NR	.40
170	NR	.32
180	NR	.25
200	NR	.20

For example, the operating pressure for 6" Schedule 80 CPVC pipe is 280 psi. If the operating temperature is 140° F, the maximum operating pressure is now 140 psi (280 x .50).

Note: Operating temperatures above 140° F for PVC and 180° F for SDR 11 FlowGuard Gold® and 200° F for CPVC schedule 80 piping products are not recommended.

Pressure ratings shown are for socket (solvent cement) systems. The system must always be de-rated to the pressure rating of the lowest rated system component at the expected maximum system operating temperature. For pressure ratings of flanges or unions, see the information on those components elsewhere in this technical manual. Pressure ratings of molded or cut threads are 50% of solvent cement systems. For pressure ratings of valves or other system components, always consult the technical recommendations from the manufacturers of those products.

## Low Temperature Recommendation

Like most materials, PVC and CPVC become more brittle at low temperatures, particularly at temperatures below freezing (32°F). Charlotte Pipe and Foundry recommends taking proper precautions when installing systems at low temperatures including providing proper insulation. If a system is designed to operate at temperatures below freezing (32°F), Charlotte Pipe recommends the following:

1. Reduce water hammer pressure surges to a minimum by:
  - a. Using only slow acting solenoid valves, if any;
  - b. Reducing pump start-up pressure surges with slow start-up motors and rubber expansion devices;
  - c. Not exceeding a maximum fluid velocity of 5-feet per second.
2. Provide more than minimum Charlotte Pipe recommended support spacing.
3. Thrust blocking at branches, changes in direction and end of runs.
4. Use expansion/contraction devices when temperature changes occur in runs.
5. Strictly follow chemical resistance recommendations.
6. Protect piping from UV, if applicable.

## Gravity Flow

Fluid velocity, pipe size and hydraulic slope for gravity drainage can be determined using the Manning "N" value. This coefficient relates to the interior wall smoothness of pipe and is used for liquids with a steady flow, at a constant depth, in a prismatic open channel. The Manning's equation is shown below:

$$V = \frac{1.486 R^{2/3} S^{1/2}}{N}$$

Where:

V = Velocity of flow, ft./second

N = Manning's value

r = hydraulic radius, ft. obtained by dividing the cross sectional area of flow by the wetted perimeter of the pipe in contact with the flow.  
R is a special case for v with pipes either 1/2 full or full:

R = Inside diameter / 4, in feet

$$S = \frac{\text{Upstream elevation} - \text{Down stream elevation}}{\text{pipe length}} \text{ (ft./ft.)}$$

Example 1:

2" diameter schedule 40 PVC,  
flowing full 30 foot pipe run, 7.5 inch drop

$$S = \frac{17.5" - 10.0"}{30 \text{ ft.}} = 0.0208 \text{ ft./ft.}$$

$$R = \frac{2.067"}{4} = 0.043 \text{ ft.}$$

$$V = \frac{1.486 R^{2/3} S^{1/2}}{N}$$

Manning's "N" value is generally accepted as 0.009 for Designing gravity sewer systems

$$V = \frac{1.486 (0.043)^{2/3} (0.0208)^{1/2}}{0.009}$$

$$V = 2.9 \text{ ft./second}$$

Example 2:

4" diameter schedule 40 ABS, flowing 1/2 full  
10 foot pipe run, 1.5 inch drop

$$S = \frac{20" - 18.5"}{10 \text{ ft.}} = 0.0125 \text{ ft./ft.}$$

$$R = \frac{4.026"}{4} = 0.0839 \text{ ft.}$$

Assume "N" to be 0.010

$$V = \frac{1.486 (0.0839)^{2/3} (0.0125)^{1/2}}{0.010}$$

$$V = 3.2 \text{ ft./second}$$

It is widely recommended that the flow velocity in sanitary sewer systems to be equal to or greater than 2.0 feet per second for self cleaning drain lines.

Laboratory tests have shown that the "N" value for ABS and PVC pipe ranges from .008 to .012. The table below shows "N" values for other piping materials.

### "N" Values For Typical Piping Materials

Piping Material	"N" Values
Cast Iron	.011 - .015
Finished Concrete	.011 - .015
Unfinished Concrete	.013 - .017
Corrugated Metal	.021 - .027
Glass	.009 - .013
Clay	.011 - .017

## Fluid Flow Rate

Calculation of Volume Flow Rate:

Where:

$$Q = aV$$

a = Cross sectional area of flow, ft.<sup>2</sup>

V = Flow Velocity, ft/sec

Q = Volume flow rate, ft<sup>3</sup>/sec

Example 1:

2" Schedule 40 PVC

$$a = \frac{\pi Di^2}{4} = \frac{\pi (2.067/12)^2}{4} = 0.0233 \text{ ft}^2$$

$$V = 2.9 \text{ ft/sec}$$

$$Q = 0.0233 \times 2.9 = 0.0676 \text{ ft}^3/\text{sec}$$

$$Q = \frac{0.0676 \text{ ft}^3}{\text{sec}} \times \frac{7.48 \text{ gal}}{\text{ft}^3} \times \frac{60 \text{ sec}}{\text{min}} = \frac{30.3 \text{ gals}}{\text{min}}$$

Example 2:

4" Schedule 40 PVC

$$a = \frac{1}{2} \left( \frac{\pi Di^2}{4} \right) = \frac{\pi (4.026/12)^2}{2 \times 4} = 0.0442 \text{ ft}^2$$

$$V = 3.2 \text{ ft/sec}$$

$$Q = 0.0442 \times 3.2 = 0.141 \text{ ft}^3/\text{sec}$$

$$Q = \frac{0.141 \text{ ft}^3}{\text{sec}} \times \frac{7.48 \text{ gal}}{\text{ft}^3} \times \frac{60 \text{ sec}}{\text{min}} = \frac{63.5 \text{ gals}}{\text{min}}$$

## Pressure Flow

Friction loss through PVC pipe is normally obtained by using the Hazen-Williams equation shown below for water:

$$f = 0.2083 \times \left(\frac{100}{C}\right)^{1.852} \times \frac{Q^{1.852}}{di^{4.8655}}$$

Where:

f = friction head loss in feet of water per 100 feet of pipe

C = constant for inside pipe roughness (C = 150 for ABS and PVC pipe)

Q = flow in U.S. gallons per minute

di = inside diameter of pipe in inches

## Water Velocities

Water velocities in feet per second may be calculated as follows:

$$V = 0.408709 \frac{Q}{di^2}$$

Where:

V = velocity in feet per second

Q = flow in U.S. gallons per minute

di = inside diameter of pipe in inches

## Manning Roughness Factor ("N" Value)

Laboratory tests have shown that the "N" value for ABS and PVC pipe ranges from .008 to .012. The table below shows "N" values for other piping materials.

### "N" Values For Typical Piping Materials

Piping Material	"N" Values
Cast Iron	.011 - .015
Finished Concrete	.011 - .015
Unfinished Concrete	.013 - .017
Corrugated Metal	.021 - .027
Glass	.009 - .013
Clay	.011 - .017

## Friction Loss Through Fittings

The friction loss through fittings is considered to be equivalent to the loss through a certain number of linear feet of pipe of the same diameter as the fittings. To determine the loss through a piping system, add together the number of "equivalent feet" calculated for the fittings in the system.

The chart below shows approximate friction losses, in equivalent feet, for a variety of ABS and PVC fittings of different sizes.

## Approximate Friction Loss For ABS and PVC Fittings In Equivalent Feet Of Straight Pipe

Fitting	1/2"	3/4"	1"	1 1/4"	1 1/2"	2"	2 1/2"	3"	4"	6"	8"
Tee (Run)	1.0	1.4	1.7	2.3	2.7	4.3	5.1	6.2	8.3	12.5	16.5
Tee (Branch)	4.0	5.0	6.0	7.3	8.4	12.0	15.0	16.4	22.0	32.7	49.0
90° Elbow	1.5	2.0	2.5	3.8	4.0	5.7	6.9	7.9	12.0	18.0	22.0
45° Elbow	.80	1.1	1.4	1.8	2.1	2.6	3.1	4.0	5.1	8.0	10.6
Male/Female Adapter	1.0	1.5	2.0	2.75	3.5	4.5	5.5	6.5	9.0	14.0	—

The table on page 37 shows friction heads in feet and friction losses in psi for schedule 40 pipe. It also shows the gallons per minute (GPM) and velocities (in feet per second) for various pipe sizes.



## Water Hammer

Water hammer is a term used to describe the sudden increase in pressure created by quickly stopping, starting, or changing the direction of the flow of fluid in a piping system. Typical actions which cause water hammer are:

- (1) Quickly closing a valve.
- (2) Quickly opening a valve.
- (3) Starting pumps with an empty discharge line.
- (4) A high speed wall of liquid (such as starting a pump) suddenly changes direction (such as going through a 90° elbow).
- (5) Moving entrapped air through the system.

The pressure increase generated must be added to the fluid pressure already existing in the piping system to determine the total pressure the system must withstand. If water hammer is not accounted for, the sudden pressure surge could be enough to burst the pipe, or break the fittings or valves.

## How To Use The Nomograph On The Following Page:

1. Liquid Velocity (feet/second), pipeline length (feet), and valve closing time (seconds) must be known.
2. Place a straight edge on the liquid velocity in pipe (line A) and the pipeline length (line D).
3. Mark intersection of straight edge with pivot line (line C).
4. Place straight edge on mark just placed on pivot line (line C) and on valve closing time for valve being used (line A).
5. The intersection of the straight edge with the pressure increase line (line B) is the liquid momentum surge pressure (water hammer).

Taking the following measures will help prevent problems:

- (1) Keep fluid velocities under 5 feet per second.
- (2) Use actuated valves with controlled opening and closing speeds.
- (3) Instruct operators of manual valves on the proper opening and closing speeds.
- (4) When starting a pump, partially close the valve in the discharge line to minimize the volume of liquid accelerating through the system. Fully open the valve after the line is completely filled.
- (5) Use a check valve in the pipe line, near the pump, to keep the line full.
- (6) Use air relief valves to control the amount of air that is admitted or exhausted throughout the piping system.
- (7) Design the piping system so that the total pressure (operating plus water hammer surge) does not exceed the pressure rating of the lowest rated component in the system.

The liquid momentum surge pressure should be added to the operating line pressure to determine the system's maximum line pressure. The maximum line pressure is used to select the proper pipe schedule or wall thickness.

The nomograph is based on the formula

$$P = \frac{0.070VL}{T}$$

where P is increase in pressure due to momentum surge in psi, L is pipeline length in feet, V is liquid velocity in feet per second, and T is valve closing time in seconds.

## Water Hammer Nomograph

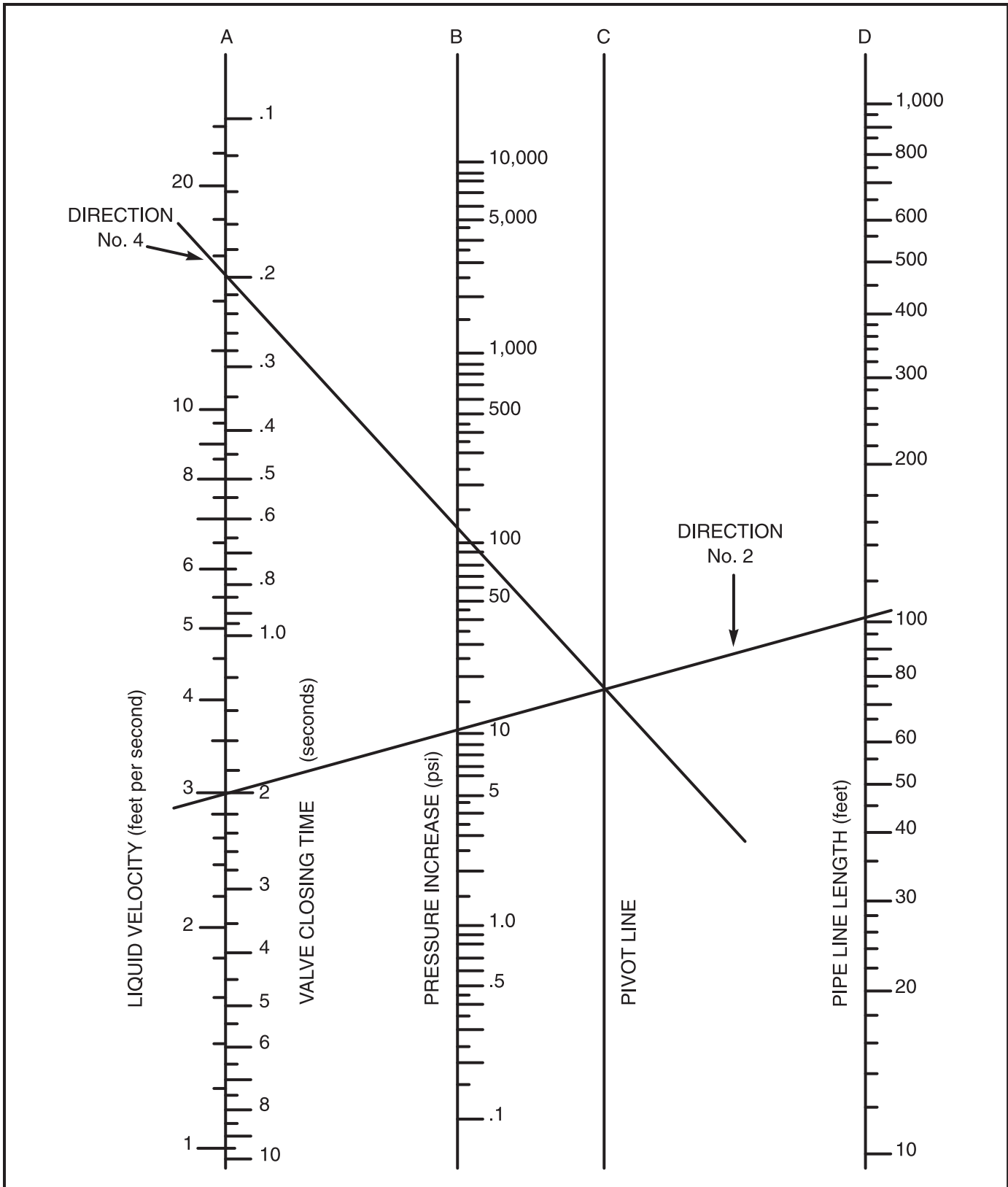

## Entrapped Air

### Source

There are many potential sources for air in pipelines. Air may be introduced at the point where fluid enters the system or during initial filling of the system.

### Problem

Air in a piping system tends to accumulate at high points in the system. As the flowrate increases, the entrapped air is forced along the pipeline by the moving water. These pockets of air cause flow restrictions reducing the efficiency and performance of the system. Water is about 5 times more dense than air at 100 psi, so when a pocket of air reaches an outlet, it escapes rapidly and water rushes to

replace the void. Such pressure surges can easily exceed the strength of a piping system and it's components.

### Solution

Designers should be concerned about entrapped air, but the issue of entrapped air is very complex. The behavior of air in a piping system is not easy to analyze, but the effects can be devastating. Obviously, the best way to reduce problems would be to prevent air from entering the system. Systems should be filled slowly and air vented from the high points before the system is pressurized. Additionally, air relief valves should be installed at high points in the system to vent air that accumulates during service.

## WEATHERING

### UV Exposure

PVC and CPVC pipe can suffer surface discoloration when exposed to ultraviolet (UV) radiation from sunlight. UV radiation affects PVC and CPVC when energy from the sun causes excitation of the molecular bonds in the plastic. The resulting reaction occurs only on the exposed surface of the pipe and to the extremely shallow depths of .001 to .003 inches. The effect does not continue when exposure to sunlight is terminated.

A two-year study was undertaken to quantify the effects of UV radiation on the properties of PVC pipe (See Uni-Bell's UNI-TR-5). The study found that exposure to UV radiation results in a change in the pipe's surface color and a reduction in impact strength. Other properties such as tensile strength (pressure rating) and modulus of elasticity (pipe stiffness) are not adversely affected.

The presence of an opaque shield between the sun and the pipe prevents UV degradation. UV radiation will not penetrate thin shields such as paint coatings or wrappings. Burial of PVC pipe provides complete protection against UV attack.

The most common method used to protect above ground PVC pipe from the sun is painting with a latex (water base) paint. Preparation of the surface to be painted is very important. The pipe should be cleaned to remove moisture, dirt, and oil and wiped with a clean, dry cloth. Petroleum-based paints should not be used, since the presence of petroleum will prevent proper bonding of paint to pipe.

Reference Uni-Bell PVC Pipe Association 2001

# FRICION LOSS AND FLOW VELOCITY FOR SCHEDULE 40 THERMOPLASTIC PIPE

(Friction head and friction loss are per 100 feet of pipe.) CAUTION: Flow velocity should not exceed 5 feet per second. ABS and PVC pipe cannot be used for compressed air service. Flow velocity required to obtain a self cleaning drain, waste, and vent plumbing system is 2.0 to 2.5 feet per second.

Gallons Per Minute	1/2 in.			3/4 in.			1 in.			1 1/4 in.			1 1/2 in.			2 in.			2 1/2 in.			3 in.		
	Velocity Feet Per Second	Friction Head Feet	Friction Loss Pounds Per Square Inch	Velocity Feet Per Second	Friction Head Feet	Friction Loss Pounds Per Square Inch	Velocity Feet Per Second	Friction Head Feet	Friction Loss Pounds Per Square Inch	Velocity Feet Per Second	Friction Head Feet	Friction Loss Pounds Per Square Inch	Velocity Feet Per Second	Friction Head Feet	Friction Loss Pounds Per Square Inch	Velocity Feet Per Second	Friction Head Feet	Friction Loss Pounds Per Square Inch	Velocity Feet Per Second	Friction Head Feet	Friction Loss Pounds Per Square Inch	Velocity Feet Per Second	Friction Head Feet	Friction Loss Pounds Per Square Inch
1	1.13	2.08	0.90	0.63	0.51	0.22	0.77	0.55	0.24	0.14	0.06	0.03	0.49	0.066	0.029	0.30	0.038	0.016	0.22	0.015	0.007			
2	2.26	4.16	1.80	1.26	1.02	0.44	1.53	1.11	0.46	0.44	0.19	0.09	0.81	0.22	0.09	0.61	0.07	0.03	0.44	0.031	0.015			
5	5.64	23.44	10.15	3.16	5.73	2.48	4.23	3.17	1.37	0.81	0.35	0.27	1.93	0.38	0.17	1.49	0.11	0.048	1.11	0.051	0.023			
7	7.90	43.06	18.64	4.43	10.52	4.56	5.72	4.37	2.01	1.11	0.51	0.38	2.69	0.51	0.24	2.01	0.15	0.066	1.55	0.069	0.039			
10	11.28	82.02	35.51	6.32	20.04	8.68	8.06	6.02	2.61	1.55	0.67	0.51	3.62	0.72	0.31	2.86	0.21	0.091	2.11	0.091	0.059			
15				9.48	42.46	18.39	11.58	12.77	5.53	3.28	1.42	0.66	5.44	1.03	0.42	4.23	0.45	0.19	3.03	0.19	0.082			
20	0.51	0.03	0.013	12.65	72.34	31.32	15.52	21.75	9.42	5.59	2.42	0.85	7.72	1.42	0.50	6.04	0.76	0.33	4.13	0.32	0.14			
25	0.64	0.04	0.017				19.95	32.88	14.22	8.45	3.66	1.13	9.65	1.71	0.50	7.27	1.15	0.42	5.00	0.42	0.17			
30	0.77	0.06	0.026	0.49	0.02	0.009		46.08	19.95	6.63	5.13	1.50	11.58	2.39	0.70	8.45	1.62	0.50	6.04	0.50	0.22			
35	0.89	0.08	0.035	0.57	0.03	0.013				7.73	6.82	2.01	13.21	3.19	0.93	9.65	2.15	0.68	7.27	0.68	0.29			
40	1.02	0.11	0.048	0.65	0.03	0.017				11.85	8.74	2.73	15.76	4.08	1.19	11.05	2.75	0.93	8.45	0.93	0.31			
45	1.15	0.13	0.056	0.73	0.04	0.022				20.18	10.87	3.62	25.10	5.08	1.49	13.21	3.43	1.19	10.87	1.19	0.40			
50	1.28	0.16	0.069	0.81	0.05	0.026				30.51	13.21	4.85	35.51	6.17	1.80	17.79	4.39	1.49	14.42	1.49	0.50			
60	1.53	0.22	0.095	0.97	0.07	0.030	0.56	0.02	0.009	11.05	13.21	6.17	45.51	8.65	2.53	21.79	5.84	2.01	19.95	2.01	0.62			
70	1.79	0.30	0.13	1.14	0.10	0.043	0.67	0.03	0.013			8.65	55.51	11.05	3.36	28.65	7.76	2.73	25.10	2.73	0.85			
75	1.92	0.34	0.15	1.22	0.11	0.048	0.79	0.04	0.017			9.70	65.51	13.21	4.30	35.51	8.82	3.31	30.51	3.31	1.00			
80	2.05	0.38	0.16	1.30	0.13	0.056	0.84	0.05	0.022			10.87	75.51	15.76	5.13	40.87	9.94	3.98	35.51	3.98	1.13			
90	2.30	0.47	0.20	1.46	0.16	0.069	0.90	0.05	0.026			12.65	85.51	18.39	6.17	46.08	11.05	4.63	40.87	4.63	1.28			
100	2.56	0.58	0.25	1.62	0.19	0.082	1.01	0.06	0.035			14.22	95.51	21.75	7.27	51.32	12.65	5.44	46.08	5.44	1.43			
125	3.20	0.88	0.38	2.03	0.29	0.125	1.41	0.12	0.052			18.39	126.51	31.32	10.87	65.51	16.61	7.27	58.45	7.27	1.80			
150	3.84	1.22	0.53	2.44	0.40	0.17	1.69	0.16	0.069			21.75	157.61	40.87	13.21	80.65	20.18	9.75	72.34	9.75	2.26			
175	4.48	1.63	0.71	2.84	0.54	0.235	1.97	0.22	0.096			25.10	188.71	50.87	15.76	95.51	25.10	12.65	86.51	12.65	2.73			
200	5.11	2.08	0.90	3.25	0.69	0.30	2.25	0.28	0.12			28.65	219.81	60.87	18.39	110.87	30.51	15.76	101.87	15.76	3.31			
250	6.40	3.15	1.36	4.06	1.05	0.45	2.81	0.43	0.19			35.51	286.51	80.65	23.44	142.22	38.62	21.75	126.51	21.75	4.13			
300	7.67	4.41	1.91	4.87	1.46	0.63	3.37	0.60	0.26			42.34	352.22	100.65	28.65	173.44	46.08	25.10	151.87	25.10	5.00			
350	8.95	5.87	2.55	5.69	1.95	0.85	3.94	0.79	0.34			50.87	418.95	120.65	33.62	205.10	51.32	30.51	177.99	30.51	5.84			
400	10.23	7.52	3.26	6.50	2.49	1.08	4.49	1.01	0.44			60.87	485.65	140.65	40.87	236.51	58.45	35.51	203.44	35.51	6.61			
450				7.31	3.09	1.34	5.06	1.26	0.55			70.65	552.34	160.65	50.87	267.99	66.17	40.87	230.10	40.87	7.48			
500				8.12	3.76	1.63	5.62	1.53	0.66			80.65	619.03	180.65	60.87	298.99	74.82	46.08	256.51	46.08	8.35			
750							8.43	3.25	1.41			101.87	755.65	220.65	70.65	330.10	82.65	51.32	282.99	51.32	9.22			
1000							11.24	5.54	2.40			122.65	892.34	260.65	80.65	361.87	90.65	56.61	308.99	56.61	10.09			
1250																								
1500																								
2000																								
2500																								
3000																								
3500																								
4000																								
4500																								
5000																								
5500																								
6000																								
6500																								
7000																								
7500																								
8000																								
8500																								
9000																								
9500																								
10000																								

# FRICION LOSS AND FLOW VELOCITY FOR SCHEDULE 80 THERMOPLASTIC PIPE

(Friction head and friction loss are per 100 feet of pipe.)

CAUTION: Flow velocity should not exceed 5 feet per second. PVC and CPVC pipe cannot be used for compressed air service.

Gallons Per Minute	1/2 in.	3/4 in.	1 in.	1 1/4 in.	2 in.	2 1/2 in.	3 in.	12 in.	14 in.	16 in.
1	1.48	4.02	1.74	0.37	0.86	0.37	0.37	0.009		
2	2.95	8.03	3.48	0.74	1.72	0.74	0.74	0.012		
5	7.39	45.23	19.59	4.19	9.67	4.19	4.19	0.017		
7	10.34	83.07	35.97	7.69	17.76	7.69	7.69	0.022		
10			4.68	11.76	33.84	14.65	14.65	0.028		
15			7.01	20.36	51.27	21.97	21.97	0.035		
20	0.57	0.04	9.35	34.68	77.00	31.82	31.82	0.042		
25	0.72	0.06	11.69	52.43	118.00	47.76	47.76	0.050		
30	0.86	0.08	14.03	73.48	164.00	66.67	66.67	0.058		
35	1.00	0.11	16.37	97.97	225.00	90.00	90.00	0.067		
40	1.15	0.14	18.70	125.55	300.00	117.00	117.00	0.077		
45	1.29	0.17	21.03	156.11	390.00	153.00	153.00	0.088		
50	1.43	0.21	23.36	189.66	500.00	198.00	198.00	0.100		
60	1.72	0.30	30.45	252.00	675.00	267.00	267.00	0.125		
70	2.01	0.39	37.54	324.00	900.00	360.00	360.00	0.150		
75	2.15	0.45	40.88	351.00	990.00	396.00	396.00	0.160		
80	2.29	0.50	44.22	378.00	1080.00	432.00	432.00	0.170		
90	2.58	0.63	54.27	459.00	1350.00	540.00	540.00	0.210		
100	2.87	0.76	64.32	540.00	1620.00	648.00	648.00	0.250		
125	3.59	1.16	80.40	675.00	2025.00	810.00	810.00	0.312		
150	4.30	1.61	96.48	810.00	2430.00	972.00	972.00	0.375		
175	5.02	2.15	112.56	945.00	2835.00	1134.00	1134.00	0.438		
200	5.73	2.75	128.64	1080.00	3240.00	1296.00	1296.00	0.500		
250	7.16	4.16	160.80	1350.00	4050.00	1620.00	1620.00	0.625		
300	8.60	5.83	192.96	1620.00	4860.00	1944.00	1944.00	0.750		
350	10.03	7.76	225.12	1890.00	5670.00	2268.00	2268.00	0.875		
400	11.47	9.93	257.28	2160.00	6480.00	2592.00	2592.00	1.000		
450			289.44	2430.00	7290.00	2916.00	2916.00	1.125		
500			321.60	2700.00	8100.00	3240.00	3240.00	1.250		
750			482.40	4050.00	12150.00	4860.00	4860.00	1.875		
1000			643.20	5400.00	16200.00	6480.00	6480.00	2.500		
1250			804.00	6750.00	20250.00	8100.00	8100.00	3.125		
1500			964.80	8100.00	24300.00	9720.00	9720.00	3.750		
2000			1286.40	10800.00	32400.00	12960.00	12960.00	5.000		
2500			1608.00	13500.00	40500.00	16200.00	16200.00	6.250		
3000			1929.60	16200.00	48600.00	19440.00	19440.00	7.500		
3500			2251.20	18900.00	56700.00	22680.00	22680.00	8.750		
4000			2572.80	21600.00	64800.00	25920.00	25920.00	10.000		
4500			2894.40	24300.00	72900.00	29160.00	29160.00	11.250		
5000			3216.00	27000.00	81000.00	32400.00	32400.00	12.500		
5500			3537.60	29700.00	89100.00	35640.00	35640.00	13.750		
6000			3859.20	32400.00	97200.00	38880.00	38880.00	15.000		
6500			4180.80	35100.00	105300.00	42120.00	42120.00	16.250		
7000			4502.40	37800.00	113400.00	45360.00	45360.00	17.500		
7500			4824.00	40500.00	121500.00	48600.00	48600.00	18.750		
8000			5145.60	43200.00	129600.00	51840.00	51840.00	20.000		
8500			5467.20	45900.00	137700.00	55080.00	55080.00	21.250		
9000			5788.80	48600.00	145800.00	58320.00	58320.00	22.500		
9500			6110.40	51300.00	153900.00	61560.00	61560.00	23.750		
10000			6432.00	54000.00	162000.00	64800.00	64800.00	25.000		

DESIGN & ENGINEERING DATA



# FRICITION LOSS AND FLOW VELOCITY FOR SDR 26 THERMOPLASTIC PIPE

(Friction head and friction loss are per 100 feet of pipe.)

CAUTION: Flow velocity should not exceed 5 feet per second. PVC and CPVC pipe cannot be used for compressed air service.

Gallons Per Minute	1/2 in.			3/4 in.			1 in.			1 1/4 in.			1 1/2 in.			2 in.			2 1/2 in.			3 in.				
	Velocity Feet Per Second	Friction Head Feet	Friction Loss Pounds Per Square Inch	Velocity Feet Per Second	Friction Head Feet	Friction Loss Pounds Per Square Inch	Velocity Feet Per Second	Friction Head Feet	Friction Loss Pounds Per Square Inch	Velocity Feet Per Second	Friction Head Feet	Friction Loss Pounds Per Square Inch	Velocity Feet Per Second	Friction Head Feet	Friction Loss Pounds Per Square Inch	Velocity Feet Per Second	Friction Head Feet	Friction Loss Pounds Per Square Inch	Velocity Feet Per Second	Friction Head Feet	Friction Loss Pounds Per Square Inch	Velocity Feet Per Second	Friction Head Feet	Friction Loss Pounds Per Square Inch		
1	0.84	1.00	0.43	0.50	0.28	0.12	0.59	0.29	0.13	0.085	0.36	0.27	0.02	0.0087	0.17	0.01	0.004	0.20	0.025	0.011	0.30	0.025	0.011	0.42	0.035	0.015
2	1.67	2.00	0.86	0.99	0.56	0.24	1.48	0.91	0.39	0.27	0.90	0.68	0.14	0.059	0.44	0.045	0.020	0.28	0.056	0.026	0.88	0.056	0.026	0.88	0.13	0.056
5	4.17	11.25	4.87	2.47	3.14	1.36	2.08	1.66	0.72	0.49	1.25	0.96	0.25	0.104	0.61	0.08	0.035	0.42	0.035	0.015	0.59	0.06	0.026	0.59	0.06	0.026
7	5.84	20.66	8.95	3.46	5.76	2.49	2.96	3.16	1.37	0.92	1.79	1.36	0.47	0.20	0.87	0.16	0.069	0.42	0.035	0.015	0.88	0.13	0.056	0.88	0.13	0.056
10	8.34	39.34	17.03	4.94	10.96	4.74	4.44	6.69	2.90	1.96	2.68	2.04	1.00	0.43	1.30	0.33	0.14	0.88	0.13	0.056	1.18	0.22	0.095	1.18	0.22	0.095
15				7.40	23.23	10.06	5.92	11.40	4.94	3.34	3.58	3.45	1.71	0.74	1.73	0.57	0.25	1.18	0.22	0.095	1.47	0.34	0.15	1.47	0.34	0.15
20				9.87	39.57	17.13	7.40	17.23	7.46	5.04	4.47	5.04	2.59	1.12	2.16	0.86	0.37	1.47	0.34	0.15	1.77	0.47	0.20	1.77	0.47	0.20
25				0.47	0.02	0.009	8.88	24.15	10.46	7.07	5.36	4.08	3.63	1.57	2.60	1.21	0.52	1.77	0.47	0.20	2.06	0.63	0.27	2.06	0.63	0.27
30				0.55	0.03	0.013	10.36	32.13	13.91	8.04	6.26	4.76	4.76	2.09	3.03	1.61	0.70	2.35	0.81	0.35	2.35	0.81	0.35	2.35	0.81	0.35
35				0.63	0.03	0.013	11.05	33.13	14.91	8.94	7.15	5.22	5.44	2.68	3.46	2.06	0.89	2.65	1.00	0.43	2.65	1.00	0.43	2.65	1.00	0.43
40				0.71	0.04	0.017	11.05	33.13	14.91	8.94	7.15	5.22	5.44	2.68	3.46	2.06	0.89	2.65	1.00	0.43	2.65	1.00	0.43	2.65	1.00	0.43
45				0.78	0.05	0.022	11.05	33.13	14.91	8.94	7.15	5.22	5.44	2.68	3.46	2.06	0.89	2.65	1.00	0.43	2.65	1.00	0.43	2.65	1.00	0.43
50				0.94	0.07	0.030	11.05	33.13	14.91	8.94	7.15	5.22	5.44	2.68	3.46	2.06	0.89	2.65	1.00	0.43	2.65	1.00	0.43	2.65	1.00	0.43
60				1.10	0.09	0.039	11.05	33.13	14.91	8.94	7.15	5.22	5.44	2.68	3.46	2.06	0.89	2.65	1.00	0.43	2.65	1.00	0.43	2.65	1.00	0.43
70				1.25	0.12	0.052	11.05	33.13	14.91	8.94	7.15	5.22	5.44	2.68	3.46	2.06	0.89	2.65	1.00	0.43	2.65	1.00	0.43	2.65	1.00	0.43
80				1.41	0.14	0.061	11.05	33.13	14.91	8.94	7.15	5.22	5.44	2.68	3.46	2.06	0.89	2.65	1.00	0.43	2.65	1.00	0.43	2.65	1.00	0.43
90				1.57	0.18	0.078	11.05	33.13	14.91	8.94	7.15	5.22	5.44	2.68	3.46	2.06	0.89	2.65	1.00	0.43	2.65	1.00	0.43	2.65	1.00	0.43
100				1.74	0.22	0.104	11.05	33.13	14.91	8.94	7.15	5.22	5.44	2.68	3.46	2.06	0.89	2.65	1.00	0.43	2.65	1.00	0.43	2.65	1.00	0.43
125				2.15	0.32	0.14	11.05	33.13	14.91	8.94	7.15	5.22	5.44	2.68	3.46	2.06	0.89	2.65	1.00	0.43	2.65	1.00	0.43	2.65	1.00	0.43
150				2.39	0.40	0.17	11.05	33.13	14.91	8.94	7.15	5.22	5.44	2.68	3.46	2.06	0.89	2.65	1.00	0.43	2.65	1.00	0.43	2.65	1.00	0.43
175				2.99	0.50	0.22	11.05	33.13	14.91	8.94	7.15	5.22	5.44	2.68	3.46	2.06	0.89	2.65	1.00	0.43	2.65	1.00	0.43	2.65	1.00	0.43
200				3.59	0.63	0.27	11.05	33.13	14.91	8.94	7.15	5.22	5.44	2.68	3.46	2.06	0.89	2.65	1.00	0.43	2.65	1.00	0.43	2.65	1.00	0.43
250				4.79	0.77	0.34	11.05	33.13	14.91	8.94	7.15	5.22	5.44	2.68	3.46	2.06	0.89	2.65	1.00	0.43	2.65	1.00	0.43	2.65	1.00	0.43
300				5.98	0.96	0.42	11.05	33.13	14.91	8.94	7.15	5.22	5.44	2.68	3.46	2.06	0.89	2.65	1.00	0.43	2.65	1.00	0.43	2.65	1.00	0.43
350				7.18	1.16	0.58	11.05	33.13	14.91	8.94	7.15	5.22	5.44	2.68	3.46	2.06	0.89	2.65	1.00	0.43	2.65	1.00	0.43	2.65	1.00	0.43
400				8.38	1.41	0.77	11.05	33.13	14.91	8.94	7.15	5.22	5.44	2.68	3.46	2.06	0.89	2.65	1.00	0.43	2.65	1.00	0.43	2.65	1.00	0.43
450				9.57	1.71	1.04	11.05	33.13	14.91	8.94	7.15	5.22	5.44	2.68	3.46	2.06	0.89	2.65	1.00	0.43	2.65	1.00	0.43	2.65	1.00	0.43
500				10.77	2.02	1.35	11.05	33.13	14.91	8.94	7.15	5.22	5.44	2.68	3.46	2.06	0.89	2.65	1.00	0.43	2.65	1.00	0.43	2.65	1.00	0.43
750				11.96	2.33	1.66	11.05	33.13	14.91	8.94	7.15	5.22	5.44	2.68	3.46	2.06	0.89	2.65	1.00	0.43	2.65	1.00	0.43	2.65	1.00	0.43
1000							11.05	33.13	14.91	8.94	7.15	5.22	5.44	2.68	3.46	2.06	0.89	2.65	1.00	0.43	2.65	1.00	0.43	2.65	1.00	0.43
1250							11.05	33.13	14.91	8.94	7.15	5.22	5.44	2.68	3.46	2.06	0.89	2.65	1.00	0.43	2.65	1.00	0.43	2.65	1.00	0.43
1500							11.05	33.13	14.91	8.94	7.15	5.22	5.44	2.68	3.46	2.06	0.89	2.65	1.00	0.43	2.65	1.00	0.43	2.65	1.00	0.43
2000							11.05	33.13	14.91	8.94	7.15	5.22	5.44	2.68	3.46	2.06	0.89	2.65	1.00	0.43	2.65	1.00	0.43	2.65	1.00	0.43
2500							11.05	33.13	14.91	8.94	7.15	5.22	5.44	2.68	3.46	2.06	0.89	2.65	1.00	0.43	2.65	1.00	0.43	2.65	1.00	0.43
3000							11.05	33.13	14.91	8.94	7.15	5.22	5.44	2.68	3.46	2.06	0.89	2.65	1.00	0.43	2.65	1.00	0.43	2.65	1.00	0.43
3500							11.05	33.13	14.91	8.94	7.15	5.22	5.44	2.68	3.46	2.06	0.89	2.65	1.00	0.43	2.65	1.00	0.43	2.65	1.00	0.43
4000							11.05	33.13	14.91	8.94	7.15	5.22	5.44	2.68	3.46	2.06	0.89	2.65	1.00	0.43	2.65	1.00	0.43	2.65	1.00	0.43
4500							11.05	33.13	14.91	8.94	7.15	5.22	5.44	2.68	3.46	2.06	0.89	2.65	1.00	0.43	2.65	1.00	0.43	2.65	1.00	0.43

DESIGN & ENGINEERING DATA

# FRICION LOSS AND FLOW VELOCITY FOR SDR 11 CTS CPVC THERMOPLASTIC PIPE

(Friction head and friction loss are per 100 feet of pipe.)

CAUTION: Flow velocity should not exceed 5 feet per second. PVC and CPVC pipe cannot be used for compressed air service.

Gallons Per Minute	1/2 in.			3/4 in.			1 in.			1 1/4 in.			1 1/2 in.			2 in.		
	Velocity Feet Per Second	Head Loss Feet of Water Per 100 Ft.	Pressure Loss PSI Per 100 Ft.	Velocity Feet Per Second	Head Loss Feet of Water Per 100 Ft.	Pressure Loss PSI Per 100 Ft.	Velocity Feet Per Second	Head Loss Feet of Water Per 100 Ft.	Pressure Loss PSI Per 100 Ft.	Velocity Feet Per Second	Head Loss Feet of Water Per 100 Ft.	Pressure Loss PSI Per 100 Ft.	Velocity Feet Per Second	Head Loss Feet of Water Per 100 Ft.	Pressure Loss PSI Per 100 Ft.	Velocity Feet Per Second	Head Loss Feet of Water Per 100 Ft.	Pressure Loss PSI Per 100 Ft.
1	1.71	3.19	1.38	0.80	0.50	0.22	0.48	0.15	0.06	1.61	1.09	0.47	1.16	0.49	0.21	0.68	0.13	0.06
2	3.42	11.53	5.00	1.60	1.82	0.79	0.96	0.53	0.23	3.23	3.94	1.71	2.31	1.75	0.76	1.35	0.49	0.21
3	5.13	24.43	10.59	2.40	3.85	1.67	1.44	1.12	0.49	4.84	8.35	3.62	3.47	3.71	1.61	2.03	1.03	0.45
4	6.83	41.62	18.04	3.20	6.55	2.84	1.93	1.91	0.83	6.46	14.23	6.17	4.63	6.33	2.74	2.70	1.76	0.76
5	8.54	62.91	27.27	4.00	9.91	4.29	2.41	2.89	1.25	8.07	21.51	9.33	5.78	9.56	4.15	3.38	2.66	1.15
6	10.25	88.18	38.23	4.79	13.89	6.02	2.89	4.05	1.76	9.68	30.15	13.07	6.94	13.40	5.81	4.05	3.73	1.62
7	11.96	117.32	50.86	5.59	18.47	8.01	3.37	5.39	2.34	11.30	40.11	17.39	8.09	17.83	7.73	4.73	4.96	2.15
8	13.67	150.23	65.13	6.39	23.66	10.26	3.85	6.90	2.99	12.91	51.37	22.27	9.25	22.83	9.90	5.40	6.35	2.75
9	15.38	186.85	81.00	7.19	29.42	12.76	4.33	8.58	3.72	14.52	63.89	27.70	10.41	28.40	12.31	6.08	7.89	3.42
10	17.08	227.11	98.45	7.99	35.76	15.50	4.82	10.43	4.52	16.14	77.66	33.66	11.56	34.52	14.96	6.75	9.60	4.16
15				11.99	75.78	32.85	7.22	22.11	9.58	17.75	92.65	40.16	12.72	41.18	17.85	7.43	11.45	4.96
20				15.98	129.11	55.97	9.63	37.67	16.33	18.88	106.19	46.03	13.88	48.38	20.97	8.10	13.45	5.83
25							12.04	56.94	24.69				16.19	64.37	27.90	9.46	17.89	7.76
30							14.45	79.82	34.60									
35							16.86	106.19	46.03									
40																		
45																		
50																		
55																		
60																		
70																		
80																		
90																		
100																		
125																		



# SUPPORT SPACING FOR ABS AND PVC PIPE

## Support and Spacing

Adequate support for any piping system is a matter of great importance. In practice, support spacings are a function of pipe size, operating temperatures, the location of heavy valves or fittings, and the mechanical properties of the pipe material.

To ensure the satisfactory operation of a DWV or pressure piping system, the location and type of hangers should be carefully considered. The principles of design for steel piping systems are generally also applicable to DWV or pressure piping systems, but with some notable areas where special consideration should be exercised. Metal hangers are recommended. Hangers should not compress, distort, cut or abrade the piping.

All piping should be supported with an approved hanger at intervals sufficiently close to maintain correct pipe alignment and to prevent sagging or grade reversal. Pipe should also be supported at all branch ends and at all changes of direction. Support trap arms as close as possible to the trap. In keeping with good plumbing practices, support and brace all closet bends and fasten closet flanges.

- (1) Concentrated loads should be supported directly so as to eliminate high stress concentrations. Should this be impractical, then the pipe must be supported immediately adjacent to the load.
- (2) In systems where large fluctuations in temperature occur, allowances must be made for expansion and contraction of the piping system. Since changes in direction in the system are usually sufficient to allow for expansion and contraction, hangers must be placed so as not to restrict this movement.
- (3) Since plastic pipe expand or contracts approximately five times greater than steel, hangers should not restrict this movement. When using a clamp-type hanger, the hanger should not force the pipe and fittings into position.
- (4) Hangers should provide as much bearing surface as possible. To prevent damage to the pipe, file smooth any sharp edges or burrs on the hangers or supports.
- (5) Plastic piping systems must not be placed alongside steam or other high temperature pipe lines or other high temperature objects.
- (6) Support spacing for horizontal piping systems is determined by the maximum operating temperature the system will encounter. The piping should be supported on uniform centers with supports that do not restrict the axial movement.
- (7) For vertical lines, it is recommended that an engineer design the vertical supports according to the vertical load involved.
- (8) Changes in direction should be supported as close as practical to the fitting to avoid introducing excessive torsional stresses into the system. The following chart shows the recommended support spacing according to size, schedule, and operating temperatures. These spacings apply to continuous spans of uninsulated lines, with no concentrated loads, conveying liquids with specific gravities of up to 1.00.

NOTE: The above information provides general guidelines. It should be used only as a reference and not as a guarantee of performance. Specific installation instructions and techniques may be required as a result of local plumbing and building codes, engineering specifications and instructions.

# SUPPORT SPACING FOR ABS, PVC AND CPVC PIPE

## Recommended Support Spacing (in feet)

Nom. Pipe Size (in.)	PVC PIPE															ABS PIPE					
	SDR 21 PR200 & SDR 26 PR160					Schedule 40					Schedule 80					Schedule 40					
	Temp. °F					Temp. °F					Temp. °F					Temp. °F					
	60	80	100	120	140	60	80	100	120	140	60	80	100	120	140	60	80	100	120	140	160
1/2	3 1/2	3 1/2	3	2		4 1/2	4 1/2	4	2 1/2	2 1/2	5	4 1/2	4 1/2	3	2 1/2						
3/4	4	3 1/2	3	2		5	4 1/2	4	2 1/2	2 1/2	5 1/2	5	4 1/2	3	2 1/2						
1	4	4	3 1/2	2		5 1/2	5	4 1/2	3	2 1/2	6	5 1/2	5	3 1/2	3						
1 1/4	4	4	3 1/2	2 1/2		5 1/2	5 1/2	5	3	3	6	6	5 1/2	3 1/2	3						
1 1/2	4 1/2	4	4	2 1/2		6	5 1/2	5	3 1/2	3	6 1/2	6	5 1/2	3 1/2	3 1/2	6	6	5 1/2	3 1/2	3	3
2	4 1/2	4	4	3		6	5 1/2	5	3 1/2	3	7	6 1/2	6	4	3 1/2	6	6	5 1/2	3 1/2	3	3
2 1/2	5	5	4 1/2	3		7	6 1/2	6	4	3 1/2	7 1/2	7 1/2	6 1/2	4 1/2	4						
3	5 1/2	5 1/2	4 1/2	3		7	7	6	4	3 1/2	8	7 1/2	7	4 1/2	4	7	7	7	4	3 1/2	3 1/2
4	6	5 1/2	5	3 1/2		7 1/2	7	6 1/2	4 1/2	4	9	8 1/2	7 1/2	5	4 1/2	7 1/2	7 1/2	7	4 1/2	4	4
6	6 1/2	6 1/2	5 1/2	4		8 1/2	8	7 1/2	5	4 1/2	10	9 1/2	9	6	5	8 1/2	8 1/2	8	5	4 1/2	4 1/2
8	7	6 1/2	6	5		9	8 1/2	8	5	4 1/2	11	10 1/2	9 1/2	6 1/2	5 1/2						
10						10	9	8 1/2	5 1/2	5	12	11	10	7	6						
12						11 1/2	10 1/2	9 1/2	6 1/2	5 1/2	13	12	10 1/2	7 1/2	6 1/2						
14						12	11	10	7	6	13 1/2	13	11	8	7						
16						12 1/2	11 1/2	10 1/2	7 1/2	6 1/2	14	13 1/2	11 1/2	8 1/2	7 1/2						

NOTE: Always follow local code requirements for hanger spacing.

## Recommended Support Spacing (in feet)

Nom. Pipe Size (in.)	CPVC PIPE					
	Schedule 80					
	Temp. °F					
	60	80	100	120	140	180
1/2	5 1/2	5 1/2	5	4 1/2	4 1/2	2 1/2
3/4	5 1/2	5 1/2	5 1/2	5	4 1/2	2 1/2
1	6	6	6	5 1/2	5	3
1 1/4	6 1/2	6 1/2	6	6	5 1/2	3
1 1/2	7	7	6 1/2	6	5 1/2	3 1/2
2	7	7	7	6 1/2	6	3 1/2
2 1/2	8	7 1/2	7 1/2	7 1/2	6 1/2	4
3	8	8	8	7 1/2	7	4
4	9	9	9	8 1/2	7 1/2	4 1/2
6	10	10 1/2	9 1/2	9	8	5
8	11	11	10 1/2	10	9	5 1/2
10	11 1/2	11 1/2	11	10 1/2	9 1/2	6
12	12 1/2	12 1/2	12 1/2	11	10 1/2	6 1/2

## Typical Pipe Hangers, Clamps, and Supports

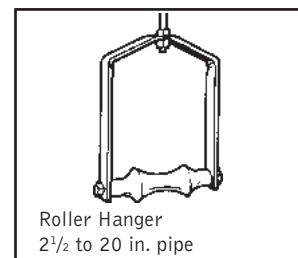
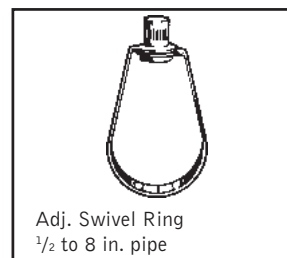
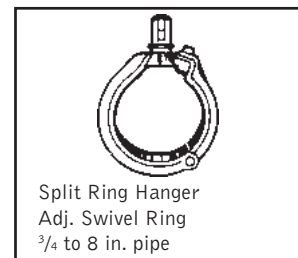
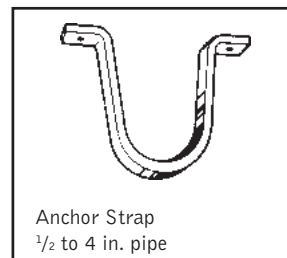
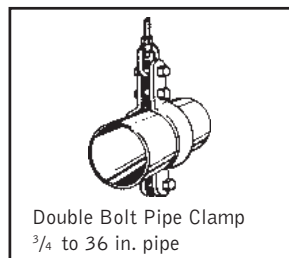

The pipe should not be anchored tightly by the support, but secured in a manner to allow for movement caused by thermal expansion and contraction. It is recommended that you use clamps or straps that allow pipe to remain away from the framing, thus reducing the noise generated when pipe is allowed to rub against wood.

# EXPANSION AND CONTRACTION OF ABS, PVC, AND CPVC

ABS, PVC and CPVC pipe, like other piping materials, undergo length changes as a result of temperature variations above and below the installation temperature. They expand and contract 4.5 to 5 times more than steel or iron pipe. The extent of the expansion or contraction is dependent upon the piping material's coefficient of linear expansion, the length of pipe between directional changes, and the temperature differential.

The coefficients of linear expansion (Y) for ABS, PVC, and CPVC (expressed in inches of expansion per 10°F temperature change per 100 feet of pipe) are as follows:

Material	Y (in./10°F/100 ft)
ABS	0.66
PVC	0.36
CPVC	0.408

The amount of expansion or contraction can be calculated using the following formula:

$$e = \frac{Y (T_1 - T_2) \times L_p}{10 \times 100}$$

e = Dimensional change due to thermal expansion or contraction (in.)

Y = Expansion coefficient (See table above.) (in./10°F/100 ft)

(T<sub>1</sub>-T<sub>2</sub>) = Temperature differential between the installation temperature and the maximum or minimum system temperature, whichever provides the greatest differential (°F).

L<sub>p</sub> = Length of pipe run between changes in direction (ft)

Example: How much expansion (e) can be expected in a 60 foot straight run of 2" diameter PVC pipe installed at 70°F and operating at 120°F?

Solution:

$$e = .360 \frac{(120 - 70) \times 60}{10 \times 100} = .360 \times 5 \times .6 = 1.08 \text{ inches}$$

There are several ways to compensate for expansion and contraction. The most common methods are:

1. Expansion Loops (Fig. 1)
2. Offsets (Fig. 2)
3. Change in direction (Fig. 3)
4. Piston type expansion joints\* (Fig. 4)
5. Bellows and/or rubber expansion joints\*
6. Flexible Bends\*

\*The manufacturers of these devices should be contacted to determine the suitability of their products for the specific application.

When installing the expansion loop, no rigid or restraining supports should be placed within the leg lengths of the loop. The loop should be installed as closely as possible to the mid-point between anchors. Piping support guides should restrict lateral movement and direct axial movement into the loop. Lastly, the pipe and fittings should be solvent cemented together, rather than using threaded connections.

**Modulus of Elasticity & Working Stress**  
**Table 1**

	ABS		PVC		CPVC	
	Modulus of Elasticity (psi)	Working Stress (psi)	Modulus of Elasticity (psi)	Working Stress (psi)	Modulus of Elasticity (psi)	Working Stress (psi)
73° F	250,000	N/A	420,000	2,000	370,000	2,000
90° F	240,000	N/A	380,000	1,500	360,000	1,820
100° F	230,000	N/A	350,000	1,240	350,000	1,640
120° F	215,000	N/A	300,000	800	340,000	1,300
140° F	195,000	N/A	200,000	400	325,000	1,000
160° F	180,000	N/A	N/A	N/A	310,000	800
180° F	N/A	N/A	N/A	N/A	290,000	500

Modulus Data is Modulus of Elasticity in Tension per ASTM D 638

## Expansion Loop Formula

$$L = \sqrt{\frac{3 ED (\Delta L)}{2S}}$$

Where:

L = Loop length (in.)

E = Modulus of elasticity at maximum temperature (psi) (Table 1)

S = Working Stress at maximum temperature (psi) (Table 1)

D = Outside diameter of pipe (in.) (pages 20-30)

ΔL = Change in length due to change in temperature (in.)

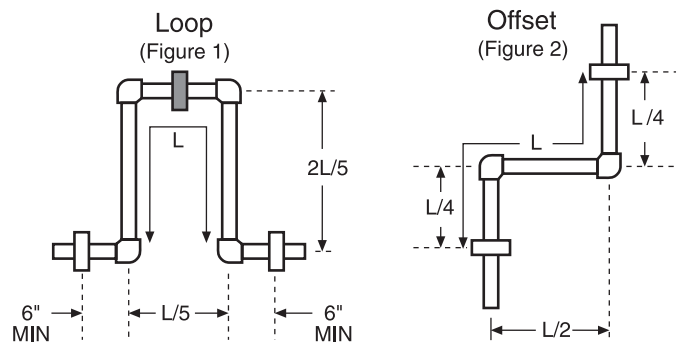

**Change of Direction**  
**(Figure 3)**

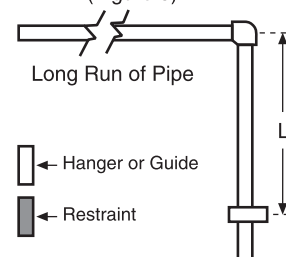

## Thermal Expansion in DWV Systems

Secure above-ground vertical DWV or storm-drainage piping at sufficiently close intervals to maintain proper alignment and to support the weight of the piping and its contents. Support stack at base, and if over two stories in height, support stack at base and at each floor with approved riser clamps. Stacks should be anchored so that movement is directed to the offset or expansion joint. For verticle stacks in multi-story applications, compensation for expansion, contraction or building settling is recommended. This can be accomplished by installing a horizontal offset (Fig. 2) or expansion joint (Fig. 4) at a minimum of every other floor. Expansion joints should be installed in the neutral position. Compensation for thermal movements is usually not required for a vent system.

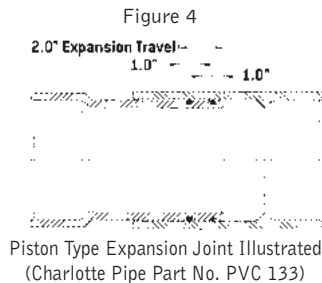

## Thermal Expansion in Underground Systems

Compensation for expansion and contraction in underground applications is normally achieved by snaking the pipe in the trench. Solvent cemented joints must be used.

The following table shows recommended offsets and loop lengths for piping up to 2 1/2" nominal size.

Loop Length In Feet	Max. Temp. Variation °F, Between Installation and Final Operation									
	10°	20°	30°	40°	50°	60°	70°	80°	90°	100°
20	3.0	3.5	4.5	5.0	6.0	6.5	7.0	7.0	8.0	8.0
50	7.0	9.0	11.0	13.0	14.0	15.5	17.0	18.0	19.0	20.0
100	13.0	18.0	22.0	26.0	29.0	31.5	35.0	37.0	40.0	42.0

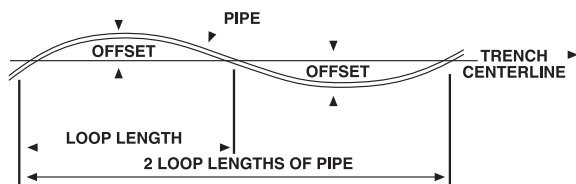

## Trenching

The following trenching and burial procedures should be used to protect the piping system.

1. The trench should be excavated to ensure the sides will be stable under all working conditions.
2. The trench should be wide enough to provide adequate room for the following.

- A. Joining the pipe in the trench.
- B. Snaking the pipe from side to side to compensate for expansion and contraction.
- C. Filling and compacting the side fills.

The space between the pipe and trench wall must be wider than the compaction equipment used in the compaction of the backfill. Minimum width shall be not less than the greater of either the pipe outside diameter plus 16 inches or the pipe outside diameter times 1.25 plus 12 inches. Trench width may be different if approved by the design engineer.

3. The trench bottom should be smooth, free of rocks and debris, continuous, and provide uniform support. If ledge rock, hardpan or large boulders are encountered, the trench bottom should be padded with bedding of compacted aggregate material to a thickness of at least 4 inches. Foundation bedding should be installed as required by the engineer.
4. Trench depth is determined by the pipe's service requirements. Plastic pipe should always be installed at least below the frost level. The minimum cover for lines subject to heavy overhead traffic is 24 inches.
5. A smooth, trench bottom is necessary to support the pipe over its entire length on firm stable material. Blocking should not be used to change pipe grade or to intermittently support pipe over low sections in the trench.

## Bedding and Backfilling

1. Even though sub-soil conditions vary widely from place to place, the pipe backfill should be stable and provide protection for the pipe.
2. The pipe should be surrounded with an aggregate material which is easily worked around the sides of the pipe. Backfilling should be performed in layers of 6 inch with each layer being sufficiently compacted to 85% to 95% compaction.
3. A mechanical tamper is recommended for compacting sand and gravel backfill which contain a significant proportion of fine grained material, such as silt and clay. If a tamper is not available, compacting should be done by hand.
4. The trench should be completely filled. The backfill should be placed and spread in fairly uniform layers to prevent any unfilled spaces or voids. Large rocks, stones, frozen clods, or other large debris should be removed.

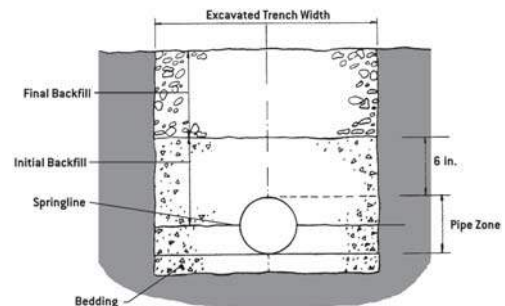

Heavy tampers or rolling equipment should only be used to consolidate only the final backfill.

Additional information is contained in ASTM D 2321 "Underground Installation of Thermoplastic pipe for Sewers and Other Gravity-Flow Applications" (non-pressure applications) and in ASTM F 1668 "Construction Procedures for Buried Plastic Pipe."

## Installation Procedures for ABS, PVC and CPVC Piping Systems

With our reliable, easy-to-install ABS, PVC and CPVC TrueFit systems, Charlotte Pipe and Foundry is doing more than any other supplier to help contractors work more efficiently and productively.

The following information contains suggested installation and testing procedures and does not encompass all of the requirements for the design or installation of a piping system.

- Observe all safety precautions.
- Systems should be installed in a good and workmanlike manner consistent with normal industry standards and in conformance with all local plumbing, fire and building code requirements. Failure to follow proper installation practices, procedures, or techniques can result in system failure, property damage, or personal injury.
- Pipe and fitting systems should be used for their intended purpose as defined by local plumbing and building codes and the applicable ASTM standard.
- Follow manufacturers' instructions for all related products.

### 1. Cut Pipe

- Cut pipe square. As joints are sealed at the base of the fitting hub. An angled cut may result in joint failure.
- Acceptable tools include miter saw, mechanical cut off saw or wheel cutter. Wheel type cutters must employ a blade designed for plastics.



### 2. Remove Burr And Bevel

- Remove all pipe burr from inside and outside diameter of pipe with a knife-edge, file, or deburring tool.
- Chamfer (bevel) the end of the pipe 10° -15° as shown to the right.



### 3. Clean and Dry Pipe and Fittings

- Remove surface dirt, grease, or moisture with a clean dry cloth.

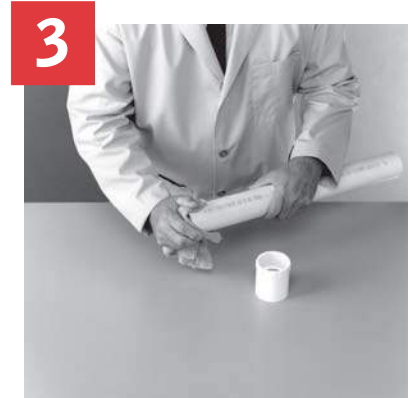

### 4. Dry Fit

- With light pressure, pipe should go one half to one third of the way into the fitting hub. Pipe and fittings that are too tight or too loose should not be used.



### 5. Applicator

- Use an applicator that is one half the pipe diameter.
- Too large an applicator will force excessive cement into the inside of small diameter fittings. Too small an applicator will not apply sufficient cement to large diameter systems.



Nominal Pipe Size (in.)	Applicator Type		
	Dauber	Brush Width (in.)	Roller Length (in.)
1/4	A	1/2	NR
3/8	A	1/2	NR
1/2	A	1/2	NR
3/4	A	1	NR
1	A	1	NR
1 1/4	A	1	NR
1 1/2	A	1 - 1 1/2	NR
2	A	1 - 1 1/2	NR
2 1/2	NR	1 1/2 - 2	NR
3	NR	1 1/2 - 2 1/2	NR
4	NR	2 - 3	3
5	NR	3 - 5	3
6	NR	3 - 5	3
8	NR	4 - 6	7
10	NR	6 - 8	7
12	NR	6 - 8	7
14	NR	7 - 8	7
16	NR	8+	8

A = Acceptable

NR = Not Recommended

## 6. Coat Surfaces with Primer and Cement



- Apply primer to PVC and CPVC pipe and fitting surfaces. Do not allow primer to puddle inside the system. Primer should conform to ASTM F 656. The use of primer for ABS is not recommended.
- Apply a full even layer of cement on the pipe O.D. for a distance slightly greater than the depth of the socket of the fitting.
- Coat the fitting socket with a medium layer of cement, avoiding puddling inside the system. Apply a second full even layer of cement on the pipe O.D. Solvent cement should meet ASTM D 2564 for PVC systems, ASTM F 493 for CPVC systems, and ASTM D 2235 for ABS systems.

## 7. Join Pipe and Fittings

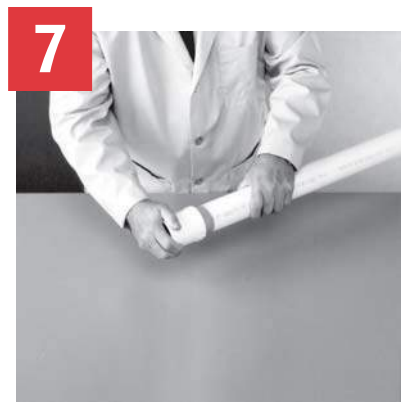

- Assemble pipe and fittings quickly while cement is fluid.
- Insert pipe into fitting hub until it contacts socket bottom. Give pipe a quarter turn. Hold pipe and fitting together until the pipe does not back out.
- See table for recommended cure times.
- Remove excessive cement from the exterior. A properly made joint will show a continuous bead of cement around the perimeter.

## Threaded Joint

When combining plastic and metal threaded systems, it is recommended that plastic male threads be screwed into metal female threads rather than metal male threads into plastic female threads.

## Joint Curing

The joint should not be disturbed until it has initially set. The chart below shows the recommended initial set times.

### Recommended Initial Set Times

Temperature Range	Pipe Sizes 1/2" to 1 1/4"	Pipe Sizes 1 1/2" to 3"	Pipe Sizes 4" to 8"	Pipe Sizes 10" to 16"
60° - 100° F	15 min	30 min	1 hr	2 hr
40° - 60° F	1 hr	2 hr	4 hr	8 hr
0° - 40° F	3 hr	6 hr	12 hr	24 hr

The joint should not be pressure tested until it has cured. The exact curing time varies with temperature, humidity, and pipe size. The following chart shows suggested curing times.

### Recommended Curing Time Before Pressure Testing

RELATIVE HUMIDITY 60% or Less*	CURE TIME Pipe Sizes 1/2" to 1 1/4"		CURE TIME Pipe Sizes 1 1/2" to 3"		CURE TIME Pipe Sizes 4" to 8"		CURE TIME Pipe Sizes 10" to 16"
Temperature Range During Assembly and Cure Periods	Up to 180 psi	Above 180 to 370 psi	Up to 180 psi	Above 180 to 315 psi	Up to 180 psi	Above 180 to 315 psi	Up to 100 psi
60° - 100° F	1 hr	6 hr	2 hr	12 hr	6 hr	24 hr	24 hr
40° - 60° F	2 hr	12 hr	4 hr	24 hr	12 hr	48 hr	48 hr
0° - 40° F	8 hr	48 hr	16 hr	96 hr	48 hr	8 days	8 days

\*For relative humidity above 60%, allow 50% more cure time.

The above data are based on laboratory tests and are intended as guidelines.

For more specific information, contact should be made with the cement manufacturer.

### \*Average number of joints per Quart for Cement and Primer (Source: IPS Weld-on)

Pipe Diameter	1/2"	3/4"	1"	1-1/2"	2"	3"	4"	6"	8"	10"	12"	15"	18"
Number of Joints	300	200	125	90	60	40	30	10	5	2 to 3	1 to 2	3/4	1/2

For Primer: double the number of joints shown for cement.

\* These figures are estimates based on IPS Weld-on laboratory tests.

Due to many variables in the field, these figures should be used as a general guide only.

## Testing Pressure System

- Prior to testing, safety precautions should be instituted to protect personnel and property in case of test failure.
- Conduct pressure testing with water. DO NOT USE AIR OR OTHER GASES for pressure testing.
- The piping system should be adequately anchored to limit movement. Water under pressure exerts thrust forces in piping systems. Thrust blocking should be provided at changes of direction, change in size and at dead ends.
- The piping system should be slowly filled with water, taking care to prevent surge and air entrapment. The flow velocity should not exceed 5 feet per second (see charts on pages 37-41).
- All trapped air must be slowly released. Vents must be provided at all high points of the piping system. All valves and air relief mechanisms should be opened so that the air can be vented while the system is being filled. Trapped air is extremely dangerous and it must be slowly and completely vented prior to testing.
- Once an installation is completed and cured the system should be filled with water and pressure tested in accordance with local code requirements. However, care must be taken to ensure the pressure does not exceed the working pressure of the lowest component in the system (valves, unions, flanges, threaded parts, etc.)
- The pressure test should not exceed one hour. Any leaking joints or pipe must be cut out and replaced and the line recharged and retested using the same procedure.

# FLANGES AND UNIONS PVC AND CPVC PIPE

For systems where dismantling is required, flanging is a convenient joining method. It is also an easy way to join plastic and metallic systems.



- Use a torque wrench to tighten the bolts to the torque values shown below.



## Installation

- Join the flange to the pipe using the procedures shown in the solvent cementing or threading sections.
- Use a full faced elastomeric gasket which is resistant to the chemicals being conveyed in the piping system. A gasket 1/8" thick with a Durometer, scale "A", hardness of 55 -80 is normally satisfactory.
- Align the flanges and gasket by inserting all of the bolts through the mating flange bolt holes. Be sure to use properly sized flat washers under all bolt heads and nuts.
- Sequentially tighten the bolts corresponding to the patterns shown below.

## Recommended Torque

Pipe Size In Inches	No. Bolt Holes	Bolt Diameter	Recommended Torque ft/lbs
1/2	4	1/2	10 - 15
3/4	4	1/2	10 - 15
1	4	1/2	10 - 15
1 1/4	4	1/2	10 - 15
1 1/2	4	1/2	10 - 15
2	4	5/8	20 - 30
2 1/2	4	5/8	20 - 30
3	4	5/8	20 - 30
4	8	5/8	20 - 30
6	8	3/4	33 - 50
8	8	3/4	33 - 50
10	12	7/8	53 - 75
12	12	7/8	53 - 75

Note: Flanges meet the bolt-pattern requirements of ANSI / ASME B 16.5

## FLANGE BOLT TIGHTENING SEQUENCE

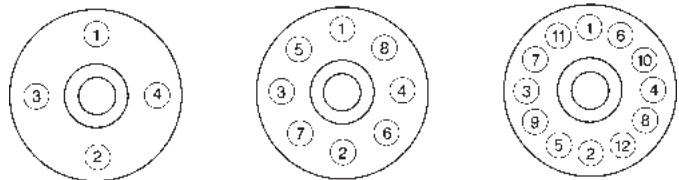

## Pressure Rating of PVC and CPVC Unions and Flanges at Elevated Temperatures

System Operating Temp. Temperature °F (C)		100 (38)	110 (43)	120 (49)	130 (54)	140 (60)	150 (66)	160 (71)	170 (77)	180 (82)	190 (88)	200 (93)	210 (99)	
Pressure Rating psi (Mpa)	1/2" - 2"	PVC	235 (1.62)	211 (1.45)	150 (1.03)	75 (.52)	50 (.34)	0 (0)	0 (0)	0 (0)	0 (0)	0 (0)	0 (0)	
		CPVC	235 (1.62)	219 (1.51)	170 (1.17)	145 (1.00)	130 (.90)	110 (.76)	90 (.62)	80 (.55)	70 (.48)	60 (.41)	50 (.34)	0 (0)
	2-1/2" - 6"	PVC	150 (1.03)	135 (.93)	110 (.76)	75 (.52)	50 (.34)	0 (0)	0 (0)	0 (0)	0 (0)	0 (0)	0 (0)	0 (0)
		CPVC	150 (1.03)	140 (.97)	130 (.90)	120 (.83)	110 (.75)	100 (.70)	90 (.62)	80 (.55)	70 (.48)	60 (.41)	50 (.34)	0 (0)



# THREADED JOINTS AND THREADING OF PVC AND CPVC PIPE

Charlotte Pipe generally recommends socket (solvent cement) jointing for thermoplastic piping systems. Threaded systems may be used for smaller-size, low-pressure plastic systems, if desired. Transitions to metal or other dissimilar materials may be completed using molded male or female threaded adapters or cut threads on Schedule 80 pipe or flanges.

Only Schedule 80 PVC or CPVC pipe can be threaded. Schedule 40 or SDR pipe cannot be threaded; molded threaded adapters must be used on those systems. The pressure rating of molded or cut threads must be derated by 50%.

See pressure/temperature derating information in this technical manual for systems exposed to operating conditions above 73°F.

Insert a tapered plug into the end of the pipe to be threaded. This plug will provide additional support and prevent distortion of the pipe in the threading area.

It is recommended that a cutting lubricant, such as a soap and water solution or a water soluble machine oil, be used during the threading operation. Also, clearing the cuttings from the die is highly recommended.

Do not over-thread the pipe. Consult the diagram and table showing ASTM F 1498 dimensions for American Standard Taper pipe threads. Periodically check the threads with a ring gauge to ensure that the threads are accurate. The tolerance is  $\pm 1\frac{1}{2}$  turns.

## Procedure for Cutting Threads in Schedule 80 Pipe:

### 1. Cutting

The pipe must be cut square using a power saw, a miter box, or a plastic pipe cutter. Burrs should be removed using a knife or deburring tool.

### 2. Threading

Threads can be cut using either hand held or power threading equipment. The cutting dies should be clean, sharp, and in good condition. Special dies for cutting plastic pipe are available and are recommended.

When using a hand threader, the dies should have a 5° to 10° negative front rake. When using a power threader, the dies should have a 5° negative front rake and the die heads should be self-opening. A slight chamfer to lead the dies will speed production. However, the dies should not be driven at high speeds or with heavy pressure.

When using a hand held threader, the pipe should be held in a pipe vise. To prevent crushing or scoring of the pipe, a protective wrap such as emery paper, canvas, rubber, or a light metal sleeve should be used.

## Installation of Threaded Connections:

Make sure the threads are clean. Charlotte Pipe generally recommends Teflon\* tape as a sealant for threaded connections. Use a good quality Teflon tape which has .4 minimum density, .003" thick, .50% elongation and chemically inert. Wrap the Teflon tape around the entire length of the threads; start with two wraps at the end and wrap all threads overlapping half the width of the tape. Wrap in the direction of the threads on each wind.

Charlotte does **not** recommend pipe joint compounds, pastes or lubricants for thermoplastic pipe as the use of an incompatible compound may result in the degradation or failure of the plastic pipe or fittings. If using one of these compounds as a thread sealant, always verify with the manufacturer of those compounds the suitability for use with ABS, PVC or CPVC. Charlotte Pipe **cannot** be responsible for any failures associated with the use of incompatible thread sealants or joint compounds.

Make threaded connections and hand tighten. Further tighten approximately one turn past hand tight using a **strap wrench only**. Do not use common wrenches or tools designed for metallic pipe systems. Avoid over-tightening as this will cause distortion or damage to threads or fittings.

\*Trademark of the E.I. DuPont Company



# THREADED JOINTS AND THREADING OF PVC AND CPVC PIPE

## Notes on Threaded Connections:

- Make threaded connections on FlowGuard Gold® CPVC systems using Charlotte® brass transition fittings. See the Charlotte FlowGuard Gold® Technical Manual for more information. These fittings are available in male, female and drop-ear ell configurations.
- When connecting to metallic piping components the preferred connection method is to use plastic male threads screwed into female metallic pipe threads. Metallic male pipe threads exert high stress levels on female plastic pipe threaded fittings and should be avoided wherever possible.
- Only join to threaded components conforming to ANSI/ASME B 1.20.1 or ASTM F 1498.
- Brass threaded transition fittings are recommended for all hot water applications.
- Teflon tape is recommended for all threaded connections and should be a .4 minimum density, .003" thick, .50% elongation and chemically inert. To apply start with two wraps at fitting end, wrap all threads overlapping half the width of the tape in the direction of the threads on each wind.

**Use of improper paste type pipe sealant may result in failure of pipe or fittings. Always verify with the manu-**

**facturer of the pipe sealant to confirm chemical compatibility with CPVC and brass components. Never use joint compound containing ammonia or chlorine on brass threaded fittings.**

**Note:**

- **Never use pneumatic tools for tightening.**
- **Never apply more than light pressure on male brass or CPVC threaded fitting when clamping in a vise.**
- **Never clamp female brass transition fittings in a vise.**

The following chart shows the correct amount of tape and torque required to make a properly functioning assembly.

Installation of Brass and CPVC Threaded Fittings			
Pipe Size	Torque Setting		Teflon Tape
	Brass Threaded Fittings	CPVC Threaded Fittings	
1/2"	14 ft.lbs.	3 to 5 ft.lbs.	1/2" width
3/4"	18 ft.lbs.	4 to 6 ft.lbs.	1/2" width
1"	24 ft.lbs.	5 to 7 ft.lbs.	1/2" width
1 1/4"	30 to 60 ft.lbs.	5 to 7 ft.lbs.	1" width
1 1/2"	23 to 34 ft.lbs.	6 to 8 ft.lbs.	1" width
2"	36 to 50 ft.lbs.	8 to 10 ft.lbs.	1" width

Note: 1 foot pound = 12 inch pounds

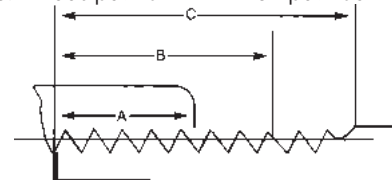

## External Taper Thread Dimensions Diagram

\*Per ANSI/AME B1.20.1 and ASTM F 1498

PIPE		* EXTERNAL THREAD			
Nominal Size In Inches	Outside Diameter In Inches (D)	Number of Threads Per Inch	Normal Engagement By Hand In Inches (A)	Length of Effective Thread In Inches (B)	Total Length: End of Pipe to Vanish Point In Inches (C)
1/4	.540	18	.228	.4018	.5946
3/8	.675	18	.240	.4078	.6006
1/2	.840	14	.320	.5337	.7815
3/4	1.050	14	.339	.5457	.7935
1	1.315	11 1/2	.400	.6828	.9845
1 1/4	1.660	11 1/2	.420	.7068	1.0085
1 1/2	1.900	11 1/2	.420	.7235	1.0252
2	2.375	11 1/2	.436	.7565	1.0582
2 1/2	2.875	8	.682	1.1375	1.5712
3	3.500	8	.766	1.2000	1.6337
4	4.500	8	.844	1.3000	1.7337
6	6.625	8	.958	1.5125	1.9462
8	8.625	8	1.063	1.7125	2.1462

# JOINING ROLL-GROOVED PIPE and ANTIFREEZE SOLUTIONS

## Joining Roll-Grooved Pipe

Roll-grooved PVC pipe is designed for use with conventional gasketed mechanical couplings. It offers a method of joining which is quick and convenient, and it can be used in applications where frequent assembly and disassembly are desirable.

### Installation

1. Consult with the manufacturer of the couplings for recommendations on the coupling style(s) designed for use with PVC pipe and the gasket material which is suitable for the intended service.



2. Check the pipe ends for any damage, roll marks, projections, or indentations on the outside surface between the groove and the end of the pipe. This is the sealing area, and it must be free of any defects.
3. Disassemble the coupling and remove the gasket. Inspect for any damage and make sure the gasket material is suitable for the intended service. Apply a thin coat of silicone lubricant to the gasket tips and the outside of the gasket.
4. Slide the gasket onto the end of one length of pipe so that it is flush with the end. Align and bring the end of another length of pipe together while sliding the gasket back over this junction. The gasket should be centered between the grooves and should not extend into the groove on either length of pipe.
5. Place the coupling housings over the gasket. The housing keys should engage into the grooves. Insert the bolts and apply the nuts. Tighten to "finger tight."

6. Using a wrench, alternately tighten the nuts to the coupling manufacturer's specifications. Over tightening is not necessary, and uneven tightening may cause gasket pinching.



## Antifreeze Solutions - Pressure Testing CPVC and PVC Piping at Reduced Temperature

**Glycerin antifreeze solutions are recommended for use with FlowGuard Gold® and Corzan® water distribution systems and for PVC pressure and DWV applications.**

Glycerin antifreeze should be diluted to the appropriate concentration that provides adequate protection for the intended application. Maximum freeze protection for glycerin-water solutions is -51.7°F (-46.5°C) and occurs when the weight percent of glycerin is 66.7%. The effectiveness of a glycerin/water antifreeze solution diminishes above this concentration. Freeze points of glycerin-water solutions follow:

### Freezing Points of Glycerin-Water Solutions (weight %)

Glycerin by weight (%)	Freeze Point °F (°C)
0	32.0 (0.0)
10	29.1 (-1.6)
20	23.4 (-4.8)
30	14.9 (-9.5)
40	4.3 (-15.4)
50	-9.4 (-23.0)
60	-30.5 (-34.7)
66.7	-51.7 (-46.5)
Greater than 66.7	Not Recommended

**Propylene glycol or ethylene glycol antifreeze solutions are suitable for use in pressure testing PVC pressure and DWV piping systems as follows:**

- Solutions greater than 50% propylene glycol are incompatible with PVC and may cause damage to PVC piping systems.
- Ethylene glycol is compatible with PVC piping systems up to 100% concentrations.
- 25% Propylene glycol solutions are approved for use with potable water systems and provide freeze protection to about 15°F (-10°C), 50% solutions provide freeze protection to -30°F (-34°C).
- **Ethylene glycol solutions are toxic and must therefore be avoided in potable water and food processing systems. 25% ethylene glycol solutions provide freeze protection to about 8°F (-13°C) and 50% solutions provide freeze protection to about -33°F (-36°C).**

Once the roughing-in is completed on a plastic drain, waste, and vent piping system, it is important to test and inspect all piping for leaks. Concealed work should remain uncovered until the required test is made and approved. When testing, the system should be properly restrained at all bends, changes of direction, and the end of runs.

There are various types of procedures used for testing installed plastic systems. **CAUTION: In any test, proper safety procedures and protective eyewear, clothing, and equipment should be used. Installers should always consider local conditions, codes and regulations, manufacturer's installation instructions, and architects'/engineers' specifications in any installation.**

## Testing DWV System

### Water Test

A water or hydrostatic test is the most technically superior test used to inspect a completed plastic piping system installation and is the testing procedure recommended by **Charlotte Pipe**. It is also the most recommended test in most plumbing code standards. The purpose of the test is to locate any leaks at the joints and correct them prior to putting the system into operation. Since it is important to be able to visually inspect the joints, a water test should be conducted prior to closing in the piping or backfilling of underground piping.

To isolate each floor or section being tested, test plugs are inserted through test tees in the stack. All other openings should be plugged or capped with test plugs or test caps. **When testing Foam Core pipe, always use external caps to eliminate the possibility of leakage through the foam core part of the pipe.** Fill the system to be tested with water at the highest point. As water fills a vertical pipe it creates hydrostatic pressure. The pressure increases as the height of the water in the vertical pipe increases. **Charlotte Pipe recommends testing at 10 feet of hydrostatic pressure (4.3 pounds per square inch.)** Filling the system slowly should allow any air in the system to escape as the water rises in the vertical pipe. **All entrapped air in the system should be expelled prior to the beginning of the test. Failure to remove entrapped air may give faulty test results.**

Once the stack is filled to "ten feet of head," a visual inspection of the section being tested should be made to check for leaks. If a leak is found, the joint must be cut out and a new section installed. Fifteen minutes is a suitable time for the water test. Once the system has been successfully tested, it should be drained and the next section prepared for testing.

## DO NOT USE CHARLOTTE PIPE PRODUCTS FOR COMPRESSED AIR OR GASES

Charlotte Pipe and Foundry Company products are not intended to be used for distribution or storage of compressed air or gases. Use of Charlotte Pipe products in inappropriate applications could result in product failure, serious injury or death.

### Air or Gas Testing - Not Recommended

Air or compressed gas test are sometimes performed instead of hydrostatic (water) test. DANGER: Charlotte Pipe and Foundry Company **does not** recommend air or gas testing, consistent with PPFA User Bulletin 4-80 and / or ASTM D 1785. **Pipe and fitting materials under air or gas pressure can explode, causing serious injury or death.** Charlotte Pipe will not be responsible or liable for injury or death to persons or damage to property or for claims for labor and / or material arising from any alleged failure of our products during testing with air or compressed gasses.

## Hydronic Heating Applications

The table below highlights key points to remember when installing FlowGuard Gold or Corzan CPVC in a hydronic radiant heating application. A hydronic radiant heating application is defined here as piping directly off a hot water heater or boiler into a coil heating unit in single- or multi-family homes.

### **“DOs” for all hydronic applications**

- Install in accordance with both Charlotte Pipe and Foundry’s and solvent cement manufacturer’s recommendations and installation instructions.
- Follow recommended safe work practices.
- Verify that the maximum outlet temperature and pressure of the boiler is less than the temperature and pressure rating of the pipe (see charts below).
- Always use the proper derating factors with FlowGuard Gold and Corzan pipe to find the pressure rating at the applicable operating temperature.
- Always follow local codes and approvals when installing plumbing and heating equipment.
- Ensure that the system design allows for thermal expansion and contraction as recommended in the Charlotte Pipe and Foundry Plastics Technical Manual.
- Use only CPVC x brass transition fittings if using threaded connections.
- Use proper solvent cementing practices, including beveling and proper dauber sizing.
- Provide additional support to the brass side of a CPVC x brass transition or other metallic components to support the weight of the metal system.
- Use check valves, heat traps or back flow preventer to prevent cross-connections between hot and cold water lines.
- Flush the interior of heat exchangers or the exterior of condenser coils thoroughly with mild ionic detergent solution to remove incompatible oils prior to piping installation.
- Rinse with clean water to purge the system as a final flushing.
- Verify that all boiler cleaning and sealing chemicals used in the hydronic radiant heating system are compatible with CPVC.

### **“DON’Ts” for all hydronic applications**

- Do not exceed the operating temperature or operating pressure of the piping system.
- Do not use 100% CPVC threaded adapters, male or female.
- Do not use the CPVC piping system to support any metallic components.
- Do not use compression fittings for hydronic radiant heating applications.
- Do not use solvent cement that exceeds its shelf life, has become discolored or has gelled.
- Do not use CPVC tees or other CPVC components as mixing devices.
- Do not over solvent-cement the joints. Puddling of solvent cement must be avoided.
- Do not rely on an expansion tank to handle thermal expansion of the piping system. Expansion tanks accommodate expansion of the fluid, not longitudinal expansion of the pipe. The piping system must be designed to allow for thermal expansion.

**FlowGuard Gold Pressure Rating Chart (psi)**

Pipe Size	73°F	80°F	120°F	140°F	180°F
ALL (SDR-11)	400	328	260	200	100

**Corzan Schedule 80 Pressure Rating Chart (psi)**

Pipe Size	73°F	80°F	120°F	140°F	180°F
2"	400	328	260	200	100
3"	370	303	241	185	93
4"	320	262	208	160	80
6"	280	230	182	140	70
8"	250	205	163	125	63

## Selection of Materials For Sanitary and Storm Drainage

Engineers and designers today have a number of materials from which to choose as they design sanitary and storm drainage systems for residential and commercial projects. Due to its exceptional strength and combination of being non-combustible and extremely quiet, cast iron soil pipe is a very popular choice for commercial construction. Upscale homes often feature cast iron stacks combined with plastic used for lavs, showers and tubs for a system Charlotte Pipe calls a "Quiet House®" design. PVC and ABS DWV systems are allowed under all of the major national plumbing codes unless restricted by local or state amendment and are very popular as well.

Charlotte Pipe manufacturers ABS cellular (foam) core pipe conforming to ASTM F 628 as well as PVC pipe in both solid wall and cellular core types. PVC solid wall meets the requirements of ASTM D 1785 and D 2665, and PVC cellular core pipe conforms to ASTM F 891. All of these plastic pipe systems are allowed for sanitary and storm drainage both above and below grade in the Uniform Plumbing Code (UPC), the International Plumbing Code (IPC), the National Standard Plumbing Code (NSPC) and most local or state variations thereof. None of these national model codes differentiate between residential or commercial uses of these plastic systems or otherwise restrict the use of any of these systems to any specific class of construction. All of the systems can be installed below grade, under slab and above grade in most areas except those classified as "return air plenums."

Solid wall pipe is just as the name implies: solid PVC material throughout the entire pipe wall. Cellular core pipe is manufactured using a unique co-extrusion process that produces pipe with a thin solid inner layer and outer layer with a foam core between these walls. Foam core pipe has the exact same dimensions as solid wall, yet is lighter and less expensive. Noise transmission is a function of density so while cast iron is by far the quietest material, PVC solid wall would be somewhat less noisy than either PVC or ABS cellular core pipe. While both are suitable for burial at most depths and common soil types, solid wall pipe is somewhat more "robust" and has a higher pipe stiffness, particularly in sizes 6" and smaller. Both ASTM F 628 and F 891 have the following limitation; Appendix X3, Installation, paragraph X3.1: minimum aggregate size shall be limited to 1/2 in. (13 mm) for angular and 3/4 in. (19 mm) for rounded particles. This statement is significant as ASTM D 2321 allows aggregate and stone that pass through 1-1/2" sieve. PVC is classified as a flexible piping system, and as such it is dependant upon proper bedding and backfill for its ability to withstand Earth and live loads. Therefore, all plastic pipe must be installed below grade in accordance with ASTM D 2321. Cellular core pipe of any type is designed for drainage only, carries no pressure rating and Charlotte Pipe marks each piece with the print line

"Not for Pressure." PVC solid wall pipe is "dual marked" and meets the ASTM standards for both pressure and drainage pipe.

Many designers allow the use of cellular core pipe on residential or light commercial projects and require the use of solid wall PVC or cast iron on commercial projects such as institutions, schools, restaurants, hospitals etc. Charlotte Pipe recommends that cellular core PVC pipe be installed in commercial applications with caution. Underground installations should be in strict conformance to ASTM D 2321. Ultimately the engineer, designer, developer or owner must evaluate the requirements of each project and specify the products they feel best suit their design criteria.

## Engineered Applications

Over the past years many new innovations have been introduced to the industry including siphonic roof drainage, solvent, air admittance devices and other products. Some of these products do not conform to existing standards or to the requirements of the model plumbing codes. Rather they are designed into the system by engineers and approved as an alternate material within the code.

Charlotte Pipe and Foundry manufactures pipe and fitting systems that conform to published ASTM and Cast Iron Soil Pipe Institute standards. Products are warranted to conform to the requirements of applicable standards when used for the applications defined within these standards. Charlotte Pipe and Foundry will not accept liability for applications that do not conform to the standards to which we manufacture.

## Unstable Soil

Burial of pipe under slab in soils that are unstable is often accomplished by suspending the piping systems from structural slabs. The use of plastic pipe in such installations must be in accordance with ASTM F 2536. Cellular core pipe is specifically not permitted for these applications.

## Using Plastics for Combustion Gas Venting

Charlotte Pipe recommends that inquiries about the suitability of plastic piping systems for venting combustion gasses should be made to the manufacturer of the water or space heating equipment being installed. As stated in the International Code Council's International Fuel Gas Code 503.4.1.1:

Plastic Pipe and fittings used to vent appliances shall be installed in accordance with the appliance manufacturer's installation instructions.

Furthermore, several of the ASTM standards applicable to plastic pipe and fittings that Charlotte Pipe manufactures include the following note: **This standard specification does not include requirements for pipe and fittings intended to be used to vent combustion gases.**

# CHEMICAL RESISTANCE

The following table gives the chemical resistance of ABS, PVC and CPVC thermoplastic piping materials and three commonly used seal materials. The information shown is based upon laboratory tests conducted by the manufacturers of the materials, and it is intended to provide a general guideline on the resistance of these materials to various chemicals. **It is not a guarantee, and any piping systems using products made of these materials should be tested under actual service conditions to determine their suitability for a particular purpose.** See website for most current data: [www.charlottepipe.com](http://www.charlottepipe.com)

Number = Maximum Recommended Temp. (°F)\*\* CF = Consult Factory NR = Not Recommended •• = Incomplete Data

Chemical Name	Pipe & Fitting Materials Recommended Max. Temp (°F)			Seal Materials Recommended Max. Temp. (°F)		
	ABS	PVC	CPVC	Viton®	EPDM	Neoprene
Acetaldehyde .....	NR	NR	NR	NR	200	NR
Acetamide .....	120	••	••	NR	200	NR
Acetate Solvent, Crude .....	NR	NR	NR	••	••	••
Acetate Solvent, Pure .....	NR	NR	NR	••	••	••
Acetic Acid, 10% .....	120	140	180	NR	180	NR
Acetic Acid, 20% .....	NR	140	NR	NR	180	NR
Acetic Acid, 50% .....	NR	73	NR	NR	140	NR
Acetic Acid, 80% .....	NR	73	NR	NR	100	NR
Acetic Acid, Glacial .....	NR	NR	NR	NR	100	NR
Acetic Anhydride .....	NR	NR	NR	NR	NR	70
Acetone .....	NR	NR	NR	NR	130	NR
Acetonitrile .....	NR	NR	NR	NR	NR	70
Acetophenone .....	NR	NR	NR	NR	140	NR
Acetyl Chloride .....	NR	NR	NR	185	NR	NR
Acetylene .....	160§	140§	180§	200	200	70
Acetyl Nitrile .....	NR	NR	NR	NR	NR	NR
Acrylic Acid .....	NR	NR	NR	••	••	••
Acrylonitrile .....	NR	NR	NR	NR	NR	NR
Adipic Acid (Sat'd) .....	••	140	180	200	200	200
Allyl Alcohol .....	NR	NR	NR	100	70	70
Allyl Chloride .....	NR	NR	NR	70	NR	••
Alums .....	160	140	180	NR	200	160
Aluminum Acetate .....	160	••	180	NR	200	NR
Aluminum Ammonium .....	••	140	180	200	200	160
Aluminum Chloride .....	160	140	180	200	200	160
Aluminum Chrome .....	••	140	180	200	200	160
Aluminum Fluoride .....	NR	73	180	200	200	160
Aluminum Hydroxide .....	160	140	180	200	200	100
Aluminum Nitrate .....	160	140	180	100	200	100
Aluminum Oxychloride .....	160	140	180	NR	••	••
Aluminum Potassium Sulfate .....	160	140	180	200	200	160
Aluminum Sulfate .....	160	140	180	185	200	140
Amines .....	NR	••	NR	••	••	••
Ammonia .....	73	140	NR	NR	175	150
Ammonia, Gas .....	160§	140§	NR	NR	140	140
Ammonia, Aqua, 10% .....	••	73	NR	NR	140	••
Ammonia, (25% Aqueous Solution) .....	160	NR	NR	NR	140	••
Ammonia Hydroxide .....	73	100	NR	NR	175	150
Ammonia Liquid (Concentrated) .....	NR	NR	NR	NR	140	70
Ammonium Acetate .....	••	140	180	73	140	140

Acrylonitrile-Butadiene-Styrene Polyvinyl Chloride Type 1 Grade 1 Chlorinated Polyvinyl Chloride Type IV Grade 1 Fluorocarbon Elastomer (Viton® is a registered trademark of the DuPont Co.) Ethylene Propylene Diene Monomer

\*\* Maximum recommended temperature, for chemical resistance, under normal conditions. § Non-pressure, vent-only, applications when chemical is in gas form.

# CHEMICAL RESISTANCE

Number = Maximum Recommended Temp. (°F)\*\* CF = Consult Factory NR = Not Recommended •• = Incomplete Data

Chemical Name	Pipe & Fitting Materials Recommended Max. Temp (°F)			Seal Materials Recommended Max. Temp. (°F)		
	ABS	PVC	CPVC	Viton®	EPDM	Neoprene
Ammonium Benzoate .....	••	••	180	••	••	••
Ammonium Bifluoride .....	••	140	180	200	200	••
Ammonium Bisulfide .....	160	140	180	••	••	••
Ammonium Carbonate .....	160	140	180	200	200	140
Ammonium Chloride .....	120	140	180	200	200	160
Ammonium Citrate .....	120	••	180	••	••	••
Ammonium Dichromate .....	120	73	••	••	70	100
Ammonium Fluoride, 10% .....	120	140	180	••	200	100
Ammonium Fluoride, 25% .....	120	73	180	••	140	••
Ammonium Hydroxide .....	120	73	NR	70	200	150
Ammonium Metaphosphate .....	120	140	180	200	200	••
Ammonium Nitrate .....	120	140	180	100	200	160
Ammonium Persulphate .....	120	140	73	••	200	70
Ammonium Phosphate .....	120	140	73	185	200	140
Ammonium Sulfamate .....	120	••	180	••	••	••
Ammonium Sulfate .....	120	140	180	200	200	160
Ammonium Sulfide .....	120	73	180	200	200	••
Ammonium Thiocyanate .....	120	140	180	185	••	70
Ammonium Tartrate .....	120	140	180	••	••	••
Amyl Acetate .....	NR	NR	NR	NR	70	NR
Alcohol, Amyl .....	NR	NR	NR	185	200	140
Amyl Chloride .....	NR	NR	NR	200	NR	NR
Aniline .....	NR	NR	NR	NR	140	NR
Aniline Chlorohydrate .....	NR	NR	••	••	••	••
Aniline Hydrochloride .....	NR	NR	NR	185	••	NR
Anthraquinone Sulfonic Acid .....	••	140	••	200	••	••
Antimony Trichloride .....	••	140	180	185	140	140
Aqua Regia .....	NR	NR	73	100	NR	NR
Aromatic Hydrocarbons .....	NR	NR	NR	73	NR	NR
Argon .....	••	••	••	200	200	100
Arsenic Acid .....	••	140	73	200	185	NR
Aryl Sulfonic Acid .....	••	140	••	185	140	••
Asphalt .....	NR	NR	NR	180	NR	NR
Barium Carbonate .....	120	140	180	200	200	160
Barium Chloride .....	120	140	180	200	200	160
Barium Hydroxide .....	120	140	180	200	180	150
Barium Nitrate .....	120	73	180	200	200	160
Barium Sulfate .....	120	140	180	200	200	160
Barium Sulfide .....	120	140	180	200	140	160
Beer .....	120	140	180	200	200	140
Beet Sugar Liquids .....	120	140	180	185	200	160
Benzaldehyde .....	NR	NR	NR	NR	140	NR
Benzalkonium Chloride .....	NR	NR	NR	••	••	••
Benzene .....	NR	NR	NR	150	NR	NR
Benzene, Benzol .....	NR	NR	NR	200	200	••

Acrylonitrile-Butadiene-Styrene Polyvinyl Chloride Type 1 Grade 1 Chlorinated Polyvinyl Chloride Type IV Grade 1 Fluorocarbon Elastomer (Viton® is a registered trademark of the DuPont Co.) Ethylene Propylene Diene Monomer

\*\* Maximum recommended temperature, for chemical resistance, under normal conditions. § Non-pressure, vent-only, applications when chemical is in gas form.



# CHEMICAL RESISTANCE

Number = Maximum Recommended Temp. (°F)\*\* CF = Consult Factory NR = Not Recommended •• = Incomplete Data

Chemical Name	Pipe & Fitting Materials Recommended Max. Temp (°F)			Seal Materials Recommended Max. Temp. (°F)		
	ABS	PVC	CPVC	Viton ®	EPDM	Neoprene
Benzene Sulfonic Acid .....	NR	NR	NR	185	NR	100
Benzoic Acid, (Sat'd) .....	160	140	73	••	NR	160
Benzyl Chloride .....	NR	••	NR	••	••	••
Benzyl Alcohol .....	NR	NR	NR	140	NR	NR
Bismuth Carbonate .....	160	140	180	••	••	70
Black Liquor .....	73	140	180	200	180	70
Bleach, Industrial (15% Cl <sub>2</sub> ) .....	73	140	180	185	70	••
Bleach, 12.5% Active Cl <sub>2</sub> .....	73	140	180	R	140	••
Bleach, 5.5% Active Cl <sub>2</sub> .....	73	140	180	R	140	••
Borax .....	160	140	180	185	140	140
Boric Acid .....	160	140	180	185	140	140
Breeders Pellets, Deriv. Fish .....	160	140	180	••	••	••
Brine, Acid .....	73	73	180	200	200	160
Bromic Acid .....	73	140	180	70	70	••
Bromine .....	NR	NR	NR	70	NR	NR
Bromine, Liquid .....	NR	NR	NR	70	NR	NR
Bromine, Vapor 25% .....	NR	140	••	••	NR	••
Bromine, Water .....	NR	73	73	185	NR	NR
Bromine, Water, (Sat'd) .....	NR	73	73	••	••	••
Bromobenzene .....	NR	NR	NR	150	NR	NR
Bromotoluene .....	NR	NR	NR	NR	NR	NR
Butadiene .....	NR	140	73	185	NR	140
Butane .....	NR	140	••	185	NR	70
Butanol, Primary .....	NR	NR	NR	••	••	••
Butanol, Secondary .....	NR	NR	NR	••	••	••
Butyl Acetate .....	NR	NR	NR	NR	140	NR
Butyl Alcohol .....	73	100	NR	75	200	140
Butyl Carbitol .....	••	••	NR	••	••	••
Butyl Cellosolve (2-butoxyethanol) .....	NR	73	NR	NR	140	••
Butynediol .....	NR	73	••	••	••	••
Butylene .....	NR	73	••	100	NR	NR
Butyl Phenol .....	NR	73	••	••	••	NR
Butyl Pthalate .....	NR	NR	NR	70	••	••
Butyl Stearate .....	NR	73	73	200	NR	NR
Butyric Acid .....	NR	NR	NR	70	140	NR
Butyric Acid, Up to 1% .....	73	73	180	73	140	••
Butyric Acid, Over 1% .....	NR	••	NR	••	••	••
Cadmium Acetate .....	••	••	180	••	••	••
Cadmium Chloride .....	••	••	180	••	••	••
Cadmium Cyanide .....	••	140	180	••	••	70
Cadmium Sulfate .....	••	••	180	••	••	••
Caffeine Citrate .....	••	73	••	••	••	••
Calcium Acetate .....	NR	73	180	••	R	••
Calcium Bisulfide .....	NR	NR	180	185	••	••
Calcium Bisulfite .....	NR	140	180	185	NR	70

Acrylonitrile-Butadiene-Styrene Polyvinyl Chloride Type 1 Grade 1 Chlorinated Polyvinyl Chloride Type IV Grade 1 Fluorocarbon Elastomer (Viton ® is a registered trademark of the DuPont Co.) Ethylene Propylene Diene Monomer

\*\* Maximum recommended temperature, for chemical resistance, under normal conditions. § Non-pressure, vent-only, applications when chemical is in gas form.

# CHEMICAL RESISTANCE

Number = Maximum Recommended Temp. (°F)\*\* CF = Consult Factory NR = Not Recommended •• = Incomplete Data

Chemical Name	Pipe & Fitting Materials Recommended Max. Temp (°F)			Seal Materials Recommended Max. Temp. (°F)		
	ABS	PVC	CPVC	Viton®	EPDM	Neoprene
Calcium Carbonate .....	160	140	180	200	200	70
Calcium Chlorate .....	160	140	180	185	140	70
Calcium Chloride.....	160	140	180	200	200	160
Calcium Hydroxide.....	160	140	180	200	200	70
Calcium Hypochlorite .....	160	140	180	185	70	••
Calcium Nitrate .....	160	140	180	200	200	100
Calcium Oxide .....	160	140	180	••	200	160
Calcium Sulfate .....	160	140	180	200	200	160
Camphor Crystals.....	NR	73	••	200	200	NR
Cane Sugar Liquors.....	120	140	180	200	200	160
Caprolactam .....	NR	••	NR	••	••	••
Caprolactone .....	NR	••	NR	••	••	••
Caprylic Acid .....	NR	••	NR	••	••	••
Carbitol™ .....	NR	NR	NR	70	140	70
Carbon Bisulfide .....	NR	NR	NR	••	••	••
Carbon Dioxide, Wet .....	160	140	180	200	200	160
Carbon Dioxide, Dry.....	160	140	180	200	200	160
Carbon Disulfide .....	NR	NR	NR	200	NR	NR
Carbonic Acid .....	••	140	180	200	200	70
Carbon Monoxide.....	160	140	180	200	200	70
Carbon Tetrachloride .....	NR	NR	NR	185	NR	NR
Castor Oil .....	NR	140	NR	••	140	100
Caustic Potash .....	160	140	CF	NR	140	160
Caustic Soda .....	160	140	CF	NR	70	100
Cellosolve .....	NR	73	NR	NR	140	••
Cellosolve Acetate .....	NR	••	NR	NR	140	NR
Chloracetic Acid.....	73	73	180	NR	73	••
Chloracetyl Chloride.....	NR	73	••	••	••	••
Chloral Hydrate .....	••	140	180	NR	••	70
Chloramine .....	NR	73	••	••	••	70
Chloric Acid, 20% .....	••	140	180	140	••	140
Chlorinated Solvents .....	NR	NR	NR	••	••	••
Chlorinated Water, Up to 3500 ppm .....	160	140	CF	185	100	NR
Chlorinated Water, Above 3500 ppm.....	NR	NR	NR	185	NR	NR
Chlorine Gas, Dry .....	NR	NR	NR	185	NR	NR
Chlorine Gas, Wet .....	NR	NR	NR	185	NR	NR
Chlorine, Liquid .....	NR	NR	NR	100	NR	••
Chlorine, trace in air .....	••	••	180§	••	••	••
Chlorine Dioxide (sat'd aqueous sol.) .....	••	••	180	••	••	••
Chlorine Water, (Sat'd) .....	••	140	180	200	73	••
Chlorobenzene .....	NR	NR	NR	70	NR	NR
Chlorobenzene Chloride .....	NR	NR	NR	200	••	••
Chloroform .....	NR	NR	NR	70	NR	NR
Chloropicrin .....	NR	NR	NR	••	••	••
Chlorosulfonic Acid .....	••	73	73	NR	NR	NR

Acrylonitrile-Butadiene-Styrene Polyvinyl Chloride Type 1 Grade 1 Chlorinated Polyvinyl Chloride Type IV Grade 1

Fluorocarbon Elastomer (Viton® is a registered trademark of the DuPont Co.) Ethylene Propylene Diene Monomer

\*\* Maximum recommended temperature, for chemical resistance, under normal conditions. § Non-pressure, vent-only, applications when chemical is in gas form.

# CHEMICAL RESISTANCE

Number = Maximum Recommended Temp. (°F)\*\* CF = Consult Factory NR = Not Recommended •• = Incomplete Data

Chemical Name	Pipe & Fitting Materials Recommended Max. Temp (°F)			Seal Materials Recommended Max. Temp. (°F)		
	ABS	PVC	CPVC	Viton ®	EPDM	Neoprene
Chlorox Bleach Solution, 5.5% Cl <sub>2</sub> .....	73	140	180	200	140	••
Chromic Acid, 10% .....	73	140	180	140	70	NR
Chromic Acid, 30% .....	NR	73	180	140	NR	NR
Chromic Acid, 40% .....	NR	73	180	140	NR	NR
Chromic Acid, 50% .....	NR	75	140	140	NR	NR
Chromium Nitrate .....	••	••	180	••	••	••
Chromium Potassium Nitrate .....	73	73	73	200	140	160
Citric Acid (Sat'd) .....	160	140	180	200	200	140
Citric Acid, 10% .....	160	140	180	••	••	••
Citrus Oils.....	••	••	NR	••	••	••
Coconut Oil .....	NR	140	NR	185	NR	100
Coke Oven Gas .....	NR	NR	NR	185	70	••
Copper Acetate, (Sat'd) .....	73	73	73	140	100	160
Copper Carbonate .....	120	140	180	185	200	••
Copper Chloride .....	73	140	180	200	200	160
Copper Cyanide .....	73	140	180	185	200	160
Copper Fluoride .....	73	140	180	185	200	140
Copper Nitrate .....	120	140	180	200	200	160
Copper Salts .....	160	140	180	••	••	••
Copper Sulfate .....	160	140	180	200	200	160
Corn Oil .....	73	140	NR	200	NR	NR
Corn Syrup .....	120	140	180	185	••	100
Cottonseed Oil .....	120	140	NR	185	NR	••
Creosote .....	NR	NR	NR	73	NR	NR
Cresol .....	NR	NR	NR	100	NR	NR
Cresylic Acid, 50% .....	NR	140	NR	185	NR	NR
Crotonaldehyde .....	NR	NR	NR	NR	NR	70
Crude Oil .....	NR	73	180	200	NR	••
Cumene .....	••	••	••	200	NR	NR
Cupric Fluoride .....	73	140	180	••	200	••
Cupric Sulfate .....	160	140	180	200	200	160
Cuprous Chloride .....	73	140	180	200	200	70
Cyclohexane .....	NR	NR	NR	185	NR	NR
Cyclohexanol .....	NR	NR	NR	185	NR	NR
Cyclohexanone .....	NR	NR	NR	NR	70	NR
Decalin .....	NR	NR	NR	••	••	••
D-Limonene .....	••	••	NR	••	••	••
Desocyphephrine .....	••	73	••	••	••	••
Detergents .....	73	140	NR	200	200	160
Detergent Solution, Heavy Duty .....	73	140	NR	200	200	160
Dextrine .....	••	140	180	200	NR	••
Dextrose .....	120	140	180	200	140	160
Diacetone Alcohol .....	NR	NR	NR	NR	70	NR
Diazo Salts .....	••	140	180	••	••	••
Dibutoxy Ethyl Phthalate .....	NR	NR	NR	200	70	NR

Acrylonitrile-Butadiene-Styrene Polyvinyl Chloride Type 1 Grade 1 Chlorinated Polyvinyl Chloride Type IV Grade 1  
Fluorocarbon Elastomer (Viton ® is a registered trademark of the DuPont Co.) Ethylene Propylene Diene Monomer

\*\* Maximum recommended temperature, for chemical resistance, under normal conditions. § Non-pressure, vent-only, applications when chemical is in gas form.

# CHEMICAL RESISTANCE

Number = Maximum Recommended Temp. (°F)\*\* CF = Consult Factory NR = Not Recommended •• = Incomplete Data

Chemical Name	Pipe & Fitting Materials Recommended Max. Temp (°F)			Seal Materials Recommended Max. Temp. (°F)		
	ABS	PVC	CPVC	Viton®	EPDM	Neoprene
Dibutyl Ethyl Phthalate .....	NR	NR	NR	200	70	NR
Dibutyl Phthalate .....	NR	NR	NR	NR	70	NR
Dibutyl Sebacate .....	NR	NR	NR	NR	70	NR
Dichlorobenzene .....	NR	NR	NR	150	NR	NR
Dichloroethylene .....	NR	NR	NR	185	NR	NR
Diesel Fuels .....	NR	73	NR	185	NR	NR
Diethylamine .....	NR	NR	NR	NR	70	••
Diethyl Cellosolve .....	NR	••	NR	200	NR	100
Diethyl Ether .....	NR	NR	NR	NR	NR	••
Diglycolic Acid .....	NR	140	••	70	70	••
Dill Oil .....	••	••	NR	••	••	••
Dimethylamine .....	NR	140	NR	NR	140	NR
Dimethylformamide .....	NR	NR	NR	NR	NR	NR
Dimethyl Hydrazine .....	NR	NR	NR	NR	••	••
Diethyl Phthalate (DEHP) .....	NR	NR	NR	70	70	NR
Dioxane .....	NR	NR	NR	NR	70	NR
Dioxane, 1.4 .....	NR	NR	NR	NR	73	••
Disodium Phosphate .....	120	140	180	••	200	••
Distilled Water .....	160	140	180	200	200	160
Divinylbenzene .....	NR	NR	NR	200	NR	••
Dry Cleaning Fluid .....	NR	NR	NR	200	NR	NR
Dursban TC .....	NR	••	NR	••	••	••
EDTA, Tetrasodium .....	••	••	180	••	••	••
Epsom Salt .....	120	140	180	••	200	••
Epichlorohydrin .....	NR	NR	NR	••	••	••
Esters .....	NR	NR	NR	••	••	••
Ethanol, Up to 5% .....	NR	140	180	••	••	••
Ethanol, Over 5% .....	NR	140	NR	••	••	••
Ethers .....	NR	NR	NR	NR	••	NR
Ethyl Acetate .....	NR	NR	NR	NR	70	NR
Ethyl Acetoacetate .....	NR	NR	NR	NR	100	••
Ethyl Acrylate .....	NR	NR	NR	NR	70	NR
Ethyl Benzene .....	NR	NR	NR	70	NR	NR
Ethyl Chloride .....	NR	NR	NR	140	70	70
Ethyl Chloroacetate .....	NR	NR	NR	••	••	••
Ethylene Bromide .....	NR	NR	NR	70	NR	NR
Ethylene Chloride .....	NR	NR	NR	70	••	••
Ethylene Chlorohydrin .....	NR	NR	NR	NR	70	70
Ethylene Diamine .....	NR	NR	NR	••	70	100
Ethylene Dichloride .....	NR	NR	NR	120	NR	NR
Ethyl Ether .....	NR	NR	NR	NR	NR	NR
Ethylene Glycol, Up to 50% .....	73	140	180	200	200	160
Ethylene Glycol, Over 50% .....	73	140	NR	200	200	160
Ethylene Oxide .....	NR	NR	NR	NR	NR	NR
Fatty Acids .....	160	140	73	185	NR	140

Acrylonitrile-Butadiene-Styrene Polyvinyl Chloride Type 1 Grade 1 Chlorinated Polyvinyl Chloride Type IV Grade 1  
 Fluorocarbon Elastomer (Viton® is a registered trademark of the DuPont Co.) Ethylene Propylene Diene Monomer  
 \*\* Maximum recommended temperature, for chemical resistance, under normal conditions. § Non-pressure, vent-only, applications when chemical is in gas form.

# CHEMICAL RESISTANCE

Number = Maximum Recommended Temp. (°F)\*\* CF = Consult Factory NR = Not Recommended •• = Incomplete Data

Chemical Name	Pipe & Fitting Materials Recommended Max. Temp (°F)			Seal Materials Recommended Max. Temp. (°F)		
	ABS	PVC	CPVC	Viton ®	EPDM	Neoprene
Ferric Acetate .....	NR	73	180	••	••	••
Ferric Chloride .....	120	140	180	200	200	160
Ferric Hydroxide .....	160	140	180	180	180	100
Ferric Nitrate .....	160	140	180	200	200	160
Ferric Sulfate .....	160	140	180	185	200	140
Ferrous Chloride .....	160	140	180	200	200	••
Ferrous Hydroxide .....	160	73	180	180	180	••
Ferrous Nitrate .....	160	73	140	200	180	160
Ferrous Sulfate .....	160	140	180	200	200	160
Fish Solubles .....	160	140	180	70	NR	••
Fluorine Gas .....	NR	NR	NR	NR	NR	NR
Fluoboric Acid .....	••	140	73	140	140	160
Fluorosilicic Acid, 30% .....	73	140	73	200	140	100
Formaldehyde, 35% .....	NR	140	NR	NR	140	140
Formalin (37% to 50% Formaldehyde)	NR	140	NR	NR	140	140
Formic Acid, Up to 25% .....	••	73	180	NR	200	140
Formic Acid, Anhydrous .....	••	73	NR	NR	••	100
Freon F- 11 .....	••	140§	73§	70	NR	NR
Freon F-12 .....	••	140§	73§	NR	NR	130
Freon F-21 .....	••	NR	NR	NR	NR	NR
Freon F-22 .....	••	NR	NR	NR	NR	130
Freon F-113 .....	••	140§	••	130	NR	130
Freon F-114 .....	••	140§	••	NR	NR	70
Fructose .....	120	140	180	200	175	160
Fruit Juices, Pulp .....	73	140	180	200	••	••
Furfural .....	NR	NR	NR	NR	140	70
Gallic Acid .....	••	140	73	185	70	70
Gas, Manufactured .....	NR	73§	NR	••	••	••
Gas, Natural .....	NR	140§	••	185	NR	140
Gasoline, Leaded .....	NR	NR	NR	100	NR	70
Gasoline, Unleaded .....	NR	NR	NR	100	NR	••
Gasoline, Sour .....	NR	NR	NR	100	NR	••
Gasoline, Refined .....	NR	NR	NR	••	••	••
Gelatin .....	120	140	150	200	200	160
Gin .....	NR	140	NR	••	••	••
Glucose .....	120	140	180	200	200	160
Glycerine .....	120	140	180	200	200	160
Glycerine, Glycerol .....	120	140	180	200	200	••
Glycolic Acid .....	••	140	NR	NR	••	70
Glycol Ethers .....	NR	140	NR	••	••	••
Grape Sugar, Juice .....	73	140	180	185	200	160
Green Liquor .....	160	140	180	••	150	70
Halocarbons Oils .....	NR	••	NR	••	••	••
Heptane .....	73	140	NR	185	NR	70
Hexane .....	NR	73	73	70	NR	70

Acrylonitrile-Butadiene-Styrene Polyvinyl Chloride Type 1 Grade 1 Chlorinated Polyvinyl Chloride Type IV Grade 1 Fluorocarbon Elastomer (Viton ® is a registered trademark of the DuPont Co.) Ethylene Propylene Diene Monomer

\*\* Maximum recommended temperature, for chemical resistance, under normal conditions. § Non-pressure, vent-only, applications when chemical is in gas form.

# CHEMICAL RESISTANCE

Number = Maximum Recommended Temp. (°F)\*\* CF = Consult Factory NR = Not Recommended •• = Incomplete Data

Chemical Name	Pipe & Fitting Materials Recommended Max. Temp (°F)			Seal Materials Recommended Max. Temp. (°F)		
	ABS	PVC	CPVC	Viton®	EPDM	Neoprene
Hexanol .....	NR	100	NR	160	NR	70
Hydraulic Oil .....	NR	73	••	200	NR	70
Hydrazine .....	NR	NR	NR	NR	70	••
Hydrobromic Acid, Dilute .....	73	140	180	R	140	••
Hydrobromic Acid, 20% .....	73	140	73	185	140	70
Hydrobromic Acid, 50% .....	NR	140	73	185	140	70
Hydrochloric Acid, Dilute .....	73	140	180	NR	150	••
Hydrochloric Acid, 18% .....	NR	140	180	NR	150	••
Hydrochloric Acid, 20% .....	NR	140	180	NR	150	••
Hydrochloric Acid Conc., 37% .....	NR	140	180	NR	150	••
Hydrocyanic Acid, 10% .....	160	140	••	185	200	••
Hydrofluoric Acid, Dilute .....	NR	73	73	150	NR	70
Hydrofluoric Acid, Up to 3% .....	73	73	73	150	NR	70
Hydrofluoric Acid, 30% .....	NR	73	NR	150	NR	70
Hydrofluoric Acid, 40% .....	NR	73	NR	100	NR	NR
Hydrofluoric Acid, 50% .....	NR	73	NR	75	NR	NR
Hydrofluoric Acid, 100% .....	NR	NR	NR	NR	NR	NR
Hydrofluosilicic Acid, 50% .....	NR	140	140	200	140	••
Hydrogen .....	140§	140§	73§	200	200	160
Hydrogen Cyanide .....	••	140	••	••	••	70
Hydrogen Fluoride .....	NR	NR	NR	NR	70	NR
Hydrogen Peroxide, Dilute .....	73	140	73	200	140	NR
Hydrogen Peroxide, 30% .....	NR	140	73	200	140	NR
Hydrogen Peroxide, 50% .....	NR	140	73	185	100	NR
Hydrogen Peroxide, 90% .....	NR	NR	NR	100	NR	NR
Hydrogen Phosphide .....	••	140	••	••	73	••
Hydrogen Sulfide, Dry .....	••	140	180	140	100	NR
Hydrogen Sulfide, Aqueous Sol. ....	••	140	180	140	100	NR
Hydroquinone .....	••	140	••	185	NR	NR
Hydroxylamine Sulfate .....	••	140	••	••	70	70
Hypochlorous Acid .....	73	140	CF	70	70	••
Iodine .....	NR	NR	NR	70	70	NR
Iodine Solution, 10% .....	NR	NR	NR	200	150	••
Iodine in Alcohol .....	NR	NR	NR	••	••	••
Iron Salts .....	••	••	180	••	••	••
Isopropanol .....	NR	140	NR	••	••	••
Isopropyl Alcohol .....	NR	140	NR	160	140	70
Isopropyl Ether .....	NR	NR	NR	NR	NR	NR
Isooctane .....	NR	NR	NR	185	NR	70
Jet Fuel, JP-4 .....	NR	NR	NR	200	NR	NR
Jet Fuel, JP-5 .....	NR	NR	NR	200	NR	NR
Kerosene .....	NR	NR	NR	200	NR	70
Ketones .....	NR	NR	NR	NR	NR	NR
Kraft Liquor .....	73	140	180	100	••	70
Lactic Acid, 25% .....	73	140	180	70	70	140

Acrylonitrile-Butadiene-Styrene Polyvinyl Chloride Type 1 Grade 1 Chlorinated Polyvinyl Chloride Type IV Grade 1  
 Fluorocarbon Elastomer (Viton® is a registered trademark of the DuPont Co.) Ethylene Propylene Diene Monomer  
 \*\* Maximum recommended temperature, for chemical resistance, under normal conditions. § Non-pressure, vent-only, applications when chemical is in gas form.

# CHEMICAL RESISTANCE

Number = Maximum Recommended Temp. (°F)\*\* CF = Consult Factory NR = Not Recommended •• = Incomplete Data

Chemical Name	Pipe & Fitting Materials Recommended Max. Temp (°F)			Seal Materials Recommended Max. Temp. (°F)		
	ABS	PVC	CPVC	Viton®	EPDM	Neoprene
Lactic Acid, 80% .....	NR	73	73	70	70	••
Lard Oil .....	73	140	NR	185	NR	70
Lauric Acid .....	••	140	••	100	••	••
Lauryl Chloride .....	••	140	••	200	140	••
Lead Acetate .....	••	140	180	NR	200	160
Lead Chloride .....	••	140	180	140	NR	70
Lead Nitrate .....	••	140	180	200	175	140
Lead Sulfate .....	••	140	180	200	200	140
Lemon Oil .....	••	••	NR	200	••	100
Ligroine .....	NR	NR	NR	100	••	70
Lime Sulfur .....	••	140	180	185	200	100
Limonene .....	••	••	NR	••	••	••
Linoleic Acid .....	••	140	180	140	70	••
Linoleic Oil .....	••	140	180	70	••	••
Linseed Oil .....	73	140	NR	200	70	70
Linseed Oil, Blue .....	73	73	NR	200	••	••
Liqueurs .....	NR	140	••	••	••	70
Lithium Bromide (Brine) .....	••	140	180	200	••	••
Lithium Chloride .....	••	140	180	140	100	••
Lithium Sulfate .....	••	140	180	••	••	••
Lubricating Oil, ASTM #1, #2, #3 ...	NR	140	73	150	NR	70
Lux Liquid .....	••	NR	••	••	••	••
Lye Solutions .....	••	140	180	••	••	••
Machine Oil .....	NR	140	180	••	NR	••
Magnesium Carbonate .....	120	140	180	200	170	140
Magnesium Chloride .....	120	140	180	170	170	160
Magnesium Citrate .....	120	140	180	200	175	••
Magnesium Fluoride .....	120	••	180	200	140	••
Magnesium Hydroxide .....	120	140	180	200	200	••
Magnesium Nitrate .....	120	140	180	••	200	••
Magnesium Oxide .....	120	••	180	••	140	160
Magnesium Salts, Inorganic .....	120	••	180	••	••	••
Magnesium Sulfate .....	120	140	180	200	175	160
Maleic Acid .....	160	140	180	200	NR	70
Maleic Acid (Sat'd) .....	160	140	180	200	70	NR
Malic Acid .....	160	140	180	••	••	••
Manganese Sulfate .....	120	140	180	200	175	160
Mercuric Acid .....	••	••	180	••	••	••
Mercuric Chloride .....	••	140	140	185	200	140
Mercuric Cyanide .....	••	140	180	70	70	70
Mercuric Sulfate .....	••	140	180	70	70	••
Mercurous Nitrate .....	••	140	180	70	70	NR
Mercury .....	••	140	180	185	200	140
Methane .....	160§	140§	180§	185	NR	70
Methanol .....	NR	140	NR	NR	140	140

Acrylonitrile-Butadiene-Styrene Polyvinyl Chloride Type 1 Grade 1 Chlorinated Polyvinyl Chloride Type IV Grade 1  
Fluorocarbon Elastomer (Viton® is a registered trademark of the DuPont Co.) Ethylene Propylene Diene Monomer

\*\* Maximum recommended temperature, for chemical resistance, under normal conditions. § Non-pressure, vent-only, applications when chemical is in gas form.

# CHEMICAL RESISTANCE

Number = Maximum Recommended Temp. (°F)\*\* CF = Consult Factory NR = Not Recommended •• = Incomplete Data

Chemical Name	Pipe & Fitting Materials Recommended Max. Temp (°F)			Seal Materials Recommended Max. Temp. (°F)		
	ABS	PVC	CPVC	Viton®	EPDM	Neoprene
Methoxyethyl Oleate .....	NR	73	••	••	••	••
Methyl Amine .....	NR	NR	NR	100	70	70
Methyl Bromide .....	NR	NR	NR	185	NR	NR
Methyl Cellosolve .....	NR	NR	NR	NR	70	70
Methyl Chloride .....	NR	NR	NR	70	NR	NR
Methyl Chloroform .....	NR	NR	NR	70	NR	NR
Methyl Ethyl Ketone .....	NR	NR	NR	NR	70	NR
Methyl Formate .....	NR	••	NR	NR	100	70
Methyl Isobutyl Ketone .....	NR	NR	NR	NR	70	NR
Methyl Methacrylate .....	NR	NR	NR	NR	NR	NR
Methyl Sulfate .....	NR	73	73	••	••	••
Methyl Sulfuric Acid .....	••	140	180	••	••	••
Methylene Bromide .....	NR	NR	NR	70	NR	NR
Methylene Chloride .....	NR	NR	NR	73	NR	NR
Methylene Chlorobromide .....	NR	NR	NR	NR	NR	NR
Methylene Iodine .....	NR	NR	NR	••	200	••
Methylisobutyl Carbinol .....	NR	NR	NR	70	70	70
Milk .....	160	140	73	200	200	160
Mineral Oil .....	73	140	73	200	NR	70
Molasses .....	120	140	180	185	100	150
Monochloroacetic Acid, 50% .....	73	140	73	70	NR	NR
Monoethanolamine .....	NR	NR	NR	185	70	NR
Motor Oil .....	73	140	180	200	NR	••
Muriatic Acid, Up to 30% HCl .....	NR	140	180	••	••	••
Naphtha .....	NR	NR	NR	150	NR	NR
Naphthalene .....	NR	NR	NR	170	NR	NR
n-Heptane .....	NR	NR	NR	••	••	••
Natural Gas .....	NR	140§	••	185	NR	140
Nickel Acetate .....	73	73	180	NR	70	••
Nickel Chloride .....	73	140	180	200	200	160
Nickel Nitrate .....	73	140	180	200	180	••
Nickel Sulfate .....	73	140	180	200	200	160
Nicotine .....	NR	140	••	••	••	NR
Nicotinic Acid .....	NR	140	••	••	70	140
Nitric Acid, 10% .....	73	140	140	185	70	NR
Nitric Acid, 30% .....	NR	140	120	160	70	NR
Nitric Acid, 40% .....	NR	NR	120	140	NR	NR
Nitric Acid, 50% .....	NR	NR	73	120	NR	NR
Nitric Acid, 70% .....	NR	NR	73	100	NR	NR
Nitric Acid, 100% .....	NR	NR	NR	••	••	••
Nitric Acid, Fuming .....	NR	NR	NR	NR	NR	NR
Nitrobenzene .....	NR	NR	NR	70	NR	••
Nitroglycerine .....	NR	NR	NR	••	••	••
Nitrous Acid, 10% .....	NR	73	••	100	••	••
Nitrous Oxide .....	73§	73§	••	70	••	NR

Acrylonitrile-Butadiene-Styrene Polyvinyl Chloride Type 1 Grade 1 Chlorinated Polyvinyl Chloride Type IV Grade 1

Fluorocarbon Elastomer (Viton® is a registered trademark of the DuPont Co.) Ethylene Propylene Diene Monomer

\*\* Maximum recommended temperature, for chemical resistance, under normal conditions. § Non-pressure, vent-only, applications when chemical is in gas form.



# CHEMICAL RESISTANCE

Number = Maximum Recommended Temp. (°F)\*\* CF = Consult Factory NR = Not Recommended •• = Incomplete Data

Chemical Name	Pipe & Fitting Materials Recommended Max. Temp (°F)			Seal Materials Recommended Max. Temp. (°F)		
	ABS	PVC	CPVC	Viton ®	EPDM	Neoprene
Nitroglycol .....	NR	NR	••	••	••	70
Nonionic Surfactants .....	160	140	NR	200	200	160
1-Octanol .....	NR	••	NR	••	••	••
Ocenol .....	NR	••	••	••	••	••
Oils and Fats .....	73	140	••	••	••	••
Oils, Edible .....	73	••	NR	••	••	••
Oils, Vegetable .....	73	••	NR	200	NR	••
Oils, Sour Crude .....	••	••	NR	••	••	••
Oleic Acid .....	160	140	180	185	70	70
Oleum .....	NR	NR	NR	NR	NR	NR
Olive Oil .....	73	140	NR	150	••	140
Oxalic Acid (Sat'd) .....	••	140	140	100	150	100
Oxalic Acid, 20% .....	73	140	180	100	150	100
Oxalic Acid, 50% .....	••	140	73	100	150	100
Oxygen .....	160§	140§	180§	185	200	140
Ozone .....	160§	140§	180§	185	200	NR
Ozonized Water .....	••	••	••	••	••	••
Palm Oil .....	••	••	••	70	NR	••
Palmitic Acid, 10% .....	73	140	73	185	70	NR
Palmitic Acid, 70% .....	NR	NR	73	185	••	NR
Paraffin .....	73	140	••	200	NR	140
Peanut Oil .....	••	••	••	150	NR	••
Pentachlorophenol .....	NR	NR	NR	200	NR	NR
Peppermint Oil .....	NR	73	73	73	73	73
Peracetic Acid, 40% .....	NR	NR	NR	••	••	••
Perchloric Acid, 10% .....	NR	73	73	70	70	70
Perchloric Acid, 70% .....	NR	NR	NR	185	70	NR
Perchloroethylene .....	NR	NR	NR	200	NR	NR
Perphosphate .....	••	140	170	70	70	••
Petrolatum .....	••	140	180	••	••	••
Petroleum Oils, Sour .....	••	73	180	200	NR	••
Petroleum Oils, Refined .....	73	140	180	200	NR	••
Phenol .....	NR	NR	NR	200	70	NR
Phenylhydrazine .....	NR	NR	NR	NR	NR	••
Phenylhydrazine Hydrochloride .....	NR	NR	NR	••	••	••
Phosgene, Liquid .....	NR	NR	NR	NR	73	••
Phosgene, Gas .....	NR	NR	NR	NR	73	••
Phosphoric Acid, 10% .....	73	140	180	200	140	140
Phosphoric Acid, 50% .....	73	140	180	200	70	70
Phosphoric Acid, 85% .....	73	140	180	200	70	NR
Phosphoric Anhydride .....	••	73	73	••	••	••
Phosphorous Pentoxide .....	••	73	180	200	200	••
Phosphorous, Red .....	NR	70	••	••	••	••
Phosphorus Trichloride .....	NR	NR	NR	••	••	NR
Phosphorous, Yellow .....	NR	73	••	••	••	••

Acrylonitrile-Butadiene-Styrene Polyvinyl Chloride Type 1 Grade 1 Chlorinated Polyvinyl Chloride Type IV Grade 1 Fluorocarbon Elastomer (Viton ® is a registered trademark of the DuPont Co.) Ethylene Propylene Diene Monomer

\*\* Maximum recommended temperature, for chemical resistance, under normal conditions. § Non-pressure, vent-only, applications when chemical is in gas form.

# CHEMICAL RESISTANCE

Number = Maximum Recommended Temp. (°F)\*\* CF = Consult Factory NR = Not Recommended •• = Incomplete Data

Chemical Name	Pipe & Fitting Materials Recommended Max. Temp (°F)			Seal Materials Recommended Max. Temp. (°F)		
	ABS	PVC	CPVC	Viton®	EPDM	Neoprene
Photographic Solutions .....	••	140	180	185	••	100
Phthalic Acid, 10% .....	73	73	••	140	••	NR
Picric Acid .....	NR	NR	NR	140	140	70
Pine Oil .....	NR	••	NR	70	••	NR
Plating Solutions, Brass .....	••	140	180	70	70	100
Plating Solutions, Cadmium .....	••	140	180	70	70	100
Plating Solutions, Chrome .....	••	140	180	••	••	R
Plating Solutions, Copper .....	••	140	180	70	70	R
Plating Solutions, Gold .....	••	140	180	70	70	125
Plating Solutions, Indium .....	••	••	••	••	••	••
Plating Solutions, Lead .....	••	140	180	70	70	70
Plating Solutions, Nickel .....	••	140	180	70	70	••
Plating Solutions, Rhodium .....	••	140	180	70	••	••
Plating Solutions, Silver .....	••	140	180	70	70	70
Plating Solutions, Tin .....	••	140	180	140	100	••
Plating Solutions, Zinc .....	••	140	180	70	70	••
Polyethylene Glycol .....	••	••	NR	••	••	••
Polypropylene Glycol .....	••	••	NR	••	••	••
Potash .....	160	140	180	200	170	160
Potassium Acetate .....	••	••	180	••	••	••
Potassium Alum .....	••	140	180	200	200	160
Potassium Aluminum Sulfate .....	••	140	180	200	200	160
Potassium Amyl Xanthate .....	••	73	••	••	••	••
Potassium Bicarbonate .....	160	140	180	200	170	160
Potassium Bichromate .....	160	140	180	200	170	••
Potassium Bisulfate .....	••	••	••	200	170	140
Potassium Borate .....	160	140	180	200	200	••
Potassium Bromate .....	160	140	180	200	••	140
Potassium Bromide .....	160	140	180	200	170	160
Potassium Carbonate .....	160	140	180	200	170	160
Potassium Chlorate .....	160	140	180	140	140	100
Potassium Chloride .....	160	140	180	200	200	160
Potassium Chromate .....	160	140	180	200	170	70
Potassium Cyanide .....	160	140	180	185	140	160
Potassium Dichromate .....	160	140	180	200	170	••
Potassium Ethyl Xanthate .....	••	73	••	••	••	••
Potassium Ferricyanide .....	160	140	180	140	140	150
Potassium Ferrocyanide .....	160	140	180	140	140	150
Potassium Fluoride .....	160	140	180	200	140	••
Potassium Hydroxide .....	160	140	CF	NR	140	160
Potassium Hydroxide, 50% .....	160	140	CF	NR	140	160
Potassium Hypochlorite .....	••	73	180	70	NR	••
Potassium Iodide .....	••	73	180	180	140	160
Potassium Nitrate .....	160	140	180	200	200	140
Potassium Perborate .....	160	140	180	••	••	70

Acrylonitrile-Butadiene-Styrene Polyvinyl Chloride Type 1 Grade 1 Chlorinated Polyvinyl Chloride Type IV Grade 1  
Fluorocarbon Elastomer (Viton® is a registered trademark of the DuPont Co.) Ethylene Propylene Diene Monomer

\*\* Maximum recommended temperature, for chemical resistance, under normal conditions. § Non-pressure, vent-only, applications when chemical is in gas form.

# CHEMICAL RESISTANCE

Number = Maximum Recommended Temp. (°F)\*\* CF = Consult Factory NR = Not Recommended •• = Incomplete Data

Chemical Name	Pipe & Fitting Materials Recommended Max. Temp (°F)			Seal Materials Recommended Max. Temp. (°F)		
	ABS	PVC	CPVC	Viton®	EPDM	Neoprene
Potassium Perchlorate, (Sat'd) .....	160	140	180	150	140	••
Potassium Permanganate, 10% .....	160	140	180	140	200	100
Potassium Permanganate, 25% .....	160	NR	180	140	140	100
Potassium Persulfate, (Sat'd) .....	73	140	180	200	200	140
Potassium Phosphate .....	73	••	180	••	••	••
Potassium Sulfate .....	73	140	180	200	200	140
Potassium Sulfite .....	73	140	180	200	200	140
Potassium Tripolyphosphate .....	••	••	180	100	••	70
Propane .....	160§	140§	73§	70	NR	70
Propanol, Up to 0.5% .....	NR	••	180	••	••	••
Propanol, Over 0.5% .....	NR	••	NR	••	••	••
Propargyl Alcohol .....	NR	140	NR	140	140	NR
Propionic Acid, Up to 2% .....	NR	••	180	••	••	NR
Propionic Acid, Over 2% .....	NR	••	NR	••	••	NR
Propyl Alcohol .....	NR	140	NR	••	140	140
Propylene Dichloride .....	NR	NR	NR	70	NR	NR
Propylene Glycol, Up to 25% .....	73	140	180	140	70	100
Propylene Glycol, Up to 50% .....	73	140	NR	140	70	100
Propylene Oxide .....	NR	NR	NR	NR	70	NR
Pyridine .....	NR	NR	NR	NR	70	NR
Pyrogallia Acid .....	••	73	••	••	••	70
Quaternary Ammonium Salts .....	••	••	NR	••	••	••
Rayon Coagulating Bath .....	••	140	NR	••	••	••
Reverse Osmosis Water .....	160	140	180	200	200	160
Salicylic Acid .....	••	140	180	185	200	NR
Sea Water .....	160	140	180	••	••	••
Selenic Acid .....	••	140	••	••	••	70
Silicic Acid .....	••	140	••	200	140	140
Silicone Oil .....	••	73	150	185	140	70
Silver Chloride .....	160	••	180	••	••	••
Silver Cyanide .....	160	140	180	140	140	70
Silver Nitrate .....	160	140	180	200	200	160
Silver Sulfate .....	160	140	180	200	170	••
Soaps .....	160	140	180	200	200	140
Sodium Acetate .....	120	140	180	NR	170	••
Sodium Aluminate .....	120	••	180	200	200	140
Sodium Alum .....	120	140	180	200	170	140
Sodium Arsenate .....	120	140	180	200	140	70
Sodium Benzoate .....	120	140	180	200	200	••
Sodium Bicarbonate .....	120	140	180	200	200	160
Sodium Bichromate .....	120	140	180	200	140	70
Sodium Bisulfate .....	120	140	180	200	200	140
Sodium Bisulfite .....	120	140	180	200	200	140
Sodium Borate .....	120	73	180	140	140	100
Sodium Bromide .....	120	140	180	200	200	70

Acrylonitrile-Butadiene-Styrene Polyvinyl Chloride Type 1 Grade 1 Chlorinated Polyvinyl Chloride Type IV Grade 1  
Fluorocarbon Elastomer (Viton® is a registered trademark of the DuPont Co.) Ethylene Propylene Diene Monomer

\*\* Maximum recommended temperature, for chemical resistance, under normal conditions. § Non-pressure, vent-only, applications when chemical is in gas form.

# CHEMICAL RESISTANCE

Number = Maximum Recommended Temp. (°F)\*\* CF = Consult Factory NR = Not Recommended •• = Incomplete Data

Chemical Name	Pipe & Fitting Materials Recommended Max. Temp (°F)			Seal Materials Recommended Max. Temp. (°F)		
	ABS	PVC	CPVC	Viton®	EPDM	Neoprene
Sodium Carbonate .....	120	140	180	200	140	140
Sodium Chlorate .....	120	73	180	100	140	140
Sodium Chloride .....	120	140	180	200	140	160
Sodium Chlorite .....	120	NR	180	NR	NR	••
Sodium Chromate .....	120	••	180	70	70	70
Sodium Cyanide .....	120	73	180	140	140	140
Sodium Dichromate .....	120	140	180	200	140	NR
Sodium Ferricyanide .....	120	140	180	140	140	••
Sodium Ferrocyanide .....	120	140	180	140	140	••
Sodium Fluoride .....	120	73	140	140	140	70
Sodium Formate .....	••	••	180	••	••	••
Sodium Hydroxide, 15% .....	120	140	CF	NR	180	160
Sodium Hydroxide, 30% .....	73	73	CF	NR	140	160
Sodium Hydroxide, 50% .....	73	73	CF	NR	140	160
Sodium Hydroxide, 70% .....	NR	73	CF	NR	140	160
Sodium Hypobromite .....	••	••	180	••	••	••
Sodium Hypochlorite, 15% .....	73	73†	180†	185	70	NR
Sodium Hypochlorite (Sat'd) .....	NR	73†	180†	140	NR	NR
Sodium Iodide .....	••	••	180	••	••	160
Sodium Metaphosphate .....	120	73	180	70	70	••
Sodium Nitrate .....	120	140	180	200	200	140
Sodium Nitrite .....	120	140	180	200	170	140
Sodium Palmitrate Solution, 5% .....	120	140	180	••	••	••
Sodium Perborate .....	120	140	180	70	70	70
Sodium Perchlorate .....	120	140	180	••	••	••
Sodium Peroxide .....	••	140	••	185	140	70
Sodium Phosphate, Alkaline .....	73	140	180	200	170	140
Sodium Phosphate, Acid .....	73	140	180	200	170	140
Sodium Phosphate, Neutral .....	73	140	180	200	170	140
Sodium Silicate .....	••	••	180	200	200	140
Sodium Sulfate .....	73	140	180	200	140	140
Sodium Sulfide .....	73	140	180	200	140	140
Sodium Sulfite .....	73	140	180	200	140	140
Sodium Thiosulfate .....	73	140	180	200	200	160
Sodium Tripolyphosphate .....	••	••	180	••	••	••
Solicaldehyde .....	NR	NR	••	••	••	••
Sour Crude Oil .....	NR	140	••	200	NR	NR
Soybean Oil .....	••	••	NR	200	NR	70
Stannic Chloride .....	120	140	180	200	100	NR
Stannous Chloride .....	120	140	180	200	70	160
Stannous Sulfate .....	••	••	180	••	••	••
Starch .....	160	140	180	200	170	160
Stearic Acid .....	••	140	73	100	NR	70
Stoddard's Solvent .....	NR	NR	NR	185	NR	NR
Strontium Chloride .....	••	••	180	••	••	••

Acrylonitrile-Butadiene-Styrene Polyvinyl Chloride Type 1 Grade 1 Chlorinated Polyvinyl Chloride Type IV Grade 1

Fluorocarbon Elastomer (Viton® is a registered trademark of the DuPont Co.) Ethylene Propylene Diene Monomer

\*\* Maximum recommended temperature, for chemical resistance, under normal conditions. § Non-pressure, vent-only, applications when chemical is in gas form.

† Must use sodium hypochlorite resistant cement for making joints.

# CHEMICAL RESISTANCE

Number = Maximum Recommended Temp. (°F)\*\* CF = Consult Factory NR = Not Recommended •• = Incomplete Data

Chemical Name	Pipe & Fitting Materials Recommended Max. Temp (°F)			Seal Materials Recommended Max. Temp. (°F)		
	ABS	PVC	CPVC	Viton ®	EPDM	Neoprene
Styrene .....	NR	••	NR	100	NR	NR
Succinic Acid .....	••	140	••	70	70	••
Sugar .....	120	••	180	200	140	140
Sulfamic Acid .....	NR	NR	180	NR	NR	70
Sulfate Liquors .....	••	••	••	70	70	••
Sulfite Liquor .....	••	••	180	140	140	70
Sulfur .....	••	140	73	200	••	70
Sulfur Chloride .....	••	••	••	70	NR	NR
Sulfur Dioxide, Dry .....	73§	140§	NR	100	70	NR
Sulfur Dioxide, Wet.....	73§	73§	NR	140	140	••
Sulfur Trioxide .....	••	140	180	140	70	NR
Sulfur Trioxide, Gas .....	160§	140§	••	140	70	NR
Sulfuric Acid, 10%.....	120	140	180	200	140	100
Sulfuric Acid, 20%.....	120	140	180	200	140	100
Sulfuric Acid, 30%.....	NR	140	180	200	140	100
Sulfuric Acid, 50%.....	NR	140	180	200	70	NR
Sulfuric Acid, 60%.....	NR	140	180	200	NR	NR
Sulfuric Acid, 70%.....	NR	140	180	200	NR	NR
Sulfuric Acid, 80%.....	NR	73	180	180	NR	NR
Sulfuric Acid, 90%.....	NR	73	73	160	NR	NR
Sulfuric Acid, 94%.....	NR	NR	73	160	NR	NR
Sulfuric Acid, 98%.....	NR	NR	73	160	NR	NR
Sulfuric Acid, 100%.....	NR	••	NR	160	NR	NR
Sulfurous Acid .....	NR	NR	180	100	75	NR
Surfactants, Nonionic .....	160	140	NR	200	200	160
Tall Oil .....	••	140	180	70	NR	70
Tannic Acid, 10% .....	NR	140	180	100	70	100
Tannic Acid, 30% .....	NR	••	73	••	••	••
Tanning Liquors .....	160	140	180	200	••	70
Tar .....	NR	NR	NR	185	NR	70
Tartaric Acid .....	160	140	73	70	NR	70
Terpenes .....	NR	••	NR	••	••	••
Tetrachloroethylene .....	NR	NR	NR	200	NR	NR
Tetraethyl Lead .....	NR	73	••	70	NR	••
Tetrahydrodurane .....	NR	NR	NR	••	••	••
Tetrahydrofuran .....	NR	NR	NR	NR	NR	NR
Tetralin .....	NR	NR	NR	NR	NR	NR
Tetra Sodium Pyrophosphate .....	••	140	180	••	••	••
Texanol .....	••	••	NR	••	••	••
Thionyl Chloride .....	NR	NR	NR	••	••	NR
Thread Cutting Oils .....	73	73	••	70	NR	••
Titanium Tetrachloride .....	NR	NR	NR	185	NR	NR
Toluene, Toluol .....	NR	NR	NR	70	NR	NR
Toluene-Kerosene, 25%-75% .....	NR	NR	NR	••	••	••
Tomato Juice .....	73	73	73	200	200	70

Acrylonitrile-Butadiene-Styrene Polyvinyl Chloride Type 1 Grade 1 Chlorinated Polyvinyl Chloride Type IV Grade 1  
Flouorcarbon Elastomer (Viton ® is a registered trademark of the DuPont Co.) Ethylene Propylene Diene Monomer

\*\* Maximum recommended temperature, for chemical resistance, under normal conditions. § Non-pressure, vent-only, applications when chemical is in gas form.

# CHEMICAL RESISTANCE

Number = Maximum Recommended Temp. (°F)\*\* CF = Consult Factory NR = Not Recommended •• = Incomplete Data

Chemical Name	Pipe & Fitting Materials Recommended Max. Temp (°F)			Seal Materials Recommended Max. Temp. (°F)		
	ABS	PVC	CPVC	Viton®	EPDM	Neoprene
Toxaphene-Xylene, 90%-100% .....	NR	NR	NR	••	••	••
Transformer Oil .....	NR	140	••	140	140	NR
Transformer Oil, DTE/30 .....	NR	••	••	••	NR	NR
Tribute .....	••	••	NR	••	••	••
Tributyl Phosphate .....	NR	NR	NR	NR	70	NR
Tributyl Citrate .....	NR	73	••	••	••	••
Trichloroacetic Acid .....	NR	140	••	NR	70	70
Trichloroethane .....	NR	NR	NR	••	••	••
Trichloroethylene .....	NR	NR	NR	185	NR	NR
Triethanolamine .....	NR	73	NR	NR	70	70
Triethylamine .....	NR	140	••	200	••	70
Trimethylpropane .....	NR	73	••	••	180	160
Trisodium Phosphate .....	73	140	180	185	70	70
Turpentine .....	NR	140	NR	150	NR	NR
Urea .....	73	140	180	185	200	140
Urine .....	160	140	180	70	200	140
Vaseline .....	NR	NR	NR	70	NR	140
Vegetable Oil .....	NR	NR	NR	200	NR	70
Vinegar .....	73	140	180	NR	180	70
Vinegar, White .....	73	140	180	200	200	••
Vinyl Acetate .....	NR	NR	NR	NR	70	NR
Water .....	160	140	180	200	200	160
Water, Acid Mine .....	160	140	180	••	200	160
Water, Deionized .....	NR	140	180	••	200	160
Water, Demineralized .....	NR	140	180	200	200	160
Water, Distilled .....	NR	140	180	••	200	160
Water, Potable .....	NR	140	180	••	200	160
Water, Salt .....	160	140	180	••	200	160
Water, Sea .....	160	140	180	••	200	160
Water, Sewage .....	160	140	180	••	200	••
Water, Swimming Pool .....	NR	73	180	••	••	••
WD 40 .....	NR	••	NR	••	••	••
Whiskey .....	NR	140	180	140	200	140
White Liquor .....	73	140	180	••	••	140
Wines .....	NR	140	180	140	170	140
Xylene .....	NR	NR	NR	150	NR	NR
Zinc Acetate .....	••	140	180	70	180	160
Zinc Bromide .....	••	140	180	••	••	••
Zinc Carbonate .....	120	••	180	••	••	••
Zinc Chloride .....	120	140	180	200	180	160
Zinc Nitrate .....	120	140	180	200	180	••
Zinc Phosphate .....	••	••	180	••	••	••
Zinc Sulfate .....	••	140	180	200	180	140

Acrylonitrile-Butadiene-Styrene Polyvinyl Chloride Type 1 Grade 1 Chlorinated Polyvinyl Chloride Type IV Grade 1 Fluorocarbon Elastomer (Viton® is a registered trademark of the DuPont Co.) Ethylene Propylene Diene Monomer

\*\* Maximum recommended temperature, for chemical resistance, under normal conditions. § Non-pressure, vent-only, applications when chemical is in gas form.

# ABS "FOAM CORE" SCHEDULE 40 DWV PIPE AND ABS DWV FITTINGS FACT SHEET

## System

- ABS "Foam Core" Schedule 40 DWV pipe and ABS DWV Fittings

## Standards

- ASTM F 628 "Foam Core" ABS DWV Pipe
- ASTM D 2661 ABS DWV Fittings
- NSF Standard 14 Dimensional Standard

## Cell Class

- 42222 "Foam Core" ABS DWV Pipe per ASTM D 3965
- 32222 ABS DWV Fittings per ASTM D 3965

## Maximum Working Temperature

- 160 Degrees Fahrenheit

## Maximum Working Pressure

- 0 (Zero) PSI
- ABS DWV is not a pressure rated piping system.
- Recommended test is 10 feet of hydrostatic (water) pressure, which is equal to 4.3 PSI.

## Joining Method

- Solvent Weld Joints
- Solvent Cement must meet ASTM D 2235.
- Primer is not recommended.

## Threaded Joint

- Threading ABS Schedule 40 "Foam Core" pipe is not recommended.
- Only join to threaded components conforming to ANSI/ASME B1.20.1 or ASTM F 1498.
- Use Teflon tape. Teflon tape is recommended for all threaded connections and should be a .4 minimum density, .003" thick, .50% elongation and chemically inert. To apply start with two wraps at fitting end, wrap all threads overlapping half the width of the tape in the direction of the threads on each wind.
- Avoid over-tightening as this may cause damage to the thread or the fitting.
- When combining plastic and metal threaded systems, it is recommended that plastic male threads be screwed into metal female threads rather than metal male threads into plastic female threads.

## Transition to Cast Iron Soil Pipe

- Transition fittings to No Hub and Service are available and recommended.

## Thermal Expansion

- .66 inches per 10 degree temperature change per 100 foot of pipe

## Special Considerations

- Do **NOT** air test.
- Consult chemical resistant chart for chemical compatibility.
- U.V. sensitivity. Do not install permanently in direct sunlight without painting with water-based latex paint, or covering with pipe insulation.

# ABS "FOAM CORE" SCHEDULE 40 DWV PIPE AND ABS DWV FITTINGS FACT SHEET

## System

**ABS "Foam Core" Schedule 40 DWV Pipe & ABS Fittings.**

## Product Offering / Data

Size	Product	Available Lengths	OD	Nominal ID	Min. Wall	Weight Per 100 Ft. (lbs.)
1½"	Plain End	10' & 20'	1.900	1.59	0.156	28.0
2"	IPS Pipe	10' & 20'	2.375	2.06	0.156	36.8
3"		10' & 20'	3.500	3.06	0.218	76.5
4"		10' & 20'	4.500	4.00	0.250	108.8
6"		10' & 20'	6.625	6.06	0.281	187.5

## Minimum Cure Time to Test

Size	60° - 100°F	40° - 60°F	0° - 40°F
1½" to 3"	2 Hours	4 Hours	16 Hours
4" & 6"	6 Hours	12 Hours	48 Hours

- Cure times shown are sufficient to complete a test at 10 feet of hydrostatic pressure (4.3 pounds per square inch.) Full cure may take significantly longer.
- Cure times are a function of air temperature, fluid temperature, humidity, and pipe size. Increase the cure time for more demanding conditions.

## Flame Spread and Smoke Rating for ABS

- ASTM E 84 is the test protocol cited in the Uniform Mechanical Code and International Mechanical Code to determine a material's suitability for installation in a plenum area.
- Per ASTM E 84, ABS does not meet the 25/50 flame and smoke requirement for plenum application.
- Always follow prevailing code requirements.



# PVC "SOLID WALL" SCHEDULE 40 DWV PIPE AND PVC DWV FITTINGS FACT SHEET

## System

- PVC Schedule 40 Pipe and Fittings

## Standards

- ASTM D 1785 Schedule 40 PVC Plain End Pipe
- ASTM D 2665 Schedule 40 PVC DWV Fittings
- NSF Standard 14 Dimensional Standard
- NSF Standard 61 Health Effects

## Cell Class

- 12454 PVC DWV Pipe and Fittings per ASTM D 1784

## Maximum Working Temperature

- 140 Degrees Fahrenheit

## Maximum Working Pressure

- 0 (Zero) PSI
- PVC DWV is not a pressure rated piping system.
- Recommended test is 10 feet of hydrostatic (water) pressure, which is equal to 4.3 PSI.

## Joining Method

- Solvent Weld Joints
- Solvent Cement must meet ASTM D 2564.
- Primer is required.

## Threaded Joint

- Threading PVC Schedule 40 pipe is not recommended.
- Only join to threaded components conforming to ANSI/ASME B1.20.1 or ASTM F 1498.
- Use Teflon tape. Teflon tape is recommended for all threaded connections and should be a .4 minimum density, .003" thick, .50% elongation and chemically inert. To apply start with two wraps at fitting end, wrap all threads overlapping half the width of the tape in the direction of the threads on each wind.
- Avoid over-tightening as this may cause damage to the thread or the fitting.

- When combining plastic and metal threaded systems, it is recommended that plastic male threads be screwed into metal female threads rather than metal male threads into plastic female threads.

Installation of Brass and PVC Threaded Fittings			
Pipe Size	Torque Setting		Teflon Tape
	Brass Threaded Fittings	PVC Threaded Fittings	
1/2"	14 ft.lbs.	3 to 5 ft.lbs.	1/2" width
3/4"	18 ft.lbs.	4 to 6 ft.lbs.	1/2" width
1"	24 ft.lbs.	5 to 7 ft.lbs.	1/2" width
1 1/4"	30 to 60 ft.lbs.	5 to 7 ft.lbs.	1" width
1 1/2"	23 to 34 ft.lbs.	6 to 8 ft.lbs.	1" width
2"	36 to 50 ft.lbs.	8 to 10 ft.lbs.	1" width

Note: 1 foot pound = 12 inch pounds

## Transition to Cast Iron Soil Pipe

- Transition fittings to No Hub and Service are available and recommended.

## Thermal Expansion

- .360 inches per 10 degree temperature change per 100 foot of pipe

## Special Considerations

- Do **NOT** air test.
- Consult chemical resistant chart for chemical compatibility.
- U.V. sensitivity. Do not install permanently in direct sunlight without painting with water-based latex paint, or covering with pipe insulation.

# PVC "SOLID WALL" SCHEDULE 40 DWV PIPE AND PVC DWV FITTINGS FACT SHEET

## Flame Spread and Smoke Rating for PVC

- PVC piping systems are self extinguishing and will not support combustion. ASTM E 84 is the test protocol cited in the Uniform Mechanical Code and International Mechanical Code to determine a material's suitability for installation in a plenum area.
- Per ASTM E 84, PVC does not meet the 25/50 flame and smoke requirement for plenum application.
- PVC piping systems comply with self extinguishing requirements of ASTM D 635.
- PVC piping systems meet the V-0 burning class requirements of UL 94.
- Always follow prevailing code requirements.

## Minimum Cure Time to Test

Size	60° - 100°F	40° - 60°F	0° - 40°F
1½" to 3"	2 Hours	4 Hours	16 Hours
4" to 8"	6 Hours	12 Hours	48 Hours
10" to 12"	24 Hours	40 Hours	8 Days

- Cure times shown are sufficient to complete a test at 10 feet of hydrostatic pressure (4.3 pounds per square inch.) Full cure may take significantly longer.
- Cure times are a function of air temperature, fluid temperature, humidity, and pipe size. Increase the cure time for more demanding conditions.

## System

### PVC Schedule 40 (Solid Wall) Pipe & Fittings Product Offering / Data

Size	Product	Available Lengths	OD	Nominal ID	Min. Wall	Weight Per 100 Ft. (lbs.)
1¼"	Plain End	10' & 20'	1.660	1.380	0.140	42.0
1½"	IPS Pipe	10' & 20'	1.900	1.610	0.145	50.4
2"		10' & 20'	2.375	2.067	0.154	67.6
2½"		20'	2.875	2.469	0.203	107.0
3"		10' & 20'	3.500	3.068	0.216	141.0
4"		10' & 20'	4.500	4.026	0.237	200.0
5"		20'	5.563	5.047	0.258	272.5
6"		10' & 20'	6.625	6.065	0.280	352.0
8"		20'	8.625	7.981	0.322	539.0
10"		20'	10.750	10.020	0.365	755.0
12"		20'	12.750	11.938	0.406	1001.0
14"		20'	14.000	13.124	0.437	1180.1
16"		20'	16.000	15.000	0.500	1543.1

# PVC "FOAM CORE" SCHEDULE 40 DWV PIPE AND PVC DWV FITTINGS FACT SHEET

## System

- PVC "Foam Core" Schedule 40 DWV pipe and PVC DWV Fittings

## Standards

- ASTM F 891 "Foam Core" PVC DWV Pipe
- ASTM D 2665 PVC DWV Fittings
- NSF Standard 14 Dimensional Standard

## Cell Class

- 11432 "Foam Core" PVC DWV Pipe per ASTM D 4396
- 12454-B PVC DWV Fittings per ASTM D 1784

## Maximum Working Temperature

- 140 Degrees Fahrenheit

## Maximum Working Pressure

- 0 (Zero) PSI
- PVC DWV is not a pressure rated piping system.
- Recommended test is 10 feet of hydrostatic (water) pressure, which is equal to 4.3 PSI.

## Joining Method

- Solvent Weld Joints
- Solvent Cement must meet ASTM D 2564.
- Primer is required.

## Threaded Joint

- Threading PVC Schedule 40 "Foam Core" pipe is not recommended.
- Only join to threaded components conforming to ANSI/ASME B1.20.1 or ASTM F 1498.
- Use Teflon tape. Teflon tape is recommended for all threaded connections and should be a .4 minimum density, .003" thick, .50% elongation and chemically inert. To apply start with two wraps at fitting end, wrap all threads overlapping half the width of the tape in the direction of the threads on each wind.

- Avoid over-tightening as this may cause damage to the thread or the fitting.
- When combining plastic and metal threaded systems, it is recommended that plastic male threads be screwed into metal female threads rather than metal male threads into plastic female threads.

Installation of Brass and PVC Threaded Fittings			
Pipe Size	Torque Setting		Teflon Tape
	Brass Threaded Fittings	PVC Threaded Fittings	
1/2"	14 ft.lbs.	3 to 5 ft.lbs.	1/2" width
3/4"	18 ft.lbs.	4 to 6 ft.lbs.	1/2" width
1"	24 ft.lbs.	5 to 7 ft.lbs.	1/2" width
1 1/4"	30 to 60 ft.lbs.	5 to 7 ft.lbs.	1" width
1 1/2"	23 to 34 ft.lbs.	6 to 8 ft.lbs.	1" width
2"	36 to 50 ft.lbs.	8 to 10 ft.lbs.	1" width

Note: 1 foot pound = 12 inch pounds

## Transition Fittings

- Transition fittings to No Hub and Service are available and recommended.

## Thermal Expansion

- .360 inches per 10 degree temperature change per 100 foot of pipe

## Special Considerations

- Do **NOT** air test.
- Consult chemical resistant chart for chemical compatibility.
- U.V. sensitivity. Do not install permanently in direct sunlight without painting with water-based latex paint, or covering with pipe insulation.

# PVC "FOAM CORE" SCHEDULE 40 DWV PIPE AND PVC DWV FITTINGS FACT SHEET

## Flame Spread and Smoke Rating for PVC

- PVC piping systems are self extinguishing and will not support combustion. ASTM E 84 is the test protocol cited in the Uniform Mechanical Code and International Mechanical Code to determine a material's suitability for installation in a plenum area.
- Per ASTM E 84, PVC does not meet the 25/50 flame and smoke requirement for plenum application.
- PVC piping systems comply with self extinguishing requirements of ASTM D 635.
- PVC piping systems meet the V-0 burning class requirements of UL 94.
- Always follow prevailing code requirements.

## Minimum Cure Time to Test

Size	60° - 100°F	40° - 60°F	0° - 40°F
1½" to 3"	2 Hours	4 Hours	16 Hours
4" to 8"	6 Hours	12 Hours	48 Hours
10" to 12"	24 Hours	40 Hours	8 Days

- Cure times shown are sufficient to complete a test at 10 feet of hydrostatic pressure (4.3 pounds per square inch.) Full cure may take significantly longer.
- Cure times are a function of air temperature, fluid temperature, humidity, and pipe size. Increase the cure time for more demanding conditions.

## System

### PVC Schedule 40 "Foam Core" Pipe & Fittings.

#### Product Offering / Data

Size	Product	Available Lengths	OD	Nominal ID	Min. Wall	Bell Depth	Weight Per 100 Ft. (lbs.)
1½"	Plain End	10' & 20'	1.900	1.610	0.145		38.1
2"	IPS Pipe	10' & 20'	2.375	2.067	0.154		51.2
3"		10' & 20'	3.500	3.068	0.216		105.0
4"		10' & 20'	4.500	4.026	0.237		146.0
6"		10' & 20'	6.625	6.065	0.280		247.0
8"		20'	8.625	7.981	0.322		371.0
10"		20'	10.750	10.020	0.365		566.0
12"		20'	12.750	11.938	0.406		755.0
3"	Bell End	20'	3.500	3.068	0.216	4.00	105.0
4"	IPS Pipe	10' & 20'	4.500	4.026	0.237	5.00	146.0
6"		20'	6.625	6.065	0.280	6.50	247.0

**Note:** See separate sheet for ASTM F 480 & ASTM D 2241 Bell End Well Casing.

# PVC SCHEDULE 40 PIPE AND FITTINGS FACT SHEET

## System

- PVC Schedule 40 Pipe and Fittings

## Standards

- ASTM D 1785 Schedule 40 PVC Plain End Pipe
- ASTM D 2665 Schedule 40 Dual Marked Pipe
- ASTM F 480 Schedule 40 Bell End Well Casing
- ASTM D 2466 Schedule 40 Fittings
- NSF Standard 14 Dimensional Standard
- NSF Standard 61 Health Effects

## Cell Class

- 12454 (Type 1, Grade 1) PVC 1120 per ASTM D 1784

## Maximum Working Temperature

- 140 Degrees Fahrenheit
- The De-rating factor must be used to determine the pressure rating for each pipe diameter for temperatures over 73°F.

## Maximum Working Pressure

- See pipe diameter chart.

## Joining Method

- Solvent Weld Joints
- Solvent Cement must meet ASTM D 2564.
- Primer is required.

## Cure Times

- Cure times are a function of air temperature, water temperature, humidity, and pipe size. Increase the cure time for colder temperatures or higher humidity. See cure time chart on page 75.

## Threaded Joint

- Threading PVC Schedule 40 pipe is **not** recommended.
- Only join to threaded components conforming to ANSI/ASME B1.20.1 or ASTM F 1498.
- Use Teflon tape. Teflon tape is recommended for all threaded connections and should be a .4 minimum density, .003" thick, .50% elongation and chemically inert. To apply start with two wraps at fitting end, wrap all threads overlapping half the width of the tape in the direction of the threads on each wind.
- Avoid over-tightening as this may cause damage to the thread or the fitting.
- When combining plastic and metal threaded systems, it is recommended that plastic male

threads be screwed into metal female threads rather than metal male threads into plastic female threads.

Installation of Brass and PVC Threaded Fittings			
Pipe Size	Torque Setting		Teflon Tape
	Brass Threaded Fittings	PVC Threaded Fittings	
1/2"	14 ft.lbs.	3 to 5 ft.lbs.	1/2" width
3/4"	18 ft.lbs.	4 to 6 ft.lbs.	1/2" width
1"	24 ft.lbs.	5 to 7 ft.lbs.	1/2" width
1 1/4"	30 to 60 ft.lbs.	5 to 7 ft.lbs.	1" width
1 1/2"	23 to 34 ft.lbs.	6 to 8 ft.lbs.	1" width
2"	36 to 50 ft.lbs.	8 to 10 ft.lbs.	1" width

Note: 1 foot pound = 12 inch pounds

## Mechanical Joints

- May be made with schedule 80 flanges or unions
- May be roll grooved

## Thermal Expansion

- .360 inches per 10 degree temperature change per 100 foot of pipe

## Temperature De-rating Factor

Temperature	De-Rating Factor	Temperature	De-Rating Factor
73°F	1.00	120°F	0.40
80°F	0.88	125°F	0.35
90°F	0.75	130°F	0.30
100°F	0.62	140°F	0.22

Principle: As the fluid temperature increases, the pipe's ability to hold pressure decreases.

Method: To find the pressure rating at a required temperature, multiply the cold water (73°F) pressure rating by the de-rating factor.

Example: Solve for 2" PVC-40 at 100°F.  
0.62 x 280 PSI = 173 PSI

## Special Considerations

- Do **NOT** air test.
- Consult chemical resistant chart for chemical compatibility.
- U.V. sensitivity. Do not install permanently in direct sunlight without painting with water-based latex paint, or covering with pipe insulation.

# PVC SCHEDULE 40 PIPE AND FITTINGS FACT SHEET

## Flame Spread and Smoke Rating for PVC

- PVC piping systems are self extinguishing and will not support combustion. ASTM E 84 is the test protocol cited in the Uniform Mechanical Code and International Mechanical Code to determine a material's suitability for installation in a plenum area.

- Per ASTM E 84, PVC does not meet the 25/50 flame and smoke requirement for plenum application.
- PVC piping systems comply with self extinguishing requirements of ASTM D 635.
- PVC piping systems meet the V-0 burning class requirements of UL 94.
- Always follow prevailing code requirements.

## System

### PVC Schedule 40 Pipe. Product Offering / Data

Size	Product	Available Lengths	OD	Nominal ID	Min. Wall	Bell Depth	Weight Per 100 Ft. (lbs.)	Max Work PSI 73°F (23°C)
1/2"	Plain End IPS Pipe	20'	0.840	0.622	0.109		15.700	600
3/4"		20'	1.050	0.824	0.113		21.000	480
1"		20'	1.315	1.049	0.133		31.000	450
1 1/4"		10' & 20'	1.660	1.380	0.140		42.000	370
1 1/2"		10' & 20'	1.900	1.610	0.145		50.400	330
2"		10' & 20'	2.375	2.067	0.154		67.600	280
2 1/2"		20'	2.875	2.469	0.203		107.000	300
3"		10' & 20'	3.500	3.068	0.216		141.000	260
4"		10' & 20'	4.500	4.026	0.237		200.000	220
5"		20'	5.563	5.047	0.258		272.500	190
6"		10' & 20'	6.625	6.065	0.280		352.000	180
8"		20'	8.625	7.981	0.322		539.000	160
10"		20'	10.750	10.020	0.365		755.000	140
12"		20'	12.750	11.938	0.406		1001.000	130
14"		20'	14.000	13.124	0.437		1180.100	130
16"		20'	16.000	15.000	0.500		1543.100	130
1/2"	Bell End IPS Pipe	20'	0.840	0.622	0.109	2.00	15.700	600
3/4"		20'	1.050	0.824	0.113	2.25	21.000	480
1"		20'	1.315	1.049	0.133	2.50	31.000	450
1 1/4"		20'	1.660	1.380	0.140	2.75	42.000	370
1 1/2"		20'	1.900	1.610	0.145	3.00	50.400	330
2"		20'	2.375	2.067	0.154	4.00	67.600	280
2 1/2"		20'	2.875	2.469	0.203	4.00	107.000	300
3"		10' & 20'	3.500	3.068	0.216	4.00	144.300	260
4"		10' & 20'	4.500	4.026	0.237	5.00	205.900	220
6"		10' & 20'	6.625	6.065	0.280	6.50	365.100	180
8"		20'	8.625	7.981	0.322	7.00	558.800	160
10"		20'	10.750	10.020	0.365	9.00	761.000	140
12"		20'	12.750	11.938	0.406	10.00	1045.000	130
14"		20'	14.000	13.124	0.437	10.00	1187.000	130
16"		20'	16.000	15.000	0.500	10.00	1543.100	130
2"		Bell End IPS Well Casing	20'	2.375	2.067	0.154	4.00	67.600
2 1/2"	20'		2.875	2.469	0.203	4.00	107.000	300
3"	20'		3.500	3.068	0.216	4.00	144.300	260
4"	20'		4.500	4.026	0.237	5.00	205.900	220
6"	20'		6.625	6.065	0.280	6.50	365.100	180
8"	20'		8.625	7.981	0.322	7.00	558.800	160

**Note:** See separate sheet for ASTM F 480 & ASTM D 2241 Bell End Well Casing.

# PVC SCHEDULE 80 PIPE AND FITTINGS FACT SHEET

## System

- PVC Schedule 80 Pipe and Fittings

## Standards

- ASTM D 1785 Schedule 80 PVC Plain End Pipe
- ASTM D 2464 and ASTM D 2467 PVC Schedule 80 Fittings
- NSF Standard 14 Dimensional Standard
- NSF Standard 61 Health Effects

## Cell Class

- 12454 (Type 1, Grade 1) PVC 1120 per ASTM D 1784

## Maximum Working Temperature

- 140 Degrees Fahrenheit
- The De-rating factor must be used to determine the pressure rating for each pipe diameter for temperatures over 73°F.

## Maximum Working Pressure

- See pipe diameter chart.

## Joining Method

- Solvent Weld Joints
- Solvent Cement must meet ASTM D 2564.
- Primer is required.

## Cure Times

- Cure times are a function of air temperature, water temperature, humidity, and pipe size. Increase the cure time for colder temperatures or higher humidity. See cure chart on page 75.

## Threaded Joint

- 1/4" - 4" PVC Schedule 80 pipe can be safely threaded. Threading will result in 50% reduction in pressure capability.
- Only join to threaded components conforming to ANSI/ASME B1.20.1 or ASTM F 1498.
- Use Teflon tape. Teflon tape is recommended for all threaded connections and should be a .4 minimum density, .003" thick, .50% elongation and chemically inert. To apply start with two wraps at fitting end, wrap all threads overlapping half the width of the tape in the direction of the threads on each wind.
- Avoid over-tightening as this may cause damage to the thread or the fitting.
- When combining plastic and metal threaded systems, it is recommended that plastic male

threads be screwed into metal female threads rather than metal male threads into plastic female threads.

Installation of Brass and PVC Threaded Fittings			
Pipe Size	Torque Setting		Teflon Tape
	Brass Threaded Fittings	PVC Threaded Fittings	
1/2"	14 ft.lbs.	3 to 5 ft.lbs.	1/2" width
3/4"	18 ft.lbs.	4 to 6 ft.lbs.	1/2" width
1"	24 ft.lbs.	5 to 7 ft.lbs.	1/2" width
1 1/4"	30 to 60 ft.lbs.	5 to 7 ft.lbs.	1" width
1 1/2"	23 to 34 ft.lbs.	6 to 8 ft.lbs.	1" width
2"	36 to 50 ft.lbs.	8 to 10 ft.lbs.	1" width

Note: 1 foot pound = 12 inch pounds

## Mechanical Joints

- May be made with schedule 80 flanges or unions
- May be roll grooved

## Thermal Expansion

- .360 inches per 10 degree temperature change per 100 foot of pipe

## Temperature De-rating Factor - PVC

Temperature	De-Rating Factor	Temperature	De-Rating Factor
73°F	1.00	120°F	0.40
80°F	0.88	125°F	0.35
90°F	0.75	130°F	0.30
100°F	0.62	140°F	0.22

Principle: As the fluid temperature increases, the pipe's ability to hold pressure decreases.

Method: To find the pressure rating at a required temperature, multiply the cold water (73°F) pressure rating by the de-rating factor.

Example: Solve for 2" PVC-80 at 100°F.  
0.62 x 400 PSI = 248 PSI

## Special Considerations

- Do **NOT** air test.
- Consult chemical resistant chart for chemical compatibility.
- U.V. sensitivity. Do not install permanently in direct sunlight without painting with water-based latex paint, or covering with pipe insulation.

# PVC SCHEDULE 80 PIPE AND FITTINGS FACT SHEET

## Flame Spread and Smoke Rating for PVC

• PVC piping systems are self extinguishing and will not support combustion. ASTM E 84 is the test protocol cited in the Uniform Mechanical Code and International Mechanical Code to determine a material's suitability for installation in a plenum area.

- Per ASTM E 84, PVC does not meet the 25/50 flame and smoke requirement for plenum application.
- PVC piping systems comply with self extinguishing requirements of ASTM D 635.
- PVC piping systems meet the V-0 burning class requirements of UL 94.
- Always follow prevailing code requirements.

## System

### PVC Schedule 80 Pipe Product Offering / Data

Size	Product	Available Lengths	OD	Nominal ID	Min. Wall	Bell Length	Weight Per 100 Ft. (lbs.)	Max Work PSI 73°F (23°C)
1/4"	Plain End IPS Pipe (Gray)	20'	0.540	0.302	0.119		10.0	1130
3/8"		20'	0.675	0.423	0.126		13.8	920
1/2"		20'	0.840	0.546	0.147		20.4	850
3/4"		20'	1.050	0.742	0.154		27.0	690
1"		20'	1.315	0.957	0.179		41.0	630
1 1/4"		20'	1.660	1.278	0.191		52.2	520
1 1/2"		20'	1.900	1.500	0.200		66.8	470
2"		20'	2.375	1.939	0.218		94.5	400
2 1/2"		20'	2.875	2.323	0.276		144.5	420
3"		20'	3.500	2.900	0.300		194.2	370
4"		20'	4.500	3.826	0.337		275.2	320
5"		20'	5.563	4.813	0.375		387.3	290
6"		20'	6.625	5.761	0.432		541.5	280
8"		20'	8.625	7.625	0.500		805.2	250
10"		20'	10.750	9.564	0.593		1200.0	230
12"		20'	12.750	11.376	0.687		1650.0	230
14"	20'	14.000	12.500	0.750		1930.0	220	
16"	20'	16.000	14.314	0.843		2544.1	220	
1/2"	Bell End IPS Pipe (Gray)	20'	0.840	0.546	0.147	1.00	20.5	850
3/4"		20'	1.050	0.742	0.154	1.25	27.5	690
1"		20'	1.315	0.957	0.179	1.50	40.9	630
1 1/4"		20'	1.660	1.278	0.191	1.75	55.7	520
1 1/2"		20'	1.900	1.500	0.200	2.00	68.6	470
2"		20'	2.375	1.939	0.218	2.25	94.9	400
2 1/2"		20'	2.875	2.323	0.276	2.50	142.1	420
3"		20'	3.500	2.900	0.300	3.25	193.8	370
4"		20'	4.500	3.826	0.337	4.00	283.3	320
6"		20'	6.625	5.761	0.432	6.00	541.1	280
8"		20'	8.625	7.625	0.500	6.00	805.2	250
10"		20'	10.750	9.564	0.593	7.50	1200.0	230
12"		20'	12.750	11.376	0.687	8.50	1650.0	230
14"		20'	14.000	12.500	0.750	9.00	2010.0	220
16"		20'	16.000	14.314	0.843	9.00	2544.1	220



# CPVC SCHEDULE 80 PIPE AND FITTINGS FACT SHEET

## System

- Corzan CPVC Schedule 80 Pipe and Fittings

## Standards

- ASTM F 441 Schedule 80 CPVC Plain End Pipe
- ASTM F 437 Schedule 80 Threaded Fittings
- ASTM F 439 Schedule 80 Fittings
- NSF Standard 14 Dimensional Standard
- NSF Standard 61 Health Effects

## Cell Class

- 24448 or 23447 (Type IV, Grade 1) CPVC 4120 per ASTM D 1784

## Maximum Working Temperature

- 200 Degrees Fahrenheit
- The De-rating factor must be used to determine the pressure rating for each pipe diameter for temperatures over 73°F.

## Maximum Working Pressure

- See pipe diameter chart.

## Joining Method

- Solvent Weld Joints
- Solvent Cement must meet ASTM F 493.
- Primer is required.

## Minimum Cure Time to Test at 180 PSI

Size	60° - 100°F	40° - 60°F	0° - 40°F
1/2" to 1 1/4"	1 Hour	2 Hours	8 Hours
1 1/2" to 3"	2 Hours	4 Hours	16 Hours
4" to 8"	6 Hours	12 Hours	48 Hours
10" to 16"	24 Hours	40 Hours	8 Days

- Cure times are a function of air temperature, water temperature, humidity, and pipe size. Increase the cure time for more demanding conditions.

## Threaded Joint

- 1/4" - 4" Schedule 80 pipe can be safely threaded. Threading will result in 50% reduction in pressure capability.
- Only join to threaded components conforming to ANSI/ASME B1.20.1 or ASTM F 1498.
- Use Teflon tape. Teflon tape is recommended for all threaded connections and should be a .4

minimum density, .003" thick, .50% elongation and chemically inert. To apply start with two wraps at fitting end, wrap all threads overlapping half the width of the tape in the direction of the threads on each wind.

- Avoid over-tightening as this may cause damage to the thread or the fitting.
- When combining plastic and metal threaded systems, it is recommended that plastic male threads be screwed into metal female threads rather than metal male threads into plastic female threads.

Installation of Brass and CPVC Threaded Fittings			
Pipe Size	Torque Setting		Teflon Tape
	Brass Threaded Fittings	CPVC Threaded Fittings	
1/2"	14 ft.lbs.	3 to 5 ft.lbs.	1/2" width
3/4"	18 ft.lbs.	4 to 6 ft.lbs.	1/2" width
1"	24 ft.lbs.	5 to 7 ft.lbs.	1/2" width
1 1/4"	30 to 60 ft.lbs.	5 to 7 ft.lbs.	1" width
1 1/2"	23 to 34 ft.lbs.	6 to 8 ft.lbs.	1" width
2"	36 to 50 ft.lbs.	8 to 10 ft.lbs.	1" width

Note: 1 foot pound = 12 inch pounds

## Mechanical Joints

- May be made with schedule 80 flanges or unions

## Temperature De-rating Factor - CPVC

Temperature	De-Rating Factor	Temperature	De-Rating Factor
73°F	1.00	130°F	0.62
80°F	1.00	140°F	0.50
90°F	0.91	160°F	0.40
100°F	0.82	180°F	0.25
120°F	0.65	200°F	0.20
125°F	0.66		

Principle: As the fluid temperature increases, the pipe's ability to hold pressure decreases.

Method: To find the pressure rating at a required temperature, multiply the cold water (73°F) pressure rating by the de-rating factor.

Example: Solve for 2" CPVC-80 at 100°F.  
0.82 x 400 PSI = 328 PSI

# CORZAN® CPVC SCHEDULE 80 PIPE AND FITTINGS FACT SHEET

## Thermal Expansion

- .408 inches per 10 degree temperature change per 100 foot of pipe

## Special Considerations

- Do **NOT** air test.
- Consult chemical resistant chart for chemical compatibility.
- U.V. sensitivity; Do not install permanently in direct sunlight without painting with water-based latex paint, or covering with pipe insulation.

## Flame Spread and Smoke Rating for CPVC

- CPVC piping systems are self extinguishing and will not support combustion. ASTM E 84 is the test protocol cited in the Uniform Mechanical Code and International Mechanical Code to determine a material's suitability for installation in a plenum area.
- Per ASTM E 84, CPVC in sizes 1/2" through 6", water filled, meets the 25/50 flame and smoke requirement for plenum application.
- CPVC piping systems comply with self extinguishing requirements of ASTM D 635.
- CPVC piping systems meet the V-0 burning class requirements of UL 94.
- Always follow prevailing code requirements.

## System

### CPVC Schedule 80 Pipe.

### Product Offering / Data

Size	Product	Available Lengths	OD	Nominal ID	Min. Wall	Weight Per 100 Ft. (lbs.)	Max Work PSI 73°F (23°C)
1/4"	Sch. 80	20'	0.540	0.302	0.119	10.9	1130
3/8"	Plain End	20'	0.675	0.423	0.126	15.0	920
1/2"	IPS Pipe (Gray)	20'	0.840	0.546	0.147	22.1	850
3/4"		20'	1.050	0.742	0.154	30.0	690
1"		20'	1.315	0.957	0.179	44.2	630
1 1/4"		20'	1.660	1.278	0.191	61.0	520
1 1/2"		20'	1.900	1.500	0.200	73.9	470
2"		20'	2.375	1.939	0.218	102.2	400
2 1/2"		20'	2.875	2.323	0.276	155.9	420
3"		20'	3.500	2.900	0.300	208.6	370
4"	20'	4.500	3.826	0.337	304.9	320	
6"	20'	6.625	5.761	0.432	581.5	280	
8"	20'	8.625	8.625	0.500	882.9	250	

# FLOWGUARD GOLD® COPPER TUBE SIZE (CTS) CPVC SDR 11 PIPE AND FITTINGS FACT SHEET

CHARLOTTE PIPE AND FOUNDRY COMPANY®

## System

- FlowGuard Gold® Copper Tube Size CPVC SDR 11 Pipe and Fittings for Hot and Cold Water Systems

## Standards

- ASTM D 2846 SDR 11 Pipe and Fittings
- ASTM F 493 Solvent Cement
- NSF Standard 14 Dimensional Standard
- NSF Standard 61 Health Effects

## Cell Class

- 24448 (Type IV, Grade 1) CPVC 4120 per ASTM D 1784

## Maximum Working Temperature

- 180 Degrees Fahrenheit

## Maximum Working Pressure

- 400 PSI at 73 Degrees Fahrenheit
- 100 PSI at 180 Degrees Fahrenheit
- See De-rating Factor chart next page.

## Joining Method

- Solvent Weld Joints
- Solvent Cement must meet ASTM F 493.
- **Where approved by code**, yellow one step cement may be used without primer.
- All other solvent cements must be used with primer.

## Cure Times

- Cure times are a function of air temperature, water temperature, humidity, and pipe size. Increase the cure time for colder temperatures or higher humidity. See cure times chart on 80.

## Threaded Joint

- Threading the pipe is not recommended.
- Male adapters with plastic threads are to be used in cold water applications only.
- Only join to threaded components conforming to ANSI/ASME B1.20.1 or ASTM F 1498.
- Use Teflon tape. Teflon tape is recommended for all threaded connections and should be a .4 minimum density, .003" thick, .50% elongation and chemically inert. To apply start with two wraps at fitting end, wrap all threads

overlapping half the width of the tape in the direction of the threads on each wind.

- Avoid over-tightening as this may cause damage to the thread or the fitting.
- CPVC male and female adapter fittings with brass threads are recommended.
- When combining plastic and metal threaded systems, it is recommended that plastic male threads be screwed into metal female threads rather than metal male threads into plastic female threads.

Installation of Brass and CPVC Threaded Fittings			
Pipe Size	Torque Setting		Teflon Tape
	Brass Threaded Fittings	CPVC Threaded Fittings	
1/2"	14 ft.lbs.	3 to 5 ft.lbs.	1/2" width
3/4"	18 ft.lbs.	4 to 6 ft.lbs.	1/2" width
1"	24 ft.lbs.	5 to 7 ft.lbs.	1/2" width
1 1/4"	30 to 60 ft.lbs.	5 to 7 ft.lbs.	1" width
1 1/2"	23 to 34 ft.lbs.	6 to 8 ft.lbs.	1" width
2"	36 to 50 ft.lbs.	8 to 10 ft.lbs.	1" width

Note: 1 foot pound = 12 inch pounds

## Flame Spread and Smoke Rating for CPVC SDR 11 FlowGuard Gold

- CPVC piping systems are self extinguishing and will not support combustion. ASTM E 84 is the test protocol cited in the Uniform Mechanical Code and International Mechanical Code to determine a material's suitability for installation in a plenum area. This is essentially the same "Steiner Tunnel" test as NFPA no. 255, UL no. 723, and produces similar results. This is a full-scale burn test using 1/2" and 2" diameter pipe. The pipe was filled with water and capped on each end.
- Per ASTM E 84, CPVC in sizes 1/2" through 2", water filled, meets the 25/50 flame and smoke requirement for plenum application.
- CPVC piping systems comply with self extinguishing requirements of ASTM D 635.
- CPVC piping systems meet the V-0 burning class requirements of UL 94.
- Always follow prevailing code requirements.

# FLOWGUARD GOLD® COPPER TUBE SIZE (CTS) CPVC SDR 11 PIPE AND FITTINGS FACT SHEET

Plastics Technical Manual

## Mechanical Joints

- Brass ferrule compression ring
- See Lubrizol installation guide for further details.

## Thermal Expansion

- .408 inches per 10 degree temperature change per 100 foot of pipe

## Special Considerations

- Do **NOT** air test.
- Consult chemical resistant chart in our FlowGuard Gold® technical manual.
- U.V. sensitivity. Do not install permanently in direct sunlight without painting with water-based latex paint, or covering with pipe insulation.

## System

### FlowGuard Gold® (CTS) CPVC Pipe

#### Product Offering / Data

Size	Product	Available Lengths	Average OD	Nominal ID	Min. Wall	Weight Per 100 Ft. (lbs.)	Max Work PSI	
							73°F (23°C)	180°F (82°C)
1/2"	PE CTS Pipe	10' & 20'	0.625	0.485	0.068	8.5	400	100
3/4"			0.875	0.713	0.080	14.0	400	100
1"			1.125	0.921	0.102	21.8	400	100
1 1/4"			1.375	1.125	0.125	33.0	400	100
1 1/2"			1.625	1.329	0.148	46.0	400	100
2"			2.125	1.739	0.193	79.0	400	100
1/2"	Coiled PE	150'	0.625	0.485	0.068	8.5	400	100
3/4"	CTS Pipe	100'	0.875	0.713	0.080	14.0	400	100

## Temperature De-rating Factor

Temperature	De-Rating Factor	Pressure Rating
73°F	1.00	400 PSI
80°F	1.00	400 PSI
90°F	0.91	360 PSI
100°F	0.82	325 PSI
120°F	0.65	260 PSI
140°F	0.50	200 PSI
160°F	0.40	160 PSI
180°F	0.25	100 PSI

Principle: As the fluid temperature increases, the pipe's ability to hold pressure decreases.

Method: To find the pressure rating at a required temperature, multiply the cold water (73°F) pressure rating by the de-rating factor.

Example: Solve for 100°F.  
 $0.82 \times 400 \text{ PSI} = 328 \text{ PSI}$

## Minimum Cure Time to Test at 100 PSI

Size	60°F	40°F	32°F	0°F
1/2"	10 Min.	10 Min.	15 Min.	30 Min.
3/4"	10 Min.	15 Min.	15 Min.	30 Min.
1"	10 Min.	15 Min.	20 Min.	30 Min.
1 1/4"	10 Min.	15 Min.	20 Min.	30 Min.
1 1/2"	15 Min.	15 Min.	30 Min.	45 Min.
2"	15 Min.	15 Min.	30 Min.	60 Min.

- Cure times shown are sufficient to complete a test at 100 PSI with 60% humidity and cold water. Full cure may take significantly longer.
- Cure times are a function of air temperature, water temperature, humidity, and pipe size. Increase the cure time for more demanding conditions.

# CHEMDRAIN® CPVC CHEMICAL WASTE SYSTEM FACT SHEET

**CHARLOTTE**  
PIPE AND FOUNDRY COMPANY®

## System

- ChemDrain® CPVC Chemical Waste System

## Installation Instructions

- ChemDrain Technical and Installation Manual, latest edition

## Standards

- NSF-cw S.E.
- IAPMO IGC #210-05
- IAPMO R & T Listing File #4822
- ASTM F 441 Plain End Pipe
- ASTM D 3311 Fitting Patterns

## Dimensional Standard

- Schedule 40 Iron Pipe Size (IPS)

## Cell Class

- Pipe and Fittings 23447

## Maximum Working Temperature

- 210° F

## Maximum Working Pressure

- Not pressure rated

## Joining Method

- Solvent Weld Joints

Shall be joined with ChemDrain solvent cement conforming to ASTM F-493.

Primer is not required.

- Mechanical Joints

May be flanged with ChemDrain Sch. 80 flanges.

- Threaded Joints

MIP and FIP adapters are available. Only join to threaded components conforming to ANSI/ASME B1.20.1 or ASTM F 1498.

## Thermal Expansion

- Coefficient of linear expansion:  $3.4 \times 10^{-5}$
- 4" per 100' of pipe with a 100° F temperature rise.
- For relative humidity above 60%, allow 50% more cure time.

## Set and Cure Times

Temperature	Initial Set	Cure
60° - 100° F	30 min.	1 hr.
40° - 60° F	1 hr.	2 hrs.
0° - 40° F	2 hrs.	4 hrs.

## Special Considerations

- Do **NOT** air test.
- For chemical resistance, see ChemDrain Technical and Installation manual, latest edition.
- Teflon tape is the only recommended thread sealant. Teflon tape is recommended for all threaded connections and should be a .4 minimum density, .003" thick, .50% elongation and chemically inert. To apply start with two wraps at fitting end, wrap all threads overlapping half the width of the tape in the direction of the threads on each wind. Use of improper paste type pipe sealant may result in failure of pipe or fittings. Always verify with the manufacturer of the pipe sealant to confirm chemical compatibility with CPVC.
- ChemDrain is designed and listed to be installed as a system. ChemDrain pipe, fittings and solvent cement must be used for a complete system.

# CONVERSION CHARTS

## Temperature Conversion

Degrees Fahrenheit	Degrees Centigrade	Degrees Fahrenheit	Degrees Centigrade
-10	-23.3	90	32.2
-5	-20.6	95	35.0
0	-17.8	100	37.8
5	-15.0	110	43.3
10	-12.2	120	48.9
15	-9.4	130	54.4
20	-6.7	140	60.0
25	-3.9	150	65.6
32	0	160	71.1
35	1.7	170	76.7
40	4.4	180	82.2
45	7.2	190	87.8
50	10.0	200	93.3
55	12.8	212	100.0
60	15.6	220	104.4
65	18.3	230	110.0
70	21.1	240	115.6
75	23.9	250	121.1
80	26.7	260	126.7
85	29.4		

For temperatures not shown, the following formulas apply:  
 $^{\circ}\text{F to }^{\circ}\text{C} = 5/9 (^{\circ}\text{F}-32)$        $^{\circ}\text{C to }^{\circ}\text{F} = 9/5 ^{\circ}\text{C} + 32$

## Metric Conversion

Pipe Size (mm)	Pipe Size (in.)	Pipe Size (mm)	Pipe Size (in.)
6mm	1/8 in.	90mm	3 1/2 in.
7mm	3/16 in.	100mm	4 in.
8mm	1/4 in.	125mm	5 in.
10mm	3/8 in.	150mm	6 in.
15mm	1/2 in.	200mm	8 in.
18mm	5/8 in.	250mm	10 in.
20mm	3/4 in.	300mm	12 in.
25mm	1 in.	350mm	14 in.
32mm	1 1/4 in.	400mm	16 in.
40mm	1 1/2 in.	450mm	18 in.
50mm	2 in.	500mm	20 in.
65mm	2 1/2 in.	600mm	24 in.
80mm	3 in.		

To the best of our knowledge the information contained in this publication is accurate. However, Charlotte Pipe and Foundry does not assume any liability whatsoever for the accuracy or completeness of such information. Final determination of the suitability of any information or product for the use to be contemplated is the sole responsibility of the user. The manner of that use and whether there is any infringement of patents is also the sole responsibility of the user.

# CONVERSION CHARTS

## The Conversion of Fractions to Decimals

Fraction	Decimal	Fraction	Decimal
1/64	0.015625	33/64	0.515625
1/32	0.031250	17/32	0.53125
3/64	0.046875	35/64	0.546875
1/16	0.062500	9/16	0.5625
5/64	0.078125	37/64	0.578125
3/32	0.937500	19/32	0.59375
7/64	0.109375	38/64	0.609375
1/8	0.125000	5/8	0.625
9/64	0.140625	41/64	0.640625
5/32	0.156250	21/32	0.65625
11/64	0.171900	43/64	0.67187
3/16	0.187500	11/16	0.6875
13/64	0.203100	45/64	0.70312
7/32	0.218800	23/32	0.71875
15/64	0.234375	47/64	0.734375
1/4	0.250000	3/4	0.75
17/64	0.265625	49/64	0.765625
9/32	0.281250	25/32	0.78125
19/64	0.296875	51/64	0.79875
5/16	0.312500	13/16	0.8125
21/64	0.328125	53/64	0.82125
11/32	0.343750	27/32	0.84375
23/64	0.359375	55/64	0.859375
3/8	0.375000	7/8	0.875
25/64	0.398625	57/64	0.890625
13/32	0.406250	29/32	0.90625
27/64	0.421875	59/64	0.921875
7/16	0.437500	15/16	0.9375
29/64	0.453125	61/64	0.953125
15/32	0.468750	31/32	0.96875
31/64	0.484375	63/64	0.984375
1/2	0.500000	1"	1

# LIMITED WARRANTY

Charlotte Pipe and Foundry Company® (Charlotte Pipe®) Products are warranted to be free from manufacturing defects and to conform to currently applicable ASTM standards for a period of five years from date of delivery. Buyer's remedy for breach of this warranty is limited to replacement of, or credit for, the defective product. This warranty excludes any expense for removal or reinstallation of any defective product and any other incidental, consequential, or punitive damages. **This limited warranty is the only warranty made by seller and is expressly in lieu of all other warranties, express and implied, including any warranties of merchantability and fitness for a particular purpose.** No statement, conduct or description by Charlotte Pipe or its representative, in addition to or beyond this Limited Warranty, shall constitute a warranty. This Limited Warranty may only be modified in writing signed by an officer of Charlotte Pipe.

This Limited Warranty will not apply if:

- 1) The Products are used for purposes other than their intended purpose as defined by local plumbing and building codes, and the applicable ASTM standard.
- 2) The Products are not installed in good and workmanlike manner consistent with normal industry standards; installed in compliance with the latest instructions published by Charlotte Pipe and good plumbing practices; and installed in conformance with all local plumbing, fire and building code requirements.
- 3) The Products fail due to defects or deficiencies in design, engineering, or installation of the piping system of which they are a part.
- 4) The Products have been the subject of modification; misuse; misapplication; improper maintenance or repair; damage caused by the fault or negligence of anyone other than Charlotte Pipe; or any other act or event beyond the control of Charlotte Pipe.
- 5) The Products fail due to the freezing of water in the Products.
- 6) The Products fail due to contact with chemical agents, fire stopping materials, thread sealant, plasticized vinyl products, or other aggressive chemical agents that are not compatible.
- 7) Pipe outlets, sound attenuation systems or other devices are permanently attached to the surface of Charlotte PVC, ABS or CPVC products with solvent cement or adhesive glue.

Any product proved to be defective in manufacture will be replaced F.O.B. point of original delivery, or credit issued, at the discretion of Charlotte Pipe. **Purchaser must obtain written permission and/or a return goods authorization** and instructions for return shipment to Charlotte Pipe of any product claimed defective, shipped in error or excess of inventory needs.

All products alleged to be defective **must** be made available to Charlotte Pipe at the following address for verification, inspection and determination of cause:

Charlotte Pipe and Foundry Company  
Attention: Warranty Department  
P.O. Box 35430  
Charlotte, North Carolina 28235

**Warning:** Charlotte Pipe products are not to be used with compressed air or gases. Charlotte Pipe **does not recommend** that piping systems that include its products be tested with compressed air or gases.

05/30/08



# REFERENCE STANDARDS PLASTICS

ASTM	TITLE
D 635	STANDARD TEST METHOD FOR RATE OF BURNING AND/OR EXTENT AND TIME OF BURNING OF PLASTICS IN A HORIZONTAL POSITION
SCOPE:	THIS FIRE-TEST-RESPONSE TEST METHOD COVERS A SMALL-SCALE LABORATORY SCREENING PROCEDURE FOR COMPARING THE RELATIVE LINEAR RATE OF BURNING OR EXTENT AND TIME OF BURNING, OR BOTH, OF PLASTICS IN THE HORIZONTAL POSITION.
D 1784	SPECIFICATION FOR RIGID POLY (VINYL CHLORIDE) (PVC) COMPOUNDS AND CHLORINATED POLY (VINYL CHLORIDE) (CPVC) <b>COMPOUNDS</b>
SCOPE:	THIS SPECIFICATION COVERS RIGID PVC AND CPVC COMPOUNDS INTENDED FOR GENERAL PURPOSE USE IN EXTRUDED OR MOLDED FORM.
D 1785	SPECIFICATION FOR POLY (VINYL CHLORIDE) ( <b>PVC</b> ) PLASTIC <b>PIPE, SCHEDULE 40, 80, AND 120</b>
SCOPE:	THIS SPECIFICATION COVERS PVC PIPE IN SCHEDULE 40, 80, AND 120 FOR PRESSURE APPLICATIONS. THIS SYSTEM IS INTENDED FOR PRESSURE APPLICATIONS WHERE THE OPERATING TEMPERATURE WILL NOT EXCEED 140 DEGREE FAHRENHEIT.
D 2235	SPECIFICATION FOR SOLVENT <b>CEMENT FOR</b> ACRYLONITRILE-BUTADIENE-STYRENE ( <b>ABS</b> ) PLASTIC PIPE AND FITTINGS
SCOPE:	THIS SPECIFICATION COVERS SOLVENT CEMENT FOR JOINING (ABS) PIPE AND FITTINGS FOR NONPRESSURE SYSTEMS.
D 2241	SPECIFICATIONS FOR POLY (VINYL CHLORIDE) ( <b>PVC</b> ) <b>PIPE</b> PRESSURE-RATED ( <b>SDR-SERIES</b> )
SCOPE:	THIS SPECIFICATION COVERS (PVC) PIPE MADE IN STANDARD THERMOPLASTIC PIPE DIMENSION RATIOS (SDR SERIES) AND PRESSURE RATED FOR WATER.
D 2321	STANDARD PRACTICE FOR UNDERGROUND INSTALLATION OF <b>THERMOPLASTIC PIPE FOR SEWERS</b> AND OTHER <b>GRAVITY-FLOW APPLICATIONS</b> .
SCOPE:	THIS PRACTICE PROVIDES RECOMMENDATIONS FOR THE INSTALLATION OF BURIED THERMOPLASTIC PIPE USED IN SEWERS AND OTHER GRAVITY-FLOW APPLICATIONS (NON-PRESSURE APPLICATIONS).
D 2464 or D 2467	SPECIFICATIONS FOR <b>THREADED POLY (VINYL CHLORIDE)</b> (PVC) PLASTIC PIPE <b>FITTINGS, SCHEDULE 80</b>
SCOPE:	THIS SPECIFICATION COVERS (PVC) THREADED SCHEDULE 80 FITTINGS WHICH ARE USED WITH THE DISTRIBUTION OF PRESSURIZED LIQUIDS ONLY. THREADED SCHEDULE 80 FITTINGS ARE NOW COVERED BY ASTM F 437.
D 2466	SPECIFICATIONS FOR POLY (VINYL CHLORIDE) ( <b>PVC</b> ) PLASTIC PIPE <b>FITTINGS, SCHEDULE 40</b>
SCOPE:	THIS SPECIFICATION COVERS (PVC) SCHEDULE 40 FITTINGS USED FOR DISTRIBUTION OF PRESSURIZED LIQUIDS ONLY.
D 2467	SPECIFICATIONS FOR SOCKET POLY (VINYL CHLORIDE) ( <b>PVC</b> ) PLASTIC PIPE <b>FITTINGS, SCHEDULE 80</b>
SCOPE:	THIS SPECIFICATION COVERS SOCKET (PVC) SCHEDULE 80 FITTINGS WHICH ARE USED WITH THE DISTRIBUTION OF PRESSURIZED LIQUIDS ONLY.

# REFERENCE STANDARDS PLASTICS

ASTM	TITLE
D 2564	SPECIFICATIONS FOR SOLVENT <b>CEMENTS FOR</b> POLY (VINYL CHLORIDE) ( <b>PVC</b> ) PLASTIC PIPE AND FITTINGS
SCOPE:	THIS SPECIFICATION COVERS REQUIREMENTS FOR (PVC) SOLVENT CEMENTS TO BE USED IN JOINING (PVC) PIPING SYSTEMS.
D 2661	SPECIFICATIONS FOR ACRYLONITRILE-BUTADIENE-STYRENE ( <b>ABS</b> ) SCHEDULE 40 PLASTIC <b>DRAIN, WASTE, AND VENT PIPE AND FITTINGS</b>
SCOPE:	THIS SPECIFICATION COVERS FITTINGS AND SINGLE EXTRUDED (SOLID WALL) (ABS) PLASTIC DRAIN, WASTE, AND VENT PIPE MADE TO SCHEDULE 40 IRON PIPE SIZES.
D 2665	SPECIFICATIONS FOR POLY (VINYL CHLORIDE) ( <b>PVC</b> ) PLASTIC <b>DRAIN, WASTE, AND VENT PIPE AND FITTINGS</b>
SCOPE:	THIS SPECIFICATION COVERS REQUIREMENTS FOR (PVC) PLASTIC DRAIN, WASTE, AND VENT PIPE AND FITTINGS SUITABLE FOR THE DRAINAGE AND VENTING OF SEWAGE AND CERTAIN OTHER LIQUID WASTE.
D 2729	SPECIFICATIONS FOR POLY (VINYL CHLORIDE) ( <b>PVC</b> ) <b>SEWER PIPE AND FITTINGS</b> "SEWER AND DRAIN"
SCOPE:	THIS SPECIFICATION COVERS REQUIREMENTS FOR (PVC) SEWER PIPE AND FITTINGS. THE PIPE AND FITTINGS IN THIS SPECIFICATION ARE DESIGNED FOR SEWER AND DRAINAGE APPLICATIONS OUTSIDE THE BUILDING.
D 2846	SPECIFICATIONS FOR CHLORINATED POLY (VINYL CHLORIDE) ( <b>CPVC</b> ) PLASTIC <b>HOT AND COLD WATER DISTRIBUTION SYSTEM</b>
SCOPE:	THIS SPECIFICATION COVERS REQUIREMENTS FOR (CPVC) PLASTIC HOT AND COLD WATER DISTRIBUTION SYSTEM COMPONENTS MADE IN ONE STANDARD DIMENSION RATIO AND INTENDED FOR WATER SERVICE UP TO AND INCLUDING 180 DEGREE FAHRENHEIT.
D 2949	SPECIFICATIONS FOR <b>3.25-IN. OUTSIDE DIAMETER</b> POLY (VINYL CHLORIDE) ( <b>PVC</b> ) PLASTIC DRAIN, WASTE, AND VENT <b>PIPE AND FITTINGS</b>
SCOPE:	THE REQUIREMENTS OF THIS SPECIFICATION ARE INTENDED TO PROVIDE PIPE AND FITTINGS SUITABLE FOR DRAINAGE OF SEWAGE AND CERTAIN OTHER LIQUID WASTE.
D 3034	SPECIFICATIONS FOR TYPE PMS POLY (VINYL CHLORIDE) ( <b>PVC</b> ) <b>SEWER PIPE AND FITTINGS SDR 35</b>
D 3212	SPECIFICATIONS FOR <b>JOINTS</b> FOR DRAIN AND SEWER PLASTIC PIPES <b>USING FLEXIBLE ELASTOMERIC SEALS</b>
SCOPE:	THIS SPECIFICATION COVERS JOINTS FOR PLASTIC PIPE SYSTEMS THROUGH COMPRESSION OF AN ELASTOMERIC SEAL OR RING.
D 3311	SPECIFICATION FOR DRAIN, WASTE AND VENT (DWV) <b>PLASTIC FITTING PATTERNS</b>
SCOPE:	THIS SPECIFICATION PROVIDES STANDARD FITTING GEOMETRIES AND LAYING LENGTHS FOR PLASTIC FITTINGS INTENDED FOR USE IN DRAIN, WASTE, AND VENT APPLICATIONS.

# REFERENCE STANDARDS PLASTICS

ASTM	TITLE
D 3965	SPECIFICATIONS FOR RIGID ACRYLONITRILE-BUTADIENE-STYRENE ( <b>ABS</b> ) <b>MATERIAL FOR PIPE AND FITTINGS</b>
SCOPE:	THIS SPECIFICATION COVERS MATERIALS MADE FROM ONLY VIRGIN ABS POLYMERS AND BLENDS OF ABS POLYMERS SUITABLE FOR USE IN THE EXTRUSION OF PIPE AND MOLDED FITTINGS.
D 4396	SPECIFICATIONS FOR RIGID POLY (VINYL CHLORIDE) ( <b>PVC</b> ) AND RELATED PLASTIC <b>COMPOUNDS FOR NONPRESSURE PIPING PRODUCTS</b>
SCOPE:	THE REQUIREMENTS OF THIS SPECIFICATION ARE INTENDED FOR THE QUALITY CONTROL OF COMPOUNDS USED TO MANUFACTURE PIPE AND FITTINGS INTENDED FOR NONPRESSURE USE.
F 437	SPECIFICATION FOR <b>THREADED</b> CHLORINATED POLY (VINYL CHLORIDE) ( <b>CPVC</b> ) PLASTIC PIPE <b>FITTING, SCHEDULE 80</b>
SCOPE:	THIS SPECIFICATION COVERS CPVC THREADED SCHEDULE 80 FITTINGS, INTENDED FOR USE WITH IRON PIPE SIZE (IPS) OUTSIDE DIAMETER PLASTIC PIPE.
F 439	SPECIFICATION FOR CHLORINATED POLY (VINYL CHLORIDE) ( <b>CPVC</b> ) PLASTIC <b>PIPE FITTING, SCHEDULE 80</b>
SCOPE:	THIS SPECIFICATION COVERS SCHEDULE 80 CPVC FITTINGS, INTENDED FOR USE WITH IRON PIPE SIZE (IPS) OUTSIDE DIAMETER PLASTIC PIPE.
F 441	SPECIFICATIONS FOR CHLORINATED POLY (VINYL CHLORIDE) ( <b>CPVC</b> ) PLASTIC <b>PIPE, SCHEDULE 40</b>
SCOPE:	THIS SPECIFICATION COVERS CPVC PIPE MADE IN SCHEDULE 80 SIZES AND PRESSURE RATED FOR WATER.
F 477	SPECIFICATIONS FOR <b>ELASTOMERIC SEALS</b> (GASKETS) <b>FOR JOINING PLASTIC PIPE</b>
SCOPE:	THIS SPECIFICATION COVERS ELASTOMERIC SEALS (GASKETS) USED TO SEAL THE JOINT OF PLASTIC PIPE USED FOR GRAVITY APPLICATION.
F 480	SPECIFICATION FOR THERMOPLASTIC <b>WELL CASING</b> PIPE AND COUPLINGS MADE IN STANDARD DIMENSION RATIOS (SDR), SCHEDULE 40 AND SCHEDULE 80
SCOPE:	THIS SPECIFICATION COVERS WATER WELL CASING PIPE AND COUPLING MADE FROM THERMOPLASTIC MATERIAL IN STANDARD DIMENSION RATIOS (SDR), SCHEDULE 40 AND SCHEDULE 80.
F 493	SPECIFICATION FOR SOLVENT <b>CEMENTS</b> FOR CHLORINATED POLY (VINYL CHLORIDE) ( <b>CPVC</b> ) PLASTIC PIPE AND FITTINGS
SCOPE:	THIS SPECIFICATION PROVIDES REQUIREMENTS FOR CPVC SOLVENT CEMENT TO BE USED IN JOINING CPVC PIPE AND SOCKET TYPE FITTINGS.
F 628	SPECIFICATION FOR ACRYLONITRILE-BUTADIENE-STYRENE ( <b>ABS</b> ) SCHEDULE 40 PLASTIC DRAIN, WASTE, AND VENT PIPE WITH A <b>CELLULAR CORE</b>
SCOPE:	THIS SPECIFICATION COVERS COEXTRUDED ABS PLASTIC DRAIN, WASTE, AND VENT PIPE MADE TO SCHEDULE 40 IRON PIPE SIZE (IPS).

# REFERENCE STANDARDS PLASTICS

ASTM	TITLE
F 656	SPECIFICATION FOR <b>PRIMERS</b> FOR USE IN SOLVENT CEMENT JOINTS OF POLY (VINYL CHLORIDE) ( <b>PVC</b> ) PLASTIC PIPE AND FITTINGS
SCOPE:	THIS SPECIFICATION COVERS REQUIREMENTS FOR PRIMERS FOR USE WITH PVC PIPE AND FITTINGS THAT ARE TO BE JOINED BY PVC CEMENT MEETING THE REQUIREMENTS OF SPECIFICATION D 2564.
F 891	SPECIFICATION FOR <b>COEXTRUDED</b> POLY (VINYL CHLORIDE) ( <b>PVC</b> ) <b>PLASTIC PIPE WITH A CELLULAR CORE</b> NONPRESSURE IN THREE SERIES: <b>SCHEDULE 40, PS SERIES 25, 50, 100, AND A SEWER AND DRAIN</b> SERIES
SCOPE:	THIS SPECIFICATION COVERS COEXTRUDED PVC PLASTIC PIPE WITH A CELLULAR CORE FOR NONPRESSURE USE IN THREE SERIES: AN IPS SCHEDULE 40 SERIES; A PS SERIES WITH AN IRON PIPE SIZE OUTSIDE DIAMETER WITH VARYING WALL THICKNESS AS REQUIRED FOR PIPE STIFFNESS OF 25, 50 AND 100; AND A SEWER AND DRAIN SERIES.
F 1668	STANDARD GUIDE FOR CONSTRUCTION PROCEDURES FOR <b>BURIED PLASTIC PIPE</b>
SCOPE:	THIS GUIDE DESCRIBES INSTALLATION TECHNIQUES AND CONSIDERATIONS FOR OPEN-CUT CONSTRUCTION OF BURIED PIPE.

## NATIONAL SANITATION FOUNDATION

NSF / ANSI	TITLE
14	PLASTICS PIPING SYSTEM COMPONENTS AND RELATED MATERIALS
SCOPE:	THIS STANDARD ESTABLISHES MINIMUM PHYSICAL, PERFORMANCE, HEALTH EFFECTS, QUALITY ASSURANCE, MARKING AND RECORD-KEEPING REQUIREMENTS FOR PLASTIC PIPING COMPONENTS AND RELATED MATERIALS. THE ESTABLISHED PHYSICAL, PERFORMANCE AND HEALTH EFFECTS REQUIREMENTS APPLY TO MATERIALS (RESIN OR BLENDED COMPOUNDS) AND INGREDIENTS USED TO MANUFACTURE PLASTIC PIPING SYSTEM COMPONENTS.
61	DRINKING WATER SYSTEM COMPONENTS - HEALTH EFFECTS
SCOPE:	THIS STANDARD COVERS SPECIFIC MATERIALS OR PRODUCTS THAT COME INTO CONTACT WITH DRINKING WATER, DRINKING WATER TREATMENT CHEMICALS OR BOTH. THE FOCUS OF THE STANDARD IS EVALUATION OF CONTAMINANTS OR IMPURITIES IMPARTED INDIRECTLY TO DRINKING WATER.

## UNDERWRITERS LABORATORIES

UL	TITLE
UL 94	FLAMMABILITY TESTING
SCOPE:	THIS TEST INDICATES THAT THE MATERIAL WAS TESTED IN A VERTICAL POSITION AND SELF-EXTINGUISHED WITHIN A SPECIFIED TIME AFTER THE IGNITION SOURCE WAS REMOVED.





## NOTES

# CHARLOTTE

**PIPE AND FOUNDRY COMPANY®**

PO BOX 35430

CHARLOTTE

NORTH CAROLINA 28235

PHONE (704) 348-6450

(800) 438-6091

FAX (800) 553-1605

LITERATURE BY FAX (800) 745-9382

[WWW.CHARLOTTEPIPE.COM](http://WWW.CHARLOTTEPIPE.COM)

