

Water Heater Connectors

NEW

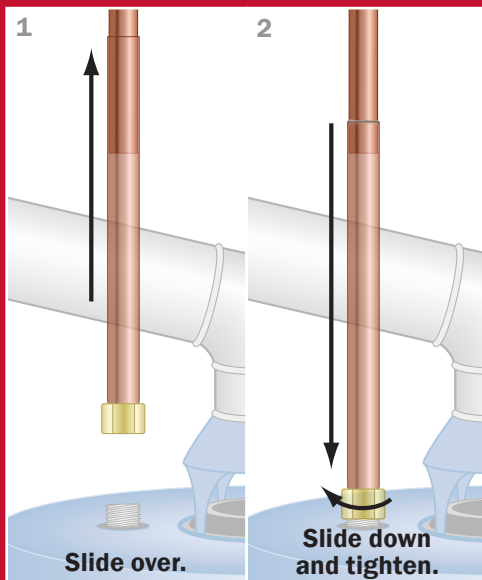

FULL-SLIP



- **FASTER**

Pre-fabricated water heater connectors are perfect for new construction and repair/replacement installations

- **EASIER**

Buy water heater connectors in bulk or in kits. Sioux Chief offers cold, hot and expansion tank connection options

- **SUPERIOR**

Build your own custom kit to fit your exact project requirements

Kits available for tankless water heaters and heating coil loop



Supply • Drainage • Support • Testing • Specialties • Tools • Access

**Sioux
Chief** 
MANUFACTURING SINCE 1957

Sioux Chief Water Heater Connectors

Sioux Chief Water Heater Connectors allow for fast and easy water heater installations for copper, PEX or CPVC piping systems. Contractors no longer need to pre-fab water heater connectors in the shop or field. Be sure to follow all local plumbing codes for water heater installation.



Copper System

Full-slip female sweat, full-slip compression



PEX System

PEX F1807, PEX F1960,
Viega PEX Press, PEX F2080



CPVC System

CPVC socket

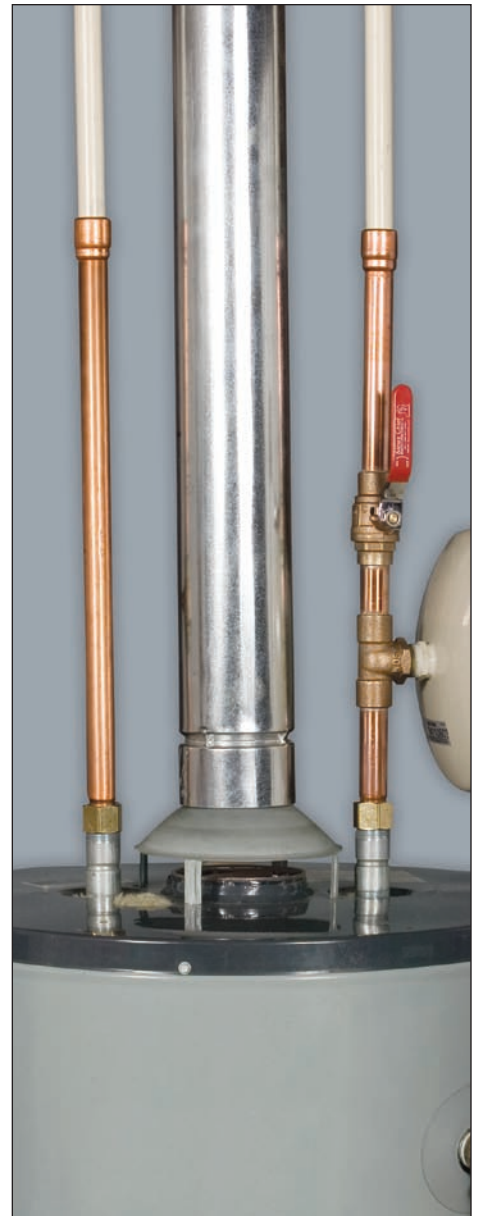
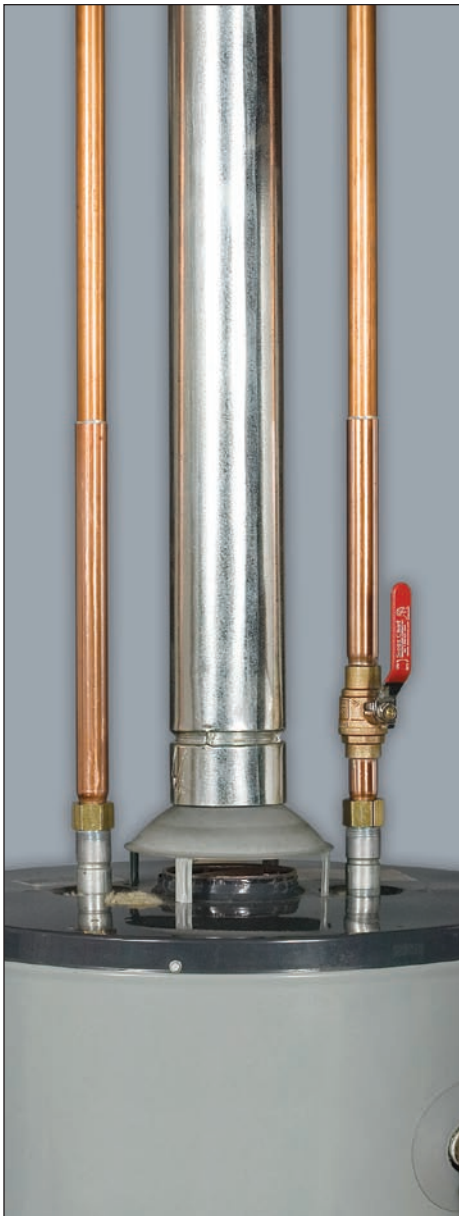

Features

- **Adjustable to different heights** New heaters are never the same height as the old ones. Full-slip copper allows you to slide the connector onto the remaining copper supply, and then back down to the new height.
- **No need for exact measurements** Several inches of full-slip copper allows you to cut the copper to the *approximate* length. Even if you are too long on your cut, the full-slip allows you to slide the joint wherever it needs to be.
- **Valve is already installed in connector** Soldering copper to copper is hard enough, but soldering to a valve is the toughest. It takes more heat than a normal solder joint, but too much heat will melt the seats and ruin the valve. Having

the valve already soldered into the connector is more than just a time saver; it's a *valve saver*.

- **Holds everything in place for soldering** Connect the swivel nut to the heater nipple and fully tighten for a proper seal, prior to soldering to the copper tube. Everything will be in place for proper soldering. No more trying to hold loose copper elbows and tees together while soldering. The connector acts like a built-in soldering jig to hold everything.
- **Professional Look** Sioux Chief has THE ONLY preformed connector on the market that is solid copper. When finished, the plumber has a professional, straight, sturdy installation.

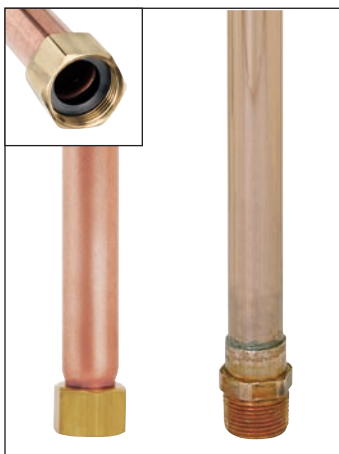

FIP & MIP

Sioux Chief water heater connectors are available with ¾" and 1" MIP or FIP swivel connection. Each FIP swivel connection contains a thick rubber gasket for a tight seal and serves as a dielectric union.

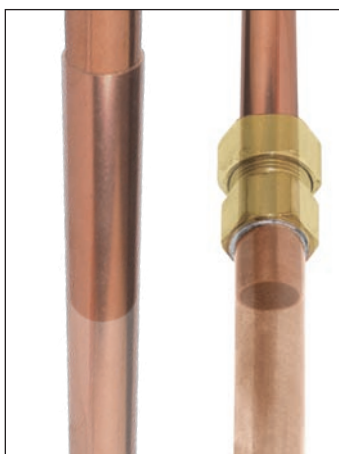

Full-Slip Sweat & Compression

For copper systems, ½" or ¾" full-slip sweat or ⅞" O.D. compression connections are available.



Flex, Hard & Elbow

Sioux Chief offers flexible corrugated connectors and ¾" type-L in both straight and elbow water heater connectors for easy water heater installations.



Lengths

All connectors are available in a variety of lengths to meet CPVC and PEX manufacturer installation instructions, IPC and UPC model codes guidelines for electric and gas water heater installations.

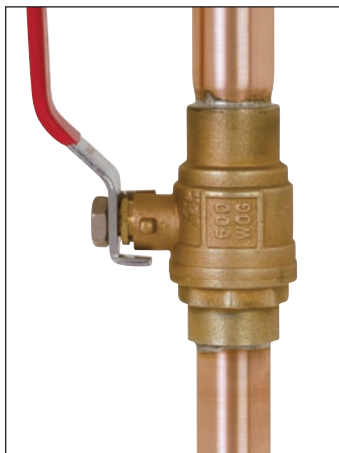

600 WOG

Cold side connectors have 600 WOG full port ball valve.



Expansion Tank

Water heater connectors with a ¾" FIP branch for a two gallon expansion tank are available. in a top mount or side mount application.



Tankless

Tankless water heater connectors available with ¾" sweat and FIP connections.

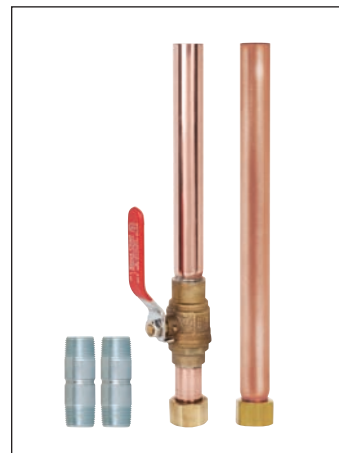

Kits or Bulk

Water heater connectors can be packaged in both bundled kits or in bulk.

Kits

- Convenient kits are great for new construction and repair/remodel job sites.
- Build your own pre-packaged water heater connector kit with the number system below.
- Kits are individually bagged and shipped 10 to a box.

Most Popular Kits

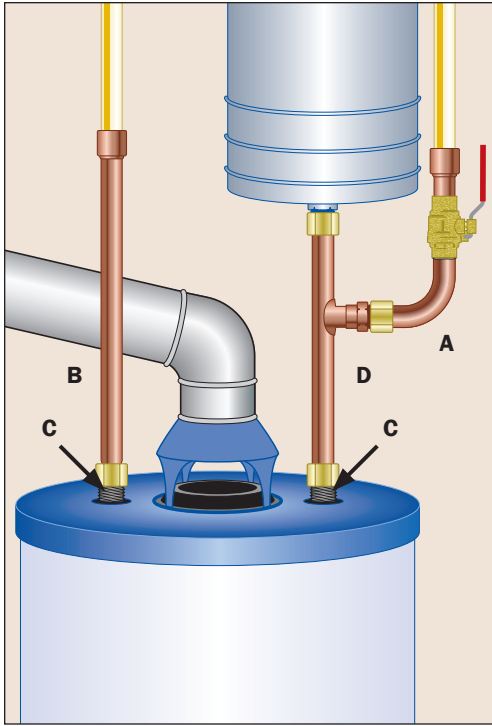

- A** Cold Side Connector
- B** Hot Side Connector
- C** Dielectric Nipple Option
- D** Expansion Tank Option

Item No.	Components	Pkg	Min. Qty	Case Qty
SWEAT				
694-211123	3/4" FIP swivel x 3/4" full-slip FSWT 3/4" FIP swivel x 3/4" full-slip FSWT, ball valve Two 3/4" MIP x 3/4" MIP dielectric nipples	B	10	10
694-211120	3/4" FIP swivel x 3/4" full-slip FSWT 3/4" FIP swivel x 3/4" full-slip FSWT, ball valve	B	10	10
PEX				
694X32012091	3/4" FIP swivel x 3/4" PEX barb 3/4" FIP swivel x 3/4" PEX barb elbow, with ball valve 3/4" x 3/4" FIP swivel with 3/4" MIP branch	B	10	10
694X32012391	3/4" FIP swivel x 3/4" PEX barb 3/4" FIP swivel x 3/4" PEX barb elbow, with ball valve Two 3/4" MIP x 3/4" MIP dielectric nipples 3/4" x 3/4" FIP swivel with 3/4" MIP branch	B	10	10
694X322123	3/4" FIP swivel x 3/4" PEX barb 3/4" FIP swivel x 3/4" PEX barb, with ball valve Two 3/4" MIP x 3/4" MIP dielectric nipples	B	10	10
CPVC				
694C33012091	3/4" FIP swivel x 3/4" CPVC socket 3/4" FIP swivel x 3/4" CPVC socket elbow, ball valve 3/4" x 3/4" FIP swivel with 3/4" MIP branch	B	10	10
694C331220	3/4" FIP swivel x 3/4" CPVC socket 3/4" FIP swivel x 3/4" CPVC socket, ball valve	B	10	10
694C33012093	3/4" FIP swivel x 3/4" CPVC socket 3/4" FIP swivel x 3/4" CPVC socket elbow, ball valve 3/4" x 3/4" FIP swivel with 3/4" MIP branch	B	10	10
694C361520	1" FIP swivel x 3/4" CPVC socket 1" FIP swivel x 3/4" CPVC socket, ball valve	B	10	10
694C36012092	1" FIP swivel x 3/4" CPVC socket 3/4" FIP swivel x 3/4" CPVC socket elbow, ball valve 1" x 3/4" FIP swivel with 3/4" MIP branch	B	10	10
694C36012094	1" FIP swivel x 3/4" CPVC socket 3/4" FIP swivel x 3/4" CPVC socket elbow, ball valve 1" x 3/4" FIP swivel with 3/4" MIP branch	B	10	10
694C33012391	3/4" FIP swivel x 3/4" CPVC socket 3/4" FIP swivel x 3/4" CPVC socket elbow, ball valve Two 3/4" MIP x 3/4" MIP dielectric nipples 3/4" x 3/4" FIP swivel with 3/4" MIP branch	B	10	10

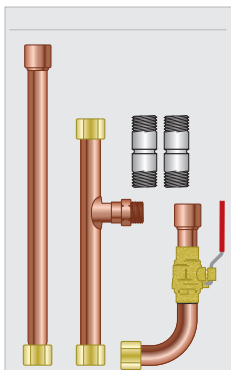

Build Kit Item Numbers

Component	Supply System	A Hot Side Connector	B Cold Side Connector	C Nipple Option	D Expansion Tank Option	Packaging Fee	Water Heater Connector Kit 694-A B C D
Kit Code	694-	21	01	23	91	\$1.50	694-21 01 23 91
Description	copper	straight 3/4" MIP swivel x 3/4" full-slip FSWT	elbow 3/4" FIP swivel x 3/4" FSWT, ball valve	two 3/4" MIP x 3/4" MIP	3/4" FIP swivel x 3/4" FIP swivel with 3/4" MIP branch		Completed Kit Item Number

Packaging Codes || B: bulk

Copper

694- + A + B + C + D

DO NOT use pipe dope or Teflon tape on FIP threads.

Swivel → Fitting → FIP connector nuts swivel

A Hot Side Connector

Item No.	Kit Code	Description	Length
633-312	21	¾" FIP swivel × ¾" full-slip FSWT	12"
633-4312	22	1" FIP swivel × ¾" full-slip FSWT	12"
633-312C	23	¾" FIP swivel × ⅞" compression	12"
631-33F	41	¾" FIP swivel × ¾" FSWT elbow	3" × 3"
633-212	81	¾" FIP swivel × ½" full-slip FSWT	12"

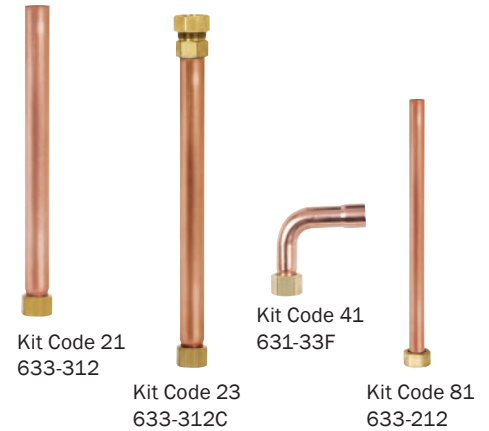

B Cold Side Connector

Item No.	Kit Code	Description	Length
631-305FP	01	¾" FIP swivel × ¾" FSWT elbow, ball valve	3" × 5"
633-312FP	11	¾" FIP swivel × ¾" full-slip FSWT, ball valve	12"
633-4312FP	12	1" FIP swivel × ¾" full-slip FSWT, ball valve	12"
633-312CFP	13	¾" FIP swivel × ⅞" compression, ball valve	12"
633-212FP	82	¾" FIP swivel × ½" full-slip FSWT, ball valve	12"
633-318FPT	31	¾" FIP swivel × ¾" full-slip FSWT, ball valve with ¾" FIP branch	18"

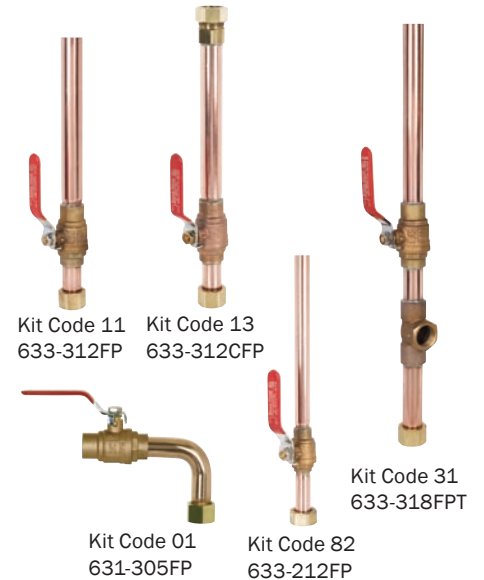

C Nipple Option

Item No.	Kit Code	Description	Length
—	20	No nipples	—
635-33	23	Two ¾" MIP × ¾" MIP	3"
635-43	24	Two 1" MIP × 1" MIP	3"



D Expansion Tank Option

Item No.	Kit Code	Description	Length
—	—	No expansion tank	—
633-3TM15	91	¾" × ¾" FIP swivel with ¾" MIP branch	15"
633-4TM15	92	1" × ¾" FIP swivel with ¾" MIP branch	15"
633-3TM11	93	¾" × ¾" FIP swivel with ¾" MIP branch	11"
633-4TM11	94	1" × ¾" FIP swivel with ¾" MIP branch	11"

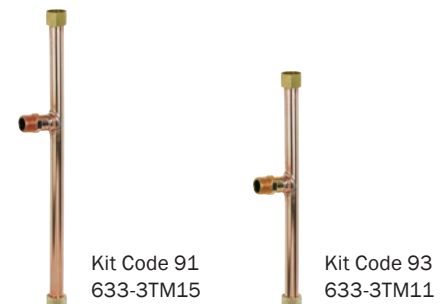

DO NOT use pipe dope or Teflon tape on FIP threads.

Swivel →
← Fitting FIP connector nuts swivel

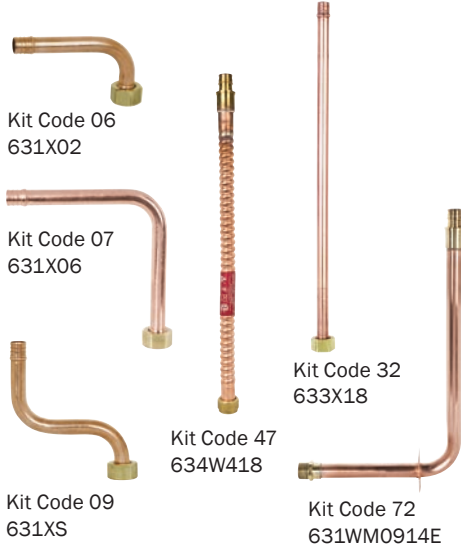

PEX

694X + A + B + C + D

A Hot Side Connection

Item No.	Kit Code	Connection	Length
631X02	06	3/4" PEX × 3/4" FIP swivel elbow	2 1/2" × 4 1/2"
631X06	07	3/4" PEX × 3/4" FIP swivel elbow	6" × 6"
631XM	08	3/4" PEX × 3/4" MIP, elbow	4" × 6"
631XS	09	3/4" PEX × 3/4" FIP swivel s-bend	6" × 4 1/2"
633X02	31	3/4" PEX × 3/4" FIP swivel	2"
633X18	32	3/4" PEX × 3/4" FIP swivel	18"
633X418	36	3/4" PEX × 1" FIP swivel	18"
634X418	46	3/4" PEX × 3/4" FIP swivel flexible	18"
646X3	61	3/4" PEX × 3/4" MIP	—
646X318	62	3/4" PEX × 3/4" MIP	18"
NEW 634V418	48	3/4" FIP × Viega PEX Press flexible	18"
NEW 634W418	47	3/4" FIP × F1960 flexible	18"
631WM0914E	72	3/4" F1960 × 3/4" MIP elbow with Square O	14" × 9"
631XM0914E	71	3/4" PEX × 3/4" MIP elbow with Square O	14" × 9"

B Cold Side Connection

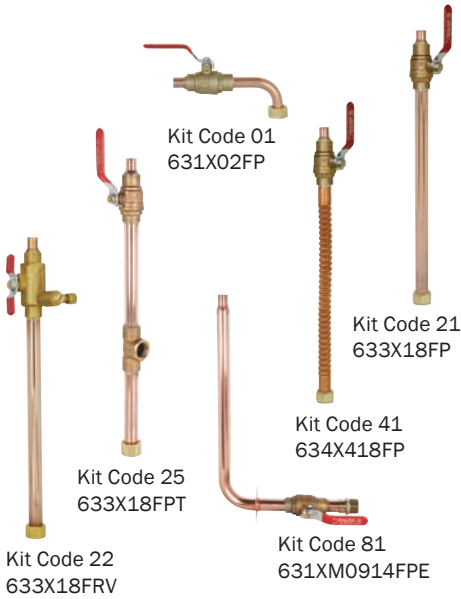

Item No.	Kit Code	Connection	Length
631X02FP	01	3/4" PEX × 3/4" FIP swivel elbow, ball valve	2 1/2" × 6"
633X18FP	21	3/4" PEX × 3/4" FIP swivel, ball valve	18"
633X18FPT	25	3/4" PEX × 3/4" FIP swivel, ball valve with 3/4" FIP branch for expansion tank	18"
634X418FP	41	3/4" PEX × 3/4" FIP swivel flexible, ball valve	18"
646X318FP	51	3/4" PEX × 3/4" MIP, ball valve	18"
633X418FP	71	3/4" PEX × 1" FIP swivel, ball valve	18"
633X18FRV	22	3/4" PEX × 3/4" FIP swivel, ball valve with pressure relief 3/8" O.D. compression	18"
NEW 634V418FP	43	3/4" FIP × Viega PEX Press flexible, ball valve	18"
NEW 634W418FP	42	3/4" FIP × F1960 flexible, ball valve	18"
631WM0914FPE	84	3/4" F1960 × 3/4" MIP elbow with Square O	14" × 9"
631WM0914RFE	83	3/4" F1960 × 3/4" MIP elbow with Square O	14" × 9"
631XM0914FPE	81	3/4" PEX × 3/4" MIP elbow with Square O	14" × 9"

C Nipple Option



Item No.	Kit Code	Description	Length
—	20	No nipples	—
635-33	23	Two 3/4" MIP × 3/4" MIP	3"
635-43	24	Two 1" MIP × 1" MIP	3"

D Expansion Tank Option



Item No.	Kit Code	Description	Length
—	—	No expansion tank	—
633-3TM15	91	3/4" × 3/4" FIP swivel with 3/4" MIP branch	15"
633-4TM15	92	1" × 3/4" FIP swivel with 3/4" MIP branch	15"
633-3TM11	93	3/4" × 3/4" FIP swivel with 3/4" MIP branch	11"
633-4TM11	94	1" × 3/4" FIP swivel with 3/4" MIP branch	11"

CPVC

694C + A + B + C + D

DO NOT use pipe dope or Teflon tape on FIP threads.

Swivel →
← Fitting FIP connector nuts swivel

A Hot Side Connector

Item No.	Kit Code	Connection	Length
631-C307	06	3/4" FIP swivel × 3/4" CPVC socket elbow	3" × 7"
633-C02	31	3/4" FIP swivel × 3/4" CPVC socket	3"
633-C09	32	3/4" FIP swivel × 3/4" CPVC socket	9"
633-C18	33	3/4" FIP swivel × 3/4" CPVC socket	18"
633-C18M3	34	3/4" FIP swivel × 3/4" CPVC socket, with 3/4" MIP branch	18"
633-C24	35	3/4" FIP swivel × 3/4" CPVC socket	24"
633-C418	36	1" FIP swivel × 3/4" CPVC socket	18"
633-C424	37	1" FIP swivel × 3/4" CPVC socket	24"
634-C118	56	3/4" FIP swivel × 3/4" CPVC socket flexible	18"
646-C3	71	3/4" MIP × 3/4" CPVC socket	3 1/4"
646-C318	72	3/4" MIP × 3/4" CPVC socket	18"
646-C324	73	3/4" MIP × 3/4" CPVC socket	24"
646-C3418	74	1" MIP × 3/4" CPVC socket	18"
646-C3424	75	1" MIP × 3/4" CPVC socket	24"



B Cold Side Connector

Item No.	Kit Code	Connection	Length
631-C307FP	01	3/4" FIP swivel × 3/4" CPVC socket elbow, ball valve	3" × 7"
633-C09FP	11	3/4" FIP swivel × 3/4" CPVC socket, ball valve	9"
633-C18FP	12	3/4" FIP swivel × 3/4" CPVC socket, ball valve	18"
633-C18FPM3	13	3/4" FIP swivel × 3/4" CPVC socket, ball valve, with 3/4" MIP branch	18"
633-C24FP	14	3/4" FIP swivel × 3/4" CPVC socket, ball valve	24"
633-C418FP	15	1" FIP swivel × 3/4" CPVC socket, ball valve	18"
633-C424FP	16	1" FIP swivel × 3/4" CPVC socket, ball valve	24"
633-C18FRV	17	3/4" FIP swivel × 3/4" CPVC socket, ball valve with pressure relief 3/8" O.D. compression	18"
633-C18FPT	21	3/4" FIP swivel × 3/4" CPVC socket, ball valve, with 3/4" FIP branch	18"
633-C418FRV	25	1" FIP swivel × 3/4" CPVC socket, ball valve with pressure relief 3/8" O.D. compression	18"
634-C118FP	51	3/4" FIP swivel × 3/4" CPVC socket flexible, ball valve	18"
646-C318FP	61	3/4" MIP × 3/4" CPVC socket, ball valve	18"
646-C324FP	63	3/4" MIP × 3/4" CPVC socket, ball valve	24"
646-C3418FP	64	1" MIP × 3/4" CPVC socket, ball valve	18"
646-C3424FP	65	1" MIP × 3/4" CPVC socket, ball valve	24"
646-C318FPT	81	3/4" MIP × 3/4" CPVC socket, ball valve, with 3/4" FIP branch	18"

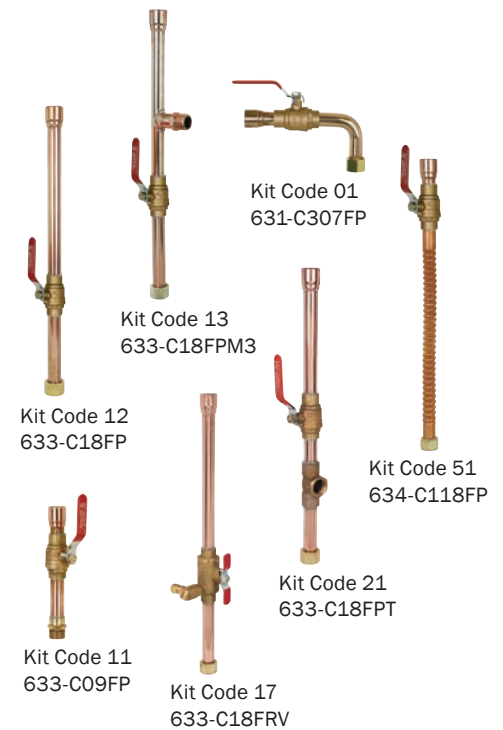

C Nipple Option

Item No.	Kit Code	Description	Length
—	20	No nipples	—
635-33	23	Two 3/4" MIP × 3/4" MIP	3"
635-43	24	Two 1" MIP × 1" MIP	3"



D Expansion Tank Option

Item No.	Kit Code	Description	Length
—	—	No expansion tank	—
633-3TM15	91	3/4" × 3/4" FIP swivel with 3/4" MIP branch	15"
633-4TM15	92	1" × 3/4" FIP swivel with 3/4" MIP branch	15"
633-3TM11	93	3/4" × 3/4" FIP swivel with 3/4" MIP branch	11"
633-4TM11	94	1" × 3/4" FIP swivel with 3/4" MIP branch	11"

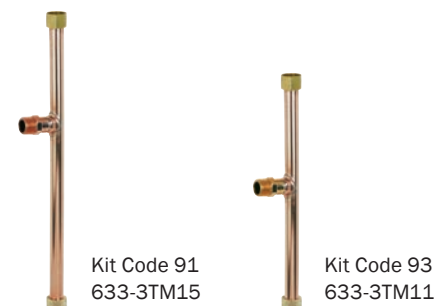

DO NOT use pipe dope or Teflon tape on FIP threads.



Tankless Water Heater Connector Kit

Sweat & FIP Connections

- Fits most tankless water heaters.
- ¾" full port ball valves.
- Integrated all brass tee for pressure valve.
- ¼-turn drain valves for drainage/flushing.
- Pressure valve and installation instructions included.
- Max heater input: 500,000 BTU/HR per ASME
- Max pressure: 150 PSI



Item No.	Connection	Pkg Qty	Min. Qty	Case Qty
690-0101	¾" FIP swivel × ¾" sweat	B*	1	1
690-2020	¾" FIP swivel × ¾" FIP	B*	1	1

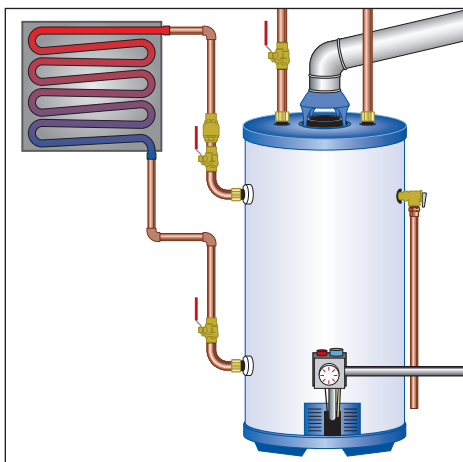

Heating Coil Loop Kit

Supply and Return Loop Connectors

- For use with high recovery hydronic systems. Preformed supply and return loop connectors provide easy installation

DO NOT use pipe dope on FIP threads



636-31308FK



636-C1307F2

Sweat System

Component	Supply Loop Elbow	Return Loop Elbow	Dielectric Connector
Standard Kit	¾" FIP swivel × ¾" FSWT, full port ball valve	¾" FIP swivel × ¾" FSWT, full port ball valve	Two ¾" MIP × ¾" MIP, 3" long
Check Valve Kit	¾" FIP swivel × ¾" FSWT, full port ball valve, with spring-loaded check valve	¾" FIP swivel × ¾" FSWT, full port ball valve	Two ¾" MIP × ¾" MIP, 3" long

CPVC System

Component	Supply Loop Elbow	Return Loop Elbow	Dielectric Connector	Boiler Drain	MIP Adapter
Standard Kit	¾" FIP swivel × ¾" CPVC, full port ball valve	¾" FIP swivel × ¾" CPVC, full port ball valve	Two ¾" MIP × ¾" MIP, 3" long	½" CPVC boiler drain	½" CPVC × ½" MIP adapter
Check Valve Kit	¾" FIP swivel × ¾" CPVC, full port ball valve, with spring-loaded check valve	¾" FIP swivel × ¾" CPVC, full port ball valve	Two ¾" MIP × ¾" MIP, 3" long	½" CPVC boiler drain	½" CPVC × ½" MIP adapter

Item No.	Description	Pkg	Min. Qty	Case Qty
SWEAT				
636-31305F	Standard heating coil loop kit	B	10	10
636-31308FK	Check valve heating coil loop kit	B	10	10
CPVC				
636-C1307F2	Standard heating coil loop kit	B	10	10
636-C1310FK2	Check valve heating coil loop kit	B	10	10

Packaging Codes || B: bulk *: individually bar-coded

DISTRIBUTED BY

24110 South Peculiar Drive
Peculiar, Missouri 64078
tel: 1-800-821-3944
fax: 1-800-758-5950
www.siouxchief.com

