

Features

- Recess or surface mount
- Ideal for remodeling: features 1" (2.5 cm) flange to hide gaps, paint lines or any wall imperfections
- Slow-close functionality
- 108-degree in-set adjustable hinge
- Clean interior due to "hidden" shelf adjustments and off-set door hinge (patent pending)
- 3 Mirror construction: front of door, back of door and inside of cabinet
- Low-profile laminated door design
- Thin door and off-set hinge allow for more storage than any cabinet of similar size
- Anodized aluminum construction
- Can be installed as a left- or right-hand door swing
- Three adjustable, cantilever glass shelves
- 16" (40.6 cm) W x 26" (66 cm) H x 4-3/4" (12.1 cm) D

RC1626D4FB1 ALSO RC1626D4FP1

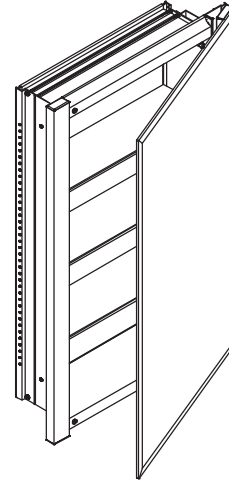

Codes/Standards Applicable

Specified model meets or exceeds the following:

- None applicable

Specified Model

Model	Description	
RC1626D4FB1	Beveled edge	<input type="checkbox"/>
RC1626D4FP1	Plain edge	<input type="checkbox"/>
Required Accessories - For Surface Mount Installations Only		
RSMK26D4P	Plain mirror side kit with mounting hardware	<input type="checkbox"/>

R³™ SERIES FLAT DOOR CABINET

Technical Information

Roughing-in opening	14" (35.6 cm) W x 24" (61 cm) H x 4" (10.2 cm) D
Door opening angle	108°

Installation Notes

Install this product according to the installation guide.

When determining the height of the mirrored cabinet, ensure the mirrored door will clear all obstacles, such as a faucet. A minimum distance of 1" (2.5 cm) is required.

Secure the screws (provided) to a stud to avoid possible property and product damage. If this is not possible, anchors (provided) must be inserted before installing the screws.

Recessed cabinets project 1" (2.5 cm) from wall.

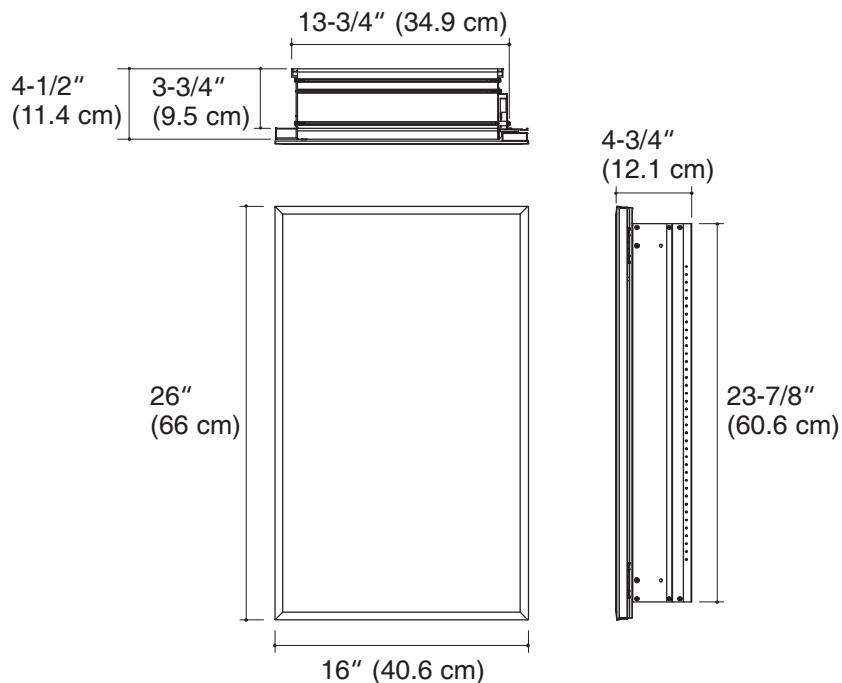

Product Diagram