

STINK STOPPER

QUAD CLOSE TRAP SEAL DEVICE



- IAPMO Listed: File No. 7479*.
- ASSE Listed: Standard 1072—Record No. 1435*.

The Answer to Infrequently Used Floor Drains and Sewer Gas Odors

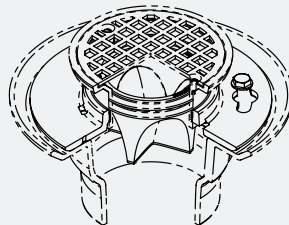

A Tested and Reliable Solution –

- IAPMO Listed: File No. 7479*.
- ASSE Listed: Standard 1072—Record No. 1435*.

Easy to Install –

In the floor drain, not the plumbing system.

A Value for the Purchaser –

Saves water and is easier to maintain than a trap primer.

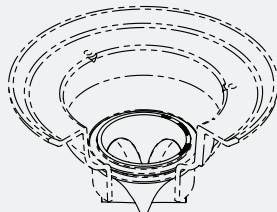

The Quad Close Trap Seal Device is for use in the floor drain outlet or the throat of an adjustable strainer to:

1. Minimize the evaporation of the trap seal in the floor drain,
2. Prevent the emission of sewer gases, and
3. Diminish the backup of raw sewage into a building.



JAY R. SMITH MFG. CO.
MEMBER OF MORRIS GROUP INTERNATIONAL

CUSTOMER
DRIVEN
SINCE 1926

Patent No. 8,844,572

STINK STOPPER

QUAD CLOSE TRAP SEAL DEVICE



Quad Close Trap Seal Device

Specify and Use Figure Number 2692

The Quad Close Trap Seal Device creates a watertight seal inside the drain and/or throat of the strainer. It will stay open when water is flowing into the floor drain. It will close when the water stops flowing. When closed, the Quad Close prevents the emission of sewer gases, minimizes the evaporation of water in the trap, and helps prevent backup into a building.

The Quad Close is made of a chemically resistant elastomer that is durable and reliable. The elastomeric material in the Quad Close is 2 to 4 times thicker than similar products. It is less vulnerable to UV, chemicals, cuts and tears.

Quad Close Trap Seal Device Advantages:



- Protects floor drain trap seals in infrequently used areas.
- IAPMO Listed: File No. 7479*.
- ASSE Listed: Standard 1072—Record No. 1435*.
- Reduces the need for the periodic admission of water into the floor drain's trap to maintain a seal.
- Provides easy removal for inspection and cleaning.
- Prevents the emission of sewer gases into a living or work area.
- Minimizes and/or prevents the evaporation of the trap seal water through the drain.
- Holds up to 10.00" of back pressure and can help prevent back flow.
- Closes completely with a very small amount of back pressure.
- Complements floor drains that have been specified with a trap primer connection.
- Resists damage from UV, chemicals, cuts and tears.
- Fits inside 1-1/2", 2"*, 3"*, 4"*, and 6" PVC and cast iron pipe.
The 3-1/2"* size is designed to fit inside the throat of the adjustable strainer on a shower drain.
- Works in new or existing drains.

Quad Close Trap Seal Device Installation Instructions

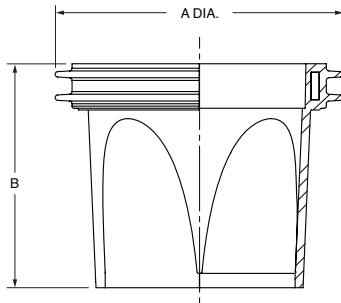
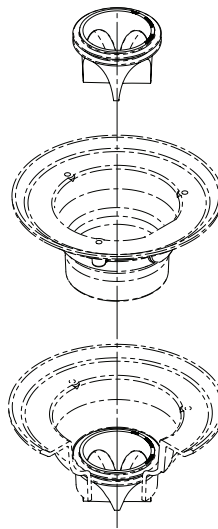
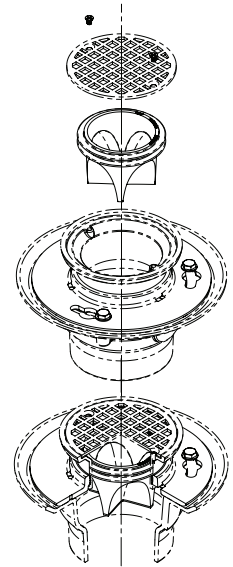

FIG. NO.	A (Pipe Size)	B	IAPMO LISTED	ASSE LISTED	GPM FLOW RATE
2692-0150	01.5(38)	2.09(53)	—	—	6.0 (22.7 L/M)
2692-02	02(50)	2.66(68)	FILE # 7479	REC.#1435 AF-GW	12.0 (45.4 L/M)
2692-03	03(75)	2.66(68)	FILE # 7479	REC.#1435 AF-GW	34.0 (128.7 L/M)
2692-0350	0350(89)	2.66(68)	FILE # 7479	REC.#1435 AF-GW	51.0 (193.06 L/M)
2692-04	04(100)	2.66(68)	FILE # 7479	REC.#1435 AF-GW	73.0 (276.4 L/M)
2692-06	06(150)	3.66(93)	—	—	215.0 (814.0 L/M)

NOTE: Dimensions shown in parentheses are in millimeters.



Installation in Drain Body Outlet
0150(38), 02(50), 03(75), 04(100) &
06(150) Sizes



Installation in Strainer
Throat
0350(89) Size

INSTALLATION: The 0150(38), 02(50), 03(75), 04(100) & 06(150) Quad Close Trap Seal sizes install in the drain outlet. The 0350(89) Quad Close Trap Seal size installs in the throat of adjustable strainers. To install simply insert the Quad Close Trap Seal in the drain outlet or throat of strainer until the top of it is flush with top of drain outlet or strainer throat.

Categories

Quad Close Trap Seal Device Overview—Fig. # 2692

Function:

The purpose of the Quad Close device is to minimize the evaporation of the trap seal for the floor drain. It will open to allow the flow of drainage and close when there is no flow. The trap seal is for use in the floor drain outlet or the throat of adjustable strainers.

Performance:

The Quad Close Trap Seal has been tested for thousands of hours with extraordinarily minimal loss of water due to evaporation.

Material:

The Quad Close Trap Seal Device is made from a chemically resistant elastomer.

Features and Sizes:





Designed to handle a wide range of pipe and internal drain body diameters. It can be retrofitted into existing drains. Available in 1-1/2", 2", 3", 3-1/2", 4", and 6" sizes.

To install, simply insert the device in the drain outlet until the top of the device is flush with the top of the drain outlet inside the pipe or strainer throat.

Benefits:

If sewer gases are escaping into the room due to the lack of water to maintain a water seal in the floor drain trap, this device can easily be inserted into the drain to prevent evaporation of trap seal water and to prevent sewer gases from escaping into the room. It will help lessen backflow.

Frequently Asked Questions

<p>1. Will gas pass through the cut in the Quad Close Trap Seal Device?</p> 	<p>Most sewer gas is heavier than air, thus a small amount (so small it is immeasurable) of back-pressure will <u>close the Quad Close</u>, causing the sewer gas to remain in the trap. The Quad Close Trap Seal Device is fully tested and certified to all requirements of ASSE Standard 1072*.</p>
<p>2. How do beer and soda affect the device; will it stick together?</p>	<p>The Quad Close device is made from a specifically formulated elastomeric material. This proprietary material helps prevent the substances from sticking to the surface of the device.</p>
<p>3. How is it affected by debris such as cigarette butts, peanut shells, etc?</p>	<p>For this type of debris, the floor drains should be specified with a bucket** that will prevent most of the debris from entering the drain line and clogging the drain. The type of grate openings furnished for the floor drains can also prevent debris from entering the drain. If debris does get past the bucket and grate, the opening in the Quad Close is large enough to allow most debris to pass through into the drain.</p> <p>**A bucket cannot be used with the 2692-0350 or any other version used in a strainer head.</p>
<p>4. What drain and pipe dimensions will the Quad Close fit?</p> 	<p>The Quad Close has been designed to handle a wide range of pipe and internal drain body diameters. The 2692 fits inside 1-1/2", 2", 3", 4" & 6" PVC and cast iron pipe. The 3-1/2" size fits into a strainer with a nominal inside diameter of 3-1/2".</p>
<p>5. What are the flow rates of the Quad Close?</p> 	<p>The flow rates for the Quad Close Trap Seal Device:</p> <ul style="list-style-type: none"> 1.50" - 6 GPM 2.00" - 12 GPM 3.00" - 34 GPM (The larger flow is due to the Quad Close being lower in the drain body). 3.50" - 51 GPM (The Quad Close is installed in the strainer). 4.00" - 73 GPM 6.00" - 215 GPM <p>Note: All flow rates were established per the requirements of ASSE Standard 1072.</p>

Visit www.jrsmith.com to see our product offering and other resources.

Patent No. 8,844,572



JAY R. SMITH MFG. CO.
MEMBER OF MORRIS GROUP INTERNATIONAL

Plumbing and Drainage Products
P.O. Box 3237 • Montgomery, AL 36109-0237
Tel 800-467-6484 • 334-277-8520
Fax 334-272-7396

www.jrsmith.com



MORRIS GROUP
INTERNATIONAL
www.morrisgroup.co

SPM 0502-1410