



Hydroxyl Ozone Generator Air & Surface Treatment System



HO3 2500 User Manual

IMPORTANT SAFETY INSTRUCTIONS

Carefully read the important safety and maintenance information.
Keep these instructions for future reference.

These instructions contain important safety and operating information for your Newaire HO3 2500 Hydroxyl Ozone Generator. Please contact us directly with questions you may have regarding the safe operation and/or maintenance.

Toll Free #: 1-877-646-9663

Table of Contents

Important Safety Information	2
Ozone Warning	3
Handling and Disposal of Mercury	4
FAQs	5
Location of Controls	6
Operation	7
Replacing the Carbon Filters	9
Replacing the UV Bulbs	10
Replacing the Generator Tubes	13
Fuses	14
Cleaning	14
Replacement Parts	14
Specifications	15
Troubleshooting	15
Limited Warranty	16

Important Safety Information



DANGEROUS VOLTAGE: The lightning flash with arrowhead symbol within an equilateral triangle is intended to alert the user to the presence of uninsulated dangerous voltage within the product's enclosure that may be of sufficient magnitude to constitute a risk of electric shock to persons.



ATTENTION: The exclamation point within an equilateral triangle is intended to alert the user to the presence of important operating and maintenance (servicing) instructions in the literature accompanying this product.

WARNING: TO PREVENT FIRE OR SHOCK HAZARD, DO NOT EXPOSE THIS UNIT TO RAIN OR MOISTURE.

WARNING: Use this Hydroxyl Generator only for its intended purpose as described in this Owner's Manual.

FCC WARNING: This equipment may generate or use radio frequency energy. Changes or modifications to this equipment may cause harmful interference unless the modifications are expressly approved in the instruction manual. The user could lose the authority to operate this equipment if an unauthorized change or modification is made.

This device complies with part 15 of the FCC Rules. Operation is subject to the following two conditions: (1) This device may not cause harmful interference, and (2) this device must accept any interference received, including interference that may cause undesired operation.

NOTE: This equipment has been tested and found to comply with the limits for a Class B digital device, pursuant to part 15 of the FCC Rules. These limits are designed to provide reasonable protection against harmful interference in a residential installation. This equipment generates, uses and can radiate radio frequency energy and, if not installed and used in accordance with the instructions, may cause harmful interference to radio communications. However, there is no guarantee that interference will not occur in a particular installation. If this equipment does cause harmful interference to radio or television reception, which can be determined by turning the equipment off and on, the user is encouraged to try to correct the interference by one or more of the following measures:

- Reorient or relocate the receiving antenna.
- Increase the separation between the equipment and receiver.
- Connect the equipment into an outlet on a circuit different from that to which the receiver is connected.
- Consult the dealer or an experienced radio/TV technician for help.

WARNING: DO NOT look directly at UV bulbs.

INDUSTRY CANADA NOTICE:

This device complies with Industry Canada license-exempt RSS standard(s). Operation is subject to the following two conditions:
1. This device may not cause interference, and
2. This device must accept any interference, including interference that may cause undesired operation of the device.

CAN ICES-3(B)/NMB-3(B)

Important Safety Information

Standard safety precautions must always be followed to reduce the risk of fire, electric shock, and injury to persons, including the following:

1. Read these Instructions.
2. Keep these Instructions.
3. Heed all Warnings.
4. Follow all Instructions.
5. Do not use this apparatus in or near water.
6. Clean only with a damp cloth.
7. Do not block any of the ventilation openings. Install in accordance with the Manufacturer's instructions.
8. Do not install near any heat sources such as radiators, heat registers, stoves, or other apparatus (including amplifiers) that produce heat.
9. Do not defeat the safety purpose of the polarized or grounding-type plug. A polarized plug has two blades with one wider than the other. A grounding type plug has two blades and a third grounding prong. The wide blade or the third prong are provided for your safety. When the provided plug does not fit into your outlet, consult an electrician for replacement of the obsolete outlet.
10. Protect the power cord from being walked on or pinched particularly at plugs, convenience receptacles, and the point where they exit from the apparatus.
11. Only use attachments/accessories specified by the manufacturer.
12. Use only with a cart, stand, tripod, bracket, or table specified by the manufacturer, or sold with the apparatus. When a cart is used, use caution when moving the cart/apparatus combination to avoid injury from tip-over.
13. Unplug this apparatus during lightning storms or when unused for long periods of time.
14. Refer all servicing to qualified service personnel. Servicing is required when the apparatus has been damaged in any way, such as power-supply cord or plug is damaged, liquid has been spilled or objects have fallen into the apparatus, the apparatus has been exposed to rain or moisture, does not operate normally, or has been dropped.
15. **WARNING:** To reduce the risk of fire or electric shock, do not expose this apparatus to rain or moisture. Do not

PORTABLE CART WARNING
(symbol provided by RETAC)



place objects filled with water, such as a vase, on the apparatus.

16. The AC mains plug is used as the power disconnect device and it should remain readily accessible and operable during intended use. In order to completely disconnect the apparatus from power, the mains plug should be completely removed from the AC outlet socket.
17. Keep the cord out of heavy traffic areas. To avoid fire hazard, NEVER put the cord under rugs, near heat registers, radiators, stoves, or heaters.
18. DO NOT operate any generator with a damaged cord or plug, if motor fan fails to rotate, after the generator malfunctions, or if it has been dropped or damaged in any manner. Return generator to manufacturer or authorized repair facility for examination, electrical or mechanical adjustment, or repair.
19. Do not leave the generator in use unattended around those requiring close supervision.
20. **WARNING!** Always unplug the generator before moving it, cleaning, or whenever the generator is not in use. Be sure to pull by the plug and not the cord.
21. This Hydroxyl Generator is for Indoor Use Only.
22. Do not attempt to repair or adjust any electrical or mechanical functions on this unit other than the UV bulbs and Carbon Filters. Doing so will void your warranty. All servicing should be performed by qualified personnel only.
23. Do not place anything on top of generator.
24. Do not plug the cord in with wet hands: electric shock could result.
25. NEVER use detergents, gasoline, glass cleaner, furniture polish, paint thinner or other household solvents to clean any part of the generator.
26. See separate safety instructions (pages 4 and 5) for replacing the UV Lamp with mercury.
27. For General Ventilating Use Only. Do Not Use to Exhaust Hazardous or Explosive Materials and Vapors.

**PLEASE READ AND SAVE THESE
IMPORTANT SAFETY INSTRUCTIONS**

OZONE WARNING

For the Ozone feature, make certain all people, pets and plants are out of the area. Close all windows and doors and do not allow entry of the area.

Handling and Disposal of Mercury

Mercury is used in this device's UV bulb and must be disposed of properly. There is no safety hazard as long as the bulb is intact because the mercury is contained within the fixture. If a bulb breaks, very little mercury could be released. This is different than liquid metallic mercury (like in a thermometer), which is hazardous due to its potential to release mercury vapor. In humans, approximately 80% of inhaled mercury vapor is absorbed through the respiratory tract, where it enters the circulatory system and is distributed throughout the body. Short term exposure to this small amount of spilled mercury does not pose a health hazard, provided that the source of the mercury is removed promptly. Chronic exposure by inhalation, even at low concentrations in the range 0.7–42 µg/m³, can cause effects such as tremors, impaired cognitive skills, and sleep disturbance. The OSHA limit for occupational exposure of elemental mercury is 0.1 µg/m³. Mercury is used in most fluorescent light fixtures.

If the UV bulb does not function, the bulbs should be checked to ensure that they are intact. If the bulb is cracked, but not broken, it must be replaced. Cracked bulbs should be double sealed in plastic bags and disposed of according to local, approved procedures. If the bulb breaks and the mercury is spilled, clean-up must be done immediately according to the following procedure published by the Environment Protection Agency:

- People and pets must leave the room.
- **DO NOT VACUUM.** Vacuuming is not recommended unless broken glass remains after all other cleanup steps have been taken. Vacuuming could spread mercury-containing powder or mercury vapor. Do not attempt to clean up the spill with a mop or broom either.
- Dispose of clothing, fabric, etc. that has come in contact with mercury; do not wash.
- Close the doors to the area of the spill and shut off the central forced air heating/air-conditioning system. Open exterior windows and direct room air out of the window with fans or use an exhaust fan (if the area is equipped with one) that vents directly outdoors.
- Cover shoes with disposable foot covers or wear shoes that will be disposed of.
- Remove jewelry as mercury can ruin them.
- Use a commercial mercury spill clean-up kit to remove the spilled mercury. If one is not available, you can also use Stiff cardboard, Sticky Tape, Damp Paper Towels, Disposable Wet Wipes and a Glass Jar with a Metal Lid or a Sealable Plastic Bag.
- Identify items in the spill area that can be cleaned and those that cannot. Non-porous surfaces (finished wood, plastic or concrete) can be cleaned following this guidance. Porous surfaces or fabric-covered items (upholstery, carpeting, stuffed animals, pillows, backpacks, unfinished wood, cork, cardboard) are difficult to clean because mercury beads may be trapped in these materials. If you decide you cannot clean these items, place them in plastic trash bags or cover or wrap them in a double layer of plastic and carefully seal with tape. Place the wrapped items in a secure place, preferably outdoors and out of the reach of children and pets. You should consult with a trained professional about how to decontaminate or dispose of these items safely.
- Wear gloves to carefully pick up the larger pieces of broken glass and what remains of the broken device and place them on a paper towel. Gently fold the paper towel around these pieces so you can pick the bundle up and place it in a zipper-type plastic bag. Use index cards or stiff cardboard to push smaller pieces of glass and mercury beads together into a pile. Shine a flashlight at an angle to locate beads of mercury. The beads will reflect light from the flashlight. Check for mercury in cracks or in hard-to-reach areas where beads may be hidden or trapped. Check a wide area beyond the spill.
- Use the eyedropper to collect mercury beads and place them in the plastic bag. Hold the eyedropper at an angle to draw the mercury into the tip. Keep the eyedropper at an angle to stop the mercury from rolling back out until you can put the mercury into the plastic bag. Wrap tape (sticky side out) around your gloved fingers and carefully use it to pick up any remaining glass or beads. Check again with the flashlight to be sure that no beads of mercury remain.
- At this point, mercury beads may still be trapped in cracks or crevices on irregular surfaces. Sprinkle sulfur powder over the contaminated area and rub it gently all over the surface and into the cracks with a paper towel. Sulfur powder binds with mercury. Use a paper towel dampened with water followed by wiping with another damp paper towel to clean up the sulfur and mercury. Place the used paper towels in a zipper-type plastic bag.
- Put all the items that were used to pick up the mercury, including index cards or cardboard, eyedropper, contaminated tape, paper towels, and zipper-type bags into the trash bag. Carefully remove rubber gloves by grabbing them at the wrist and pulling them inside out as they come off. Place the used gloves in the trash bag.
- Carefully seal the trash bag that contains the mercury contaminated waste and put it in a secure place, preferable outdoors and out of reach of children and pets until it can be disposed of safely.

Continued on the Next Page

Handling and Disposal of Mercury

- After cleaning, open a window and use a fan to ventilate the area to the outdoors for 24-48 hours before resuming normal use. Avoid blowing the exhaust back indoors or into other nearby residences.
- Clothes or shoes that did not come in direct contact with liquid mercury should be removed and put into the trash bag that was left outside the contaminated area at the beginning of the cleanup. Close the trash bag and take it outdoors. Carefully remove the shoes and or clothing from the trash bag and air them out thoroughly outdoors for 24 to 48 hours. After the outdoor airing, items that are washable can then be laundered.
- Continue to air out the room where the bulb was broken and leave the heating/air conditioning system shut off for several hours.
- Dispose of contaminated items properly! Mercury-contaminated items should not be placed in the regular household trash. Contact your town or county officials for information about hazardous waste disposal in your community.
- Call your local health department as soon as possible. If it is after-hours, please call your local fire department. If you have questions about potential health effects, you can call your physician, or your local poison control center at 1-800-222-1222.

FAQs

What are Hydroxyls?

Hydroxyl radicals quickly decompose chemicals in the air to keep the atmosphere clean of harmful compounds and are created naturally in the atmosphere when the sun's ultraviolet rays react with water vapor and oxygen. Hydroxyl Ozone generators like this one use the same UV radiation as the sun and are used to naturally clean and deodorize indoor environments.

What is Ozone?

Ozone is very effective in eliminating odors including tobacco smoke, human and pet odors, food odors, mold and mildew odors, garbage odors, renovation odors and much more. It is not a re-odorant. Ozone totally destroys the offending gases that are the source of everything we smell. Unlike many other deodorizing methods, ozone actually searches out and destroys the problem gases. It will react with contaminants in the air, water, fabrics and on other surface of the walls and ceilings.

Why is cleaning the air important?

Air pollutants can cause allergies, sick building syndrome (buildings with contaminants at harmful concentrations), bacteria infections, and spread viruses to name a few. Use of this unit will help reduce the chances of contracting one of these illnesses.

Is it safe to be around this generator when operating?

The Hydroxyl feature is safe to use in occupied areas for deodorization purposes. This is great as businesses do not have to shut down, people do not have to leave their dwellings, etc.

For the Ozone feature, make certain all people, pets and plants are out of the area. Close all windows and doors and do not allow entry of the area.

How much area will the unit cover?

This unit will cover approximately 2500 square feet.

How long does it take for hydroxyl deodorization or ozone to work?

Deodorization can take just minutes into the start of machine operation. Naturally, other factors need to be taken into consideration such as the size of the layout, airflow, size, and the intensity of the problem. With odors, usually, this unit can permanently eradicate them within a few days.

Is humidity good or bad to have with this unit?

Good! The higher the treatment area's humidity, the more hydroxyls will be produced and the better/quicker the Hydroxyl Ozone generator will do the job. Hydroxyls are not temperature sensitive and like higher humidity.

What maintenance is required?

Very little. Simply replace the UV lamps when they burn out (see page 10) and replace the carbon filters after approximately 60 days of use (see page 9). You can also clean as described on page 12.

Are there safety precautions to be observed?

Yes, see pages 2 to 5. Particularly, do NOT look directly at the UV light, this is very important.

How long is the warranty?

The is a limited time warranty of 2 years, see page 14 for specifics.

Location of Controls

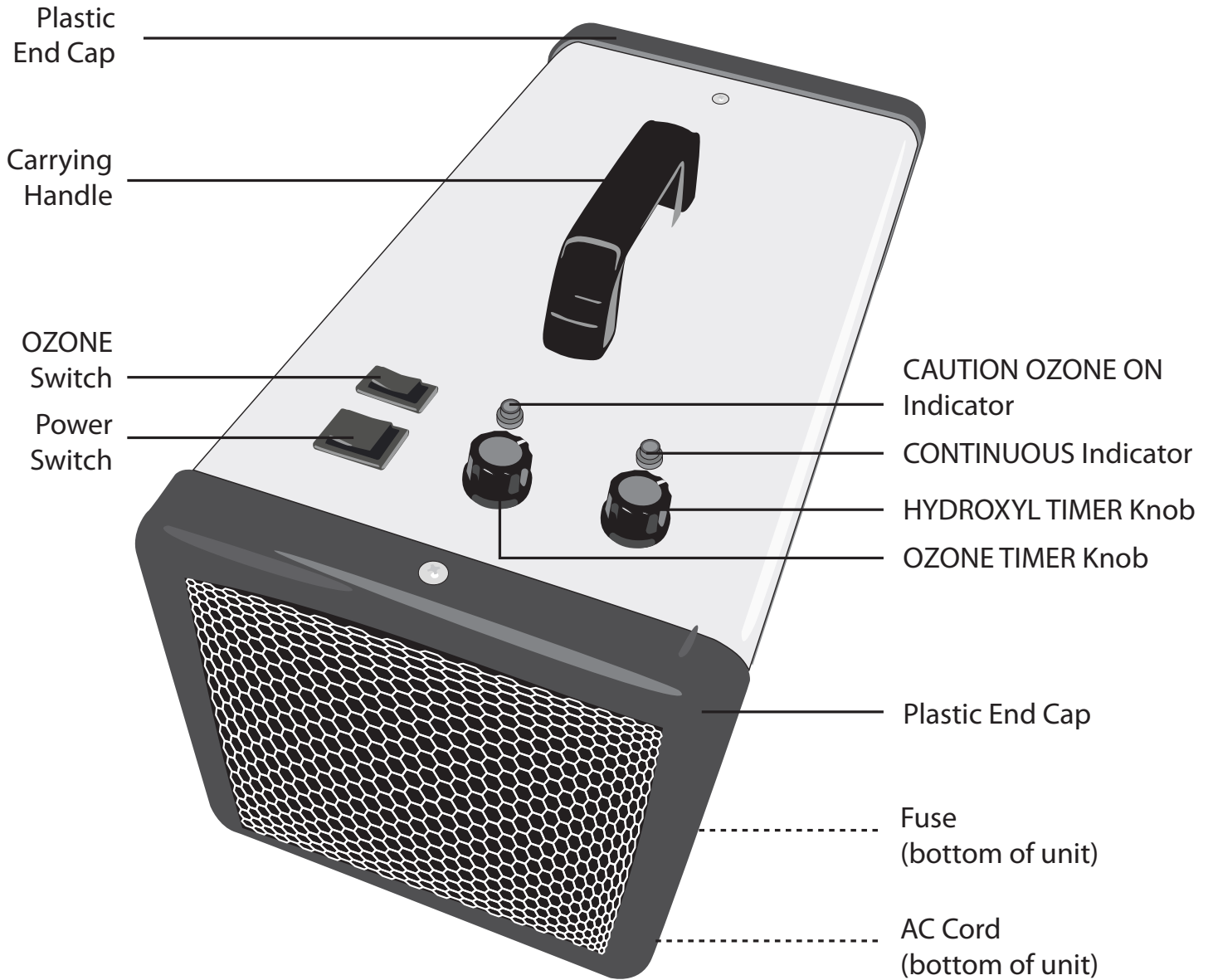

Operation

AC CONNECTION

- 1 Plug into properly installed and grounded three-prong outlet. See safety precautions as follows.

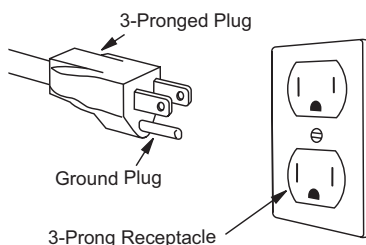

Grounding Instructions

THIS APPLIANCE MUST BE GROUNDED.

In the event of an electrical short circuit, grounding reduces the risk of electric shock by providing an escape wire for the electric current. This appliance is equipped with a cord having a grounding wire with a grounding plug. The plug must be plugged into an outlet that is properly installed and grounded.

- Plug into properly installed and grounded three-prong outlet.
- DO NOT remove ground prong.
- DO NOT use an adapter.

Power Supply

- Extension cords can be used only if:
 - (1) the marked electrical rating of the extension cord is at least as great as the electrical rating of the appliance,
 - (2) the extension cord must be a grounding-type three-wire cord, and
 - (3) the longer cord should be arranged so that it will not drape over the countertop or tabletop.

STANDARD OPERATION

- 1 Press the Power Switch to the ON position and the Hydroxyl Ozone Generator will operate continuously until the Power switch is set to OFF. The Continuous indicator will light when the switch is set to ON.

NOTE: The Ozone feature cannot be used while in the Continuous mode.



- 2 When done, press the Power Switch to the OFF position and the fan and UV bulbs will turn off.



Operation

TIMER OPERATION

1

Press the Power Switch to the TIMER position.



2

HYDROXYL: Set the desired hydroxyl time using HYDROXYL TIMER Knob.

The Hydroxyl Ozone Generator will operate until the set timer time is reached. Note the Continuous indicator will NOT light when in the timer mode. When the timer time has been reached, the fan and UV bulbs will turn off.



3

OZONE: (Can only be used when Hydroxyl Timer is set also, and room must be empty of people, pets and plants). Set the desired ozone time using OZONE TIMER Knob, then press the OZONE TIMER knob to the desired time; the CAUTION OZONE ON indicator will light.

The Hydroxyl and Ozone functions will operate until the set timer time(s) are reached; the fan and UV bulbs will turn off.



4

When done, press the Power Switch to the OFF position and the fan and UV bulbs will turn off.



Replacing the Carbon Filters

After approximately 60 days of use, both carbon filters should be replaced. The carbon filters are located at each end of the Hydroxyl Ozone Generator and can be purchased through your distributor. Replace carbon filters as follows:

- 1** **WITH THE UNIT UNPLUGGED**, place the Hydroxyl Ozone Generator vertically with the controls facing up and remove the two retaining screws, one on each side of the Plastic End Cap.



- 2** Gently remove the Plastic End Cap, screen and carbon filter. Place used carbon filter in a plastic bag and dispose of.

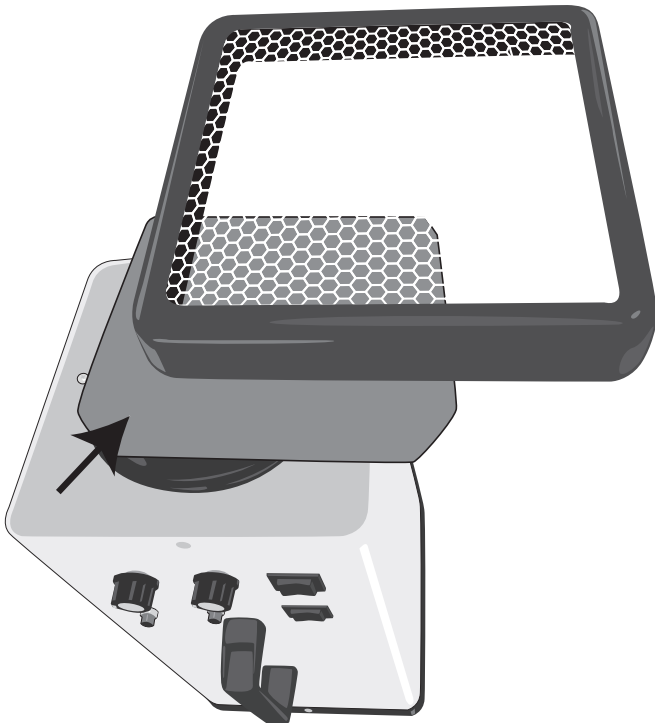

- 3** Install the new carbon filter, then replace the screen and plastic end cap.

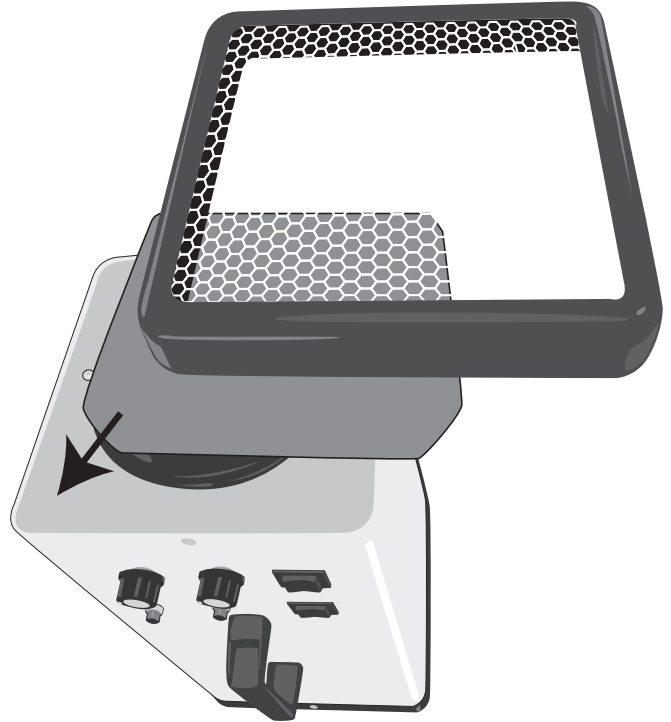

- 4** Re-insert the two screws.



- 5** Repeat for the other carbon filter located on the opposite side.

IMPORTANT

The unit should never be operated without the screen or carbon filter in place.

Replacing the UV Bulbs

When one of UV bulbs blows, you must replace both at the same time. The UV bulbs can be purchased through your distributor. Replace UV bulbs as follows:

- 1** **WITH THE UNIT UNPLUGGED**, place the Hydroxyl Ozone Generator vertically with the controls facing up and remove the two retaining screws as shown, one on each side of the plastic end cap.



- 2** Gently remove the plastic end cap, screen and carbon filter.

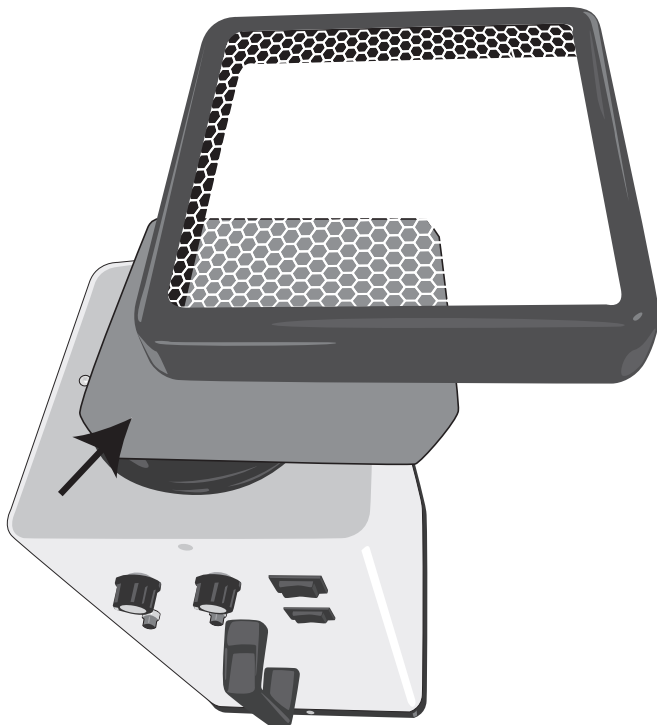

- 3** Remove one of the 8/32 screws holding the finger guard in its place and loosen the opposing screw. Rotate finger guard 180° so it is out of the way to access the UV Bulb area.



- 4** Loosen both socket head screws using a 3/32 Allen key, then gently remove them by hand while securing the head socket.



Replacing the UV Bulbs

5

Gently pull the UV lamp socket vertically holding the lamp by ceramic portion and disconnect the Quick Connect connector.

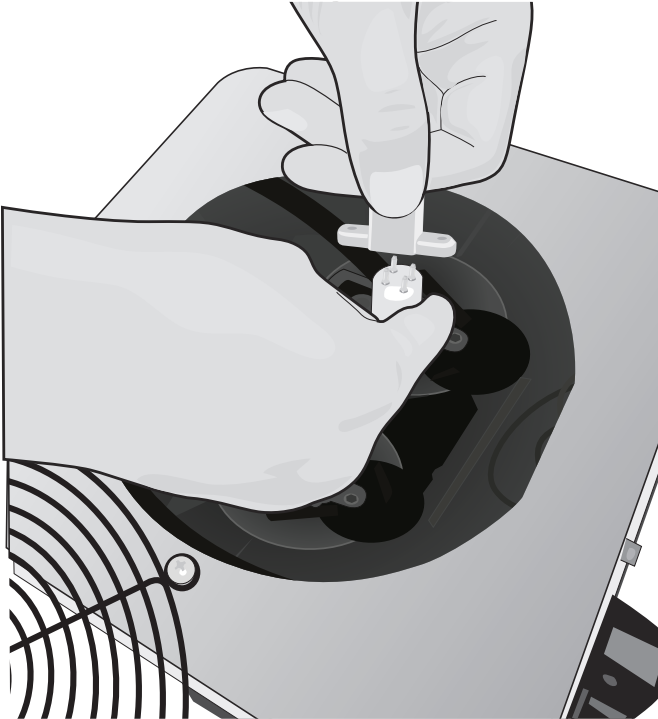

7

Reconnect the UV Lamp, then reinsert socket head screws and gently tighten with 3/32 Allen key.



6

Replace the UV lamp with the new bulb by carefully sliding lamp into lamp holder, making sure to align the bottom end of the UV bulb into the bottom recess.

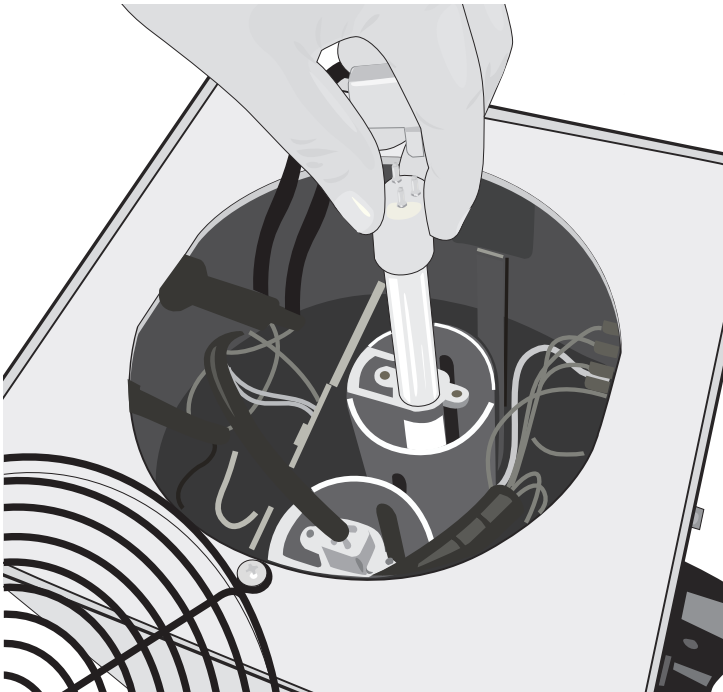

8

Repeat process with the second UV lamp as they should be replaced in pairs.

9

Rotate finger guard back in place and secure with retaining screw. Make sure both screws are gently secured.



IMPORTANT:

- Care should be taken not to touch the UV lamp glass. Disposable gloves are supplied in the UV lamp kit.

Replacing the UV Bulbs

10

Reinsert carbon filter, metal retaining screen, and plastic end cap, then secure with retaining screws.

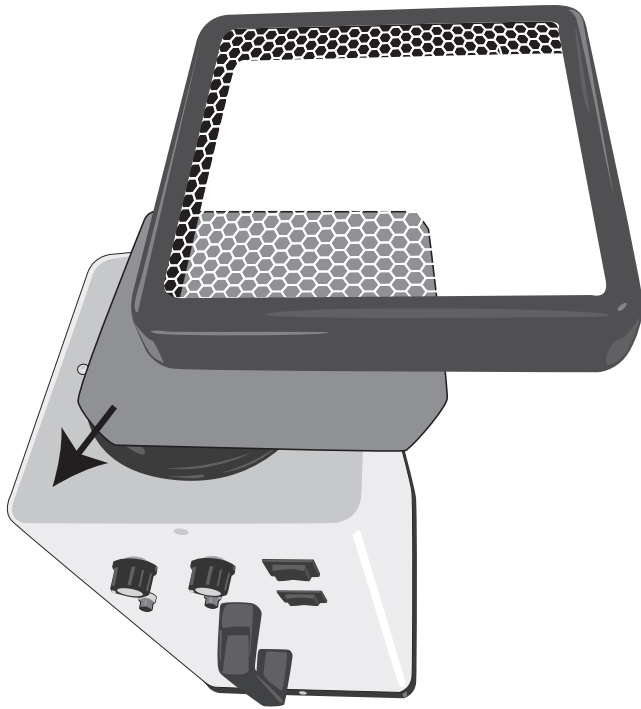

WARNING:

- UV Bulbs MUST be disposed of properly, see pages 4 and 5 for details on removing the mercury containing UV bulbs.

Replacing the Generator Tubes

Maintenance is required on the ozone generator about every six months depending on the amount of use and/or if the ozone output is low or the ozone generator 1 Amp fuse has blown.

- 1** **WITH THE UNIT UNPLUGGED**, place the Hydroxyl Ozone Generator vertically with the controls facing up and remove the two retaining screws as shown, one on each side of the plastic end cap. Repeat for other end cap.



- 2** Remove five countersunk Phillips head machine screws, located on each side of upper cabinet and one placed between handle and control panel. Lift upper cabinet cover clear of the machine.

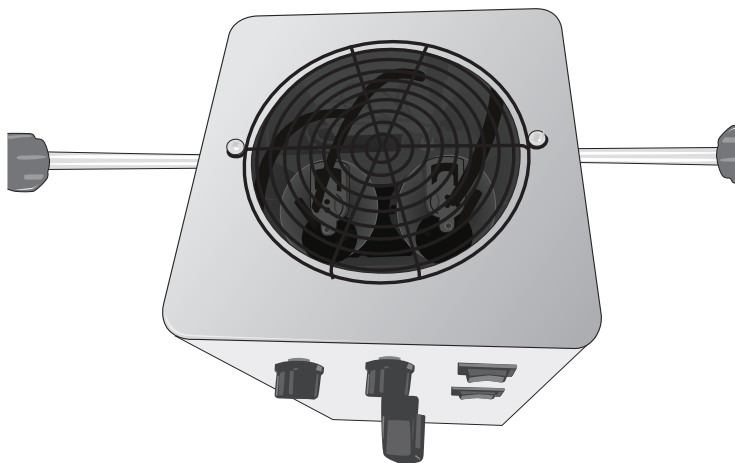

- 3** Remove two screws (one on each generator tube). Loosen (do not remove) the screw in the middle of the tubes holding the titanium electrode to the wire assembly.

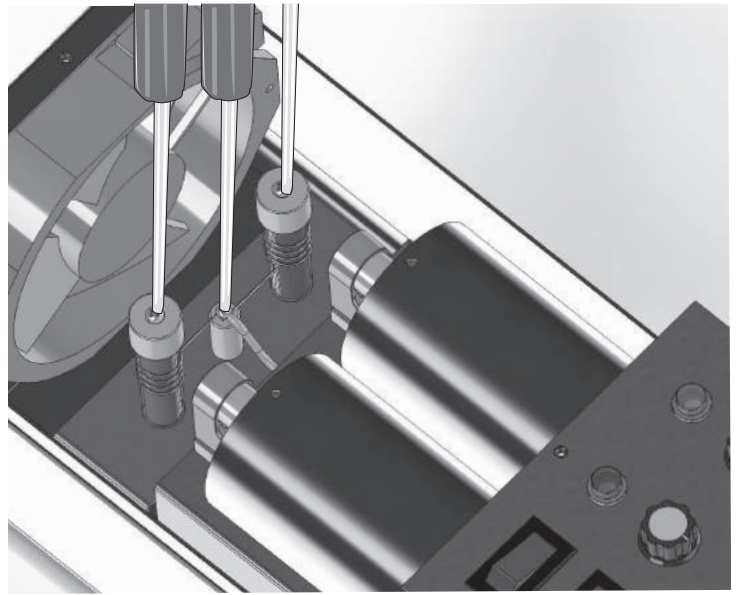

- 4** Remove ozone generator tube and electrode. Gently remove dust and particulate build up from around the generator assembly.

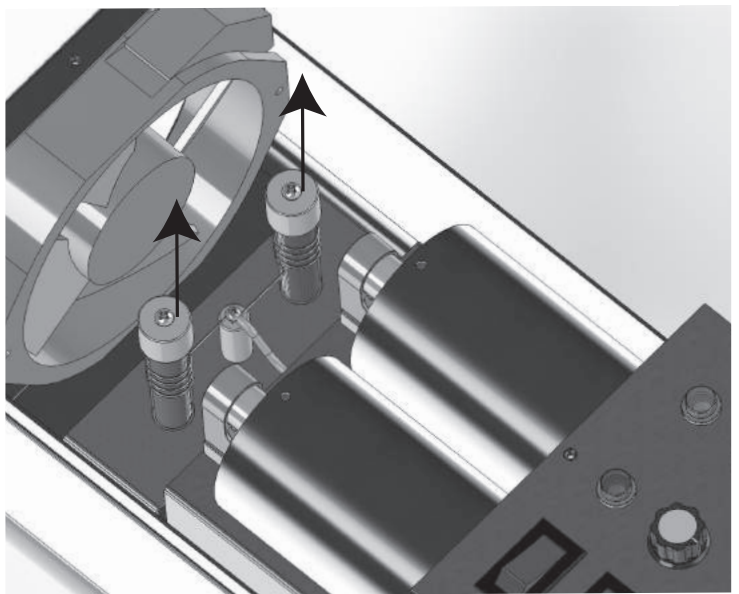

Replacing the Generator Tubes

5

Examine and replace the ozone generator tubes and electrodes if ozone output is low and any damaged or broken parts, or if the 1 Amp fuse has blown. Make sure to connect the grounding wire to wire assembly.

6

Reassemble in reverse order.

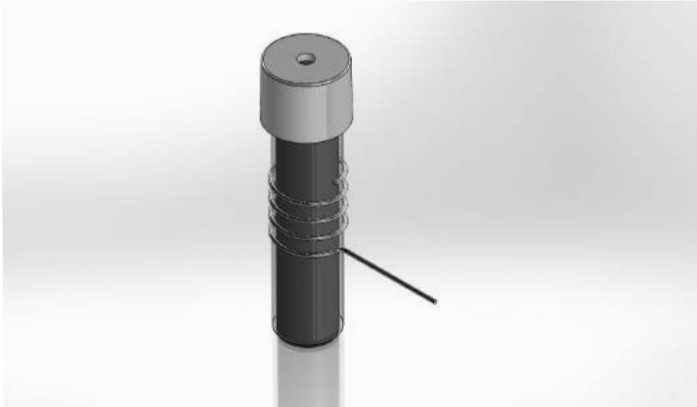

IMPORTANT:

- Caution should be taken when sliding ozone generator tube over the counter electrode.
- Do not over tighten ozone generator tube and electrode screws.

Fuses

WARNING:

- Make sure the unit is unplugged before replacing fuses.

If the 2 Amp fuse has blown, replace the UV Bulbs as shown on page 10. The 2 Amp fuse is the one in the middle of the bottom cabinet.

If the 1 Amp fuse has blown, replace the Generator Tubes as shown on page 13. The 1 Amp fuse is the left one on the bottom cabinet.

Cleaning

WARNING:

- Make sure the unit is unplugged before maintenance is performed.

Cleaning

To clean, use a damp soapy cloth for standard cleaning.

Replacement Parts

To order replacement parts, contact your distributor or call 1 - 866 - 676 - 9663 for assistance.

Specifications

Power Source.....	120 V, 60 Hz
Power Consumption.....	132 Watts
Fan Output	212 CFM
Treatment Process	Carbon filter & twin hydroxyl and ozone chambers
UV Lamp Type.....	UVC 254 nm germicidal lamp
Reaction Surface.....	266.90 Square Inches, 25,000 Hour Life
Room Capacity.....	2500 Square Feet
Dimensions.....	8.2 (W) x 10 (D) x 17 (L) inches
Weight	11Lbs
Ozone Output.....	1GPH

Specifications subject to change without notice.

Troubleshooting

UV Lamps not functioning.

- The life of the UV bulb may have been met or damaged. If they are burnt out, replace both bulbs as shown on pages 10 to 12. If broken, refer to pages 4 and 5 for Handling and Disposal of Mercury.
- Fuse has blown. Unplug and turn over unit to access fuse. Rotate fuse holder and replace with 2 Amp fuse.
- Internal Component failure; call 1-866-676-9663 for service.

Generator is not performing well.

- The life of the carbon filter may have been met or damaged; replace both carbon filters, see page 9.
- The life of the UV bulb may have been met or damaged. If they are burnt out, replace both bulbs as shown on pages 10 to 12. If broken, refer to pages 4-5 for Handling and Disposal of Mercury.
- Internal Component failure; call 1 - 866 - 676 - 9663 for service.

Generator not working at all

- Unit is not plugged in, or power is not active at the AC socket.
- 2 Amp Fuse has blown. Unplug and turn over unit to access fuse. Rotate fuse holder and replace with 2 Amp fuse.
- 1 Amp Fuse has blown. Unplug and turn over unit to access fuse. Rotate fuse holder and replace with 1 Amp fuse.
- Timer time is up. Press the Power switch to the OFF position and then to the TIMER or ON position.
- If Ozone is not working, make sure the Power switch is set to the TIMER position, the HYDROXYL TIMER knob is set and finally, make sure the OZONE TIMER knob is set.

Limited Warranty

PURCHASER PLEASE FILL OUT AND FAX TO 1-800-493-4550 OR

MAIL TO:

QUEENAIRE TECHNOLOGIES, INC
9483 State Highway 37, Ogdensburg, NY 13669

MODEL # _____ SERIAL # _____ DATE PURCHASED _____

PURCHASED FROM _____ INTENDED USE _____

CUSTOMER NAME _____ TELEPHONE _____

ADDRESS _____ FAX _____

CITY/STATE/ZIP _____ CONTACT NAME _____

QUEENAIRE TECHNOLOGIES, INC WARRANTS NEW QUEENAIRE MODELS TO THE ORIGINAL PURCHASER ONLY, TO BE FREE FROM DEFECTS IN MATERIALS AND WORKMANSHIP WHEN USED PROPERLY, FOR A PERIOD OF 2 YEARS FROM THE DATE OF ORIGINAL PURCHASE AGAINST DEFECTS, NOT AGAINST BREAKAGE; EXCEPT AS NOTED IN THE POLICY BELOW. ANY REPAIR IS WARRANTED TO THE PURCHASER ONLY FOR THE LENGTH OF THE UNEXPIRED PORTION OF THE ORIGINAL WARRANTY.

THIS LIMITED WARRANTY APPLIES ONLY WITH RESPECT TO DEFECTS IN MATERIAL AND WORKMANSHIP UNDER NORMAL AND PROPER USE OF THE UNIT IN ITS UNMODIFIED CONDITION. THIS WARRANTY SHALL NOT APPLY TO ANY UNIT WHICH HAS BEEN SUBJECTED TO ALTERATION, MISUSE, NEGLIGENCE, OR ACCIDENT, OR DAMAGE RESULTING FROM IMPROPER SERVICE BY AN UNAUTHORIZED SERVICE REPAIR PERSON. WARRANTY SERVICE MAY ONLY BE PERFORMED BY AN AUTHORIZED WARRANTY REPAIR CENTER. AT THE TIME REQUEST FOR REPAIR IS MADE, EVIDENCE OF THE DATE OF PURCHASE AND DATES OF MAINTENANCE WORK MUST BE PROVIDED UPON REQUEST. TRANSPORTATION COSTS SHALL BE BORNE BY THE PURCHASER OF THE EQUIPMENT.

THE EXPRESS WARRANTY SET FORTH HEREIN IS IN LIEU OF ALL OTHER WARRANTIES, WHETHER EXPRESS OR IMPLIED, INCLUDING, BUT NOT LIMITED TO, IMPLIED WARRANTIES OF MERCHANTABILITY AND FITNESS FOR A PARTICULAR PURPOSE. ALL SUCH IMPLIED WARRANTIES, INCLUDING WARRANTIES OF MERCHANTABILITY AND FITNESS FOR A PARTICULAR PURPOSE, ARE HEREBY EXPRESSLY EXCLUDED AND DISCLAIMED, EXCEPT AS LIMITED IN ACCORDANCE WITH THE TERMS OF THE EXPRESS WARRANTY GRANTED HEREIN.

WITH EXCEPTION OF DAMAGES RESULTING FROM QUEENAIRE TECHNOLOGIES FAILURE TO COMPLY WITH ANY OBLIGATION UNDER FEDERAL OR STATE WARRANTY LAW, QUEENAIRE TECHNOLOGIES SHALL NOT BE LIABLE TO THE PURCHASER OR TO ANYONE ELSE FOR DAMAGES INCLUDING, BUT NOT LIMITED TO, CONSEQUENTIAL DAMAGES AND DAMAGES BY REASON OF INJURY TO ANY PERSON DUE TO ANY DEFECT IN OR THE MALFUNCTION OF THE UNIT OR ANY PART OR PARTS THEREOF, OR FOR ANY OTHER REASON. THIS WARRANTY GIVES CERTAIN LEGAL RIGHTS AND THE PURCHASER MAY ALSO HAVE OTHER RIGHTS WHICH MAY VARY FROM STATE TO STATE OR PROVINCE TO PROVINCE.

NO SELLER OR DEALER FOR QUEENAIRE TECHNOLOGIES OR FOR THE UNIT, HAS ANY AUTHORITY TO MAKE ANY REPRESENTATION OR PROMISE ON BEHALF OF QUEENAIRE TECHNOLOGIES OR TO ASSUME ANY LIABILITY FOR QUEENAIRE TECHNOLOGIES, OR TO MODIFY THE TEXT OF THE WARRANTY PROVIDED HEREIN.

QUEENAIRE TECHNOLOGIES, INC

Toll Free: 1-866-676-9663 Toll Free Fax: 1-800-493-4550

www.queenaire.com

newaire™

QUEENAIRE TECHNOLOGIES, INC
9483 State Highway 37
Ogdensburg, NY 13669

www.queenaire.com