

Volume I: Vinyl Process Piping Systems

Industrial Technical
Manual Series

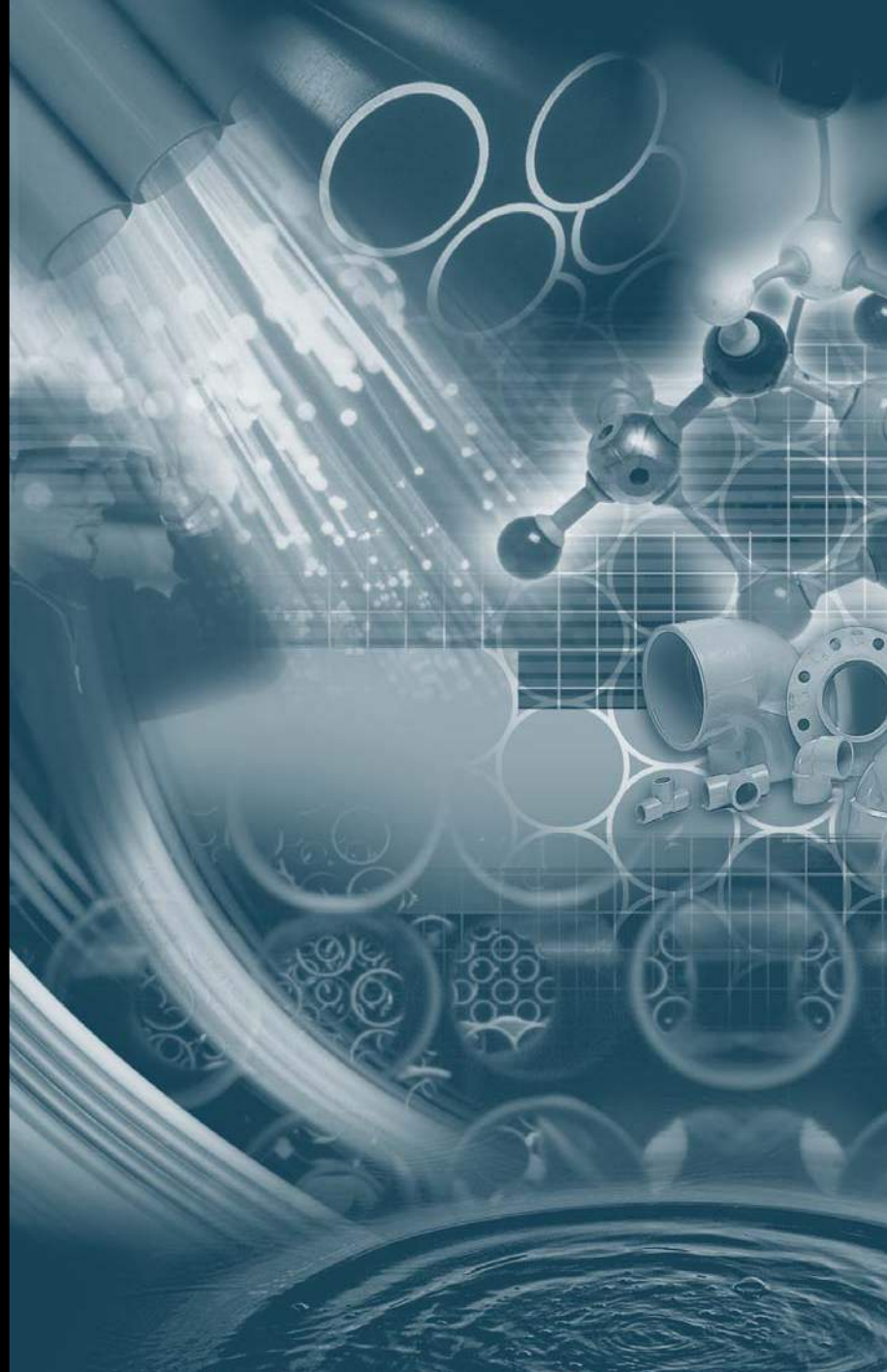

SIXTH EDITION

IPEX VINYL PROCESS PIPING SYSTEMS

- Xirtec®140 PVC Schedule 40
- Xirtec®140 PVC Schedule 80
- Corzan® CPVC



IPEX

IPEX Vinyl Process Piping Systems

Industrial Technical Manual Series

Vol. 1, 6th Edition

© 2013 by IPEX. All rights reserved. No part of this book may be used or reproduced in any manner whatsoever without prior written permission. For information contact: IPEX Management Inc., 2441 Royal Windsor Drive, Mississauga, Ontario, Canada, L5J 4C7.



ABOUT IPEX

At IPEX, we have been manufacturing non-metallic pipe and fittings since 1951. We formulate our own compounds and maintain strict quality control during production. Our products are made available for customers thanks to a network of regional stocking locations throughout North America. We offer a wide variety of systems including complete lines of piping, fittings, valves and custom-fabricated items.

More importantly, we are committed to meeting our customers' needs. As a leader in the plastic piping industry, IPEX continually develops new products, modernizes manufacturing facilities and acquires innovative process technology. In addition, our staff take pride in their work, making available to customers their extensive thermoplastic knowledge and field experience. IPEX personnel are committed to improving the safety, reliability and performance of thermoplastic materials. We are involved in several standards committees and are members of and/or comply with the organizations listed on this page.

For specific details about any IPEX product, contact our customer service department.



SAFETY ALERTS

Engineered thermoplastics are safe inert materials that do not pose any significant safety or environmental hazards during handling or installation. However, improper installation or use can result in personal injury and/or property damage. It is important to be aware of and recognize safety alert messages as they appear in this manual.

The types of safety alert messages are described below.



This safety alert symbol indicates important safety messages in this manual. When you see this symbol be alert to the possibility of personal injury and carefully read and fully understand the message that follows.



WARNING

“WARNING” identifies hazards or unsafe practices that can result in severe personal injury or death if instructions, including recommended precautions, are not followed.



CAUTION

“CAUTION” identifies hazards or unsafe practices that can result in minor personal injury or product or property damage if instructions, including recommended precautions, are not followed.

Note: The use of the word “NOTE” signifies special instructions which are important but are not related to hazards.

For the materials described in this manual, the following warning applies.



WARNING

- **NEVER** use compressed air or gas in PVC/CPVC/PP/PVDF pipe and fittings.
- **NEVER** test PVC/CPVC/PP/PVDF pipe and fittings with compressed air or gas, or air-over-water boosters.
- **ONLY** use PVC/CPVC/PP/PVDF pipe for water and approved chemicals.

Use of compressed air or gas in PVC/CPVC/PP/PVDF pipe and fittings can result in explosive failures and cause severe injury or death.



NOTES

CONTENTS

Vinyl Process Piping Systems Manual

About IPEX

Safety Alerts *i*

Section One: General Information

Overview7

Benefits8

Material Description10

Applications11

- Industrial and Process Piping

- Pulp and Paper

- Food Processing

- Water and Sewage Treatment

- Irrigation

Section Two: Process and Drainage Piping Design

Introduction13

Design Process14

 Establish System Requirements14

 Determine Appropriate Sizing14

 A) Pressure Limitations14

 B) Temperature Limitations23

 C) Pressure/Temperature Relationship23

Design Considerations24

 Expansion and Contraction24

 Water Hammer / Surge32

 Thermal Conductivity33

 Vacuum Service34

 Deflection37

 Drainage37

 Fittings38

 Valves40

Section Three: Installation

Introduction43

Handling and Storage44

 Prolonged Outdoor Exposure44

Joining Methods – Solvent Cement45

 Solvent Cementing Instructions for PVC and CPVC Pipe and Fittings47

Joining Methods – Threading	54
Characteristics	54
Tools & Equipment	54
Making the Pipe Thread	55
Installation Guidelines	55
Joining Methods – Flanging	57
Introduction	57
Dimensions	57
Installation Guidelines	57
Corzan® Full Pressure Flange Kit	58
Joining Methods – Roll Grooved or Radius Cut Grooved (PVC only)	61
Introduction	61
Features	61
Installation Guidelines	61
Supports and Restraints	63
Thrust	63
General Principals of Support	63
Supporting Pipes	64
Installation of Buried Pipes	69
Introduction	69
Trench Preparation	69
Trench Depth	69
Trench Bottom	70
Placing the Pipe	70
Snaking the Pipe	70
Assembly	70
Resisting Thrust	70
Initial Backfilling	71
System Testing	71
Compacting the Final Backfill	71
Testing	72
Site Pressure Testing	72
Hydrostatic Test Procedure	72
Repairs	73
Repairs Below Ground	73
Joint Repairs	73
Repairing Thermoplastic Pipe Joints	74

	Installation Considerations76
	Entrapped Air76
	Ultraviolet Light77
	Ozone77
	Chemical Resistance77
	Heat Tracing77
	Static Electricity77
	Tapping78
Section Four:	Specialty Piping Products	
	PVC Well Casing - ASTM F48079
	PVC Exhaust System Ducting80
Section Five:	Specifications	
	Standards81
	Standards Organizations81
	Applicable Standards81
	ASTM81
	NSF International84
	CSA International84
	NFPA/UL/ULC/ASTM – Burning84
	Product Specifications85
	Xirtec Sch. 40 & 80 PVC Industrial Pipe and Fittings85
	Corzan Sch. 40 & 80 CPVC Industrial Pipe and Sch. 80 CPVC Fittings85
	Corzan Full-Pressure Flange Kit86
	PVC SDR Pressure Rated Pipe87
	PVC Ventilation Duct Pipe87
	CPVC Ventilation Duct Pipe88
	Drain, Waste and Vent Pipe (DWV)88
	Fabricated Fittings89
	Solvent Cementing89
Section Six:	Appendices	
	Appendix A: Reference Tables and Conversion Charts91
	Appendix B: Useful Formulas101
	Appendix C: Glossary103
	Appendix D: Abbreviations108
	Appendix E: Tables and Figures109

NOTES

SECTION ONE: GENERAL INFORMATION

OVERVIEW

This manual provides the most up-to-date and comprehensive information about vinyl piping systems produced by IPEX. Written with the needs of the engineer and contractor in mind, all aspects of PVC and CPVC thermoplastics are covered. This includes material properties, specifications, system selection (design considerations, sizing, fittings, valves) and installation.

Our PVC and CPVC piping offers the unique combination of light weight, flexibility, durability and exceptional corrosion resistance. Substantial savings in both initial installation and ongoing maintenance costs are achieved through the selection and use of these engineered materials.

Only IPEX offers Xirtec[®], a complete system of pipe, valves and fittings engineered and manufactured to IPEX's strict quality, performance and dimensional standards.

Xirtec[®] (PVC) and Corzan[®] (CPVC) high performance systems feature outstanding resistance to photodegradation, creep stress and immunity to oxidation, and are exceptionally suited for use with a wide range of acid, alcohols, salts and halogens.

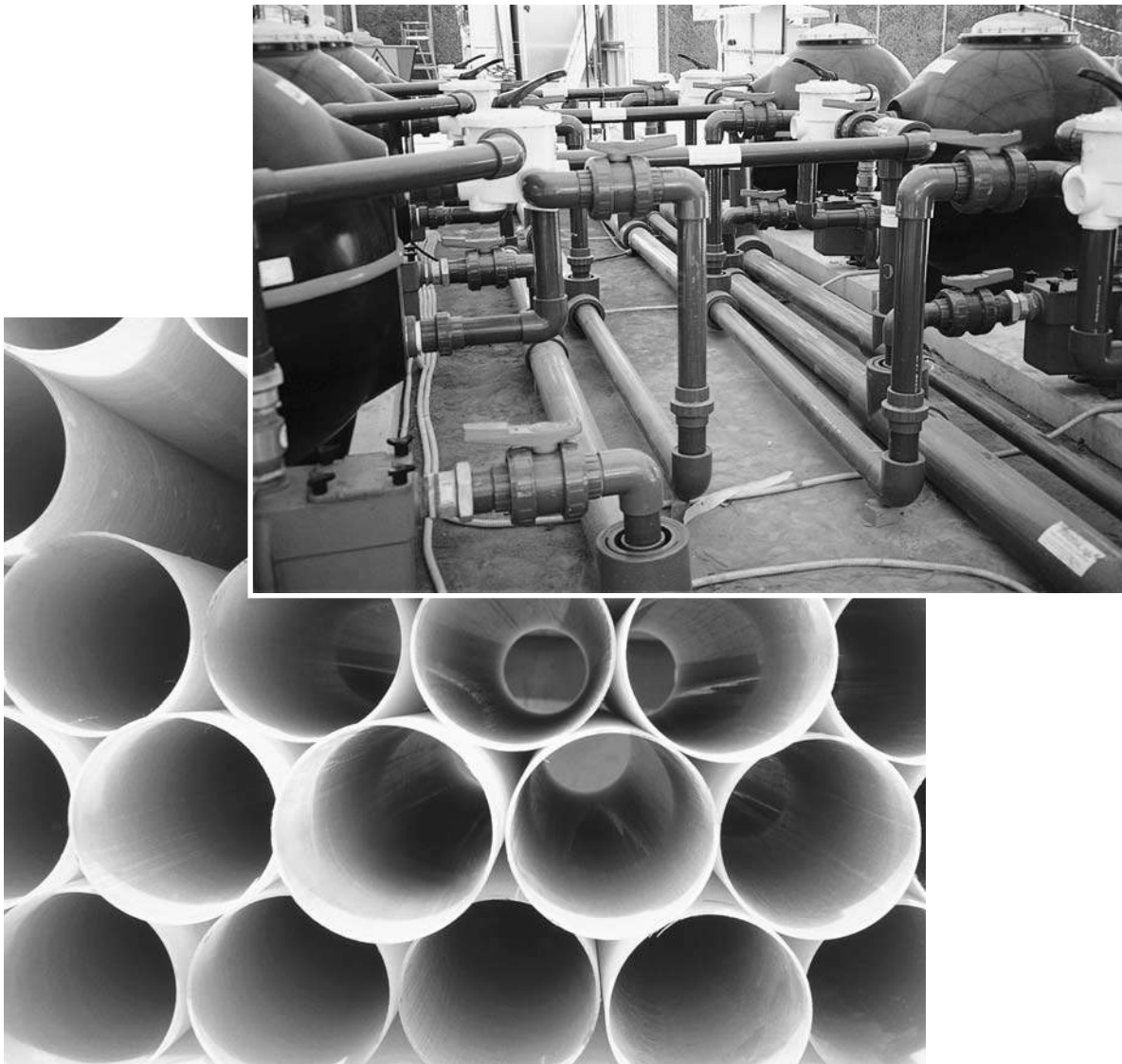

BENEFITS

Lower Installation Costs

In addition to lower material costs than traditional piping materials, vinyl pipe can significantly reduce labor and transportation costs on a typical installation.

Vinyl material is light weight, non-toxic and relatively flexible. Vinyl pipe is easily handled, stored and cut and can be joined in a variety of ways, adapting easily to any field application. Special handling or heavy equipment for installation is not required.

Extended Life

Once properly selected for the application and correctly installed, PVC and CPVC products provide years of maintenance free service. Our materials will not rust, pit, scale or corrode on either interior or exterior surfaces. In fact, thermoplastic piping systems in a variety of demanding industrial applications have operated successfully for over 45 years.

Chemical Resistance

IPEX offers complete systems including pipe, fittings and valves with outstanding resistance to a wide range of chemicals including most acids, alcohols, alkalis, salt solutions and halogens. PVC and CPVC are also not adversely affected by atmospheric conditions and are well suited for outdoor installations. For specific applications see the IPEX Chemical Resistance Guide.

Corrosion Resistance

Our thermoplastic materials are immune to damage from naturally corrosive soil conditions as well as electrochemical or galvanic corrosion. This is particularly advantageous in underground installations where galvanic reaction often causes damage to metal piping products. Our thermoplastic's non-corroding properties ensure improved flow, lower maintenance costs and longer performance life.

Abrasion Resistance

The blending of PVC and CPVC resins, lubricants, modifiers and assorted additives in today's compounds, together with modern extrusion processes, result in a resilient piping product with outstanding abrasion resistance.

PVC and CPVC are often selected as the piping material for conveyance in abrasive service. The inherent abrasion resistance of vinyl allows substantial increases in life expectancy compared to other materials. In many applications, vinyls outperform other materials such as metals.

For example, installation of vinyl piping rather than the standard metal or rubber-lined steel pipe for conveyance of mining and sand slurries resulted in significantly less abrasion, dramatically reduced maintenance and increased system life.

Improved Flow

IPEX piping has a substantially lower Roughness Factor than metal and other materials, and since thermoplastics do not rust, pit, scale or corrode, the interior walls remain smooth in virtually any service. This high carrying capacity may result in the use of flatter grades or smaller diameter pipe.

Non-toxicity

Polyvinyl chloride (PVC) and chlorinated polyvinyl chloride (CPVC) are relatively inert and are suitable for use with potable water as listed with the National Sanitation Foundation (NSF) and Canadian Standards Association (CSA).

Biological Resistance

PVC and CPVC piping systems are resistant to fungi and bacterial growth, particularly those which cause corrosion in metal piping systems.

Service Temperature

IPEX offers a variety of thermoplastic materials designed to meet a broad range of service temperatures. PVC has a recommended maximum service temperature of 140°F (60°C) while CPVC has a maximum service temperature of 200°F (93°C).

Lower Thermal Conductivity

With a dramatically lower thermal conductivity factor as compared to metal, thermoplastic systems have less heat loss or gain, and sustain the temperature of the service with less variation than metal piping. As a result, pipe insulation is often not required.

Fire Performance

PVC and CPVC are self-extinguishing materials. This means that they will not burn unless an external flame source is applied, and will not support combustion once the flame source is removed.

Extensive tests on PVC and CPVC compounds prove their outstanding fire performance. Check local building codes and regulations for specific requirements.

PVC

One of the outstanding characteristics of PVC is its resistance to ignition. This is demonstrated by its flash point (ignition temperature) of 730°F (388°C), compared to 400°F (204°C), for woodchips (white pine).

This is an extremely important characteristic when considering building code restrictions for combustible pipe. Tests performed in accordance to CAN/ULC S102.2 (The

Standard Method of Test for Surface Burning Characteristics of Flooring, Floor Covering and Miscellaneous Materials), show a fuel contribution of 0 for IPEX PVC material.

CPVC

CPVC offers an even greater fire safety profile than PVC. CPVC's ignition resistance is demonstrated by its flash point (ignition temperature) of 900°F (482°C), with a low flame spread as well. In addition, it provides outstanding smoke characteristics. In testing conducted in accordance to CAN/ULC S102.2, IPEX CPVC showed a flame spread of 10, and a smoke-developed classification of 25. And, like PVC, CPVC has a fuel contribution of 0. It does not however meet ASTM E84.

Standards and Approvals

IPEX manufactures the widest range of thermoplastic piping systems available. All products are produced to the strictest internal quality control specifications and meet or exceed applicable regulatory standards.

IPEX will assist customers in obtaining additional product approvals that may be required in a particular jurisdiction.



MATERIAL DESCRIPTION

PVC (Polyvinyl Chloride)

PVC is the most frequently specified of all thermoplastic piping materials. It has been used successfully for over 60 years. PVC is characterized by distinctive physical properties, and is resistant to corrosion and chemical attack by acids, alkalis, salt solutions and many other chemicals. It is attacked, however, by polar solvents such as ketones and aromatics.

Of the various types and grades of PVC used in plastic piping, Type 1, Grade 1 PVC (Cell Classification 12454) conforming to ASTM D1784, is the most common. The maximum service temperature for PVC is 140°F (60°C), under pressure. PVC for drainage applications is also capable of handling near boiling temperatures for intermittent flow conditions. With a hydrostatic design basis of 4000 psi at 73°F (23°C) and a design stress of 2,000 psi at 73°F (23°C), PVC has the highest long-term hydrostatic strength of any other major thermoplastic material used for piping.

CPVC (Chlorinated Polyvinyl Chloride)

CPVC (Cell Classification 24448 and 23447) conforming to ASTM D1784 has physical properties at 73°F (23°C) similar to those of PVC and chemical resistance similar to or generally better than that of PVC. The design stress of CPVC is also 2,000 psi at 73°F (23°C). The maximum service temperature is 200°F (93°C) under pressure with occasional exposure to boiling water (212°F, 100°C). CPVC has proved to be an excellent piping material for hot corrosive liquids, hot and cold water distribution and similar applications above the temperature range of PVC.

Table 1 – Physical Properties

PROPERTIES	MATERIALS			Standards
	PVC	CPVC (Standard)	Corzan CPVC (High Impact)	
Cell classification	12454	23447	24448	
Specific gravity	1.42	1.50	1.51	ASTM D 792
Tensile strength, psi at 73°F	7,000	7,500	7,320	ASTM D 638
Modulus of elasticity tensile, psi at 73°F	400,000	380,000	423,000	ASTM D 638
Flexural strength, psi	14,500	11,400	13,200	ASTM D 790
Izod impact, ft.lbs./in. at 73°F, notched	0.65	2.0	10.0	ASTM D 256
Compressive strength, psi	9,000	10,100	10,100	ASTM D 695
Poisson's ratio	0.38	0.33	0.33	
Working stress, psi at 73°F	2,000	2,000	2,000	
Coefficient of thermal expansion in./in./°F (x 10 ⁻⁵)	3.0	3.8	3.4	ASTM D 696
Linear expansion, in./10°F per 100' of pipe	0.36	0.44 - 0.46	0.41	
Maximum operating temperature under pressure	140°F (60°C)	200°F (93°C)	200°F (93°C)	
Deflection temperature under load, °F at 66 psi	173	n/a	n/a	ASTM D 648
Deflection temperature under load, °F at 264 psi	160	212	239	ASTM D 648
Thermal conductivity, BTU.in./hr.ft ² .°F	1.2	0.95	0.95	ASTM C177
Burning rate	Self extinguish	Self extinguish	Self extinguish	ASTM D 635
Burning class	V-0	V-0	V-0	UL-94
Flash ignition, °F	730	900	900	
Limited oxygen index (%)	43	60	60	ASTM D 2863-70
Water absorption, %, (24 hrs. at 73°F)	0.05	0.03	0.03	ASTM D 570

* The properties listed in this table represent general material properties and should be used as a guideline only.

APPLICATIONS



Industrial and Process Piping

- Plant Water Supply and Distribution Lines
- Cooling Water Systems
- Chemical and Washwater Systems for Photographic Laboratories
- Acid Products Handling for Refineries, Metal Works and Plating Plants
- Bleach, Dye and Acid Lines in Textile Mills
- Deionized Water
- Tailing and Slurry Lines in Mines, Smelters and Fertilizer Plants
- Vacuum Piping
- Pure Chemicals for Semiconductor & Pharmaceutical Industries
- Piping in Fish Hatcheries, Aquariums, Zoological and Biological Buildings
- Well Casings and Dewatering Lines
- Drainage and Effluent Piping
- Swimming Pool Piping
- Rainwater Leaders for Buildings

Pulp and Paper

- Pulp/Chemical Recovery Systems
- Bleach Plant Piping Systems
- Washwater Piping and Lagoon Systems

Food Processing

- Brine and Seawater Distribution in Fish Plants
- Brine Systems in Meat Packaging Plants
- Piping for the Dairy, Canning and Beverage Industries

Water and Sewage Treatment

- Alum and Ferric Chloride Handling
- Chlorine Injection Systems
- Piping in Lagoons and Settling Ponds
- Rainwater Lines

Irrigation

- Golf Courses
- Greenhouses
- Agriculture
- Residential Turf
- Commercial Turf

NOTES

SECTION TWO: PROCESS AND DRAINAGE PIPING DESIGN

INTRODUCTION

Thermoplastics are engineered materials that are suitable for a wide variety of piping assignments in both process and drainage applications. To effectively implement the use of thermoplastics, it is considered necessary to have both a working knowledge of piping design and an appreciation of the unique properties of thermoplastics.

This section will review the design process and consider the most important factors in designing thermoplastic piping systems.

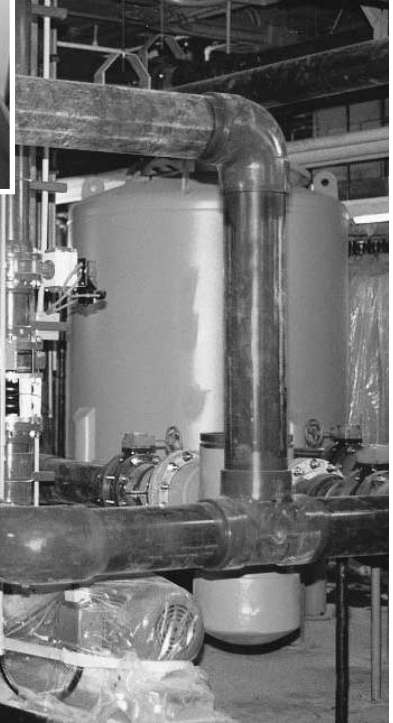

DESIGN PROCESS

Establish System Requirements

Before the proper materials can be chosen, the system requirements must be determined. This establishes the scope of the project and determines design and material specifications. Factors to be considered may include:

1. Liquid composition
 - Chemical characteristics
 - Variations in fluid chemistry
2. Process flow
 - Required flow rate
 - Required pressure
 - Changes in velocity
 - Potential pressure drops
 - Potential pressure surges
 - Minimum and maximum operating temperatures
3. System Location / Environment
 - Above / below ground or overhead
 - Climate (extreme heat or cold)
 - Expected fluctuations in ambient temperature
4. Installation
 - Space restrictions
 - Difficult access
 - New or retrofit
 - Joining of dissimilar materials
5. Budget Considerations
 - Material cost
 - Installation cost
 - Maintenance cost
 - Life expectancy

Determine Appropriate Sizing

In addition to accounting for specific system parameters, pipe size must also be determined. To select an appropriate size, it is essential that there is an understanding of the most important physical factors affecting thermoplastic pipe, which are:

- Pressure limitations
- Temperature limitations
- The pressure/temperature relationship

A) Pressure Limitations

Pressure Ratings

PVC and CPVC pipe are primarily designed to withstand internal pressure under continuous or steady state loading. Short-term higher pressure surges can be accommodated to varying degrees, but it is the long-term strength of the material that determines its performance.

In North America, PVC and CPVC pipe designed for pressure applications must have a defined minimum hydrostatic design basis (HDB) of 4000 psi (27.58 MPa) as per ASTM D 2837. To ensure useful long-term service (minimum of 50 years) a design or safety factor is applied to provide an adequate safety margin. A safety factor of 2 is usually applied.

$$\text{Safety Factor} = \frac{1}{\text{Design Factor}}$$

$$\text{SF} = \frac{1}{\text{DF}}$$

Determining Pressure

The carrying capacity of any pipe is a function of its hoop strength and the geometry of the pipe as defined by its wall thickness and diameter at a given temperature.

Design Stress

The largest stress present in any piping system under pressure is hoop or circumferential stress. This is the governing factor in determining the pressure that a section of pipe can withstand. In calculating pressure, design stress (S) serves as the maximum hoop stress.

$$S = \frac{\text{HDB}}{f}$$

Where:

HDB = hydrostatic design basis
f = safety factor

Example 1:

What would be the hoop stress for a hydrostatic design basis of 4000 psi?

$$S = \frac{4000}{2} \qquad S = 2000 \text{ psi}$$

Known: HDB = 4000, safety factor = f = 2

Wall Thickness

To classify various thicknesses of pipe, the term DR is used. This term refers to the dimension ratio. (See Table 2)

The dimension ratio can also be calculated as follows:

$$DR = D_o/t$$

Where:

- D_o = average outside diameter
- t = minimum wall thickness

Important points to remember about the DR classifications are:

- the lower the DR number, the thicker the pipe wall and the higher the pressure rating
- the pressure capacity and strength of a specific DR is constant regardless of diameter

Note: For schedule pipe, the outside diameter and wall thickness is based on conventional steel pipe dimensions. Therefore, for schedule pipe, each size of vinyl pipe has a different DR rating and a different pressure capability. See Table 2 for values.

Table 2 – Nominal DR Classification for PVC & CPVC Schedule Pipe

Size (in)	Schedule 40			Schedule 80		
	DR	Average OD. (in)	Min. Wall Thickness (in)	DR	Average OD. (in)	Min. Wall Thickness (in)
1/4	-	-	-	4.5	0.540	0.119
3/8	-	-	-	5.4	0.675	0.126
1/2	7.7	0.840	0.109	5.7	0.840	0.147
3/4	9.3	1.050	0.113	6.8	1.050	0.154
1	9.9	1.315	0.133	7.3	1.315	0.179
1 1/4	11.8	1.660	0.141	8.7	1.660	0.191
1 1/2	13.1	1.900	0.145	9.5	1.900	0.200
2	15.4	2.375	0.154	10.9	2.375	0.218
2 1/2	14.2	2.875	0.203	10.4	2.875	0.276
3	16.2	3.500	0.216	11.7	3.500	0.300
4	19.0	4.500	0.237	13.4	4.500	0.337
5	21.6	5.563	0.258	14.8	5.563	0.375
6	23.7	6.625	0.280	15.3	6.625	0.432
8	26.8	8.625	0.322	17.3	8.625	0.500
10	29.5	10.750	0.365	18.1	10.750	0.593
12	31.4	12.750	0.406	18.6	12.750	0.687
14	32.0	14.000	0.438	18.7	14.000	0.750
16	32.0	16.000	0.500	19.0	16.000	0.843
18	32.0	18.000	0.562	19.2	18.000	0.937
20	33.7	20.000	0.593	19.4	20.000	1.031
24	34.9	24.000	0.687	19.7	24.000	1.218

Internal Pressure

The relationships outlined above can be described in an equation, also known as the ISO equation.

$$P = \frac{2S}{DR-1}$$

where:

- P = internal pressure, psi
- S = hoop stress, psi
- DR = dimension ratio (D_o/t)

Example 2:

What would be the maximum pressure allowed for a 2-inch DR 21 pipe?

Known: S = 2000, DR = 21

$$P = \frac{2(2000)}{(21-1)}$$

$$P = \frac{4000}{20}$$

$$P = 200 \text{ psi}$$

Example 3:

What would be the maximum pressure allowed for a 2-inch Schedule 80 pipe?

Step 1: Calculate DR

Known: DR = D_o/t

$$DR = \frac{2.375}{0.218} \text{ (from Table A-14 Dimensions, Weights and Pressure Ratings)}$$

$$DR = 10.9$$

Step 2: Calculate the maximum pressure P

Known: S = 2000, DR = 10.9

$$P = \frac{2(2000)}{(10.9-1)}$$

$$P = \frac{4000}{9.9}$$

$$P = 404 \text{ psi}$$

Example 4:

A piping system consisting of 2 and 4 inch pipe must be capable of sustaining a pressure of 310 psi at ambient temperature (73°F / 23°C). What schedule of pipe is necessary?

Step 1: To calculate actual DR, refer to Table A-14 Dimensions, Weights & Pressure Ratings.

Step 2: For each pipe size and schedule of pipe, first calculate actual DR and then the resulting P.

$$DR = D_o/t$$

$$P = \frac{2S}{DR-1}$$

	Dimension Ratio	Maximum Pressure
2" Schedule 40	DR = $\frac{2.375}{0.154}$ = 15.4	P = $\frac{2(2000)}{(15.4 - 1)}$ = $\frac{4000}{14.4}$ = 278 psi
2" Schedule 80	DR = $\frac{2.375}{0.218}$ = 10.9	P = $\frac{2(2000)}{(10.9 - 1)}$ = $\frac{4000}{9.9}$ = 404 psi
4" Schedule 40	DR = $\frac{4.500}{0.237}$ = 19.0	P = $\frac{2(2000)}{(19.0 - 1)}$ = $\frac{4000}{18.0}$ = 222 psi
4" Schedule 80	DR = $\frac{4.500}{0.337}$ = 13.4	P = $\frac{2(2000)}{(13.4 - 1)}$ = $\frac{4000}{12.4}$ = 323 psi

Therefore, to sustain a pressure of 310 psi, 2" Schedule 80 pipe and 4" schedule 80 pipe are required.

Friction Loss through Piping

As fluid flows through a piping system, it will experience friction resistance between the fluid and the pipe wall resulting in a pressure loss. This pressure loss is a result of fluid:

- density
- viscosity
- velocity
- temperature
- type of flow
- smoothness of the pipe wall

Friction loss can be determined by referring to published tables, such as those in Tables 4, 5, 6, and 7 or it can be calculated. The most widely used equation to calculate friction loss in pressure systems is the Hazen-Williams equation.

Hazen-Williams Equation

$$f = 0.2083 \times \left(\frac{100}{C}\right)^{1.852} \times \frac{Q^{1.852}}{D_i^{4.8655}}$$

where:

- f = friction loss (ft. of H₂O/100 ft.)
- Q = flow rate (gpm)
- D_i = pipe inside diameter (in.)
- C = flow coefficient

Table 3 – Flow Coefficient Constants (C)

Type of Pipe	Flow coefficient C
Vinyl	150
Copper	140
Cast iron - unlined	90 - 120
Galvanized steel	110
Corrugated steel pipe	60

Example 5

A PVC system has a flow rate of 4000 U.S. gallons per minute. What is the friction loss in 20" Schedule 40 pipe?

- Known: Q = 4000 US gpm
 C = 150 (from Table 3 Flow coefficient constants)
 D_i = 18.743 (from Table A-14 Dimensions, Weights & Pressure Ratings)

$$f = 0.2083 \times \left(\frac{100}{150}\right)^{1.852} \times \frac{(4000)^{1.852}}{(18.743)^{4.8655}}$$

$$f = 0.2083 \times 0.476 \times 3.006$$

$$f = 0.3 \text{ ft. per } 100 \text{ ft.}$$

The most widely used equation to calculate friction loss for open channel flow, such as in drainage applications is the Manning formula. Please refer to the section on Drainage.

Note: conversion tip (1 psi = 2.31ft of H₂O)

Table 4 – Carrying Capacity and Friction Loss for Schedule 40 Thermoplastic Pipe

GPM	cu ft/sec	1/2"			3/4"			1"			1 1/4"			1 1/2"			2"			2 1/2"			3"		
		Velocity (ft/s)	Friction Head Loss (ft water/100ft)	Friction Pressure (psf/100ft)	Velocity (ft/s)	Friction Head Loss (ft water/100ft)	Friction Pressure (psf/100ft)	Velocity (ft/s)	Friction Head Loss (ft water/100ft)	Friction Pressure (psf/100ft)	Velocity (ft/s)	Friction Head Loss (ft water/100ft)	Friction Pressure (psf/100ft)	Velocity (ft/s)	Friction Head Loss (ft water/100ft)	Friction Pressure (psf/100ft)	Velocity (ft/s)	Friction Head Loss (ft water/100ft)	Friction Pressure (psf/100ft)	Velocity (ft/s)	Friction Head Loss (ft water/100ft)	Friction Pressure (psf/100ft)	Velocity (ft/s)	Friction Head Loss (ft water/100ft)	Friction Pressure (psf/100ft)
1	0.002	1.13	4.16	0.50	1.26	1.03	0.44	1.93	1.69	0.73	1.10	0.43	0.19	0.38	0.16	0.98	0.21	0.09	1.03	0.19	0.08	1.10	0.17	0.07	
2	0.004	2.26	8.31	1.81	3.16	5.60	2.42	2.70	3.14	1.36	1.55	0.81	0.35	0.73	0.32	1.46	0.45	0.20	1.71	0.49	0.14	1.32	0.24	0.10	
5	0.011	5.64	22.88	9.90	4.43	10.44	4.52	3.86	6.08	2.63	2.21	1.57	0.68	1.62	0.81	1.95	0.77	0.33	1.37	0.33	0.14	1.71	0.49	0.14	
7	0.016	7.89	42.66	18.47	6.32	20.21	8.75	4.63	8.53	3.69	2.65	2.20	0.95	1.94	1.03	2.44	1.17	0.33	1.71	0.49	0.14	1.71	0.49	0.14	
10	0.022	10.027	28.33	12.26	7.59	28.33	12.26	5.79	12.89	5.58	3.31	3.32	1.44	2.42	1.55	3.23	1.64	0.71	2.05	0.69	0.30	1.71	0.49	0.14	
12	0.027	12.027	42.82	18.54	9.48	42.82	18.54	7.72	21.96	9.51	4.42	5.65	2.45	3.23	2.64	4.11	2.18	0.94	2.29	1.18	0.51	1.77	0.41	0.18	
15	0.033	15.033						9.65	33.20	14.37	5.52	8.55	3.70	4.04	4.00	4.13	3.47	1.50	3.08	1.46	0.63	1.99	0.51	0.22	
20	0.045	20.045						11.58	46.54	20.15	6.63	11.98	5.19	4.85	5.60	4.22	4.88	2.18	3.42	1.78	0.77	2.21	0.61	0.27	
25	0.056	25.056									8.84	20.41	8.84	6.47	9.54	7.45	5.92	2.56	4.10	2.49	1.08	2.65	0.86	0.37	
30	0.067	30.067									9.94	25.39	10.99	7.27	11.87	5.14	6.34	2.97	4.44	2.89	1.25	2.87	1.00	0.43	
35	0.078	35.078									11.05	30.86	13.36	8.08	14.43	6.25	7.87	3.41	4.79	3.32	1.44	3.09	1.15	0.50	
40	0.089	40.089												8.89	17.21	7.45	8.94	3.87	5.13	3.77	1.63	3.31	1.30	0.56	
45	0.100	45.100												9.70	20.22	8.75	10.51	4.36	5.47	4.25	1.84	3.53	1.47	0.63	
50	0.111	50.111												10.51	23.45	10.15	11.32	4.82	5.81	4.75	2.06	3.75	1.64	0.71	
55	0.123	55.123												11.32	26.90	11.65		5.28	6.15	5.28	2.29	3.97	1.82	0.79	
60	0.134	60.134																5.43	6.49	5.84	2.53	4.20	2.02	0.87	
65	0.145	65.145																6.00	6.84	6.42	2.78	4.42	2.22	0.96	
70	0.156	70.156																6.59	7.27	6.84	3.02	4.62	2.42	1.05	
75	0.167	75.167																	7.80	8.29	7.84	3.31	3.30	2.62	1.14
80	0.178	80.178																	8.29	8.78	8.29	3.53	3.53	2.82	1.23
85	0.189	85.189																	9.27	9.27	8.78	3.75	3.75	3.03	1.32
90	0.201	90.201																	9.75	9.75	9.27	3.97	3.97	3.24	1.41
100	0.223	100.223																	10.26	10.26	9.75	4.20	4.20	3.46	1.50
125	0.279	125.279																							1.82
150	0.334	150.334																							2.12
175	0.390	175.390																							2.42
200	0.446	200.446																							2.72
250	0.557	250.557																							3.35
300	0.668	300.668																							4.06
350	0.780	350.780																							4.77
400	0.891	400.891																							5.48
450	1.003	450.1003																							6.19
500	1.114	500.1114																							6.90
600	1.337	600.1337																							8.31
700	1.560	700.1560																							9.72
800	1.782	800.1782																							11.13
900	2.005	900.2005																							12.54
1000	2.228	1000.2228																							13.95
1250	2.785	1250.2785																							16.76
1500	3.342	1500.3342																							19.57
2000	4.456	2000.4456																							25.38
2500	5.570	2500.5570																							31.19
3000	6.684	3000.6684																							37.00
3500	7.798	3500.7798																							42.81
4000	8.912	4000.8912																							48.62
4500	10.026	4500.10026																							54.43
5000	11.140	5000.11140																							60.24
5500	12.254	5500.12254																							66.05
6000	13.368	6000.13368																							71.86
6500	14.482	6500.14482																							77.67
7000	15.596	7000.15596																							83.48
7500	16.710	7500.16710																							89.29
8000	17.824	8000.17824																							95.10
8500	18.938	8500.18938																							100.91
9000	20.052	9000.20052																							106.72
9500	21.166	9500.21166																							112.53
10000	22.280	10000.22280																							118.34

CAUTION: Flow velocity should not exceed 5 feet per second.

Table 5 – Carrying Capacity and Friction Loss for Schedule 80 Thermoplastic Pipe

GPM	cu ft/sec	1/2"			3/4"			1"			1 1/4"			1 1/2"			2"			2 1/2"			3"		
		Velocity (ft/s)	Friction Head Loss (ft water/100ft)	Friction Pressure (psi/100ft)	Velocity (ft/s)	Friction Head Loss (ft water/100ft)	Friction Pressure (psi/100ft)	Velocity (ft/s)	Friction Head Loss (ft water/100ft)	Friction Pressure (psi/100ft)	Velocity (ft/s)	Friction Head Loss (ft water/100ft)	Friction Pressure (psi/100ft)	Velocity (ft/s)	Friction Head Loss (ft water/100ft)	Friction Pressure (psi/100ft)	Velocity (ft/s)	Friction Head Loss (ft water/100ft)	Friction Pressure (psi/100ft)	Velocity (ft/s)	Friction Head Loss (ft water/100ft)	Friction Pressure (psi/100ft)	Velocity (ft/s)	Friction Head Loss (ft water/100ft)	Friction Pressure (psi/100ft)
1	0.002	1.48	2.24	0.97	1.73	0.75	0.21	1.30	0.64	0.28	1.31	0.54	0.24	1.68	0.63	0.27	2.23	1.07	0.47	1.56	0.45	0.19	2.23	1.07	0.47
2	0.004	2.95	8.10	3.51	3.92	4.10	1.16	1.82	2.32	0.52	1.88	1.05	0.46	2.23	1.31	0.54	2.79	1.63	0.70	1.95	0.68	0.29	2.79	1.63	0.70
5	0.011	7.39	44.21	19.14	5.49	17.65	7.64	3.27	4.98	2.16	4.67	3.27	2.16	5.60	3.11	1.40	8.85	4.91	2.12	5.63	2.28	0.99	8.85	4.91	2.12
7	0.016	10.34	82.43	35.69	7.84	34.18	14.79	4.67	9.65	4.18	5.60	3.52	5.85	7.00	2.04	11.66	6.49	2.64	7.71	3.48	1.08	11.66	6.49	2.64	
10	0.022				9.41	47.90	20.74	5.60	13.52	5.85	7.00	3.52	5.85	9.33	34.82	15.07	8.36	8.36	3.62	8.36	3.62	1.21	9.33	34.82	15.07
12	0.027				11.76	72.42	31.35	6.49	12.64	5.47	6.49	3.62	5.47	10.38	30.17	13.06	10.38	10.38	3.06	10.38	3.06	1.08	10.38	30.17	13.06
15	0.033							7.00	17.71	7.67	7.00	3.62	7.67	11.32	26.90	11.65	11.32	11.32	2.69	11.32	2.69	1.08	11.32	26.90	11.65
20	0.045							11.66	52.64	22.79				13.06			13.06	13.06	2.09	13.06	2.09	1.08	13.06		
25	0.056																								
30	0.067																								
35	0.078																								
40	0.089																								
45	0.100																								
50	0.111																								
55	0.123																								
60	0.134																								
65	0.145																								
70	0.156																								
75	0.167																								
80	0.178																								
90	0.201																								
100	0.223																								
125	0.279																								
150	0.334																								
175	0.390																								
200	0.446																								
250	0.557																								
300	0.668																								
350	0.780																								
400	0.891																								
450	1.003																								
500	1.114																								
600	1.337																								
700	1.560																								
800	1.782																								
900	2.005																								
1000	2.228																								
1250	2.785																								
1500	3.342																								
2000	4.456																								
2500	5.570																								
3000	6.684																								
3500	7.798																								
4000	8.912																								
4500	10.026																								
5000	11.140																								
5500	12.254																								
6000	13.368																								
7000	15.596																								
7500	16.710																								
8000	17.824																								
8500	18.938																								
9000	20.052																								
9500	21.166																								
10000	22.280																								

CAUTION: Flow velocity should not exceed 5 feet per second.

Table 6 – Carrying Capacity and Friction Loss for DR 21 Thermoplastic Pipe

GPM	cu ft/sec	Velocity (ft/s)	Friction Head Loss (ft water/100ft)	Friction Pressure (psi/100ft)	Velocity (ft/s)	Friction Head Loss (ft water/100ft)	Friction Pressure (psi/100ft)	Velocity (ft/s)	Friction Head Loss (ft water/100ft)	Friction Pressure (psi/100ft)	Velocity (ft/s)	Friction Head Loss (ft water/100ft)	Friction Pressure (psi/100ft)	Velocity (ft/s)	Friction Head Loss (ft water/100ft)	Friction Pressure (psi/100ft)	
1	0.002																
2	0.004																
5	0.011	1.88	2.68	1.16	1.08	0.70	0.30										
7	0.016	4.69	14.62	6.33	2.70	3.81	1.65										
10	0.022	6.57	27.27	11.81	3.78	7.11	3.08										
12	0.027	9.38	52.79	22.85	5.40	13.77	5.96										
15	0.033	11.26	74.00	32.03	6.48	19.30	8.35										
20	0.045				8.10	29.17	12.63										
25	0.056				10.80	49.70	21.51										
30	0.067																
35	0.078																
40	0.089																
45	0.100																
50	0.111																
55	0.123																
60	0.134																
65	0.145																
70	0.156																
75	0.167																
80	0.178																
90	0.201																
100	0.223																
125	0.279																
150	0.334																
175	0.390																
200	0.446																
250	0.557																
300	0.668																
350	0.780																
400	0.891																
450	1.003																
500	1.114																
600	1.337																
700	1.560																
800	1.782																
900	2.005																
1000	2.228																
1250	2.785																
1500	3.342																
2000	4.456																
2500	5.570																
3000	6.684																
3500	7.798																
4000	8.912																
4500	10.026																
5000	11.140																
5500	12.254																
6000	13.368																
6500	14.482																
7000	15.596																
7500	16.710																
8000	17.824																
8500	18.938																
9000	20.052																
9500	21.166																
10000	22.280																

CAUTION: Flow velocity should not exceed 5 feet per second.

PROCESS &
DRAINAGE PIPING DESIGN

Table 7 – Carrying Capacity and Friction Loss for DR 26 Thermoplastic Pipe

GPM	cu ft/sec	Velocity (ft/s)	Friction Head Loss (ft water/100ft)	Friction Pressure (psi/100ft)	Velocity (ft/s)	Friction Head Loss (ft water/100ft)	Friction Pressure (psi/100ft)	Velocity (ft/s)	Friction Head Loss (ft water/100ft)	Friction Pressure (psi/100ft)	Velocity (ft/s)	Friction Head Loss (ft water/100ft)	Friction Pressure (psi/100ft)	Velocity (ft/s)	Friction Head Loss (ft water/100ft)	Friction Pressure (psi/100ft)	
1	0.002																
2	0.004																
5	0.011																
7	0.016																
10	0.022																
12	0.027																
15	0.033																
20	0.045																
25	0.056																
30	0.067																
35	0.078																
40	0.089																
45	0.100																
50	0.111																
55	0.123																
60	0.134																
65	0.145																
70	0.156																
75	0.167																
80	0.178																
90	0.201																
100	0.223																
125	0.279																
150	0.334																
175	0.390																
200	0.446																
250	0.557																
300	0.668																
350	0.780																
400	0.891																
450	1.003																
500	1.114																
600	1.337																
700	1.560																
800	1.782																
900	2.005																
1000	2.228																
1250	2.785																
1500	3.342																
2000	4.456																
2500	5.570																
3000	6.684																
3500	7.798																
4000	8.912																
4500	10.026																
5000	11.140																
5500	12.254																
6000	13.368																
6500	14.482																
7000	15.596																
7500	16.710																
8000	17.824																
8500	18.938																
9000	20.052																
9500	21.166																
10000	22.280																

CAUTION: Flow velocity should not exceed 5 feet per second.

Friction Loss through Fittings

Friction head loss also occurs through fittings. To account for friction loss through fittings, the friction loss is estimated in equivalent feet of straight pipe that would produce the same friction loss. Values for friction loss through various fittings are given in Table 8.

**Table 8
Friction Loss through Fittings (Equivalent pipe length in feet)**

Size (in.)	Fittings			
	Tee Run	Tee Branch	90° Elbow	45° Elbow
1/2	1.0	3.8	1.5	0.8
3/4	1.4	4.9	2.0	1.1
1	1.7	6.0	2.5	1.4
1 1/4	2.3	7.3	3.8	1.8
1 1/2	2.7	8.4	4.0	2.1
2	4.0	12.0	5.7	2.6
2 1/2	4.9	14.7	6.9	3.1
3	6.1	16.4	7.9	4.0
4	7.9	22.0	11.4	5.1
6	12.3	32.7	16.7	8.0
8	14.0	49.0	21.0	10.6
10	17.5	57.0	26.0	13.5
12	20.0	67.0	32.0	15.5
14	25.0	78.0	37.0	18.0
16	27.0	88.0	43.0	20.0
18	32.0	107.0	53.0	23.0
20	35.0	118.0	58.0	25.0
24	42.0	137.0	67.0	30.0

Example 6

In this example, Figure 1 shows a diagram of a simple process cooling water system (P1 - P5). The system consists of 3" Schedule 80 PVC pipe with a flow rate of 100 US gpm. What is the total system friction loss due to fittings?

Figure 1 – Schematic of simple system loop

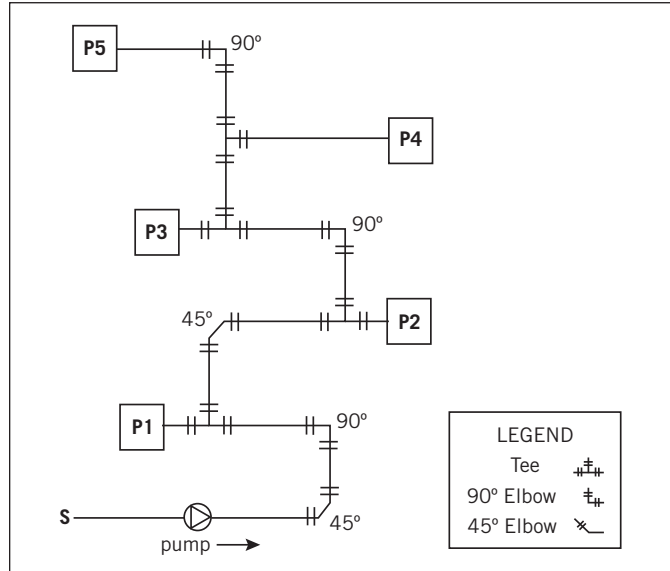

- Step 1: Count the number of fittings by type as you work your way through the system.
- Step 2: Determine the fitting loss by referring to Table 8, Friction Loss through Fittings.
- Step 3: Calculate the friction loss per fitting size and type, then sum for the total system loss due to fittings as per the table below.

Fitting	Type	3"		
		No.	Loss	Total (ft)
Tee	Run	4	6.1	24.4
Tee	Branch	4	16.4	65.6
90°	Elbow	3	7.9	23.7
45°	Elbow	2	4.0	8.0
Total				121.7

To calculate the friction loss in psi, refer to Table 5 (Carrying Capacity and Friction Loss for Schedule 80 Pipe) to determine the friction loss in equivalent pipe for the given flow rate.

$$\frac{\text{friction loss (psi/100 ft)} \times \text{total equivalent length of pipe (psi)}}{100}$$

$$\frac{1.29}{100} \times 121.7 = 1.57 \text{ psi}$$

Therefore, the total friction loss due to fittings is 121.7 ft of pipe or 1.57 psi.

Friction Loss through Valves

Pressure drops through valves also contribute to the overall friction loss of fluid through a piping system. Flow rate coefficients (C_v) are defined as the flow rate in gallons per minute (gpm) through an open valve resulting in a pressure drop of 1 psi. Flow rate coefficients are listed in the Thermoplastic Valve Manual (Volume 7 in the IPEX Industrial Technical Manual series) and can also be calculated using the following formula.

$$f = sg (Q/C_v)^2$$

Where:

f = pressure drop (friction loss) across the valve (psi)

sg = specific gravity (water = 1.0)

Q = flow through the valve (gpm)

C_v = flow rate coefficient

Example 7

In this example, Figure 2 shows a diagram of a simple process cooling water system. The system consists of 3" Schedule 80 PVC pipe with a flow rate of 100 US gpm. What is the total system friction loss through valves?

Figure 2 - Schematic of simple system loop with valves

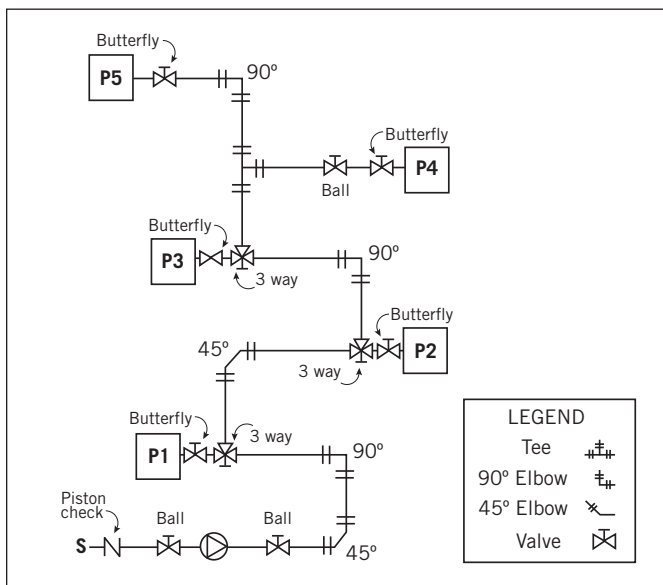

Step 1: Count the number of valves by type as you work your way through the system.

Step 2: Determine the flow rate coefficient by valve type and size by referring to tables in valve specifications (values are given here)

Step 3: Calculate the loss per valve type and then sum for the total system loss due to valves as per the table below.

Known: $C_v = 497$ for 3" VK Ball Valve

$C_v = 248$ for 3" Butterfly Valve

$C_v = 0$ for TK Three Way Ball Valve

$Q = 100$ gpm

Valve Type	No.	Loss	Total (psi)
VR Piston Check	1	$f = 1 \times \left(\frac{100}{206}\right)^2$ $f = 0.24$ psi	0.24
VK Ball	3	$f = 1 \times \left(\frac{100}{497}\right)^2$ $f = 0.04$ psi	0.12
FK Butterfly	5	$f = 1 \times \left(\frac{100}{248}\right)^2$ $f = 0.16$ psi	0.80
TK Three Way Ball	3	$f = 0.16$ psi * similar to 90° elbow	0.48
Total			1.64

The total friction loss due to valves is 1.64 psi.

B) Temperature Limitations

Under pressure, for IPEX Schedule 40 and 80 PVC, the average system operating temperature ranges from 40°F (4°C) to 140°F (60°C). For IPEX Schedule 80 CPVC, the average pressure system operating temperature ranges from 40°F (4°C) to 200°F (93°C). For applications outside these ranges please contact IPEX representatives.

C) Pressure/Temperature Relationship

Thermoplastic material strength is sensitive to temperature. Standard PVC and CPVC pipe pressure ratings are all determined at an ambient temperature of 73°F (23°C). Generally, as the operating temperature falls below the basis temperature of 73°F, there is an increase in hoop strength and a subsequent increase in pressure rating. However, as the operating temperature rises above the basis temperature, strength decreases. In the former, usually no consideration is made to the design process and the incremental strength is considered part of the safety factor. However, compensation should be made for operating temperatures above 73°F (23°C). A temperature correction factor, as shown in Table 9 must be applied to reduce the pressure rating.

Note: The temperature correction factors in Table 9 only apply to pipe and fittings. For adjustments to valve pressure ratings please consult the Thermoplastic Valve Manual (Volume 7 in the IPEX Industrial Technical Manual series) or IPEX representatives.

Example 8

What is the Pressure Rating of 3" Schedule 40 PVC at 100°F?

Step 1: Determine Maximum Working Pressure for 3" Schedule 40 PVC from Appendix A, Table A14 = 260 psi

Step 2: Determine Correction Factor at 100°F for PVC = 0.62

Step 3: Maximum Working Pressure x Correction Factor will give the pressure rating at the elevated system temperature

$$260 \text{ psi} \times 0.62 = 161.20 \text{ psi @ } 100^\circ\text{F}$$

Table 9 – Temperature Correction Factors

Operating Temperature		Correction Factors	
°F	°C	PVC	CPVC
73	23	1.00	1.00
80	27	0.88	0.96
90	32	0.75	0.91
100	38	0.62	0.82
110	43	0.50	0.74
120	49	0.40	0.65
130	54	0.30	0.58
140	60	0.22	0.50
150	66	*	0.45
160	71	*	0.40
170	77	*	0.33
180	82	*	0.25
200	93	NR	0.20
212	100	NR	*

* Recommended for intermittent drainage only
NR – Not Recommended

DESIGN CONSIDERATIONS

Expansion and Contraction

All piping products expand and contract with changes in temperature. Linear expansion and contraction of any pipe on the longitudinal axis relates to the coefficient of thermal expansion (e) for the specific material used in the manufacturing of the product. Variation in pipe length due to thermal expansion or contraction depends on the linear expansion factor (Y) and the variation in temperature irrespective of wall thickness. This means that the factors for schedule 40 and schedule 80 pipe are the same.

Table 10 – Coefficients of Thermal Expansion

Piping Material	e Thermal Exp. Coefficient		Y Linear Exp. Factor	
	in/in/°F	cm/cm/°C	in/10°F/100' of pipe	mm/5°C/10m of pipe
PVC	3.0 x 10 ⁻⁵	5.4 x 10 ⁻⁵	0.360	2.70
CPVC	3.8 x 10 ⁻⁵	6.8 x 10 ⁻⁵	0.456	3.40

The length change due to thermal expansion or contraction depends on the system temperature differential, as well as the length of pipe run between changes in direction. Values for thermal expansion for both PVC and CPVC pipe are given in Tables 11 and 12. Expansion can also be calculated using the following formula:

$$\Delta L = \frac{Y (T - F)}{10} \times \frac{L}{100}$$

where:

- ΔL = change in length (in.)
- Y = linear expansion factor (inches of expansion per 10°F temperature change per 100 ft. of pipe)
- T = maximum temperature (°F)
- F = minimum temperature (°F)
- L = length of pipe run (ft)

When total temperature change is less than 30°F (17°C), provisions for thermal expansion are not generally required, especially when the line includes several directional changes as there is considerable inherent flexibility in the piping system.

Caution

Caution should be exercised with threaded connections, as they are more vulnerable to bending stresses created by expansion forces. Where such conditions exist, it is advisable to use a flanged connection.

Note: Remember to allow for contraction when piping is to be exposed to temperatures substantially below installation temperature.

Example 9

How much linear expansion can be expected in a 215 foot straight run of 3" diameter Schedule 40 PVC pipe installed at 75°F and operating at 135°F?

Known: L = 215, T = 135, F = 75, Y = 0.36 (from Table 10, Coefficients of Thermal Expansion)

$$\Delta L = Y \times \frac{(T - F)}{10} \times \frac{L}{100}$$

$$\Delta L = 0.36 \times \frac{(135 - 75)}{10} \times \frac{215}{100}$$

$$= 0.36 \times 6 \times 2.15$$

$$= 4.6 \text{ in.}$$

Table 11 – PVC Linear Expansion (ΔL) in inches

Temp. change ΔT (°F)	Length of Run (ft)									
	10	20	30	40	50	60	70	80	90	100
10	0.04	0.07	0.11	0.14	0.18	0.22	0.25	0.29	0.32	0.36
20	0.07	0.14	0.22	0.29	0.36	0.43	0.50	0.58	0.65	0.72
30	0.11	0.22	0.32	0.43	0.54	0.65	0.76	0.86	0.97	1.08
40	0.14	0.29	0.43	0.58	0.72	0.86	1.01	1.15	1.30	1.44
50	0.18	0.36	0.54	0.72	0.90	1.08	1.26	1.44	1.62	1.80
60	0.22	0.43	0.65	0.86	1.08	1.30	1.51	1.73	1.94	2.16
70	0.25	0.50	0.76	1.01	1.26	1.51	1.76	2.02	2.27	2.52
80	0.29	0.58	0.86	1.15	1.44	1.73	2.02	2.30	2.59	2.88
90	0.32	0.65	0.97	1.30	1.62	1.94	2.27	2.59	2.92	3.24
100	0.36	0.72	1.08	1.44	1.80	2.16	2.52	2.88	3.24	3.60

Table 12 – CPVC Thermal Expansion (ΔL) in inches

Temp. change ΔT (°F)	Length of Run (ft)									
	10	20	30	40	50	60	70	80	90	100
10	0.05	0.09	0.14	0.18	0.23	0.27	0.32	0.36	0.41	0.46
20	0.09	0.18	0.27	0.36	0.46	0.55	0.64	0.73	0.82	0.91
30	0.14	0.27	0.41	0.55	0.68	0.82	0.96	1.09	1.23	1.37
40	0.18	0.36	0.55	0.73	0.91	1.09	1.28	1.46	1.64	1.82
50	0.23	0.46	0.68	0.91	1.14	1.37	1.60	1.82	2.05	2.28
60	0.27	0.55	0.82	1.09	1.37	1.64	1.92	2.19	2.46	2.74
70	0.32	0.64	0.96	1.28	1.60	1.92	2.23	2.55	2.87	3.19
80	0.36	0.73	1.09	1.46	1.82	2.19	2.55	2.92	3.28	3.65
90	0.41	0.82	1.23	1.64	2.05	2.46	2.87	3.28	3.69	4.10
100	0.46	0.91	1.37	1.82	2.28	2.74	3.19	3.65	4.10	4.56

Offsets and Directional Changes

A common solution to the problem of thermal expansion/contraction is to absorb the change in length by building in flexibility into the system. This can be accomplished by introducing changes of direction, offsets and expansion loops. Expansion joints may also be used, particularly in situations where it is not possible to configure added flexibility. The various pipe configurations are shown in Figure 3.

Figure 3 - Pipe Configurations for Expansion/Contraction

Directional Change

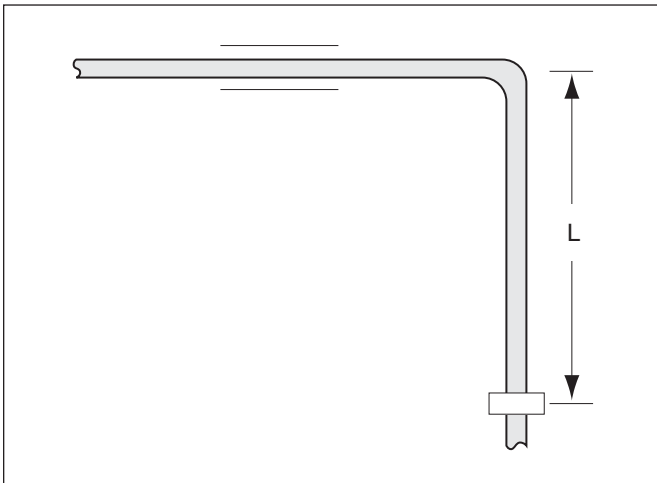

Offset

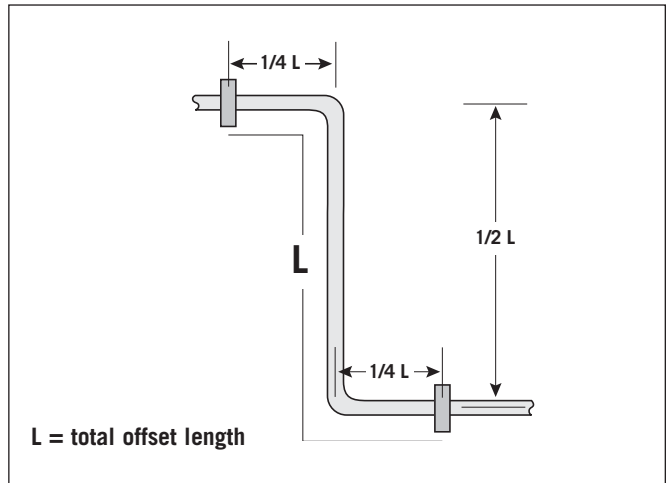

Expansion Loop

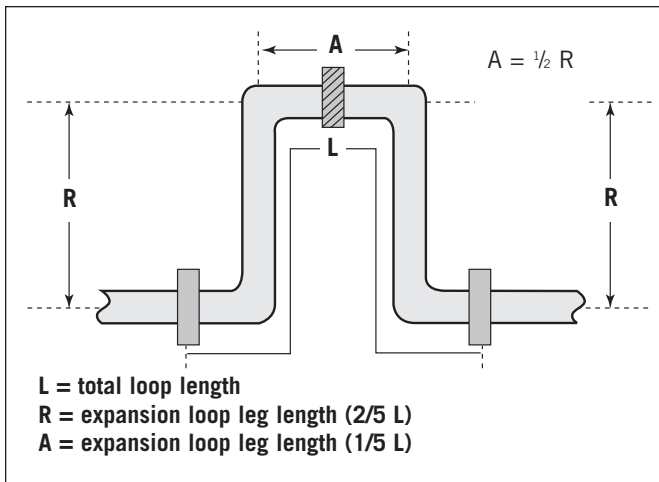

Expansion Joint

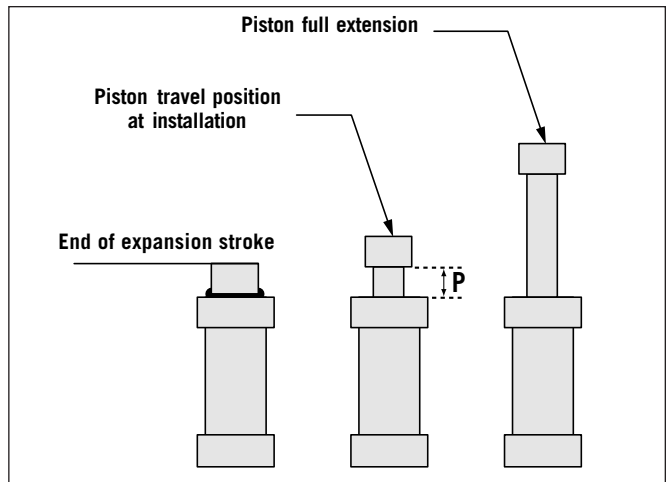

Expansion Loops

Normally, piping systems are designed with enough directional changes so that the system will compensate for expansion and contraction. However, when this is not the case or when there is reasonable doubt as to the flexibility of the system, expansion loops or expansion joints should be incorporated into the system. It is recommended that expansion loops and offsets should be constructed with 90° elbows and straight pipe that are solvent cemented together in order to handle the stresses during expansion more effectively. A typical expansion loop is shown in Figure 4.

Figure 4 - Typical Expansion Loop

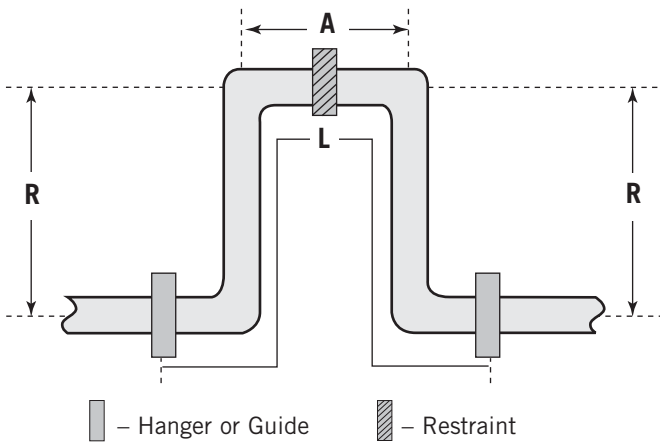

Table 13 - Working Stress at Elevated Temperatures (psi)

Temperature		PVC		CPVC	
		Modulus of Elasticity	Working Stress	Modulus of Elasticity	Working Stress
73	23	400,000	2000	423,000	2000
90	32	372,000	1500	403,000	1820
110	43	336,000	1000	371,000	1480
140	60	280,000	440	323,000	1000
160	71	-	-	291,000	750
180	82	-	-	269,000	500
200	93	-	-	220,000	400

To ensure that the loop is of sufficient length to absorb expansion and contraction movement without damage, the following modified beam deflection equation can be used.

$$L = \sqrt{\frac{3ED(\Delta I)}{S}}$$

where:

- L = total expansion loop length (in)
- E = modulus of elasticity at maximum operating temperature (psi)
- S = working stress at maximum operating temperature (psi)
- D = nominal outside diameter of pipe (in)
- ΔI = change in length due to thermal expansion or contraction (in)
- R = expansion loop leg length ($\frac{2}{5} L$)
- A = expansion loop leg length ($\frac{1}{5} L$)

Example 10

For a run of 100 ft of 3" Sch 80 PVC, installed at 65°F and operating at 140°F, how long should the expansion loop legs be in order to compensate for the expansion?

Step 1: Calculate the amount of expansion to be expected.

$$\Delta I = Y \times \frac{(T - F)}{10} \times \frac{L}{100}$$

Known: L = 100 ft, T = 140°F, F = 65°F,
Y = 0.36 in/100ft/10°F (from Table 10, Coefficients of Thermal Expansion)

$$\Delta I = 0.36 \times \frac{(140 - 65)}{10} \times \frac{100}{100}$$

$$\Delta I = 2.7 \text{ in.}$$

Step 2: Calculate the expansion loop length.

$$L = \sqrt{\frac{3ED(\Delta I)}{S}}$$

Known: ΔI = 2.7 in., E = 280,000 psi (from Table 13 - Working Stress at Elevated Temperatures),
S = 1000 psi (from Table 13), D = 3.5 in (from Table A-14 - Dimensions, Weights & Pressure Ratings)

$$L = \sqrt{\frac{3 \times 280000 \times 3.5 \times 2.7}{440}}$$

$$L = 134 \text{ inches} \quad R = \frac{2}{5} L = 54 \text{ inches} \quad A = \frac{1}{5} L = 27 \text{ inches}$$

Therefore the total expansion loop length is 134 inches, the expansion loop leg length R is 54 inches and the expansion loop leg length A is 27 inches.

Expansion Joints

Expansion joints are particularly desirable for large diameter pipe or where space for offset lines is limited. An expansion joint consists of two cylinders, one telescoping inside the other. The outer cylinder is firmly anchored while the inner cylinder is allowed to move with a piston-like action as the attached pipe expands or contracts. IPEX manufactures the Telescopic Expansion Device (T.E.D.), a cost effective solution designed to relieve stress in a piping system.

In long runs of 150 feet or more, the pipeline should be anchored at each change of direction so that expansion movement of the pipe will be directed squarely into the expansion joint. Alignment of expansion joints is most important. Binding can result if the pipe is canted or cocked and does not move in the same plane as the joint. Guide loops should be installed approximately one foot from the end of each expansion joint.

Beyond the required system guides, the IPEX T.E.D. further incorporates a special self-aligning design. A wide piston guide is fitted inside the device to prevent skewing and consequent binding. To further enhance the self-aligning property of T.E.D. a triple o-ring seal is added. This combination produces higher performance reducing the chances of leaks and/or premature failure due to misalignment, thus effectively increasing the life expectancy of your entire system.

Configurations using expansion joints

Example A illustrates a long pipe run, anchored at each end, which requires absorption of thermal expansion. Calculations have determined that a single device can be used with intermediate pipe guides. It is recommended that the device be located as close as possible to the anchor at the end of the run (based on flow direction). The first guide should be installed in the proximity of the connection between the pipe and the receiver on the moving arm of the T.E.D. unit. This will ensure that the deflection is limited to the expected axial direction. The second guide is located relatively close to the first to avoid bowing of the pipe. Additional guides, evenly spaced, will be installed as needed.

Example A

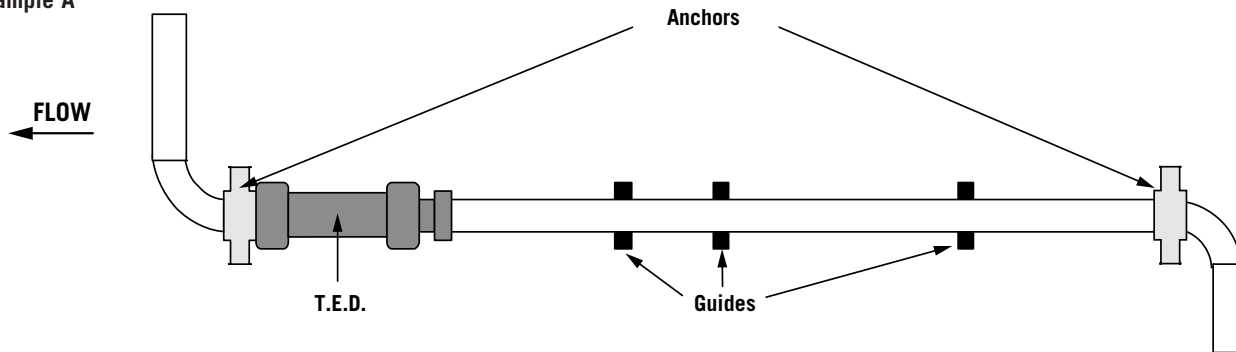

Example B illustrates an even longer pipe run. Calculations have determined that two devices must be employed. As a result, the run has been divided into two equal segments by a median anchoring point. A T.E.D. unit is positioned at each end of the previously separated runs. Guide placement is consistent with the outlines in Example A.

Example B

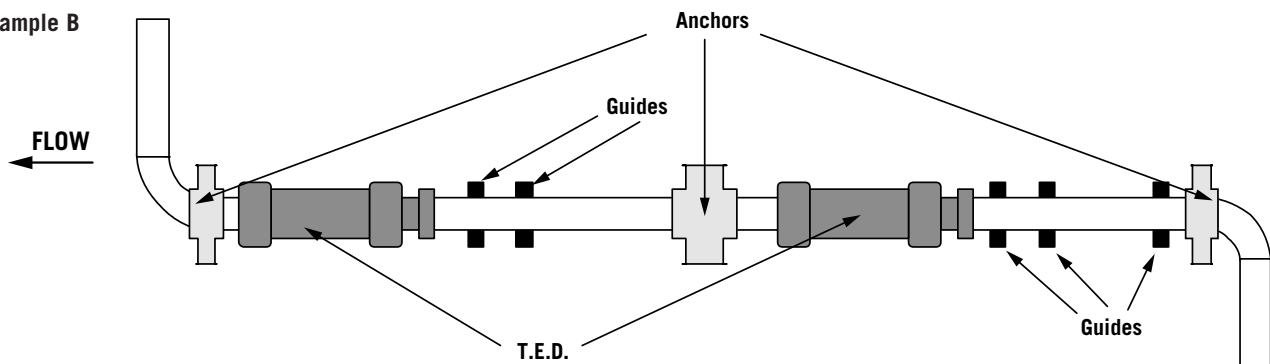

Example C illustrates a long run in which a larger diameter pipe is reduced to a smaller diameter near the middle of the run. Although the amount of expansion in thermoplastic is not a function of the pipe diameter, should it be determined that two separate devices are needed, it is good practice to subdivide the run with an anchor at the transition point. Subsequently identical procedures to those in Example B are to be followed.

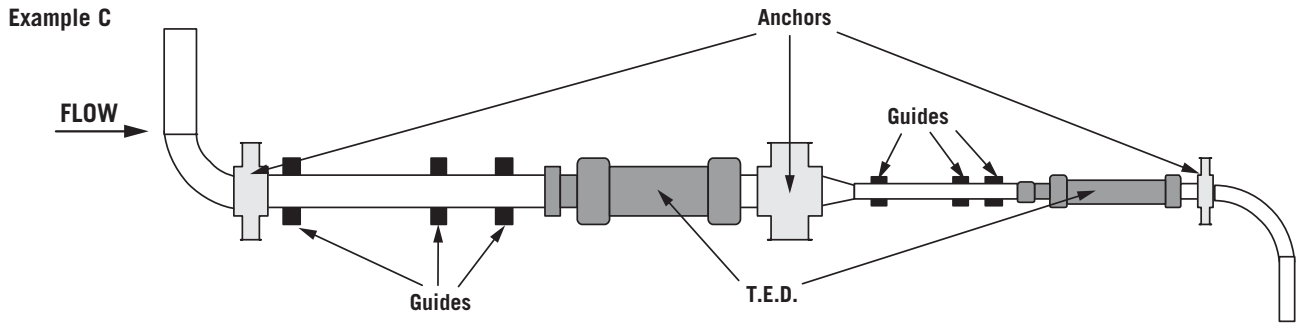

Example D illustrates the branching of a long run. For the main pipe section an identical arrangement to that of Example B is used, however a main anchor must be used at the TEE rather than the intermediate anchor. The main anchor is designed to resist the pressure thrust of the branch line. In the direction of the main line the anchor must also resist any dynamic pressure thrust imbalance that results from the turbulence caused by the branch line. Should the run in the branch line require it, a T.E.D. unit will be installed following the procedure in Example A.

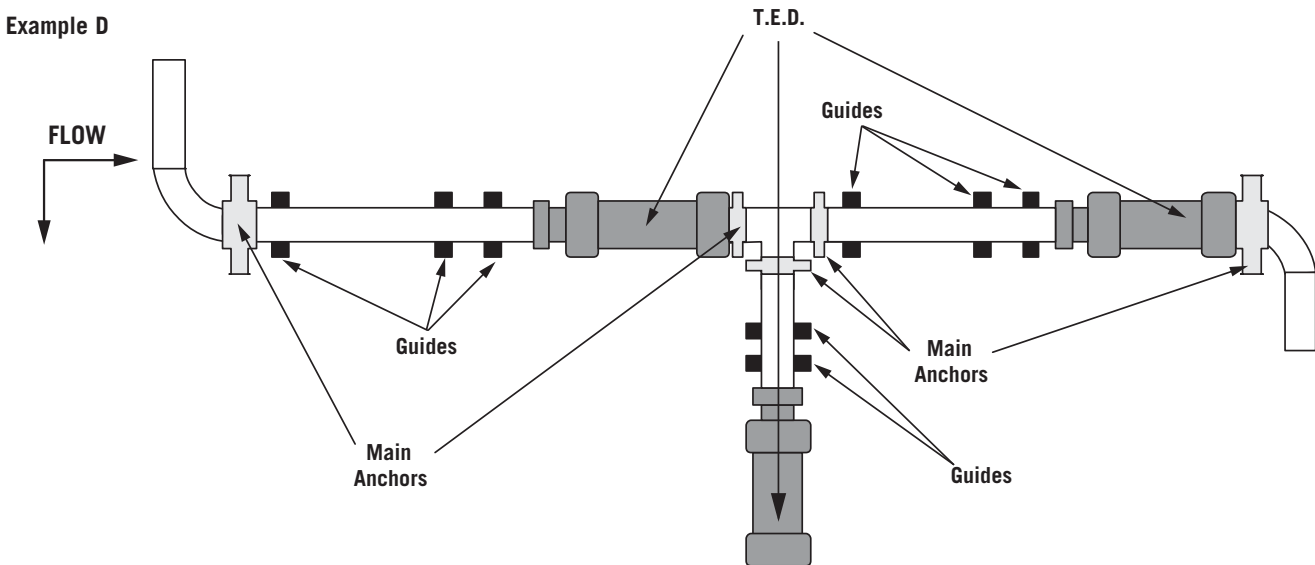

T.E.D. Installation Procedure

Common sense will dictate that if the piston is expected to travel both **in** (pipe expansion) and **out** (pipe contraction) of its cylinder, there must be travel available in both directions as shown in Figure 4. This requires that T.E.D. units must be installed with the piston partially extended. The piston should be extended based on the ambient temperature at the time of installation and can be accurately calculated by the following formula:

$$P = \frac{T_M - T_A}{T_M - T_L} \times E$$

where:

- P = piston travel position at installation (in.)
- T_M = maximum operational temperature, °F (°C)
- T_A = ambient air installation temperature, °F (°C)
- T_L = minimum operational temperature, °F (°C)
- E = piston full extension length (in.)

Example 11

For a straight run of pipe, the ambient air temperature at time of installation is 68°F and the temperature of system operation varies from 40°F to 90°F. How much piston travel should a 6" expansion joint be installed with?

Known: T_M = 90°F, T_A = 68°F, T_L = 40°F, L = 6 in

$$P = \frac{90 - 68}{90 - 40} \times 6$$

$$P = 2.64 \text{ in}$$

Therefore, the piston travel position should be set during installation by compressing the piston fully, then extending it 2.64".

Figure 5 – Expansion Joint

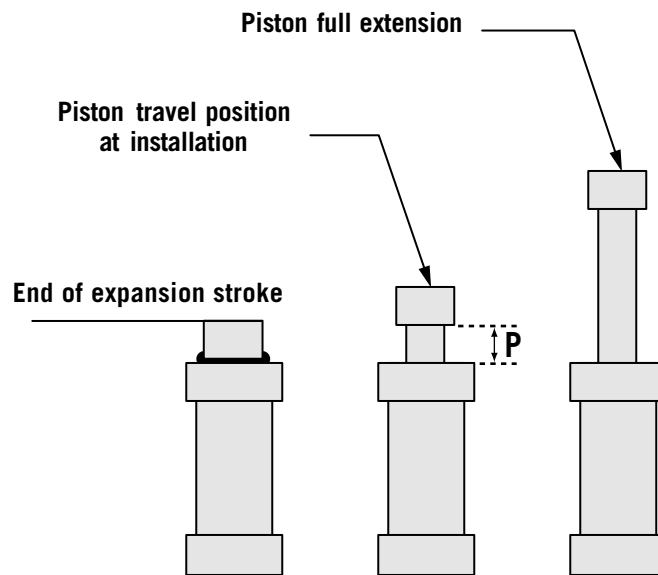

T.E.D. Specifications and Dimensions

The T.E.D. is available in PVC and CPVC, each featuring EPDM or FPM O-rings to meet all application requirements.

Figure 6 - IPEX Telescopic Expansion Joint

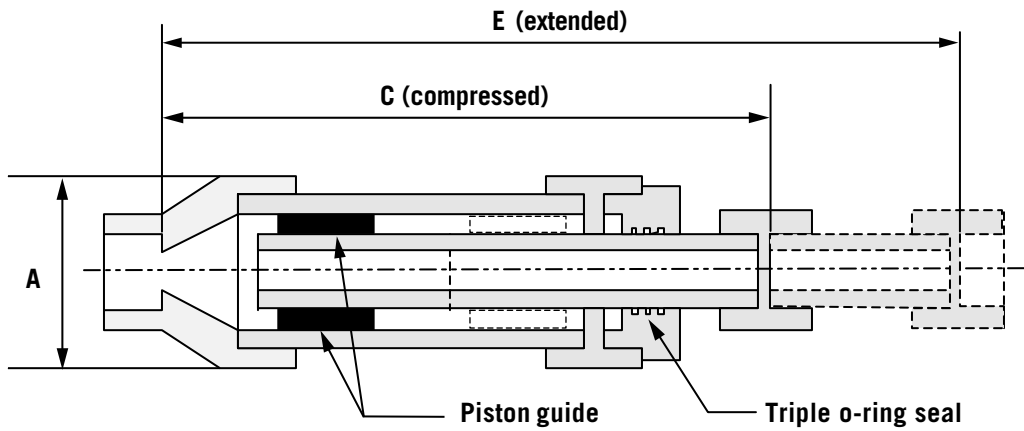

Size (in.)	A (in.)	6" Travel (L = 6)		12" Travel (L = 12)		Maximum Pressure Rating at 73°F (psi)
		C (in.)	E (in.)	C (in.)	E (in.)	
1/2	2.80	12.75	18.75	18.75	30.75	235
3/4	2.80	12.75	18.75	18.75	30.75	235
1	2.80	11.75	17.75	17.75	29.75	235
1 1/2	4.20	12.75	18.75	18.75	30.75	235
2	4.20	12.00	18.00	18.00	30.00	235
3	5.20	16.25	22.25	22.25	34.25	150
4	7.80	15.25	21.25	21.25	33.25	150

Note: For system fluid temperatures greater than 73°F (23°C), the appropriate temperature correction factor must be used. See Table 9.

Water Hammer / Surge

Surge pressures due to water hammer should be considered when designing a piping system. A momentary pressure rise occurs when the flow of liquid is started and stopped quickly, as a result of the fluid's momentum. Pressure rise increases with the velocity of the liquid, the length of the piping system from the liquid source, or with an increase in the speed of starting or stopping. Examples of hydraulic shock occur when valves are opened or closed quickly, or pumps are started with an empty discharge line. Proper design when laying out a piping system will minimize the possibility of hydraulic shock damage. The following suggestions will help avoid problems:

- 1) In any piping system, including thermoplastic, a liquid velocity not exceeding 5 ft./sec. will lessen hydraulic shock effects, even with quick-closing valves (e.g. solenoid valves).
- 2) Using actuated valves with a specific closing time will reduce the possibility of inadvertent opening or closing of a valve too quickly. With pneumatic and air-spring actuators, it may be necessary to place a valve in the air line to slow down the valve operation cycle.
- 3) Evaluate flow at pump start-up and during spin-down. Also determine how much air, if any, is introduced during pump start-up.
- 4) If possible, when starting a pump, partially close the valve in the discharge line to minimize the volume of liquid that is rapidly accelerated through the system. Once the pump is up to speed and the line completely full, the valve may be opened.
- 5) Use surge control devices and standpipes wisely to give flow storage during surge and to minimize column separation. Check valves can be used near pumps to help keep lines full.
- 6) Use properly sized vacuum breaker-air relief valves to control the amount of air that is admitted or exhausted throughout the system.

Note: Common industry practices suggest that in systems with quick-closing valves or cyclic surge conditions, fitting pressure rating should be calculated at not more than 60% of the equivalent pipe.

Calculations used to predict water hammer are based on elastic wave theory. The formula for calculating the surge pressure for any liquid assuming instantaneous valve closure is:

$$p = \frac{d}{g}$$

$$a = \frac{\left[\sqrt{\frac{K}{p}} \right] \times 12}{\sqrt{1 + \left[\frac{K}{E} \right] \times (DR - 2)}}$$

$$P_s = \frac{d \times a \times V}{144 \times g}$$

where:

- p = fluid density / gravity acceleration (slugs /ft³.)
- a = wave velocity (ft/sec)
- K = bulk modulus of fluid (psi)
- E = modulus of elasticity of pipe (psi)
- DR = dimension ratio of pipe
- g = gravitational acceleration constant (32.17 ft/sec²)
- d = density (lb/ft³)
- V = change in velocity (ft/s)
- P_s = maximum surge pressure (psi)

Example 12

A valve is suddenly closed in a 2" PVC Schedule 80 pipe carrying fluid with a specific gravity (s.g.) of 1.2 at a flow rate of 30 US gpm. The system pressure is 160 psi at ambient temperature. Determine the surge pressure under these conditions and if the system is able to sustain it.

Known:

- d = 1.2 (g/cm³) or 74.914 lb/ft³
- g = 32.174 ft/sec²
- K = 313,000 psi (for water)
- E = 400,000 psi (from Table 13 or Table 15)
- DR = 11 (from Table A-14 Dimensions, Weights & Pressure Ratings)
- V = 30 gpm or 3.35 ft/s

$$p = \frac{74.914}{32.174}$$

$$p = 2.328$$

$$a = \frac{\left[\sqrt{\frac{313000}{2.328}} \right] \times 12}{\sqrt{1 + \left[\frac{313000}{400000} \right] \times (11 - 2)}}$$

$$a = 1551.514$$

$$P_s = \frac{74.914 \times 1551.514 \times 3.35}{144 \times 32.174}$$

$$P_s = 84.04$$

Total line pressure = 84 + 160 = 244 psi

The pressure rating for 2" Schedule 80 PVC pipe is 400 psi, therefore the system is well able to sustain a total line pressure of 244 psi.

To prevent rapid valve closure from creating high surge pressures, the minimum closure time of a valve can be calculated. The following formula would apply:

$$T = \frac{2 \times L}{a}$$

where:

- T = minimum closure time (sec)
- L = length of pipe from valve to point of relief (ft)
- a = velocity of fluid (ft/sec)

Example 13

A 2" PVC Schedule 40 pipe is 250 feet long and is connected to a tank. The water velocity in the 2" pipeline is 5 ft./sec. What is the minimum valve closure time required to prevent an instantaneous pressure surge?

Step 1: Calculate the wave velocity (a)

Known:

- d = 0.9975 (g/cm³) or 62.272 lb/ft³
- g = 32.174 ft/sec²
- K = 313,000 psi (for water)
- E = 400,000 psi (from Table 13 or Table 15)
- DR = 16 (from Table A-14 Dimensions, Weights & Pressure Ratings)
- V = 5 ft/s

$$p = \frac{62.272}{32.174}$$

$$p = 1.935$$

$$a = \frac{\left[\sqrt{\frac{313000}{1.935}} \right] \times 12}{\sqrt{1 + \left[\frac{313000}{400000} \right] \times (16 - 2)}}$$

$$a = 1395.69$$

Step 2: Calculate the critical time

$$T = \frac{2 \times 250}{1395.69}$$

$$T = 0.36 \text{ seconds}$$

In this case, if the valve takes 0.36 seconds or longer to close, the amount of pressure surge is considered negligible. Therefore the fitting pressure rating will not need to be derated.

Thermal Conductivity

Compared with traditional pipe materials, the thermal conductivity of vinyl is low and it essentially acts as an insulator. This insulating property provides a distinct advantage over traditional materials to prevent "sweating" or formation of condensation on the pipe wall. The need for insulation may, in certain instances, be completely eliminated by using vinyl for cold or chilled water lines. Thermal conductivity for various material types is shown in Table 14.

Thermal conductivity is expressed as BTU/hr./sq.ft./°F/in. where BTU/hr. or British Thermal Unit per hour is defined as the energy required to raise the temperature of one pound of water one degree Fahrenheit in one hour. Square feet, refers to the square foot area where heat is being transferred. Inch refers to one inch of pipe wall thickness.

The graph shown in Figure 7 gives an example of the extent to which vinyl piping products will prevent the formation of condensation at different temperatures of the process fluid. For example, copper, a good conductor of heat, will lose 2700 BTU per hour per square foot of surface area with a wall thickness of 1" while vinyl will lose only 1.2 BTU/hr. Note that if the vinyl wall thickness is reduced to 0.25 inches, the heat loss increases four times.

Figure 7 - Relative Humidity at which condensation will form on pipe walls

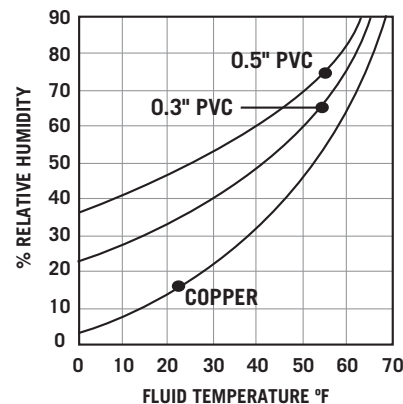

Wall thickness (in)	Sch 40 Vinyl Pipe	Sch 80 Vinyl Pipe
0.3	1/2" to 6"	1/4" to 3"
0.5	8" to 16"	4" to 8"

Table 14 - Coefficients of Thermal Conductivity

Material	BTU/hr./sq.ft./°F/in	W/m/°K
CPVC	0.95	0.137
PVC	1.20	0.1731
Glass	8	1.1538
Carbon Steel	360	51.922
Aluminum	1,000	144.23
Copper	2,700	389.42

To calculate the approximate heat loss or gain for plastic piping with no insulation in a still air environment, the following calculation formula can be used:

$$q = \frac{\pi \times L \times (D_o - D_i)}{\ln\left(\frac{D_o}{D_i}\right)} \times K \times \frac{\Delta t}{(r_o - r_i)}$$

where:

- q = Rate of heat conduction, $\frac{\text{Btu}}{\text{h}}$
- Δt = Difference in temperature, °F
- D_o = Average outside diameter, ft
- D_i = Average inside diameter, ft
- r_o = Average outside radius, in.
- r_i = Average inside radius, in.
- L = Length, ft
- K = Coefficient of thermal conductivity, $\frac{\text{Btu} \times \text{in}}{\text{h} \times \text{ft}^2 \times ^\circ\text{F}}$
- ln = Natural logarithm
- π = 3.14

Note that in more complex situations, heat loss or gain should be calculated taking into account such things as heat transfer coefficients, fluid conductivity, fluid heat capacity, viscosity, air temperature and air velocity. Refer to engineering handbooks for more information.

Vacuum Service

Vinyl piping is often used in applications for suction or vacuum lines. Absolute vacuum or 1 standard atmosphere = 14.676 psi or 29.87 inches of mercury. Full vacuum of one atmosphere would only occur at sea level and is reduced by 0.5 psi for every 1,000 feet of elevation above sea level.

PVC Schedule 40/80 and Series pipe to 24" are suitable for vacuum service at ambient temperatures. For elevated temperatures, use the temperature correction factors in Table 9 to determine the appropriate pressure rating and suitability for service. For a circular ring subjected to a uniform external pressure or internal vacuum, the critical buckling pressure is calculated as follows:

$$P_{cr} = \frac{2EC}{(1-\sigma^2)} \left[\frac{t}{D_o - t} \right]^3$$

- P_{cr} = critical buckling pressure (psi)
- E = modulus of elasticity (psi)
- C = critical buckling correction factor
- σ = Poisson's ratio
- t = minimum wall thickness (in.)
- D_o = outside diameter (in.)

Note: For non-encased, non-deflected unburied pipe, the critical buckling correction factor (C) is 1.0. For buried pipe see the following section on vacuum service below ground.

Table 15 – Modulus of Elasticity at Elevated Temperatures (E)

Piping Material	Temp, °F	Temp, °C	E, psi
PVC	73	23	400,000
	90	32	372,000
	110	43	336,000
	140	60	280,000
CPVC	73	23	423,000
	90	32	403,000
	110	43	371,000
	140	60	323,000
	180	82	269,000
	210	93	220,000

Example 14

Above Ground Vacuum Service Installation

A process piping system operating at 90°F has a suction line that requires a full vacuum (-29.86" Hg (mercury) or -14.67 psi). Determine if 3" Schedule 80 PVC is capable of operating under these conditions.

Knowns:

- σ = 0.38 (from Table 1, Physical Properties)
- E = 372,000 psi (from Table 15, Modulus of Elasticity at Elevated Temperatures)
- D_o = 3.5 in. (from Table A-14 - Dimensions, Weights & Pressure Ratings)
- t = 0.3 in. (from Table A-14 - Dimensions, Weights & Pressure Ratings)

$$P_{cr} = \frac{1 \times 2 \times 372000}{(1 - 0.38^2)} \left[\frac{0.3}{3.5 - 0.3} \right]^3$$

- C = 1 (the system is above ground)
- P_{cr} = 716 psi

Therefore, the pipe is capable of vacuum service under these conditions, as the critical buckling pressure is greater than the vacuum pressure required.

Below Ground Installation

Pipes that are significantly out of round or deflected have less buckling resistance than round pipes. The critical buckling pressure for these elliptical shapes can be determined by using a correction factor “C” as shown in the graph in Figure 8.

Figure 8 - Critical Buckling Pressure Correction Factor (C) for buried pipe

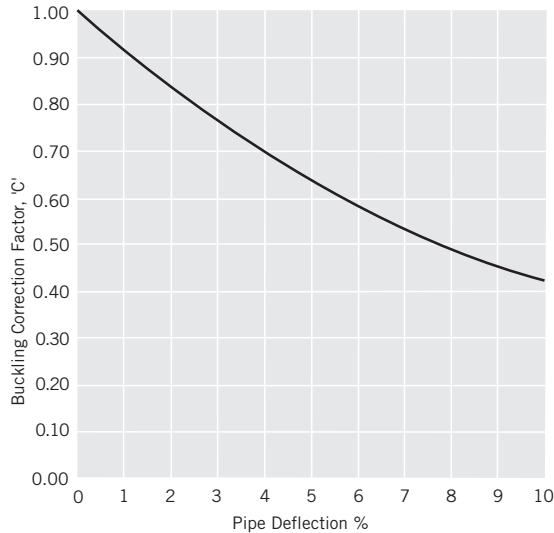

When pipes are buried or installed in such a manner that the soil or surrounding medium provides some resistance against buckling or deflection, the buckling pressure (P_b) in the soil has been found to be:

$$P_b = 1.15 \sqrt{P_{cr}} E'$$

where:

P_b = buckling pressure in a given soil (psi)

P_{cr} = critical buckling pressure (psi)

E' = modulus of soil reaction (psi)

Table 16 – Average Values of Modulus of Soil Reaction (E')*

Pipe Bedding Material	E' for degree of compaction of bedding (psi)			
	Dumped	Slight <85% Proctor	Moderate 85- 95% Proctor	High >95% Proctor
Fine grained soils (<25% coarse grained particles)	50	200	400	1000
Fine grained soils (>25% coarse grained particles)	100	400	1000	2000
Coarse grained soils (fines <12%)	200	1000	2000	3000
Crushed Rock	1000	3000	3000	3000

*Source: Uni-Bell Handbook of PVC Pipe

Note: Values applicable for fills less than 15 ft. Table does not include any safety factor, therefore appropriate deflection lag factor must be applied for long-term deflections.

Example 15

Below Ground Vacuum Service Installation

A water treatment plant has a buried tank that requires the removal of chemicals. The system operating temperature is 73°F. The pipe work is buried 15 feet below grade in clean sand and gravel with 90% density proctor and a weight of 120 lb/ft.³. Is 4" Sch 80 PVC pipe capable of operating at full vacuum (-14.7 psi) under these conditions?

Known:

- db = 15 ft
- w = 120 lb/ft³ based on soil with bulk specific gravity of 1.93 g/cm³ (For more specific data see Published Soil Engineering Handbooks on soil density calculations.)
- E = 400,000 psi (from Table 15, Modulus of Elasticity at Elevated Temperatures)
- σ = 0.38 (from Table 1, Physical Properties)
- DR = 13 (from Table A-14, Dimensions, Weights & Pressure Ratings)
- D_o = 4.5 in. (from Table A-14, Dimensions, Weights & Pressure Ratings)
- t = 0.337 in. (from Table A-14, Dimensions, Weights & Pressure Ratings)
- E' = 2000 psi (from Table 16, Modulus of Soil reaction)
- K = 0.11 (standard bedding factor)

In order to calculate the true buckling pressure, a number of steps are required. First the actual deflection under these conditions needs to be determined. This will allow a correct buckling pressure correction factor to be derived from the graph. Then the pipe buckling pressure can be determined and finally the soil buckling pressure can be calculated.

Step 1: Calculate Actual Deflection

(A) Determine Earth Load

$$P_e = db \times w$$

Where:

- P_e = earth load (lbs/ft²)
- db = depth of burial (ft)
- w = weight of soil (lbs/ft³)
- P_e = 15 x 120
- = 1800 lbs/ft² or 12.5 lbs/in²

(B) Determine Pipe Stiffness

$$P_s = 4.47 \times \frac{E}{(DR-1)^3}$$

Where:

- P_s = pipe stiffness (psi)
- E = modulus of elasticity
- DR = dimension ratio

$$P_s = 4.47 \times \frac{400000}{(13-1)^3} = 1035 \text{ psi}$$

(C) Determine Actual Pipe Deflection

$$D_f = \frac{K \times P_e}{(0.149 \times P_s + 0.061 \times E')} \times 100\%$$

Where:

- D_f = pipe deflection (%)
- P_e = earth load (lbs/in²)
Note: Units (lbs/in²) can also be displayed as (psi)
- K = standard bedding factor
- P_s = pipe stiffness (psi)
- E' = modulus of soil reaction

$$D_f = \frac{0.11 \times 12.5}{(0.149 \times 1035 + 0.061 \times 2000)} \times 100\% = 0.497\%$$

Step 2: Determine pressure correction factor 'C' from the graph in Figure 8

$$C = 0.94$$

Step 3: Determine pipe critical buckling pressure

$$P_{cr} = \frac{2EC}{(1 - \sigma^2)} \left[\frac{t}{D_o - t} \right]^3$$

Known:

- σ = 0.38 (from Table 1, Physical Properties)
- E = 400,000 psi (from Table 15, Modulus of Elasticity at Elevated Temperatures)
- D_o = 4.5 in. (from Table A-14, Dimensions, Weights & Pressure Ratings)
- t = 0.3 in. (from Table A-14, Dimensions, Weights & Pressure Ratings)
- C = 0.94

$$P_{cr} = \frac{0.94 \times 2 \times 400000}{(1 - 0.38^2)} \left[\frac{0.3}{4.5 - 0.3} \right]^3$$

$$P_{cr} = 320 \text{ psi}$$

Step 4: Determine the Soil Critical Buckling Pressure

$$P_b = 1.15 \sqrt{P_{cr} E'}$$

Known:

$$P_{cr} = 320 \text{ psi}$$

$$P_b = 1.15 \sqrt{320 \times 2000}$$

$$E' = 2,000 \text{ psi (from Table 16, Modulus of Soil Reaction)}$$

$$P_b = 920 \text{ psi}$$

Therefore the pipe can withstand full vacuum service.

Deflection

Thermoplastic pipe is considered to be a flexible rather than a rigid piping material when referring to deflection. This means that under loading, the pipe tends to deflect rather than crack. The amount of deflection can be derived from the depth of burial, pipe stiffness and the amount of loading (e.g. soil, traffic) on the pipe. Although the maximum allowable deflection is 7.5%, critical buckling occurs at 30%, providing for a safety factor of 4. For further detail refer to In Ground Installation in Section 3.

Drainage

Piping systems for drainage applications usually consist of low pressure, half or full flow discharge systems that are horizontal or slightly sloping. Friction loss for open channel flow can be determined by the Manning formula as follows.

$$V = \frac{(1.49) R^{0.67} S^{0.5}}{n}$$

where:

- V = average velocity (ft/sec)
- R = hydraulic radius (ft)
- S = slope (ft/ft)
- n = roughness coefficient

Values of the roughness coefficient (n) have been determined by many tests on actual pipe. Common values are shown in Table 17. Further sizing and flow capacity information for drainage systems can be found in Table 18.

Table 17 – Manning Roughness Coefficient (n)

Material	n
PVC / CPVC	0.009
Glazed surface	0.010
Concrete	0.013
Cast Iron	0.015
Corrugated Metal	0.022

As shown in Table 17, PVC and CPVC have the smoothest interior walls of several common piping materials. It should also be noted that if self cleansing velocities of 2 ft/s or more are maintained, the pipe will continue to be resistant to bacterial growth and particulate deposition and will keep friction loss to a minimum, thereby maintaining its intended flow rate over the life of the installed system.

Table 18 - Discharge Capacity for PVC Drainage Systems

Pipe Size (in)	Slope		Discharge Capacity		Velocity (ft/s)
	in/ft	%	(gpm) US	(ft ³ /s)	
2	1/2	4.2	27	0.061	2.80
3	1/2	4.2	81	0.180	3.67
4	1/2	4.2	174	0.390	4.47
6	3/16	1.5	309	0.687	3.50
8	1/16	0.5	420	0.937	2.68
10	1/16	0.5	761	1.700	3.12
12	1/16	0.6	1239	2.760	3.51
14		0.2	1074	2.390	2.24
16		0.2	1484	3.310	2.35

* Note: Pipe capacities are based on the pipe flowing at full capacity. (Source: ASPE Data Book)

Example 16

A drainage system consisting of 2" Schedule 40 PVC pipe is 200 feet long. The system is installed with a slope of 1/4" per ft. Determine the flow rate.

$$V = \frac{(1.49) R^{0.67} S^{0.5}}{n}$$

$$Q = A \times V$$

where:

$$Q = \text{flow rate (ft}^3\text{/sec)}$$

$$A = \text{cross-sectional area of pipe } (\pi r^2)$$

Known:

$$D_i = 2.047" \text{ (from Table A-14, Dimensions, Weights \& Pressure Ratings)}$$

$$R = D_i/4 = (2.047/4) = 0.5112" \text{ or } 0.0426'$$

$$n = 0.009 \text{ (from Table 17, Manning Roughness Coefficient)}$$

$$S = 1/4"/\text{ft or } 0.0208'/\text{ft}$$

$$A = 3.14 (0.0426/2)^2 = 0.023 \text{ ft}^2$$

$$V = \frac{(1.49) \times (0.0426)^{0.67} \times (0.0208)^{0.5}}{0.009}$$

$$V = 165.56 \times 0.121 \times .144 = 2.88 \text{ ft/sec}$$

$$Q = 2.88 \times 0.023 = 0.065 \text{ ft}^3\text{/sec or } 29.2 \text{ gpm}$$

Therefore, the flow rate is 29.2 US gpm.

Fittings

At the time of this publication, there are no accredited standards that deal with the pressure ratings of molded schedule fittings. Common industry practice values the pressure of the fitting equal to that of the corresponding size and schedule of pipe. Experience tells us however, that in systems with quick closing valves or the potential for cyclic surge conditions, (as is true of most process systems), fitting pressure ratings should be calculated at 60% of the equivalent pipe ratings to obtain a sufficient safety factor.

Molded Fittings

Molded fittings are usually preferred by engineers, contractors and end users because they are seamless (better flow), have a tighter radius (requiring less space) and are dimensionally identical (easier installation). In addition, molded fittings are cosmetically more appealing than fabricated fittings. This may be an important consideration for exposed pipelines (e.g. aquariums, water works).

Weld Lines

A weld line is a visible line on a molded fitting, both inside and out, where the plastic material fuses together during the injection molding operation.

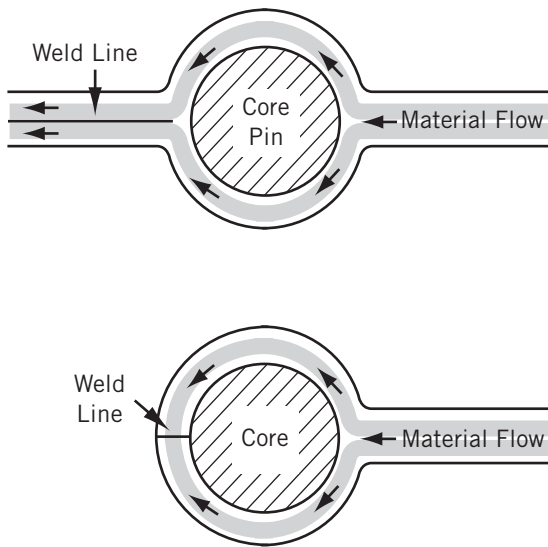

EVERY injection molded fitting will have a weld line. It will appear wherever the material has rejoined after flowing around a core.

A weld line should not be confused with the mold parting line which also appears on a molded fitting. The parting line is formed by the two halves of a mating mold cavity. Parting lines are usually much more visible than weld lines.

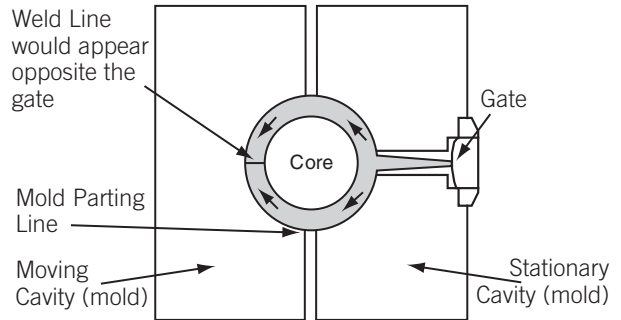

Continual advances in injection molding technology have allowed manufacturers to increase their range of molded fittings. IPEX is one of the very few manufacturers capable of molding both Schedule 40 and 80 PVC and Schedule 80 CPVC fittings in 10" and 12" sizes. Thus, IPEX offers one of the most complete and technologically advanced fittings lines in the industry. IPEX Xirtec140 PVC and Corzan CPVC injection molded fittings are manufactured in accordance with ASTM standards.



Fabricated Fittings

IPEX fabricated fittings are high integrity fittings designed and engineered to meet demanding process pipe requirements. Fabricated fittings in larger pipe sizes (above 8") are made from segments of IPEX plastic pipe welded together or butt-fused and fiberglass reinforced. Custom configurations or standard designs such as tees and elbows are manufactured by these techniques.

Hot-air gun welding (or stick welding) is a process in which mitered segments of pipe are welded together through the use of a welding rod and a hot-air gun. This is done by first beveling the outer edges of each pipe segment. The outer edges of the segments are then lined up and held firmly together. A welding rod is held to the joint. The hot-air gun is applied to the rod and several beads are laid all around the circumferences of the joint area. The heat simultaneously melts the outer surface of the pipe segments as well as the rod. As the material cools down and hardens, a permanent bond is created between the two pieces.

Butt-fusion is a welding process that also uses heat to melt the edges of the two pipe segments to be joined. However during butt-fusion, substantial pressure is applied to the pipe, effectively increasing the density of the material at the weld. Because of this, the extent of heat penetration and the size of the welded surface area of a butt-fusion weld are greater than that of a hot-air gun weld. Therefore, a butt-fusion weld has greater strength than a hot air gun weld and is the method of choice. Due to differing geometries and sizes, not all fittings can be butt-fused. In those cases, hot air welds are made.

In order to reach the highest level of performance and equivalent integrity (regardless of fabrication technique) IPEX fiberglass over-wraps its fabricated "full pressure" rated fittings. This step results in all IPEX (either hot air gun welded or butt-fused) fabricated fittings having mechanical and pressure capabilities, which often exceed those of the pipe they will be connected to. The fittings, together with IPEX thermoplastic pipe, form a complete and unified system.

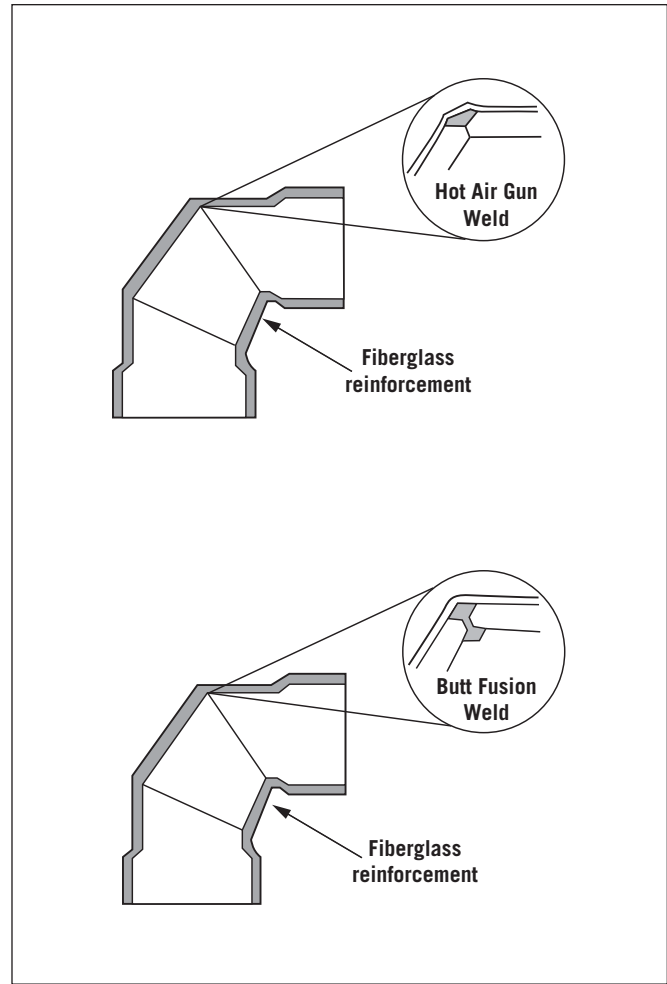

Full Pressure Fabricated Fittings

Valves

Valve Selection

The selection of a valve is based on its function and the way in which it will be operated in the system. In general, valves are used to perform at least one of three functions: (1) shut off, (2) throttling, and (3) preventing backflow. See Table 19 – Thermoplastic Valves for a complete listing of IPEX vinyl valves.

- 1) For on-off service, the most commonly used IPEX valves are:
 - ball valves
 - butterfly valves
- 2) For throttling or flow regulating, the most commonly used IPEX valves are:
 - diaphragm valves
 - butterfly valves
- 3) For preventing reversal or backflow, the most commonly used IPEX valves are:
 - ball check valve
 - piston check valve
 - swing check valve

Since there can be more than one choice for a particular function, the selection process can be refined by considering specific system characteristics. These include:

- Characteristics of the flowing medium
 - corrosiveness
 - abrasiveness
 - viscosity
 - temperature
 - pressure
- The compatibility of the valve's fluid-control elements (i.e. weirs, stems, seats, etc.) with the flowing medium,
- Physical space requirements
- Weight limitations
- Operational requirements
 - manually operated valves offer a choice of levers, gears, and other handles, depending on size.
 - remotely operated valves can be actuated either electrically or pneumatically.

Actuated Valves

Rotary valves, such as ball valves, butterfly valves and diaphragm valves can be combined with an automatic actuator. Powered either electrically or pneumatically, the actuator allows automatic sequencing of the valve operation.

The demand for actuated valves has been steadily increasing due to increasing labor costs for manually operated valves (especially in remote locations). Freeing up valuable work hours for more productive jobs is only one reason automated valves are popular. Actuated valves also increase profit and productivity, provide closer control of critical processes and help to eliminate human error.

Operational advantages of using an actuated valve are:

- Adapts easily and economically to full modulating control.
- Allows automatic sequencing of valve operation in multi-stage or multi-mix systems that are difficult, if not impossible, to coordinate manually.
- Offers a variety of cost and labor saving options that fit process requirements and industrial environments more precisely.
- Provides fail-safe modes and eliminates the need for workers to manually operate a valve carrying hazardous fluids.

Actuator Selection

The choice of actuators should not be solely influenced by either features or price. Consideration should also be given to the cost of supplying motive power, installation and maintenance, service life and possible future replacement.

There are two basic types of actuators; electric and pneumatic. If electricity and air are available, the first consideration is the type of power desired. Although electric and pneumatic actuators have approximately equal torque output ratings for sizes 4" and larger, pneumatic actuators are normally less expensive. However, in smaller sizes, the electric actuator's lighter weight and simplified installation make it ideal for many applications.

Consideration should also be given to the speed control of both electric and pneumatic actuators. Closing a valve too quickly on flowing fluid can cause water hammer and subsequent damage to the valve and related piping. The speed of both electric and pneumatic actuators can be specifically tailored to each application. Some pneumatic actuators can be adjusted in-line to obtain the correct cycle time for a specific application.



Table 19 – IPEX Thermoplastic PVC & CPVC Valves

Valve Type	Size (in)	Material	Connection/ Style*	Rating (psi)
MP Compact Ball Valve	½ to 2	PVC	S, T	150
VE Double Blocking Ball Valve, True Union	½ to 2	PVC	S, T, Tu	232
VX Double Blocking Ball Valve, True Union	½ to 6	PVC, CPVC	F, S, T, Tu	232 (½ to 2) 150 (2½ to 6)
VK Double Blocking Ball Valve, True Union	½ to 6	PVC, CPVC, PP	F, S, T, Tu	232 (½ to 2)
VKD Double Blocking Ball Valve, True Union	2½ to 4	PVC, CPVC	S, Tu	232
VT/VL L-Port, T-Port Three-Way Ball Valve	½ to 2	PVC	F, S, T, Tu	150
TK Three-Way Ball Valve	½ to 2	PVC, PP	F, S, T, Tu	232
FE Butterfly Valve	1½ to 12	PVC	F (W)	232 (1½ to 2) 150 (2½ to 10) 120 (12)
FK Butterfly Valve	1½ to 12	Body GFPP Disk PP	F (W, L)	150 (1½ to 10) 120 (12)
VB Ball Check Valve	½ to 4	PVC, CPVC	F, S, T, Tu	150
VR Piston Check Valve	½ to 4	PVC	F, S, T, Tu F, S, T	232 (½ to 1) 150 (1¼ to 2) 90 (3 to 4)
SC Swing Check Valve	3 to 8	PVC	F	100 (3) 70 (4 to 8)
RV Y-Pattern Sediment Strainer	½ to 4	PVC, CPVC	F, S, T, Tu F, S, T, Tu F, S, T	232 (½ to 1) 150 (1¼ to 2) 60 (3 to 4)
CM Compact Diaphragm Valve	¾ to ½	PVC, CPVC, PP, PVDF	S, T	90
VM Diaphragm Valve	½ to 4	PVC, CPVC, PP, PVDF	F, S, T, Tu F, Si	150 (½ to 2) 150 (2½ to 4)
DM Direct- Acting Diaphragm Valve	½ to 2	PVC, CPVC	F, S, Si, Tu	120
DV Integrally Flanged Diaphragm Valve	½ to 6	PVC	F	150
VA Air Release Valve	¾, 1¼, 2	PVC	Su, T	232
SF Solenoid	¼, ½	PVC	T, Tu	60 (¼) 30 (½)
LV Lab Valve	¼	PVC	T	150

Style Legend

F = Flanged (ANSI 150)	Su = Single Union
L = Lug	T = Threaded (NPT)
S = Socket (IPS)	Tu = True Union
Si = Spigot (IPS)	W = Wafer

(See also IPEX Technical Manual, Volume VII - Thermoplastic Valve Manual)

NOTES

SECTION THREE: INSTALLATION

INTRODUCTION

Proper installation is key to producing a stable and robust system. If installation is not done correctly, the system will not perform well and may actually fail.

This section will cover all aspects of installation and will include joining methods, in ground and above ground installation methods, pipe supports, handling and storage, other installation considerations (such as entrapped air) and testing.



HANDLING AND STORAGE



PVC and CPVC are strong, lightweight materials, about one fifth the weight of steel or cast iron. Piping made of this material is easily handled and, as a result, there is a tendency for them to be thrown about on the jobsite. Care should be taken in handling and storage to prevent damage to the pipe.

PVC and CPVC pipe should be given adequate support at all times. It should not be stacked in large piles, especially in warm temperature conditions, as bottom pipe may become distorted and joining will become difficult.

For long-term storage, pipe racks should be used, providing continuous support along the length. If this is not possible, timber supports of at least 3" bearing width, at spacings not greater than 3' centers, should be placed beneath the piping. If the stacks are rectangular, twice the spacing at the sides is required. Pipe should not be stored more than seven layers high in racks. If different classes of pipe are kept in the same rack, pipe with the thickest walls should always be at the bottom. Sharp corners on metal racks should be avoided.

For temporary storage in the field when racks are not provided, care should be taken that the ground is level and free of sharp objects (i.e. loose stones, etc.). Pipe should be stacked to reduce movement, but should not exceed three to four layers high.

Most pipe is now supplied in crates. Care should be taken when unloading the crates; avoid using metal slings or wire ropes. Crates may be stacked four high in the field.

The above recommendations are for a temperature of approximately 80°F (27°C). Stack heights should be reduced if higher temperatures are encountered, or if pipe is nested (i.e. pipe stored inside pipe of a larger diameter). Reduction

in height should be proportional to the total weight of the nested pipe, compared with the weight of pipe normally contained in such racks.

Since the soundness of any joint depends on the condition of the pipe end, care should be taken in transit, handling and storage to avoid damage to these ends. The impact resistance and flexibility of both PVC and CPVC pipe are reduced by lower temperature conditions. The impact strength for both types of piping materials will decrease as temperatures approach 32°F (0°C) and below. Care should be taken when unloading and handling pipe in cold weather. Dropping pipe from a truck or forklift may cause damage. Methods and techniques normally used in warm weather may not be acceptable at the lower temperature range.

When loading pipe onto vehicles, care should be taken to avoid contact with any sharp corners (i.e. angle irons, nail heads, etc.), as the pipe may be damaged.

While in transit, pipe should be well secured and supported over the entire length and should never project unsecured from the back of a trailer.

Larger pipe may be off-loaded from vehicles by rolling them gently down timbers, ensuring that they do not fall onto one another or onto a hard, uneven surface.

Prolonged Outdoor Exposure

Prolonged exposure of PVC and CPVC pipe to the direct rays of the sun will not damage the pipe. However, some mild discoloration may take place in the form of a milky film on the exposed surfaces. This change in color merely indicates that there has been a harmless chemical transformation at the surface of the pipe. A small reduction in impact strength could occur at the discolored surfaces but they are of a very small order and are not enough to cause problems in field installation.

Protection – Covering

Discoloration of the pipe can be avoided by shading it from the direct rays of the sun. This can be accomplished by covering the stockpile or the crated pipe with a light colored opaque material such as canvas. If the pipe is covered, always allow for the circulation of air through the pipe to avoid heat buildup in hot summer weather. Make sure that the pipe is not stored close to sources of heat such as boilers, steam lines, engine exhaust outlets, etc.

Protection – Painting

PVC and CPVC pipe and fittings can be easily protected from ultraviolet oxidation by painting with a heavily pigmented, exterior water-based latex paint. The color of the paint is of no particular importance; the pigment merely acts as an ultraviolet screen and prevents sunlight change. White or some other light color is recommended as it helps reduce pipe temperature. The latex paint must be thickly applied as an opaque coating on pipe and fittings that have been well cleaned and very lightly sanded.

JOINING METHODS – SOLVENT CEMENT

Basic Principles

To make consistently tight joints, the following points should be clearly understood:

1. The joining surfaces must be softened and made semi-fluid.
2. Sufficient cement must be applied to fill the gap between pipe and fittings.
3. Assembly of pipe and fittings must be made while the surfaces are still wet and fluid.
4. Joint strength will develop as the cement cures. In the tight part of the joint, surfaces tend to fuse together; in the loose part, the cement bonds to both surfaces.

These areas must be softened and penetrated

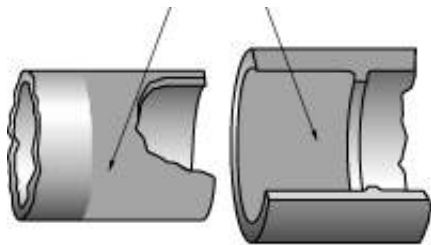

Penetration and softening can be achieved by the cement itself, by using a suitable primer, or by the use of both primer and cement. For certain materials and in certain situations, it is necessary to use a primer. A suitable primer will usually penetrate and soften the surfaces more quickly and effectively than cement alone. Additionally, the use of a primer can provide a safety factor for the installer, for he can know under various temperature conditions when he has achieved sufficient softening. For example, in cold weather more time and additional applications may be required.

Apply generous amounts of cement to fill the loose part of the joint. In addition to filling the gap, adequate cement layers will penetrate the surfaces and remain wet until the joint is assembled. To prove this, apply two separate layers of cement on the top surface of a piece of pipe. First, apply a heavy layer of cement; then alongside it, a thin, brushed-out layer. Test the layers every 15 seconds by gently tapping with your finger. You will note that the thin layer becomes tacky and then dries quickly (probably within 15 seconds); the heavy layer will remain wet much longer.

Check for penetration a few minutes after applying these layers by scraping them with a knife. The thin layer will have little or no penetration, while the heavy layer will have achieved much more penetration.

If the cement coatings on the pipe and fittings are wet and fluid when assembly takes place, they tend to flow together, becoming one cement layer. Also, if the cement is set, the surfaces beneath the pipe and fittings will still be soft. These softened surfaces in the tight part of the joint will fuse together.

As the solvent dissipates, the cement layer and the softened surfaces will harden with a corresponding increase in joint strength. In the tight (fused) part of the joint, strength will develop quicker than in the looser (bonded) part of the joint.

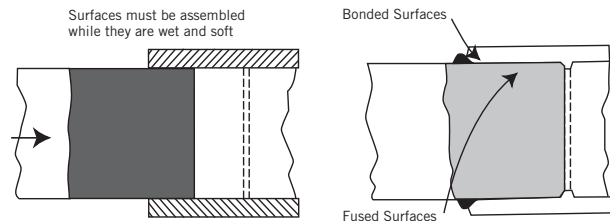

Cement Types

The use of a reliable cement, specifically manufactured for industrial PVC or CPVC, is critical to a good, long-lasting system and must conform to applicable ASTM standards. Review Table 20 for guidelines on cement types.

Table 20 – Cement Types

Pipe Size	Pipe Schedule	Socket Type	Cement Type
up to 6" PVC up to 4" PVC	40 80	All types	Medium-bodied fast-setting cement Use primer to soften and prepare joining surfaces
up to 12" PVC	All	All types	Heavy-bodied medium-setting cement for all schedules through 12" diameter water lines, drain lines and DWV Use primer to soften and prepare joining surfaces
up to 30" PVC	All	All types	Extra heavy-bodied slow-setting cement Use primer to soften and prepare joining surfaces
up to 12" CPVC	All	All types	Heavy-bodied medium-setting cement for pressure and non-pressure service Use primer to soften and prepare joining surfaces
up to 16" CPVC	All	All types	Extra heavy-bodied slow-setting cement Use primer to soften and prepare joining surfaces

Handling

Solvent cements should be used as received in original containers. Adding thinners to change the viscosity of cement is not recommended. If cement is jelly-like and not free flowing, it should not be used. Containers should be kept tightly covered when not in use to stop the evaporation of the solvent.

Storage Conditions

Solvent cements should be stored at temperatures between 40°F (4°C) and 110°F (43°C) away from heat or open flame. Cements should be used before the expiry date stamped on the container. If new cement is subjected to freezing temperatures, it may become extremely thick or gelled. This cement can be placed in a warm area where it will soon return to its original, usable condition. However, if hardening is due to actual solvent loss (when a container is left open too long during use or not sealed properly after use), the cement will not return to its original condition. Cement in this condition has lost its formulation and should be discarded in an environmentally safe manner.

Safety Precautions

Solvent cements are extremely flammable and should not be used or stored near heat or open flame including pilot lights. In confined or partially enclosed areas, a ventilating device should be used to remove vapors and minimize inhalation. Capping one end of a pipeline during construction may lead to an accumulation of flammable cement vapors inside the system. Nearby sparks may ignite these vapors and create a hazardous incident. If it is required to cover the pipe ends, use an air-permeable cloth that will prevent excessive amounts of dirt from entering the pipeline while permitting cement vapors to escape to the atmosphere. Alternatively, flushing the line with water will also remove all vapors after the cement has properly cured.

Containers should be kept tightly closed when not in use, and covered as much as possible when in use. Protective equipment such as gloves, goggles and an impervious apron should be used. Do not eat, drink or smoke while using these products. Avoid contact with skin, eyes or clothing. In case of eye contact, flush repeatedly with water. Keep out of the reach of children. Carefully read the Material Safety Data Sheets (MSDS) and follow all precautions.



WARNING

During the curing of the solvent cement joints, vapors may accumulate inside the pipeline, especially should one end of the line be capped. Nearby sparks from welders or torches may inadvertently ignite these vapors and create a hazardous incident. Attention should be given to removing all vapors using air-blowers or water flushing prior to capping one end of an empty pipeline.



CAUTION

Cement products are formulated for specific material types. To avoid potential joint failure, DO NOT USE PVC cement on CPVC components.

Solvent Cementing Instructions for PVC & CPVC Pipe & Fittings

Solvent Cementing with Primer

Step 1 Preparation

Assemble proper materials for the job. This includes the appropriate cement, primer and applicator for the size of piping system to be assembled. See Tables 23 and 24 for guidelines to estimate the amount of cement required.



Step 2 Cut Pipe

Pipe must be cut as square as possible. (A diagonal cut reduces bonding area in the most effective part of the joint.) Use a handsaw and miter box or a mechanical saw.



Plastic tubing cutters may also be used for cutting plastic pipe; however, some produce a raised bead at the end of the pipe. This bead must be removed with a file or reamer, as it will wipe the cement away when pipe is inserted into the fitting.



Step 3 Deburr Pipe Ends

Use a knife, plastic pipe deburring tool, or file to remove burrs from the end of small diameter pipe. Be sure to remove all burrs from around the inside as well as the outside of the pipe. A slight chamfer (bevel) of about 15° should be added to the end to permit easier insertion of the pipe into the fitting. Failure to chamfer the edge of the pipe may remove cement from the fitting socket, causing the joint to leak. For pressure pipe systems of 2" and above, the pipe must be end-treated with a 15° chamfer cut to a depth of approximately $\frac{3}{32}$ " (2.5mm).

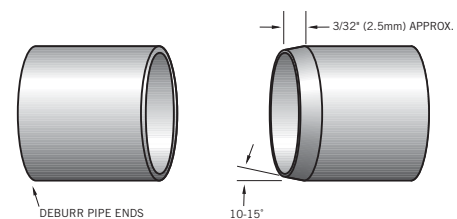

Step 4 Clean Pipe Ends

Remove all dirt, grease and moisture. A thorough wipe with a clean dry rag is usually sufficient. (Moisture will retard cure, dirt or grease can prevent adhesion).



Step 5 Check Fit

Check pipe and fittings for dry fit before cementing together. For proper interference fit, the pipe must go easily into the fitting one quarter to three quarters of the way. Too tight a fit is not desirable; you must be able to fully bottom the pipe in the socket during assembly. If the pipe and fittings are not out of round, a satisfactory joint can be made if there is a “net” fit, that is, the pipe bottoms in the fitting socket with no interference, without slop.

All pipe and fittings must conform to ASTM and other recognized standards.



Step 6 Select Applicator

Ensure that the right applicator is being used for the size of pipe or fittings being joined. The applicator size should be equal to half the pipe diameter. It is important that a proper size applicator be used to help ensure that sufficient layers of cement and primer are applied.



Step 7 Priming

The purpose of a primer is to penetrate and soften pipe surfaces so that they can fuse together. The proper use of a primer provides assurance that the surfaces are prepared for fusion.

Check the penetration or softening on a piece of scrap before you start the installation or if the weather changes during the day. Using a knife or other sharp object, drag the edge over the coated surface. Proper penetration has been made if you can scratch or scrape a few thousandths of an inch of the primed surfaces away.



Weather conditions can affect priming and cementing action, so be aware of the following:

- repeated applications to either or both surfaces may be necessary
- in cold weather, more time may be required for proper penetration
- in hot weather, penetration time may be shortened due to rapid evaporation

Step 8 Primer Application

Using the correct applicator, aggressively work the primer into the fitting socket, keeping the surface and applicator wet until the surface has been softened. More applications may be needed for hard surfaces and cold weather conditions. Re-dip the applicator in primer as required. When the surface is primed, remove any puddles of primer from the socket.



Step 9 Primer Application

Next, aggressively work the primer on to the end of the pipe to a point 1/2" beyond the depth of the fitting socket.

Immediately and while the surfaces are still wet, apply the appropriate IPEX cement.



Step 10 Cement Application

Stir the cement or shake can before using. Using the correct size applicator, aggressively work a full even layer of cement on to the pipe end equal to the depth of the fitting socket. Do not brush it out to a thin paint type layer, as this will dry within a few seconds.



Step 11 Cement Application

Aggressively work a medium layer of cement into the fitting socket.

Avoid puddling the cement in the socket. On bell end pipe do not coat beyond the socket depth or allow cement to run down into the pipe beyond the spigot end.



Step 12 Cement Application

Apply a second full, even layer of cement on the pipe.



Step 13 Assembly

Without delay, while the cement is still wet, assemble the pipe and fittings. Use sufficient force to ensure that the pipe bottoms in the fitting socket. If possible, twist the pipe a quarter turn as you insert it.



Step 14 Assembly

Hold the pipe and fitting together for approximately 30 seconds to avoid push out.

After assembly, a joint should have a ring or bead of cement completely around the juncture of the pipe and fitting. If voids in this ring are present, sufficient cement was not applied and the joint may be defective.



Step 15 Joint Cleaning

Using a rag, remove the excess cement from the pipe and fitting, including the ring or bead, as it will needlessly soften the pipe and fitting and does not add to joint strength. Avoid disturbing or moving the joint.



Step 16 Joint Setting & Curing

Handle newly assembled joints carefully until initial set has taken place. Allow curing to take place before pressurizing the system. (Note: in humid weather allow for 50% more curing time.)

For initial set and cure times for IPEX cements, refer to Tables 21 and 22.

Solvent Cementing without Primer / One Step Cements

If local codes permit, successful joints can be made without a primer using cement alone, but extra care must be given to the installation. It is important that a good interference fit exists between the pipe and fittings. It is for this reason we recommend that joints being made without a primer be limited to systems 2" and smaller for pressure applications or 6" and smaller for DWV or non-pressure applications. Extra care must also be given in applying cements to make sure proper penetration and softening of the pipe and fitting surfaces is achieved. Note that one step cements are not recommended at temperatures at or below 32°F (0°C).

Joining Large Diameter Pipe and Fittings

As pipe diameter increases so does the difficulty in installing it. For large diameter pipe, the following recommendations apply.

- Select the proper size of applicator. The use of proper size applicators is even more important for large pipe to ensure that enough cement is applied to fill the larger gap that exists between the pipe and fittings.
- Ensure the proper selection of cement and primer (refer to Xirtec cement product catalog or your supplier of cements and primers).
- The size of the joining crew should be increased
 - 6" - 8" pipe: 2-3 people per joint
 - 10" - 24" pipe: 3-4 people per joint
- The end of the pipe must be chamfered as per the diagram below.
- The primer and cement should be applied simultaneously to the pipe and fittings.
- Make sure to apply a second full layer of cement to the pipe.
- Because of the short sockets in many large diameter fittings, it is very important to have pipe bottomed into the fitting. It is for this reason that above 6" diameter we recommend the use of a "come-a-long".
- Large diameter pipe and fittings will require longer set and cure times. (In cold weather, a heat blanket may be used to speed up the set and cure times.)
- Prefabricate as many joints as possible.
- If pipe is to be buried, make as many joints as possible above ground, then after the joints have cured, carefully lower the piping system into the trench.

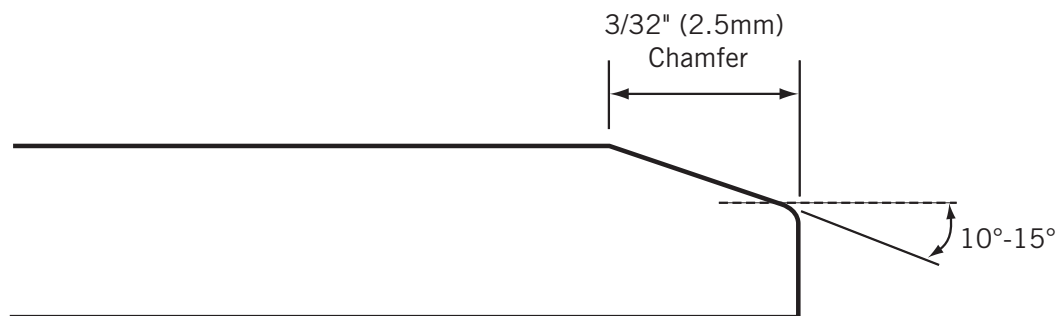

Cold Weather

Although normal installation temperatures are between 40°F (4°C) and 110°F (43°C), high strength joints have been made at temperatures as low as -15°F (-26°C).

In cold weather, solvents penetrate and soften the plastic pipe and fitting surfaces more slowly than in warm weather. In this situation, the plastic is more resistant to solvent attack and it becomes even more important to pre-soften surfaces with an aggressive primer. Be aware that because of slower evaporation, a longer cure time is necessary.

Tips for solvent cementing in cold weather

- Prefabricate as much of the system as is possible in a heated work area.
- Store cements and primers in a warmer area when not in use and make sure they remain fluid.
- Take special care to remove moisture including ice and snow from the surfaces to be joined.
- Ensure that the temperature of the materials to be joined (re: pipe and fittings) is similar.
- Use an IPEX Primer to soften the joining surfaces before applying cement. More than one application may be necessary.
- Allow a longer cure period before the system is used. Note: A heat blanket may be used to speed up the set and cure times.

Hot Weather

There are many occasions when solvent cementing plastic pipe at 95°F (35°C) temperatures and above cannot be avoided. If special precautions are taken, problems can be avoided.

Solvent cements for plastic pipe contain high-strength solvents which evaporate faster at elevated temperatures. This is especially true when there is a hot wind blowing. If the pipe is stored in direct sunlight, the pipe surface temperatures may be 20°F to 30°F (10°C to 15°C) higher than the ambient temperature. In this situation, the plastic is less resistant to attack and the solvents will attack faster and deeper, especially inside a joint. It is therefore very important to avoid puddling the cement inside the fitting socket and to ensure that any excess cement outside the joint is wiped off.

Tips for solvent cementing in hot weather:

- Store solvent cements and primers in a cool or shaded area prior to use.
- If possible, store fittings and pipe or at least the ends to be solvent welded, in a shady area before cementing.
- Try to do the solvent cementing in cooler morning hours.
- Cool surfaces to be joined by wiping with a damp rag.
- Make sure that the surface is dry prior to applying solvent cement.
- Make sure that both surfaces to be joined are still wet with cement when putting them together. With large size pipe, more people on the crew may be necessary.
- Using a primer and a heavier, high-viscosity cement will provide a little more working time.

Note: During hot weather the expansion-contraction factor may increase. Refer to the expansion-contraction design criteria in this manual.

Table 21 – Initial Set Schedule for IPEX and IPEX Recommended PVC/CPVC Solvent Cements *

Temperature Range (°F)	Temperature Range (°C)	Pipe Size (in)				
		½ to 1¼	1½ to 2	2½ to 8	10 to 14	≥ 16
60 to 100	16 to 38	2 minutes	5 minutes	30 minutes	2 hours	4 hours
40 to 60	4 to 16	5 minutes	10 minutes	2 hours	8 hours	16 hours
0 to 40	-18 to 4	10 minutes	15 minutes	12 hours	24 hours	48 hours

* The figures in the table are estimates based on laboratory tests for water applications (chemical applications may require different set times). In damp or humid weather allow 50% more set time.

Note 1: Due to the many variables in the field, these figures should be used as a general guideline only.

Note 2: Initial set schedule is the necessary time needed before the joint can be carefully handled.

Table 22 – Joint Cure Schedule for IPEX and IPEX Recommended PVC/CPVC Solvent Cements *

Temperature Range (°F)	Temperature Range (°C)	Pipe Size (in) & system operating pressure							
		½ to 1¼		1½ to 2		2½ to 8		10 to 14	> 16
		<160 psi	160 - 370 psi	<160 psi	160 - 315 psi	<160 psi	160 - 315 psi	<100 psi	<100 psi
60 to 100	16 to 38	15 min	6 hr	30 min	12 hr	1½hr	24 hr	48 hr	72 hr
40 to 60	4 to 16	20 min	12 hr	45 min	24 hr	4 hr	48 hr	96 hr	6 days
0 to 40	-18 to 4	30 min	48 hr	1 hr	96 hr	72 hr	8 days	8 days	14 days

* The figures in the table are estimates based on laboratory tests for water applications (chemical applications may require different set times). In damp or humid weather allow 50% more cure time (relative humidity over 60%).

Note 1: Due to the many variables in the field, these figures should be used as a general guideline only.

Note 2: Joint cure schedule is the necessary time needed before pressurizing the system.

Table 23 – Average Number of Joints per quart of IPEX and IPEX Recommended Cement *

Pipe Size (in)	No. of Joints / Qt.
½	300
¾	200
1	125
1½	90
2	60
3	40
4	30
6	10
8	5
10	2 - 3
12	1 - 2
14	1

* The figures in the table are estimates based on laboratory tests

Note: Due to the many variables in the field, these figures should be used as a general guideline only.

Table 24 – Average Number of Joints per US gallon of IPEX and IPEX Recommended Cement *

Pipe Size (in)	No. of Joints / Gal.
16	3
18	2
20	1 - 2
24	1

* The figures in the table are estimates based on laboratory tests

Note: Due to the many variables in the field, these figures should be used as a general guideline only.

JOINING METHODS – THREADING

Characteristics

Threading of PVC or CPVC pipe is only recommended for Schedule 80. The wall thickness is diminished at the point of threading and thereby reduces the maximum working pressure by 50%. Because of this, threaded pipe should not be used in high pressure systems nor in areas where a leak might endanger personnel. Threaded joints will not withstand constant or extreme stress and strain and must be supported or hung with this in mind. The threading of pipe sizes above 4" is not recommended.

Note: Using threaded PVC or CPVC products at or near the maximum temperature range should be avoided. Consult IPEX for specific details.

Tools & Equipment

- Power threading machine
- Threading ratchet and pipe vise (if hand pipe stock is used)
- Pipe dies designed for plastic
- Strap wrench
- Teflon* tape (PTFE)
- Cutting and de-burring tool
- Ring gauge (L-1)

*Trademark of the E.I. DuPont Company



Making the Pipe Thread

1. Cutting and Deburring

PVC or CPVC pipe should be cut square and smooth for easy and accurate threading. A miter box or similar guide should be used when sawing is done by hand. Burrs should be removed inside and out using a knife or plastic pipe deburring tool.

2. Threading

Threading Schedule 80 PVC and CPVC pipe can be easily accomplished using either a standard hand pipe stock or a power operated tool. Cutting dies should be clean and sharp.

Power-threading machines should be fitted with dies having a 5° negative front rake and ground especially for plastic pipe. Self opening die heads, and a slight chamfer to lead the dies will speed the operation; however, dies should not be driven at high speeds or with heavy pressure.

When using a hand-held cutter, the pipe should be held in a pipe vise. To prevent crushing or scoring of the pipe by the vise jaws, some type of protective wrap such as canvas, emery paper, rubber or light metal sleeve should be used.

For hand stocks, the dies should have a negative front rake angle of 5° to 10°. PVC and CPVC is readily threaded and caution should be taken not to over-thread. This procedure is best done in a shop or fabricating plant. Thread dimensional specifications can be found in Table 25, American National Standard Taper Pipe Threads (NPT).

Installation Guidelines

1. Preparing the Threaded Pipe

A ring gauge should be used to check the accuracy of the threads.

Tolerance = $\pm 1\frac{1}{2}$ turns.

The threads should be cleaned by brushing away cuttings and ribbons. After cleaning, apply an IPEX recommended thread lubricant such as Teflon® tape (PTFE) or IPEX Thread Sealant to the threaded portion of the pipe.

If tape is used, wrap the tape around the entire length of threads beginning with number two thread from the end. The tape should slightly overlap itself going in the same direction as the threads. This will prevent the tape from unraveling when the fitting is tightened on the pipe. Overlapping in the wrong direction and the use of too much tape can affect tolerances between threads. This can generate stress in the wall of female fittings resulting in failure during operations.



If IPEX Thread Sealant is to be used, brush on a generous amount of sealant, using the correctly sized applicator, onto the threads beginning with the number two thread from the end.

Note: IPEX strongly recommends the use of IPEX Pipe Thread Compound (or other IPEX approved sealants) when connecting threaded fittings to other materials.

IPEX Pipe Thread Compound has been specifically formulated for use with thermoplastic piping systems. Use of other sealants may contain substances harmful to thermoplastics.

2. Assembly of Threaded Joints and Unions

After applying thread lubricant, screw the threaded fitting onto the pipe. Screwed fittings should be started carefully and hand tightened. Threads must be properly cut and a good quality thread lubricant/tape must be used. If desired, the joint may be tightened with a strap wrench. In NO INSTANCE should a pipe or chain wrench be used as the jaws of this type of wrench will scar and damage the pipe wall.

Fittings should be threaded together until hand tight with an additional $\frac{1}{2}$ to 1 turns more. Avoid stretching or distorting the pipe, fittings or threads by over tightening.



Note 1: Never apply solvent cement to threaded pipe or threaded fittings. Do not allow cleaners, primers, or solvent cements to “run” or drip into the threaded portion of the fitting.

Note 2: Avoid screwing metallic male threads into plastic female threads, except those that have metal reinforcement. Consult the factory or your IPEX sales representative for the availability of these metal reinforced fittings.

Note 3: It is recommended that pipe tape/lubricant be used when connecting union ends to threaded pipe. However, pipe tape/lubricant is not needed on the union threaded interface assembly.

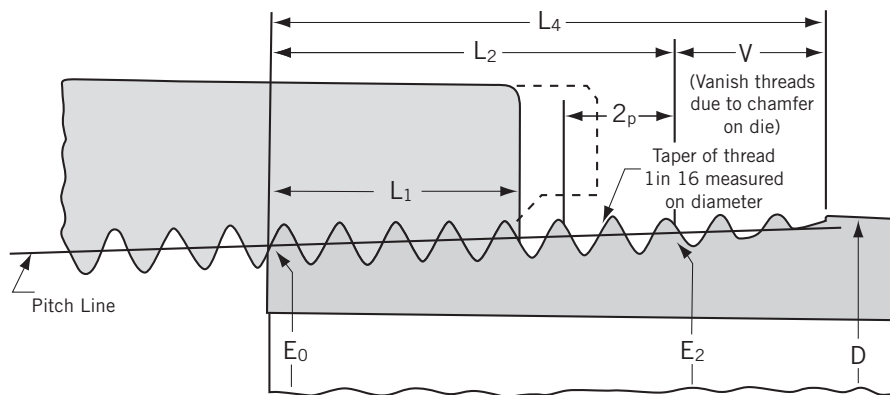

Table 25 - American National Standard Taper Pipe Threads (NPT)

Nominal Pipe Size	O.D. of Pipe (D)	Threads per inch (n)	Pitch of Thread (P)	Pitch Diameter at Beginning of External Thread (E_0)	Handtight Engagement		Effective Thread, External		Vanish Thread (V)		Overall Length External Thread ⁴ (L_4)	Height of Thread (h)
					Length ² (L_1)		Length ³ (L_2)		Thread			
					Inch	Threads	Inch	Threads	Inch	Thread		
1/8	0.405	27	0.03704	0.36351	0.1615	4.36	0.2639	7.12	0.1285	3.47	0.3924	0.02963
1/4	0.540	18	0.05556	0.47739	0.2278	4.10	0.4018	7.23	0.1928	3.47	0.5946	0.04444
3/8	0.675	18	0.05556	0.61201	0.240	4.32	0.4078	7.34	0.1928	3.47	0.6006	0.04444
1/2	0.840	14	0.07143	0.75843	0.320	4.48	0.5337	7.47	0.2478	3.47	0.7815	0.05714
3/4	1.050	14	0.07143	0.96768	0.339	4.75	0.5457	7.64	0.2478	3.47	0.7935	0.05714
1	1.315	11.5	0.08696	1.21363	0.400	4.60	0.6828	7.85	0.3017	3.47	0.9845	0.06957
1 1/4	1.660	11.5	0.08686	1.55713	0.420	4.83	0.7068	8.13	0.3017	3.47	1.0085	0.06957
1 1/2	1.900	11.5	0.08696	1.79609	0.420	4.83	0.7235	8.32	0.3017	3.47	1.0252	0.06957
2	2.375	11.5	0.08696	2.26902	0.436	5.01	0.7565	8.70	0.3017	3.47	1.0582	0.06957
2 1/2	2.875	8	0.12500	2.71953	0.682	5.46	1.1375	9.10	0.4337	3.47	1.5712	0.100000
3	3.500	8	0.12500	3.34062	0.766	6.13	1.2000	9.60	0.4337	3.47	1.6337	0.100000
3 1/2	4.000	8	0.12500	3.83750	0.821	6.57	1.2500	10.00	0.4337	3.47	1.6837	0.100000
4	4.500	8	0.12500	4.33438	0.844	6.75	1.3000	10.40	0.4337	3.47	1.7337	0.100000
5	5.563	8	0.12500	5.39073	0.937	7.50	1.4063	11.25	0.4337	3.47	1.8400	0.100000
6	6.625	8	0.12500	6.44609	0.958	7.66	1.5125	12.10	0.4337	3.47	1.9462	0.100000

NOTE:

- The basic dimensions of the American National Standard Taper Pipe Thread are given in inches to four or five decimal places. While this implies a greater degree of precision than is ordinarily attained, these dimensions are the basis of gage dimensions and are so expressed for the purpose of eliminating errors in computations.
- Also length of thin ring gage and length from gaging notch to small end of plug gage.
- Also length of plug gage.
- Reference dimension

JOINING METHODS – FLANGING

Introduction

Flanging is used extensively for plastic process lines that require periodic dismantling. Thermoplastic flanges and factory flanged fittings in PVC and CPVC are available in a full range of sizes and types for joining to pipe by solvent welding and threading. Gasket seals between the flange faces should be an elastomeric full-faced gasket with a hardness of 50 to 70 durometer A. Neoprene gaskets are commonly available in sizes from 1/2" through to 24" range having a 1/8" thickness. For chemical environments beyond the capabilities of neoprene, more resistant elastomers should be used.

Dimensions

IPEX PVC and CPVC flanges have the same bolt hole dimensions as Class 150 metal flanges per ANSI B16.5. Threads are tapered iron pipe size threads per ANSI B2.1. The socket dimensions conform to ASTM D 2467 which describes 1/2" through 8". Flanges 1/2" to 12" are third party tested by NSF according to ASTM F 1970. Flange bolt sets are listed in Table 28.

Maximum pressure for any flanged system is the rating of the pipe or up to 150 psi. Maximum operating pressures for elevated temperatures are shown in Table 26. To elevate the pressure rating above 150psi, a full-pressure flange kit is available. Details on page 58.

Blind flanges in sizes 14" – 24" have a maximum working pressure of 50 psi.

Table 26 - Maximum Pressures for Flanged Systems

Operating Temp.		Max. Operating Pressure (psi)	
°F	°C	PVC	CPVC
73	23	150	150
80	27	132	144
90	32	113	137
100	38	93	123
110	43	75	111
120	49	60	98
130	54	45	87
140	60	33	75
150	66	*	68
160	71	*	60
170	77	*	50
180	82	*	38
200	93	NR	30
210	99	NR	*

* intermittent drainage only
NR – not recommended



Installation Guidelines

The faces of IPEX flanges have a phonographic-grooved finish providing positive seal on the gasket when the bolts are properly tightened.

Once a flange is joined to pipe, use the following method to join two flanges together:

- 1) Make sure all bolt holes of the matching flanges are aligned.
- 2) Insert all bolts.
- 3) Make sure the faces of the mating flanges are not separated by excessive distance prior to bolting down the flanges.
- 4) The bolts on the plastic flanges should be tightened by pulling down the nuts diametrically opposite each other using a torque wrench. Complete tightening should be accomplished in stages using the final torque values in Table 27, Recommended Torque. Uniform stress across the flange will eliminate leaky gaskets.

The following tightening pattern is suggested for the flange bolts.

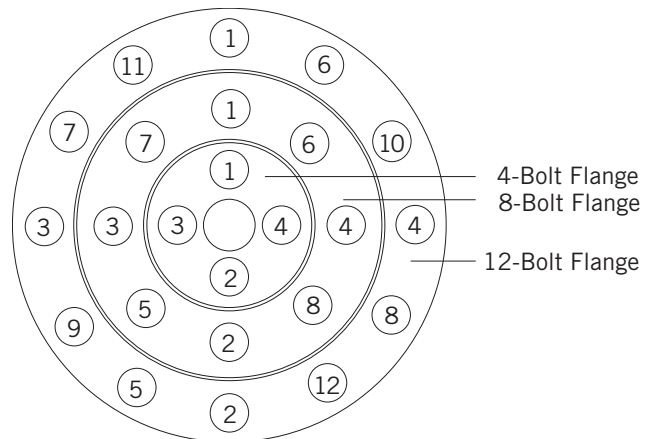

- 5) If the flange is mated to a rigid and stationary flanged object or a metal flange, particularly in a buried situation where settling could occur with the plastic pipe, the plastic flange, and fitting or valve must be supported to eliminate potential stressing.

Table 27 – Recommended Torque

Flange Size (in.)	Recommended Maximum Torque Full Face/Heavy Duty Vanstone	PVC Vanstone
1/2– 1-1/2	15	15
2 – 4	30	30
6 – 8	50	50
10	70	65
12 – 24	100	75

* Based on using flat-faced PVC and CPVC flanges, a full-faced neoprene gasket, and well lubricated hardware, tightened in the proper sequence and applying torque in small increments. For vinyl-to-metal flange (or other materials), these torque recommendations may vary. Vanstone HD flanges should be tightened with the same torque as flat faced flanges.

Note: When thermoplastic flanges with PVC rings are used with butterfly valves or other equipment where a full-faced continuous support does not exist, a back-up ring or fiberloc ring should be used to prevent potential cracking of the flange face.

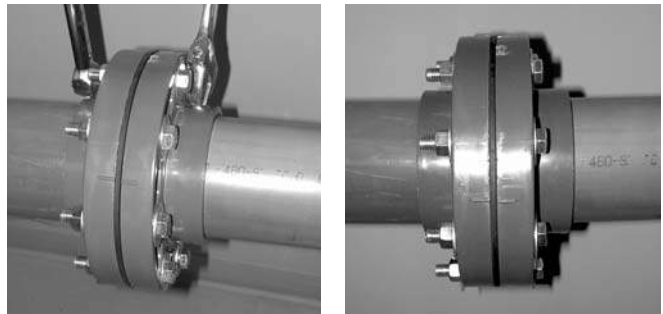

Table 28 - Recommended Flange Bolt Set

Pipe Size	No. of Holes	Bolt Diameter	Bolt Length
1/2	4	0.50	1.75
3/4	4	0.50	2.00
1	4	0.50	2.00
1-1/4	4	0.50	2.25
1-1/2	4	0.50	2.50
2	4	0.63	2.75
2-1/2	4	0.63	3.00
3	4	0.63	3.00
4	8	0.63	3.25
6	8	0.75	3.50
8	8	0.75	4.00
10	12	0.88	5.00
12	12	0.88	5.00
14	12	1.00	7.00
16	16	1.00	7.00
18	16	1.13	8.00
20	20	1.13	9.00
24	20	1.25	9.50

* Bolt length may vary depending on the style of flange and use of backing rings.

CAUTION

1. Do not over-torque flange bolts.
2. Use the proper bolt tightening sequence.
3. Make sure the system is in proper alignment.
4. Flanges should not be used to draw piping assemblies together.
5. Flat washers must be used under every nut and bolt head.



Corzan® Full Pressure Flange Kit

- One (1) Two-piece steel backing ring
- One (1) Stress-Saver XP gasket (75-80 durometer hardness)
- SAE J429 Grade 8 bolts with associated hex nut
- Two flat washers per bolt
- One (1) Corzan CPVC one-piece socket flange



Not shown; receiving flange between gasket and washer

IPEX is pleased to announce the launch of our new Corzan® Full Pressure (FP) Flange Kits, specifically developed to increase the pressure capability of a Schedule 80 Iron Pipe Size (IPS) Corzan CPVC one-piece flange. The Corzan FP Flange Kits have a pressure rating equal to that of Schedule 80 Corzan CPVC pipe in each of the 4 sizes offered (2-1/2" through 6"). The pressure rating is valid for connections to solid flat face metal flanges or to a second Corzan FP Flange Kit. The flange kit assembly is NSF 14 listed and meets the requirements set forth by the American Society of Testing Materials (ASTM) F1970. The special gasket and IPEX Corzan CPVC one-piece flange contained within this kit are certified to ANSI/NSF Standard 61.

Elevated Temperature Limitations

For IPEX Corzan CPVC Full-Pressure flange kits, the average pressure system operating temperature ranges from 40°F (4°C) to 200°F (93°C). At elevated temperatures the pressure capabilities of a Full-Pressure flange kit joint must not exceed the values as detailed below.

Pressure Capabilities of a Full-Pressure Flange Kit Joint

Operating Temperature		Size			
°F	°C	2-1/2"	3"	4"	6"
73	23	420	370	320	280
80	27	403	355	307	269
90	32	382	337	291	255
100	38	344	303	262	230
110	43	311	274	237	207
120	49	273	241	208	182
130	54	244	215	186	162
140	60	210	185	160	140
150	66	189	167	144	126
160	71	168	148	128	112
170	77	139	122	106	92
180	82	105	93	80	70
200	93	84	74	64	56
212	100	*	*	*	*

* Recommended for intermittent drainage only

Installation Instructions for Corzan Full-Pressure Flange Kits

Background

Proper installation of this product, for mating with a metal flange, requires the use of all the components supplied to achieve a pressure rating equal to that of the pipe.

Kit Contents

- Two-Piece steel backing ring
- Stress-Saver XP gasket (75-80 Durometer Hardness)
- SAE J429 Grade 8 bolts with associated hex nut*
- Two (2) flat washers per bolt
- Corzan CPVC one-piece socket flange

***Note:** the bolt length will vary for flange size and assembly configuration. The length of bolts supplied in this kit is assuming connection to a metal flange. For Corzan to Corzan flange connections, bolts should be 1/2" longer so that the bolts extend approximately 1/4" minimum beyond the nut after final assembly.

Installers will also need a torque wrench for proper assembly.

Installation Procedure

1. Assemble a Corzan flange to a Corzan pipe in a normal manner with proper solvent welding procedures in accordance with solvent cement installation procedures detailed in the Vinyl Process Piping Systems Technical Manual.
2. Allow the joint to fully cure set before installing the remaining components of the Full-Pressure Kit (refer to page 53 for recommended cure times versus temperature and size).
3. Begin kit installation by placing the backing ring over the back of the hub of the Corzan flange, ensuring that the bolt holes are aligned.
4. Slip the gasket provided between the two flanges and bring the Corzan and mating flanges together.
5. Insert the bolts through the matching holes of both the flanges and backing ring. Use only the bolts supplied or recommended above. A flat washer should be installed beneath each nut and the bolt head.
6. When the bolts are installed, a torque wrench should be placed over the nut (not on bolt head). Snug tighten the nut first, which is approximately 20 ft-lb of torque.

- Next, tighten the nuts to the specified torque values indicated below (Table XXX). A multi-step tightening process is recommended with each step requiring the installer to tighten the nuts in a star pattern (Figure XXX).

TORQUE (ft-lbs)

TABLE 1

Size	Step 1	Step 2	Step 3	Step 4
2-1/2"	20	40	70	—
3"	20	40	70	—
4"	20	40	80	110
6"	20	40	80	110

TIGHTENING SEQUENCE

FIGURE 1

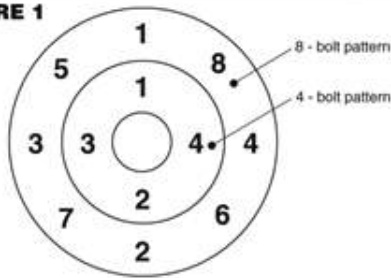

- Once this assembly is complete, perform a check pass of the bolts by starting at one and going around in a clockwise direction ensuring each nut is tightened to the highest recommended torque level for that size.
- Do not use the flanged connection to support the weight of a metal system component such as a ball or butterfly valve. Those items should be supported independently.**

Notes:

- After the piping is installed, and the solvent cement is fully cured, the system should be pressure-tested in accordance with local codes using water. Do not use compressed air or gases for testing. Refer to the Vinyl Process Piping Technical Manual for further instructions on testing.
- Flange kits cannot be installed against mating surfaces that include an integrated gasket, like wafer-style butterfly valves. The gasket provided in the Full-Pressure Flange Kit must be the only gasket used in the assembly.**
- This Flange assembly has been certified to ASTM F 1970. As such, any components that are replaced must comply with the listing I order to maintain the certification. Replacement parts shall be: Stress-Saver XP gasket (75-80 Durometer Hardness), SAE J429 Grade 8 bolts with associated hex nut, two (2) flat washers per bolt.

Note: the bolt length will vary for flange size and assembly configuration. The length of bolts supplied in this kit is assuming connection to a metal flange. For Corzan to Corzan flange connections, bolts should be 1/2" longer so that the bolts extend approximately 1/4" minimum beyond the nut after final assembly.

WARNING



Failure to install flange properly may result in joint leakage or joint failure which may cause severe injury and property damage.

CAUTION

- Do not over-torque flange bolts.
- Use the proper bolt tightening sequence.
- Make sure the system is in proper alignment.
- Flanges should not be used to draw piping assemblies together.
- Flat washers must be used under every nut and bolt head.

JOINING METHODS – ROLL GROOVED OR RADIUS CUT GROOVED (PVC ONLY)

Introduction

IPEX PVC pipe can be roll or cut-grooved at each end for quick connection using mechanical couplings specifically designed for PVC pipe. This method can be used in any application where PVC pipe is acceptable and where it is desirable to have a means for quick assembly under adverse conditions.

Features

- Completely re-usable pressure system that does not require threading, solvent welding, or flanging.
- Joints are mechanically locked to produce a secure, leak-tight connection under pressure or vacuum. (See coupling manufacturer's product information for details on pressure capabilities.)
- A union at every joint allows for speed and ease of assembly and field maintenance.
- In abrasive applications, pipe can easily be rotated to distribute wear evenly.
- Flexible system permits laying on rough or uneven terrain.
- When using a gasket-type coupler, each joint will absorb some expansion and contraction due to temperature changes.
- Grooved systems facilitate fast add-ons, modifications or re-location of the pipe.



Table 29 – Recommended Piping for Roll or Radius Cut Grooved Joints

Piping Material	Recommended Grooved Joints
PVC Sch 40 (2" – 8")	Roll or radius cut
PVC Sch 80 (2" – 12")	Roll or radius cut
PVC SDR 26 (6" – 12")	Roll or radius cut
PVC SDR 21 (4" – 12")	Roll or radius cut
PVC 14"	* May be cut grooved
PVC 16"	* May be cut grooved
PVC 18"	* May be cut grooved
PVC 24"	* May be cut grooved

* Consult an IPEX representative for detailed design considerations

Installation Guidelines

- 1) Always use a grooved coupling that is designed and recommended for use with PVC pipe. Table 29 shows recommended piping systems for above ground assemblies.
- 2) The grooves are normally machined or rolled in the pipe end by IPEX before shipment. The dimensions of the groove will be as recommended by the grooved coupling manufacturer as shown in Table 30, Grooved Joint Dimensions.
- 3) The working pressure and/or test pressure in a grooved joint PVC piping system should not exceed the recommended maximum pressures shown in Table 31, Maximum Pressures for Grooved PVC Pipes, at temperatures at or below 73°F (23°C).
- 4) The maximum recommended operating pressures in Table 31 should be multiplied by the factors in Table 32, Temperature De-rating Factors for Grooved Joints, when the system works at temperatures constantly above 73°F (23°C). The maximum recommended operating temperature in grooved-jointed PVC pipe systems is 100°F (38°C).
- 5) The installation of grooved-jointed PVC pipe should ensure that:
 - a) Thrust reaction is restrained at points of deflection or dead ends by external supports or harnesses. Thrust forces should not be transferred to the joints by design.
 - b) Straight alignment of pipe is maintained at the joints, using a suitable support system.
 - c) Thermal expansion/contraction movement does not exceed .0625" per joint.

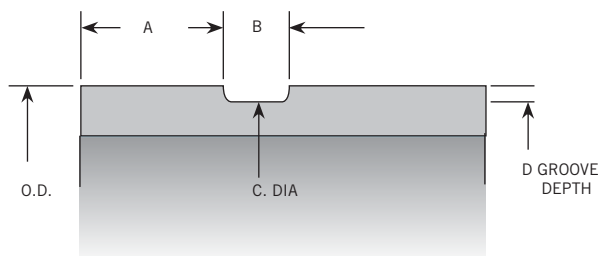

Table 30 – Grooved Joint Dimensions

Pipe Size (in.)	O.D. (in.)	A ± 0.031 (in.)	B ± 0.031 (in.)	C Average (in.)	D* (in.)
2	2.375	0.625	0.312	2.250 ± 0.015	0.062
2½	2.875	0.625	0.312	2.720 ± 0.018	0.078
3	3.500	0.625	0.312	3.344 ± 0.018	0.078
4	4.500	0.625	0.375	4.334 ± 0.020	0.083
6	6.625	0.625	0.375	6.455 ± 0.022	0.085
8	8.625	0.750	0.437	8.441 ± 0.025	0.092
10	10.750	0.750	0.500	10.562 ± 0.027	0.094
12	12.750	0.750	0.500	12.531 ± 0.030	0.109

* Dimension D is a convenient reference only, dimension C governs

Table 31 – Maximum Pressures (psi) for Cut Grooved PVC Pipes at 73°F

Pipe Size (in.)	SDR 26	SDR 21	SCH 40	SCH 80
2	-	-	100	170
2½	-	-	110	175
3	-	-	100	160
4	-	75	85	140
6	60	80	70	125
8	65	85	65	115
10	70	90	-	110
12	70	90	-	110

Table 32 – Temperature De-rating Factors for Grooved Joints

Operating Temp.		De-rating Factor
°F	°C	
73	38	1.00
80	27	0.90
90	32	0.75
*100	38	0.62

* Maximum recommended operating temperature for grooved PVC piping systems.

SUPPORTS AND RESTRAINTS

Thrust

Thrust forces can occur at any point in a piping system where the directional or cross-sectional area of the waterway changes or where additional structural loads such as valves are installed. These forces must be reduced by means of anchors, risers, restraining hangers, thrust blocks or encasement. The method chosen will depend on whether the system is buried or above ground. See also the section on installation of buried pipes in this manual.

The size or need for reinforcements should be based on the design engineer's evaluation of flow velocities and pressure increases due to the fluid's momentum. Note that the thrust created at unrestrained fittings can be considerable (as shown in Table 33) and should be addressed during installation. For more detail regarding estimating and compensating for thrust forces, refer to engineering textbooks such as the *Uni-Bell Handbook of PVC Pipe*.

Note that all valves must be anchored. This includes valves installed in line, in a chamber and those that are operated infrequently. It is recommended that anchor rods be installed around the valve body or through the mounting lugs. The rods should be embedded in concrete beneath the valve.

Table 33 - Thrust at Fittings in pounds Per 100 psi (internal pressure)

Pipe Size (in)	Blank ends & junctions	90° Bends	45° Bends	22½° Bends	11¼° Bends
½	60	85	50	25	15
¾	90	130	70	35	20
1	140	200	110	55	30
1¼	220	320	170	90	45
1½	300	420	230	120	60
2	450	630	345	180	90
2½	650	910	500	260	130
3	970	1,360	745	385	200
4	1,600	2,240	1,225	635	320
6	3,450	4,830	2,650	1,370	690
8	5,850	8,200	4,480	2,320	1,170
10	9,100	12,750	6,980	3,610	1,820
12	12,790	17,900	9,790	5,080	2,550
14	15,400	21,500	11,800	6,100	3,080
16	20,100	28,150	15,400	7,960	4,020
18	25,400	35,560	19,460	10,060	5,080
20	31,400	43,960	24,060	12,440	6,280
24	45,300	63,420	34,700	17,940	9,060

General Principles of Support

Adequate support for any piping system is a matter of great importance. In practice, support spacing is a function of pipe size, operating temperatures, the location of heavy valves or fittings and the mechanical properties of the pipe material.

To ensure satisfactory operation of a thermoplastic piping system, the location and type of hangers should be carefully considered. The principles of design for steel piping systems are generally applicable to thermoplastic piping systems, but with some notable areas where special consideration should be exercised.

- 1) Concentrated loads (i.e. valves, flanges, etc.) should be supported directly to eliminate high stress concentrations on the pipe. Should this be impractical, the pipe must then be supported immediately adjacent to the load.
- 2) In systems where large fluctuations in temperature occur, allowance must be made for expansion and contraction of the piping system. Since changes in direction in the system are usually sufficient to allow expansion and contraction, hangers must be placed so movement is not restricted. (See also Expansion-Contraction in the Design section in this manual). Note that in some instances it may be desirable to use a clamp-type hanger to direct thermal expansion or contraction in a specific direction. When using a clamp-type hanger, the hanger should not deform the pipe when it has been tightened. (See Figure 9, Recommended Pipe Hangers)
- 3) Changes in direction (e.g. 90° elbows) should be supported as close as practical to the fitting to avoid introducing excessive torsional stresses into the system.
- 4) Since PVC and CPVC pipe are somewhat notch sensitive, hangers should provide as much bearing surface as possible. Sharp supports or sharp edges on supports should not be used with these materials since they will cause mechanical damage if the pipe moves.
- 5) Valves should be braced against operating torque. Heavy metal valves should be supported so as not to induce additional stress on the thermoplastic piping system.

Tables 34 and 35 give recommended maximum support spacing for PVC and CPVC pipe at various temperatures. The data is based on fluids with a specific gravity of 1.0. For heavier fluids, the support spacing from the graphs should be multiplied by the correction factors shown in Table 36.

These maximum recommendations should always be referenced against local plumbing and mechanical codes as well as the local authority having jurisdiction.

Supporting Pipes

The high coefficient of thermal expansion of plastic compared with metals may result in considerable expansion and contraction of the pipe runs as the temperature changes.

The principle is to control expansion by restraining the pipe in the lateral direction while allowing free axial movement.

A hanger-type support does not provide lateral restraint to the pipe, but it does encourage snaking and should be avoided whenever possible.

The diagram below illustrates preferred and non-preferred support arrangements.

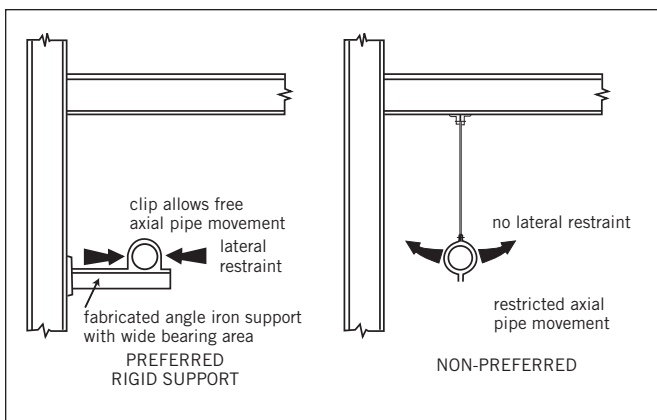

In some cases, it may be physically impossible or impractical to install a rigid support in between two widely spaced columns. In this event hanger rods with loose fitting clips should be used.

The frequency of supports for plastic pipes is greater than for metal pipes. The recommended maximum distance between supports for pipes filled with water is given in Table 34 (See Recommended Maximum Support Spacing) and applies to pipes and contents at the temperature stated.

Pipe supports should be installed so that the horizontal piping is in uniform alignment and with a uniform slope of at least 1/8" per foot, or in accordance with the local plumbing codes or authority having jurisdiction.

Calculation of Support Spacing Based on Sag Limit

$$L = \frac{[(SL \times E \times I) / (1.302 \times Wt)]^{0.333}}{12}$$

Where:

L = Length between supports, 'Span Length', Ft.

SL = Sag Limit, the maximum permitted vertical deflection allowed across a span, expressed as a percentage of the span length for 0.2% SL = 0.2

E = Modulus of elasticity of the pipe material, psi (see Table 15)

OD = Outside Diameter of the pipe, ins.

$$I = \frac{\pi}{64} \times (OD^4 - ID^4)$$

$$Wt = 0.02837 \times (\delta\text{-pipe} \times (OD^2 - ID^2) + \delta\text{-fluid} \times ID^2)$$

$\delta\text{-pipe}$ = Density of pipe material, g/cc = Specific Gravity x 0.9975

$\delta\text{-fluid}$ = Density of the fluid, g/cc

ID = Inside diameter of the pipe, ins

Example 17

For a 1½" Schedule 40 PVC pipe operating at 140°F (60°C), calculate the maximum allowable support spacing with a sag limit of 0.2% (System fluid density = 1.0 g/cc)

Step 1: Calculate the weight of the piping system

$$Wt = 0.02837 \times (\delta\text{-pipe} \times (OD^2 - ID^2) + \delta\text{-fluid} \times ID^2)$$

Known:

Specific gravity of PVC = 1.42 (from Table 1)

E = Modulus of elasticity = 280,000 psi

OD = 1.900" (from Table A-14)

$\delta\text{-pipe}$ = 1.42 x 0.9975 = 1.416 g/cc

ID = 1.590" (from Table A-14)

$$wt = 0.02837 \times (1.416 \times (1.900^2 - 1.590^2) + 1.0 \times 1.590^2)$$

$$wt = 0.11518$$

Step 2: Calculate the moment of inertia

$$I = \frac{\pi}{64} \times (1.900^4 - 1.590^4)$$

$$I = 0.326$$

Step 3: Calculate the maximum allowable support spacing

$$L = \frac{[(0.2 \times 280,000 \times 0.326) / (1.302 \times 0.11518)]^{0.333}}{12}$$

$$L = 4.114 \text{ ft.}$$

Table 34 – Recommended Maximum Support Spacing in feet for Xirtec140 PVC *

Pipe Size (in.)	Schedule 40 PVC			Schedule 80 PVC		
	60°F (15°C)	100°F (38°C)	140°F (60°C)	60°F (15°C)	100°F (38°C)	140°F (60°C)
1/2	3.0	2.9	2.6	3.1	3.0	2.7
3/4	3.4	3.2	3.0	3.5	3.4	3.1
1	3.9	3.7	3.4	4.0	3.9	3.6
1 1/4	4.3	4.2	3.9	4.6	4.4	4.1
1 1/2	4.7	4.5	4.1	5.0	4.8	4.4
2	5.2	5.0	4.6	5.6	5.4	5.0
3	6.7	6.4	5.9	7.2	6.9	6.4
4	7.6	7.3	6.7	8.2	7.9	7.3
6	9.2	8.9	8.2	10.3	9.9	9.2
8	10.7	10.2	9.5	12.0	11.5	10.6
10	12.0	11.5	10.7	13.7	13.1	12.1
12	13.2	12.7	11.8	15.2	14.6	13.5
14	14.0	13.5	12.4	16.2	15.6	14.4
16	15.3	14.7	13.6	17.6	16.9	15.7
18	16.6	15.9	14.7	19.0	18.3	16.9
20	17.5	16.8	15.5	20.0	19.5	18.1
24	19.6	18.8	17.4	20.0	20.0	20.0

* based on a sag limit of 0.2% of span length that is well within the bending stress limits of the material. This conservative calculation is also intended to accommodate expansion and contraction, pressure surges and entrapped air.

Note 1: A maximum span of 20 ft. is recommended.

Note 2: Bearing surface of supports should be at least 2" wide.

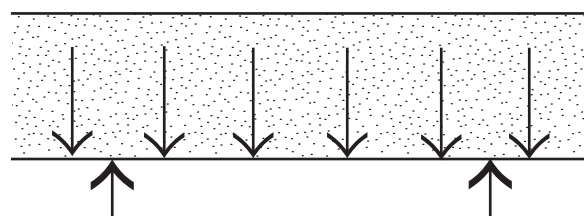

Assume the load is uniformly distributed along the span length

Table 35 – Recommended Maximum Support Spacing in feet for Corzan CPVC *

Pipe Size (in.)	Schedule 80 CPVC						
	73°F (23°C)	100°F (38°C)	120°F (49°C)	140°F (60°C)	160°F (71°C)	180°F (82°C)	200°F (92°C)
½	3.1	3.0	2.9	2.8	2.7	2.7	2.5
¾	3.5	3.4	3.3	3.2	3.1	3.0	2.8
1	4.1	3.9	3.8	3.7	3.6	3.5	3.3
1¼	4.6	4.5	4.4	4.2	4.1	4.0	3.7
1½	5.0	4.8	4.7	4.6	4.4	4.3	4.0
2	5.6	5.5	5.3	5.2	5.0	4.9	4.5
2½	6.5	6.3	6.1	5.9	5.7	5.6	5.2
3	7.2	7.0	6.8	6.6	6.4	6.2	5.8
4	8.3	8.1	7.8	7.6	7.4	7.1	6.7
6	10.4	10.1	9.8	9.5	9.2	9.0	8.4
8	12.1	11.7	11.4	11.0	10.7	10.4	9.7
10	13.8	13.4	13.0	12.6	12.3	11.9	11.1
12	15.4	15.0	14.5	14.1	13.7	13.3	12.4
14	16.4	15.9	15.4	15.0	14.5	14.1	13.2
16	17.8	17.3	16.8	16.3	15.4	14.9	14.3

Pipe Size (in.)	Schedule 40 CPVC						
	73°F (23°C)	100°F (38°C)	120°F (49°C)	140°F (60°C)	160°F (71°C)	180°F (82°C)	200°F (92°C)
½	3.0	2.9	2.8	2.7	2.7	2.6	2.4
¾	3.4	3.3	3.2	3.1	3.0	2.9	2.7
1	3.9	3.8	3.7	3.5	3.4	3.3	3.1
1¼	4.4	4.3	4.1	4.0	3.9	3.8	3.5
1½	4.7	4.6	4.4	4.3	4.2	4.0	3.8
2	5.3	5.1	5.0	4.8	4.7	4.5	4.2
2½	6.1	5.9	5.7	5.6	5.4	5.2	4.9
3	6.7	6.5	6.3	6.1	6.0	5.8	5.4
4	7.7	7.4	7.2	7.0	6.8	6.6	6.2
6	9.4	9.1	8.8	8.6	8.3	8.1	7.5
8	10.8	10.5	10.2	9.9	9.6	9.3	8.7
10	12.2	11.8	11.5	11.1	10.8	10.5	9.8
12	13.4	13.0	12.7	12.3	11.9	11.5	10.6
14	14.2	13.8	13.4	13.0	12.6	12.2	11.3
16	15.5	15.1	14.6	14.2	13.8	13.4	12.1

*based on a sag limit of 0.2% of span length.

Note 1: Greater than 200°F requires continuous support.

Note 2: Bearing Surface of supports should be at least 2" wide.

Table 36 – Support Spacing Correction Factors

Specific Gravity	1.0	1.1	1.2	1.4	1.6	2.0	2.5
Correction Factor	1.00	0.98	0.96	0.93	0.90	0.85	0.80

When the fluid has a specific gravity greater than water (1.0) the hanging distance must be decreased by multiplying the recommended support distance by the appropriate correction factor.

Figure 9 – Recommended Pipe Hangers for Thermoplastic Piping Systems

Pipe Rings

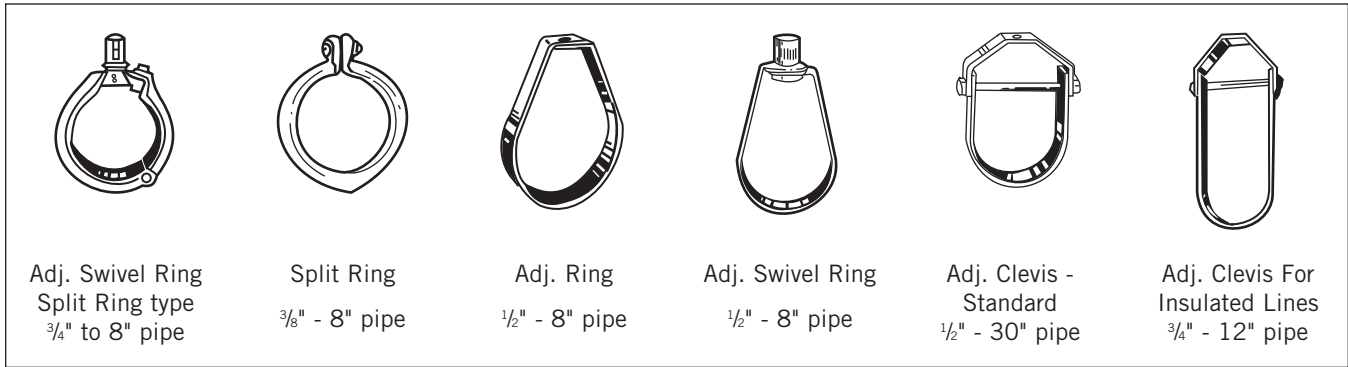

Pipe Rolls

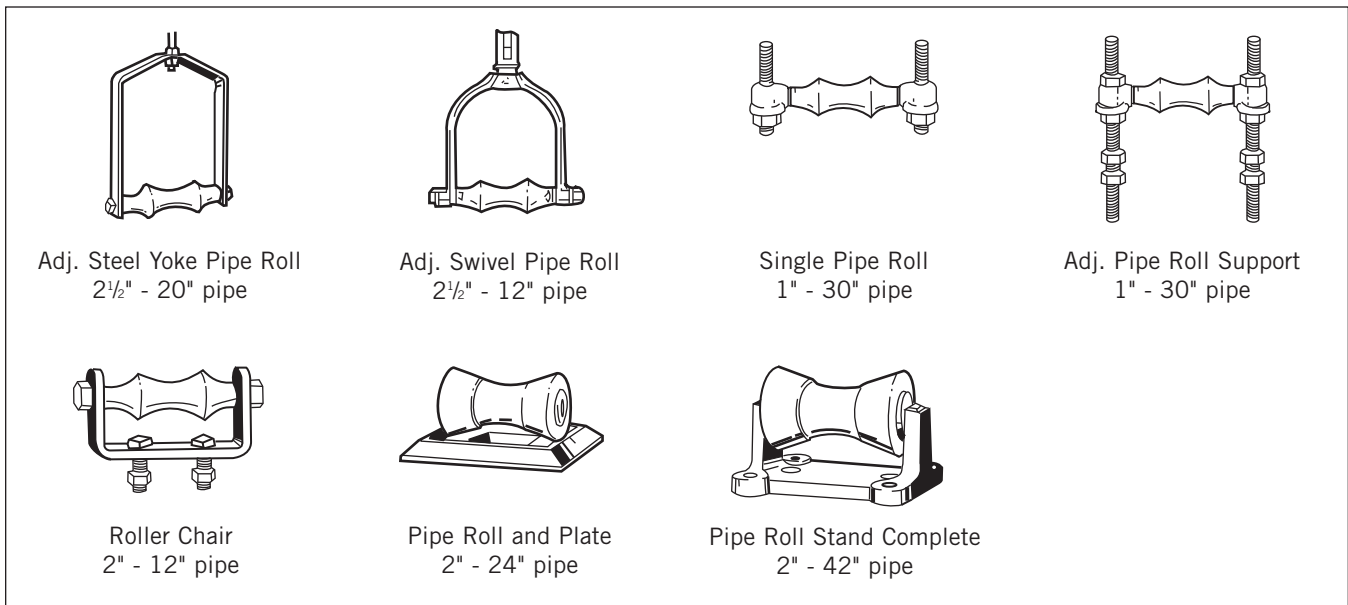

INSTALLATION

Pipe Straps and Hooks

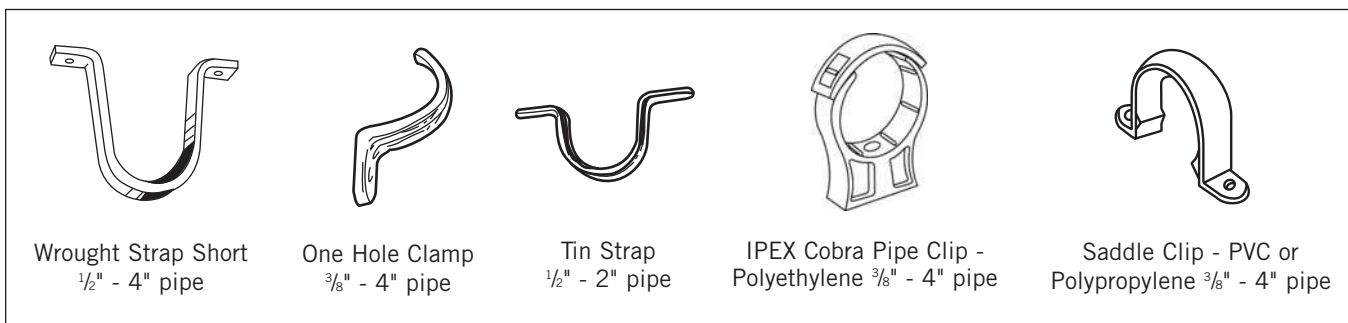

Pipe Clips

All pipe clips should permit free axial pipe movement at all temperatures and should provide adequate bearing support to the pipe. Metal clips and supports should be free of sharp edges to prevent damaging the pipe.

Pipe Clamps



Pipe Clamp Medium
1/2" - 24" pipe

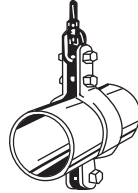

Double Bolt Pipe Clamp
3/4" - 36" pipe

Pipe Covering



Insulation Protection Shield
1/2" - 24" pipe

Bolt

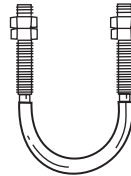

U Bolt*
Standard: 1/2" - 30" pipe
Light Weight: 1/2" - 10" pipe

*Also available
plastic coated.

Note: Clamps used as anchors (such as U-bolts, etc.), if over-tightened, can produce a point-of-load stress on the pipe. This can result in cracking or premature burst failure. If U-bolts must be used, then a metal shield should be placed between the U-bolt and pipe surface. When anchoring plastic pipe, it is always desirable to spread the load over a wide area of contact.

INSTALLATION OF BURIED PIPES

Introduction

All buried piping systems are subjected to both internal and external loads. Internal loading is related to the requirements of the medium being carried and the material properties of the pipe as discussed previously in the Design section. For external loads, vinyl pipe is considered flexible (able to bend without breaking) and uses the pipe wall and the surrounding soil medium to support external loads. In other words, the soil and pipe form an integral structure. Depending on the loading characteristics, the pipe will either deflect or compress.

The external loads that need to be determined are earth, static and dynamic. Detail on determining external load characteristics is beyond the scope of this manual. For further information on determining load characteristics, the user is directed to other engineering textbooks such as the Uni-Bell Handbook of PVC Pipe.

Trench Preparation

Engineering documents for a project will specify the correct line and grade for the trench, however it is important to keep a few things in mind during the trenching operation.

Although the width at the top of the trench is generally dictated by local conditions, the width in the pipe zone should be as narrow as practical. The general rule is that the maximum width at the top of the pipe should not be more than the outside diameter of the pipe plus 24 inches. If trench width cannot be controlled and will exceed the maximum, then compacted backfill must be provided for a distance of 2½ pipe diameters on either side of the pipe to the trench wall for pipe sizes up to 10 inches. For larger size pipe (14" to 24"), the compacted haunching material should be placed one pipe diameter or 24 inches (whichever is greater) to either side of the pipe.

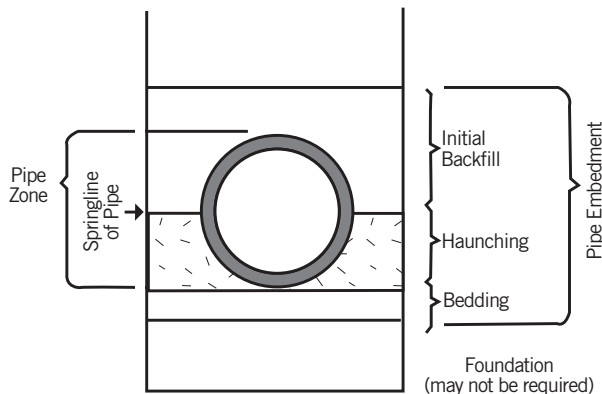

Trench Depth

As mentioned in the Design section of this manual, thermoplastic pipe will tend to deflect rather than crack under loading. The amount of deflection can be derived from the depth of burial, pipe stiffness and the amount of loading (e.g. soil, traffic) on the pipe. Although the maximum allowable deflection is 7.5% at a 4:1 safety factor, critical buckling occurs at 30%. For a given situation, the actual deflection and burial depth can be calculated.

For more detail regarding burial depth and estimating deflection under different conditions, consult your IPEX representative.

Minimum Cover

Although the project may have specifications for the required depth of burial, the following guidelines for minimum cover may prove helpful:

- Pipe should be placed 6 inches below the frost line
- For expected truck traffic (live loading - Highway H20), use a minimum cover of 12 inches (or 1 pipe diameter, whichever is greater) providing a minimum soil stiffness of $E' = 1000$.
- For expected heavy truck or train traffic, (live loading - Railway E80) use a minimum cover of 36 inches (or 1 pipe diameter, whichever is greater) providing a minimum soil stiffness of $E' = 1000$.

Maximum Cover

Pipe that is buried too deeply is also not advisable for reasons of cost and loading. For the maximum recommended cover, refer to Table 37.

Table 37 – Maximum Recommended Cover

Soil* Class	Standard Proctor Density Range (%)	E' Modulus of Soil Reaction (psi)	Maximum Height of Cover (ft)
I	-	3000	50
II	85-95	2000	50
	75-85	1000	50
	65-75	200	17
III	85-95	1000	50
	75-85	400	28
	65-75	100	12
IV	85-95	400	28
	75-85	200	17
	65-75	50	9

* as per ASTM D2321

Source: Uni-Bell Plastic Pipe Association

Trench Bottom

To properly support the pipe, the trench bottom should be continuous, relatively smooth, and free of rocks. Where hardpan or boulders are encountered, the trench bottom should be padded using a minimum of 4" of crushed rock or sand beneath the pipe. Frozen material should not be used to either support or bed the pipe.

Where the soil medium is unstable, (e.g. organic material), the trench bottom should be over excavated and brought back to grade with suitable material.

Placing the Pipe

The pipe and fittings should be placed into the trench using ropes and skids, slings on a backhoe bucket or by hand. Do not throw or drop the pipe or fittings into the trench, as damage may result. Particular care should be taken when handling pipe in cold weather, as the material is less impact resistant at reduced temperatures. Before assembly ensure that all materials are in good condition.

Snaking of Pipe

After the PVC and CPVC pipe has been solvent welded, it is advisable to snake the pipe beside the trench according to the following recommendation. **BE ESPECIALLY CAREFUL NOT TO APPLY ANY STRESS THAT WILL DISTURB THE UNDRIED JOINT.** This snaking is necessary in order to allow for any anticipated thermal contraction that will take place in the newly joined pipeline.

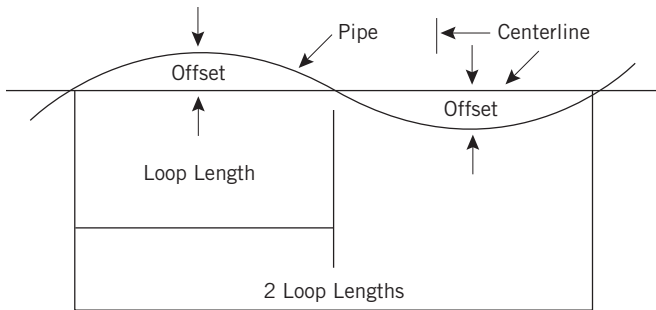

Pipe Snaking

Loop Offset in Inches for Contraction

Degrees	Maximum Temperature Variation, °F Between Time of Solvent and Final Use		
	Loop Length		
	20'	50'	100'
10	3"	7"	13"
20	4"	9"	18"
30	5"	11"	22"
40	5"	13"	26"
50	6"	14"	29"
60	6"	16"	32"
70	7"	17"	35"
80	7"	18"	37"
90	8"	19"	40"
100	8"	20"	42"

Snaking is particularly necessary on the lengths that have been solvent welded during the late afternoon of a hot summer's day, because their drying time will extend through the cool of the night when thermal contraction of the pipe could stress the joints to the point of pull out. This snaking is also especially necessary with pipe that is layed in its trench (necessitating wider trenches than recommended) and is back-filled with cool earth before the joints are thoroughly dry.

Assembly

Assemble joints in accordance with instructions found in the Installation section under Joining methods.

Resisting Thrust

For buried pressure pipe applications, thrust forces can occur at any point in a piping system where the directional or cross-sectional area of the waterway changes. These forces must be reduced by means of concrete thrust blocks or concrete encasement. This can be accomplished by pouring concrete into appropriately sized forms at each point in the line where thrust forces will develop. The concrete block must be placed between the fitting and the undisturbed native soil at the side of the trench.

For more detail regarding estimating and compensating for thrust forces, refer to the IPEX Installation Guide and engineering textbooks such as the *Uni-Bell Handbook of PVC Pipe*.

Initial Backfilling

Initial backfilling is done by covering the pipe to a depth of 6" to 12" with proper backfill material that is free from rocks, sharp objects, debris or particles larger than 3". Add layers in 6" increments ensuring that the proper compaction levels are reached for each and backfill until there is 6" to 12" of cover over the crest of the pipe.

Ensure that all joints remain exposed for visual inspection. Leave the piping to settle and normalize dimensionally then check all joints for tightness. If the piping is satisfactory then tamp the initial backfill layer.

Note 1: While tamping, ensure that the pipe alignment, both vertical and horizontal, is not disturbed.

Note 2: During hot weather it is recommended that backfilling be done in the cooler morning hours when the piping is fully contracted to avoid improper compaction due to pipe expansion.

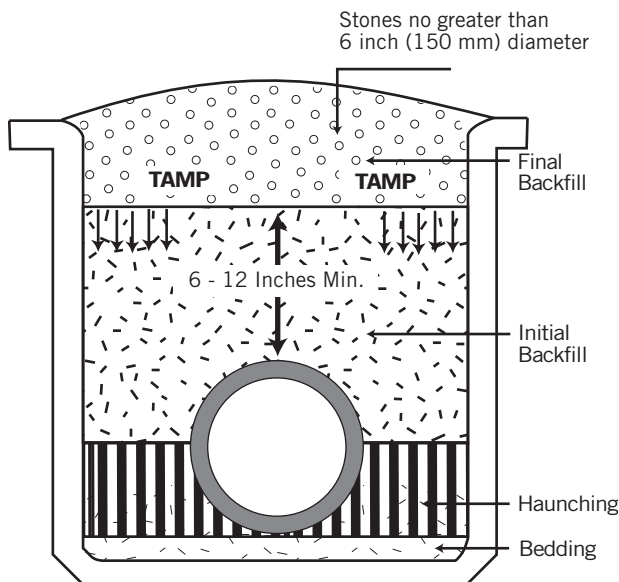

System Testing

After the system has been assembled and initially backfilled, the system must be tested for leaks. Note that the pipe must be sufficiently backfilled to prevent movement during testing.

Conduct a pressure test as per the testing procedure in this manual in the Installation section under Testing. If the test is passed, the system can be covered. If not, make the necessary repairs and test again until the system is sound.

Compacting the Final Backfill

Final backfilling is the material that is placed over the initial backfill to the top of the trench.

Compact the haunching, initial backfill and final backfill using manual equipment in accordance with the job drawings. Observe the following precautions.

- 1) When a "self-compacting" material is used, such as crushed stone, ensure that the material does not arch or bridge beneath the haunch of the pipe. Remove such voids with the tip of a spade.
- 2) When compacting the material underneath and at either side of the pipe do not allow the tool or the machine to strike the pipe.
- 3) When compaction in excess of 85% standard proctor density is required in the haunching area ensure that the compacting effort does not dislodge the pipe from the correct grade. If the compacting effort dislodges the pipe, re-lay the pipe to the correct grade.
- 4) It is not necessary to compact the initial backfill directly over the top of the pipe for the sake of the pipe's structural strength. However, it may be necessary for the sake of roadway integrity.
- 5) When laying long runs of piping in elevated air temperatures, it is advisable to begin working from a fixed point – such as the entry or exit from a building, and work away from that point, testing and backfilling in accordance with preceding paragraphs. This procedure should then allow the piping to assume soil temperature progressively as work proceeds.

TESTING

Site Pressure Testing

The purpose of an onsite pressure test is to establish that the installed section of line, and in particular all joints and fittings, will withstand the design working pressure, plus a safety margin, without loss of pressure or fluid.

Generally a test pressure of 1½ times the safe working pressure for the pipe installed is adequate. Whenever possible, it is recommended that hydrostatic testing be carried out. It is suggested that the following hydrostatic test procedure be followed after the solvent-welded joints have been allowed to cure for a minimum period of 24 hours at 73°F (23°C) (timed from the cure of last joint). For more detail, refer to the joint cure schedules in Table 22 in the Installation section.

Hydrostatic Test Procedure

- 1) Fully inspect the installed piping for evidence of mechanical abuse and/or dry suspect joints.
- 2) Split the system into convenient test sections not exceeding 1,000 ft.
- 3) Slowly fill the pipe section with water, preferably at a velocity of 1.0 fps or less. Any entrapped air should be evacuated by venting from the high points. Do not pressurize at this stage.
- 4) Leave the section for at least 1 hour to allow equilibrium temperature to be achieved.
- 5) Check the system for leaks. If clear, check for and remove any remaining air and increase pressure up to 50 psi. Do not pressurize further at this stage.
- 6) Leave the section pressurized for 10 minutes. If the pressure decays, inspect for leaks. If the pressure remains constant, slowly increase the hydrostatic pressure to 1½ times the nominal working pressure.
- 7) Leave the section pressurized for a period not exceeding 1 hour. During this time, the pressure should not change.

If there is a significant drop in static pressure or extended times are required to achieve pressure, either joint leakage has occurred or air remains in the line. Inspect for leakage and if none is apparent, reduce the pressure and check for trapped air. This must be removed before further testing.

Any joint leaks should be repaired and allowed to cure fully before re-pressurizing for a minimum of 24 hours.



WARNING



- **NEVER** use compressed air or gas in PVC/CPVC/PP/PVDF pipe and fittings.
- **NEVER** test PVC/CPVC/PP/PVDF pipe and fittings with compressed air or gas, or air-over-water boosters.
- **ONLY** use PVC/CPVC/PP/PVDF pipe for water and approved chemicals.

Use of compressed air or gas in PVC/CPVC/PP/PVDF pipe and fittings can result in explosive failures and cause severe injury or death.

REPAIRS

Repairs Below Ground

Defective joints or damaged sections in pipes below ground may be repaired quickly and easily using gasketed repair couplings as follows:

- 1) Cut out the damaged section (minimum 18 inches long).
- 2) File the ends square and chamfer by 45° to assist entry of pipe into the fitting.
- 3) Measure gap and cut new section of pipe to the measured length minus ¼ inches.
- 4) Prepare ends of this new pipe to a 45° chamfer.
- 5) Clean the existing and new pipe. Do not abrade.
- 6) Push o-ring repair couplings onto the exposed ends of the existing pipe.
- 7) Insert new pipe into the gap.
- 8) Draw repair couplings on the new pipe so that the joint between pipes is at the center of the coupling.

Note 1: Do not use solvent cement, or primer MEK cleaner with gasketed repair couplings.

Note 2: The pipe route should be examined to ensure that axial movement of the pipes will not take place upon pressurizing the system. If this seems likely, suitable anchors must be provided to resist the thrusts that occur under pressure.

Joint Repairs

Taking into consideration the cost of materials, time involved and labor costs, in most cases the installer is better off cutting out the defective joint, replacing it with new materials and taking greater care in the joining process.

However, fillet welding of a minor leak in a joint is possible.



Repairing Thermoplastic Pipe Joints

Scope

The most common method for repairing faulty and leaking joints is hot gas welding at the fillet formed by the fitting socket entrance and the pipe. Fillet welding of thermoplastics is quite similar to the acetylene welding or brazing process used with metals. The fundamental differences are that the plastic rod must always be the same basic material as the pieces to be joined and heated gas, rather than burning gas, is used to melt the rod and adjacent surfaces.

Welding with plastics involves only surface melting because plastics, unlike metals, must never be “puddled”. Therefore the resulting weld is not as strong as the parent pipe and fitting material. This being the case, fillet welding as a repair technique is recommended for minor leaks only. It is not recommended as a primary joining technique for pressure rated systems.

Welding Tools and Materials

- Plastic welding gun with pressure regulator, gauge and hose
- Filler rod
- Emery cloth
- Cotton rags
- Cutting pliers
- Hand grinder (optional)
- Compressed air supply or bottled nitrogen (see Caution)
- Source of compressed air

Weld Area Preparation

Wipe all dirt, oil and moisture from the joint area. A very mild solvent may be necessary to remove oil.

CAUTION: Make sure that all liquid has been removed from the portion of the piping system where the weld is to be made.

Welding Faulty Joints

1. Remove residual solvent cement from the weld area using emery cloth. When welding threaded joints, a file can be used to remove threads in the weld area.



2. Wipe the weld area clean of dust, dirt and moisture.



3. Determine the amount of the correct filler rod (see Table) necessary to make one complete pass around the joint by wrapping the rod around the pipe to be welded.



Increase this length enough to allow for handling the rod at the end of pass.

4. Make about a 60° angular cut on the lead end of the filler rod. This will make it easier to initiate melting and will insure fusion of the rod and base material at the beginning of the weld.



5. Welding temperatures vary for different thermoplastic materials (500°F – 550°F (260°C - 288°C) for PVC and CPVC). Welding temperatures can be adjusted for the various thermoplastic materials as well as any desired welding rate by adjusting the pressure regulator (which controls the gas flow rate) between 3 and 8 psi.

CAUTION: For welding guns which require compressed gas, nitrogen is preferred when the compressed plant air system does not contain adequate drying and filtrations.

Because of its economy, compressed air is normally the gas of choice for most plastic welding. A welding gun which generates its own air supply is frequently desirable for field-made pipe joints where ultimate weld strength is not required. For welding guns which require compressed gas, nitrogen is preferable when the compressed plant air system does not contain adequate drying and filtration. (Presence of moisture in the gas stream causes premature failure in the heater element of the welding gun. Impurities in the gas stream, particularly those in oil, may oxidize the plastic polymer, resulting in loss of strength. Polypropylene is known to be affected in this manner.)

6. With air or inert gas flowing through the welding gun, insert the electrical plug for the heating element into an appropriate electrical socket to facilitate heating of the gas and wait approximately 7 minutes for the welding gas to reach the proper temperature.

CAUTION: The metal barrel of the welding gun houses the heating element so it can attain extremely high temperatures. Avoid contact with the barrel and do not allow it to contact any combustible materials.

Filler rod size and number of weld passes required to make a good plastic weld are dependent upon the size of the pipe to be welded as presented below:

Pipe Sizes (in)	Rod Sizes (in)	Number of Passes
1/2 - 3/4	3/32	3
1 - 2	1/8	3
2-1/2 - 4	3/16	3
6 - 8	3/16	5
10 - 12	3/16	5

7. Place the leading end of the filler rod through the speed tip opening and into the fillet formed by the junction of the pipe and fitting socket entrance. Holding the weld tip at a 45° angle to the fitting, slowly move the weld tip across the area to be welded while applying a slight pressure by pushing the rod from the inlet side. The weld tip should be approximately 1/4" to 1/2" away from the material.



8. End each pass by mating the rod end to the starting point. Do not overlap on top or to the side of the start point. Each weld end should match perfectly with the starting point.



9. When welding large diameter pipe, more than three weld passes may be required. The first bead should be deposited at the bottom of the fillet and subsequent beads should be deposited on each side of the first bead. When making multiple pass welds, the starting points for each bead should be staggered and ample time must be allowed for each weld to cool before proceeding with additional welds.

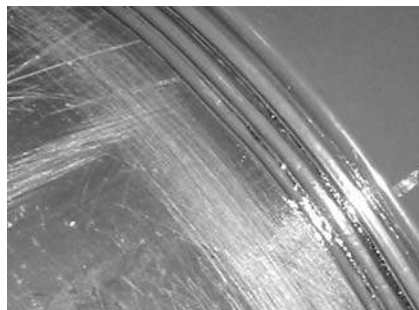

10. Properly applied plastic welds can be recognized by the presence of small flow lines or waves on both sides of the deposited bead. This indicates that sufficient heat was applied to the surfaces of the rod and base materials to effect adequate melting and that sufficient pressure was applied to the rod to force the rod melt to fuse with base material melt. If insufficient heat is used when welding PVC or CPVC the filler rod will appear in its original form and can easily be pulled away from the base material. Excessive heat will result in a brown or black discoloration of the weld.

Welding Principles

The procedures for making good thermoplastic welds can be summarized into four basic essentials:

- **Correct Heating**
Excessive heating will char or overmelt. Insufficient heating will result in incomplete melting.
- **Correct Pressure**
Excessive pressure can result in stress cracking when the weld cools. Insufficient pressure will result in incomplete fusion of the rod material with the base material.
- **Correct Angle**
Incorrect rod angle during welding will stretch the rod and the rod material with the base material.
- **Correct Speed**
Excessive welding speed will stretch the weld bead and the finished weld will crack upon cooling.

INSTALLATION CONSIDERATIONS

Entrapped Air

Air entrapment in pressure pipelines is a much studied and discussed topic. Most designers are concerned about it but may not understand the full implications of the problem or the processes used to reduce the dangers associated with entrapped air. The problem with entrapped air is that it is a complex issue. The behavior of air in a piping system is not easy to analyze, but the effects can be devastating.

Sources of Air in Pipelines

There are many potential sources for air in pipelines and the sources are usually multiple in any given system. The most likely source occurs during filling, either initially or when refilled after drainage. In some systems, air re-enters each time the pumps are shut off as the pipelines drain through low lying sprinklers or open valves.

Air is often introduced at the point where water enters the system. This is an especially common problem with gravity fed pipelines, but may occur with pumped systems as well. Even water pumped from deep wells may be subject to air entering from cascading water in the well.

A less obvious source of air comes from the release of dissolved air in the water, due to changes in temperature and/or pressure. The quantities may be small in this case, but accumulations over time can create problems.

It is also common for air to enter through mechanical air release valves or vacuum breakers when the pressure drops below atmospheric pressure. This can occur during pump shutdown or during negative surges.

Why is Entrapped Air a Problem?

Air in a piping system tends to accumulate at high points during low flow or static conditions. As the flowrate increases, the air can be forced along the pipeline by the moving water and may become lodged at the more extreme high points where it reduces the area available for flow. Thus, these pockets of air cause flow restrictions that reduce the efficiency and performance of the system.

As an air pocket grows, the velocity past that point increases until eventually the air is swept on toward an outlet. While line restrictions are problems, a more serious situation can occur when air is rapidly vented from the system under pressure. Water is about five times more dense than air at 100 psi, so when a pocket of compressed air reaches an outlet, such as a sprinkler head or air release valve, it escapes very rapidly. As it escapes, water rushes in to replace the void.

When water reaches the opening, the velocity suddenly decreases, since air escapes about five times faster than water at 100 psi. The result is similar to instantaneous valve closure, except that the velocity change can far exceed the normal flow velocity in the pipeline. During tests at Colorado State University, pressure surges up to 15 times the operating pressure have been recorded when entrapped air was rapidly vented under pressure. Such pressure surges can easily exceed the strength of the system components and even at lower magnitudes, repeated surges will weaken the system over time.

Dealing with Entrapped Air

Obviously, the best way to reduce problems caused by entrapped air would be to prevent it from entering the system. Precautions should be taken to eliminate air entrance. When systems are filled, either initially or after draining for winterization or repair, they should be filled slowly, at a velocity of 1.0 fps or less, and the air should be vented from the high points before the system is pressurized. Even with these precautions, some air can remain in the system.

To deal with this remaining air or newly admitted air generated by the process itself, one or more continuous-acting air relief valves should be incorporated in the line. One solution would be to use manual vent valves such as ball valves. This solution is not ideal as strategically positioned manual vent valves can deal with entrapped air at startup, but will not deal automatically or effectively with recurring air entrapment problems. In addition, manually operated vents will inevitably lead to spills potentially resulting in site contamination or operator injury (depending on the carried media).

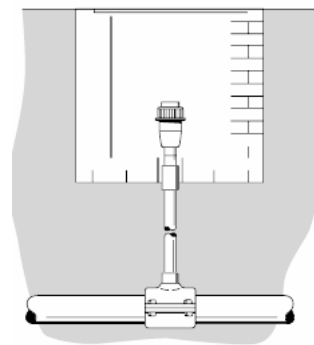

To ensure an effective means of dealing with entrapped air, continuous acting valves should be the preferred choice. Continuous-acting valves contain a float mechanism which allows the air to vent through a small orifice, even when the line is pressurized.

Also available on the market are combination air-release/vacuum braking valves. These products have dual functions. For example, when a tank is being filled, the entrapped air is allowed to escape and the liquid is allowed to rush in unopposed by air pockets. When the process is reversed, during the draining of a tank, the valve shutting mechanism opens the valve allowing air to rush in and replace the volume previously held by the liquid, thus preventing the formation of a potentially damaging vacuum.

IPEX offers the VA Air Release valve, a piston style air-release/vacuum breaker valve in $\frac{3}{4}$ ", $1\frac{1}{4}$ " and 2" sizes. It is important to note that the open and close functions of this 'smart' valve are controlled by media and not pressure as in other air-release valves. This feature provides several advantages. No minimum pressure or vacuum is required to either open or close the valve, thus guaranteeing responsiveness in any and all conditions while eliminating the potential for spillage.



Ultraviolet Light

UV sterilizers for killing bacteria in de-ionized water are common. Over time, the intense light generated by these sterilizers will stress crack PVC and CPVC pipe directly connected to the sterilizer. To minimize this problem, a transition trap between the sterilizer and the vinyl pipe is recommended.

Ozone

Ozone (O₃) is a form of oxygen. In its pure form, it is an unstable blue gas with a pungent odor. Ozone is used as a bactericide in de-ionized water systems in low concentrations of 0.04 to 5 ppm. It presents no problem to thermoplastic piping in aqueous form.

Note: Ozone in gaseous form should not be used with PVC or CPVC pipe.

Commercial mixtures are ordinarily 2% ozone and are produced by the electronic irradiation of air. It is usually manufactured on the spot, as it is too costly to ship.

Butyl rubber and ethylene propylene rubber (EPDM) have good resistance to ozone, as does fluorine rubber (Viton) and chlorosulfonated polyethylene (Hypalon). NEOPRENE AND BUNA-N OR NITRILE ARE SEVERELY ATTACKED.

Chemical Resistance

Pipe, Valves and Fittings

Thermoplastics have outstanding resistance to a wide range of chemical reagents. Such resistance is a function of both temperature and concentration, and there are many reagents which can be handled for limited temperature ranges and concentrations. In borderline cases, there may be limited attack, generally resulting in some swelling due to absorption. There are also many cases where some attack will occur under specific conditions. For such applications, the use of plastic is justified on economic grounds when considered against alternative materials. Chemical resistance is often affected (and frequently reduced) when handling a number of chemicals or compounds containing impurities. When specific applications are being considered, it is often worthwhile to conduct tests using the actual fluid that will be used in service.

In general, PVC is suitable with most strong acids, alkalis, aqueous solutions, aliphatic hydrocarbons, fluorides, photographic and plating solutions, brine and mineral oils. It should not be used with aldehydes and ketones, ethers, esters or aromatic and chlorinated hydrocarbons.

CPVC has a chemical resistance similar to or marginally better than PVC.

Gaskets and Seals

EPDM has excellent resistance to oxidation products but will show a certain swelling when in contact with mineral and petroleum oils, diester base lubricants and organic solvents.

Nitrile is a general purpose oil resistant polymer known as nitrile rubber. Nitrile is a copolymer of butadiene and acrylonitrile. Nitrile has good solvent, oil, water and hydraulic fluid resistance. It displays good compression set, abrasion resistance and tensile strength. Nitrile should not be used with highly polar solvents such as acetone and methyl ethyl ketone, nor should it be used with chlorinated hydrocarbons, ozone or nitro hydrocarbons. Temperature ranges from -65°F (-54°C) to 275°F (135°C).

FPM (Viton) has excellent resistance to chemical agents. It is virtually inert to oil and most solvents and it also exhibits good chemical capability with many aromatic and aliphatic hydrocarbons.

Please refer to the IPEX Chemical Resistance Guide for specific applications.



Heat Tracing

Although thermoplastic pipes are poor conductors of heat, heat tracing may be necessary to maintain a constant elevated temperature for a viscous liquid, to prevent liquid from freezing, or to prevent a liquid such as 50% sodium hydroxide, from crystallizing in a pipeline. Electric heat tracing with self-regulating temperature-sensing tape will maintain a 90°F (32°C) temperature to prevent sodium hydroxide from freezing. The tape should be S-pattern-wrapped on the pipe, allowing for pipe repairs and avoiding deflection caused by heating one side of the pipe.

Heat tracing should be applied directly on the pipe within the insulation, and must not exceed the temperature, pressure or chemical resistance design of the system.

In some cases, it may be necessary to install 2 or more cables with reduced output to ensure a more even heat distribution and penetration without exceeding the maximum operating temperature of the pipe.

Tapping for Instrumentation Connections

For applications that require tapping PVC systems for instrumentation connections, the following guidelines should be followed:

- a. Hole drilling and tapping should be performed while the system is non-pressurized.
- b. IPEX recommends using schedule 80 pipe and fittings to maximize wall thickness.
- c. Tapping should be done by drilling through the area where the pipe and fitting socket overlap. This area will have maximum wall thickness to allow for sufficient threads.
- d. Teflon® (PTFE) tape or an IPEX approved thread sealant should be used for sealing threads.
- e. Taps should be made at least 3 feet from the end of the pipe (unless tapping through a fitting socket into pipe)
- f. Teflon® (PTFE) tape or an IPEX approved thread sealant should be used for sealing threads.
- g. Where saddle connections are required, hole sizing should be no larger than one half of the nominal pipe size:
 - i. When assembling Saddles to PVC pipe, IPEX recommends Industrial Polychemical Service (IPS) #719 cement, or equivalent.
 - ii. Although good connections may be accomplished without Saddle Straps, IPEX recommends the use of a clamp or strap device during the assembly step to ensure good compression between the pipe and fitting surfaces as the solvent cures.

Listed below are the pipe sizes and maximum connection sizes that may be used:

Pipe Size	Size of Connection
1/4" to 2"	Use tees, reducer bushings, and threaded fittings
2-1/2" to 4"	Max tapping 1/2" NPT
6" and greater	Max tapping 1" NPT

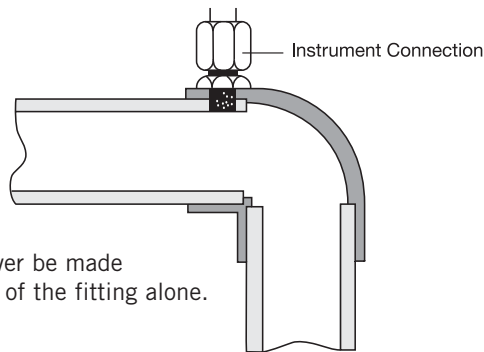

A tap should never be made through the wall of the fitting alone.

Direct Tapping

For applications that require direct tapping of existing PVC lines, the following guidelines should be followed:

- a. Hole drilling and tapping should be performed while the line is non-pressurized.
- b. Direct tapping should only be performed on Schedule 80 pipe:
 - i. IPEX does not recommend direct tapping 1/4" to 2" pipe sizes.
 - ii. Hole sizes should be no greater than 1/2" NPT for 2-1/2" to 4" pipe sizes.
 - iii. Hole sizes should be no greater than 1" NPT for 6" and greater pipe sizes.
- c. Taps should be made at least 3 feet from the end of the pipe (unless tapping through a fitting socket into pipe)
- d. Teflon® (PTFE) tape or an IPEX approved thread sealant should be used for sealing threads.
- e. Where saddle connections are required, hole sizing should be no larger than one half of the nominal pipe size:
 - i. When assembling Saddles to PVC pipe, IPEX recommends Industrial Polychemical Service (IPS) #719 cement, or equivalent.
 - ii. Although good connections may be accomplished without Saddle Straps, IPEX recommends the use of a clamp or strap device during the assembly step to ensure good compression between the pipe and fitting surfaces as the solvent cures.

For further details, please contact your IPEX representative.

These recommendations should always be referenced against local plumbing and mechanical codes as well as the local authority having jurisdiction.

Static Electricity

The non-conductive properties of thermoplastic piping materials, such as PVC and CPVC, are generally considered advantageous, particularly in electrical or electronic applications. In certain other applications these properties are considered a disadvantage, as the flowing media can allow electrostatic charges to be generated and accumulated. The potential exists for charges to accumulate to the point of becoming sources of ignition that can create sparks.

Static electricity (electrostatic charge) is generated by the separation and insulation of like bodies. In general this occurs during the transport of dry bulk solids, powders and slurries. In the case of powders, electrical charge can accumulate on several items in the piping process, including but not limited to the material itself, containers the material is poured into, metal equipment involved in or proximate to the pouring operation, as well as on the operators themselves.

In order to prevent charge from accumulating, all equipment and personnel should be grounded and measures should be taken to directly dissipate any charges by increasing the conductivity of the pipeline. This can be done by several methods, including:

- Coating the pipe surfaces with a solvent-free conductive metallic powder coating then grounding the pipe.
- Wrapping conductive wire around the pipe for the entire length of pipe and then running it to ground.
- Increasing the relative atmospheric humidity. A thin film of moisture on the pipe will improve conductivity. Although this is a somewhat temporary measure, the film can be made more intact by treating the pipeline surface with a **compatible** hygroscopic (water loving) soap.

SECTION FOUR: SPECIALTY PIPING PRODUCTS

PVC Well Casing – ASTM F 480



IPEX bell end PVC well casing provides corrosion-resistant, maintenance-free protection for well drop-pipe and submersible pumps. Its light weight facilitates installation with conventional tools and piping techniques. It is manufactured to ASTM standards and is available throughout North America from IPEX's fully stocked service centers.

Features

- Meets ASTM D 1784, D 1785, D 2665*, and F 480 specifications.
- Third-party certified by NSF.
- Solvent weld joints are strong and water tight.
- Installation can be accomplished with lighter setting equipment than is required for metallic piping.
- Electrically non-conductive which reduces job site work hazards.
- Non-toxic and non-leaching with excellent chemical resistance.
- Available in bell end 2" - 16" or plain end for threading 2" - 12".

* schedule 40 pipe only

Table 38 – Dimensions for Xirtec140 PVC Well Casing Pipe – ASTM F480

Pipe Size (in.)	Outside Diameter (in.)		Minimum Wall Thickness (in.)			Bell Length (in.)
	Average	Tolerance on Average	SDR21	Sch 40	Sch 80	
2	2.375	±0.006	0.113	0.154	0.218	4.000
2½	2.875	±0.007	0.137	0.203	0.276	5.000
3	3.500	±0.008	0.167	0.216	0.300	5.500
4	4.500	±0.009	0.214	0.237	0.337	6.500
5	5.563	±0.010	0.265	0.258	0.375	6.000
6	6.625	±0.011	0.316	0.280	0.432	8.000
8	8.625	±0.015	0.410	0.322	0.500	7.000
10	10.750	±0.015	0.511	0.365	0.593	7.500
12	12.750	±0.015	0.606	0.406	0.687	8.500
14	14.000	±0.020	0.667	0.437	0.750	9.000
16	16.000	±0.020	0.762	0.500	0.843	10.000

* only available in select markets. Contact you local IPEX office for further information

PVC & CPVC Exhaust System Ducting

IPEX PVC & CPVC exhaust system ducting provides effective solutions for industrial ventilation systems, protecting workers and the environment from contaminated air.



PVC Features

- Extruded seamless PVC duct in all standard diameters 6" through 24"
- PVC cell class 12454 as per ASTM D1784
- For use in industrial and institutional fume handling systems requiring high resistance to corrosive vapors
- Ideal for plating, metal finishing and laboratory installations
- Low installed cost as compared to noncorrosive metallics
- Light weight allows longer runs and speeds installation with simple tools and piping techniques
- Low maintenance requirements over extended service periods
- Low flame spread rating of 10 as per CAN/ULC S102.2

CPVC Features

- Extruded seamless CPVC duct in all standard diameters 6" through 16"
- CPVC withstands exhaust temperatures up to 200°F
- CPVC cell class 23447 as per ASTM 1784
- CPVC is inert to most mineral acids, bases, salts, and aliphatic hydrocarbons, and compares favorably to other non-metals in corrosive chemical environments.
- Ideal for chemical processing, semiconductor fabrication, metal plating & finishing, pulp & paper, waste water treatment plants, and laboratory installations
- Low installed cost as compared to non-corrosive exotic metal systems and PVDF
- Light weight allows for ease of handling and installation and reduces transportation and labor costs
- Low maintenance requirements over extended service periods
- Low flame spread rating of 10 and smoke development classification of 25 as per CAN/ULC S102.2
- Corzan® CPVC compound meets and is listed FM 4910 "Clean Room Materials Flammability Test Protocol" approval standard

Table 39 – PVC & CPVC Duct Dimensions

Duct Size (diameter in inches)	Average O.D. (in.)	Average I.D. (in.)	Average Wall Thickness (in.)	Weight (lbs/ft) PVC	Weight (lbs/ft) CPVC
6	6.625	6.251	0.187	2.319	2.519
8	8.625	8.251	0.187	3.040	3.301
10	10.750	10.376	0.187	3.805	4.133
12	12.750	12.376	0.187	4.528	4.916
14	14.000	13.626	0.187	4.978	5.405
16	16.000	15.626	0.187	5.697	6.188
18	18.000	17.626	0.187	6.420	–
20	20.000	19.500	0.250	9.515	–
24	24.000	23.500	0.250	11.442	–

* CPVC Duct only available up to 16" diameter.



CAUTION

1. A significant charge of static electricity can be generated by the flow of air through plastic duct, particularly under very dry conditions. If combustible particles or gases are being transported, then various electrical ground techniques must be applied. An expert in this area should be consulted during the design phase.
2. The need for closed-head sprinkler systems may be necessary if combustible residues or oxidizable materials are likely to accumulate in the duct work over a period of time.
3. Chemical resistance and operating temperatures must be evaluated in the same manner as for standard PVC & CPVC pipe. When in doubt, consult your local IPEX customer service center.

SECTION FIVE: SPECIFICATIONS

STANDARDS

Standards exist to ensure that thermoplastic piping systems meet the required level of performance for a particular application. IPEX engineers and technical staff actively participate in thermoplastic standards development throughout North America. These activities result in new standards and improvements to existing standards for thermoplastic piping.

Standards Organizations

IPEX products comply with standards developed by several standards organizations. Additional information on standards and compliance can be obtained by contacting the following organizations.

**CSA International, www.csa.ca
5060 Spectrum Way, Mississauga, Ontario Canada L4W 5N6**

**ASTM International, www.astm.org
100 Barr Harbor Drive, West Conshohocken, Pennsylvania USA 19428-2959**

**Underwriters Laboratories of Canada, www.ulc.ca
7 Underwriters Rd, Toronto, Ontario Canada M1R 3B4**

**NSF International, www.nsf.org
P.O. Box 130140, 789 N. Dixboro Rd, Ann Arbor, Michigan USA 48113-0140**

Applicable Standards

The following is a list of applicable standards for IPEX PVC and CPVC piping systems. This list is up-to-date at the time of printing.

ASTM

Standard Specifications for Terminology Relating to Plastics

D883	Terminology Relating to Plastics
D1600	Terminology for Abbreviated Terms Relating to Plastics
F412	Terminology Relating to Plastic Piping Systems
D2749	Standard Symbols for Dimensions of Plastic Pipe Fittings

Standard Specifications for Plastic Materials

D1784	Rigid Poly (Vinyl Chloride) (PVC) Compounds and Chlorinated Poly (Vinyl Chloride) (CPVC) Compounds
D2564	Solvent Cements for Poly (Vinyl Chloride) (PVC) Plastic Piping Systems
D2672	Joints for IPS PVC Pipe Using Solvent Cement
D3138	Solvent Cements for Transition Joints Between Acrylonitrile-Butadiene-Styrene (ABS) and Poly (Vinyl Chloride) (PVC) Non-Pressure Piping Components
D3915	Rigid Poly (Vinyl Chloride) (PVC) and Chlorinated Poly (Vinyl Chloride) (CPVC) Compounds for Plastic Pipe and Fittings used in Pressure Applications
D4396	Rigid Poly (Vinyl Chloride) (PVC) and Chlorinated Poly (Vinyl Chloride) (CPVC) Compounds for Plastic Pipe and Fittings Used in Nonpressure Applications
F493	Solvent Cements for Chlorinated Poly (Vinyl Chloride) (CPVC) Plastic Pipe and Fittings
F656	Primers for Use in Solvent Cement Joints of Poly (Vinyl Chloride) (PVC) Plastic Pipe and Fittings

Standard Specifications for Plastic Pipe

D1785	Poly (Vinyl Chloride) (PVC) Plastic Pipe, Schedules 40, 80, and 120
D2241	Poly (Vinyl Chloride) (PVC) Pressure-Rated Pipe (SDR Series)
D2665	Poly (Vinyl Chloride) (PVC) Plastic Drain, Waste, and Vent Pipe and Fittings
D3139	Joints for Plastic Pressure Pipes Using Flexible Elastomeric Seals
D3212	Joints for Drain and Sewer Plastic Pipes Using Flexible Elastomeric Seals
F441/ F441M	Chlorinated Poly (Vinyl Chloride) (CPVC) Plastic Pipe, Schedules 40 and 80
442/ F442M	Chlorinated Poly (Vinyl Chloride) (CPVC) Plastic Pipe (SDR-PR)
F477	Elastomeric Seals (Gaskets) for Joining Plastic Pipe
F480	Thermoplastic Well Casing Pipe and Couplings Made in Standard Dimension Ratios (SDR), Sch 40 & Sch 80
F913	Thermoplastic Elastomeric Seals (Gaskets) for Joining Plastic Pipe

Standard Specifications for Plastic Pipe Fittings

D2464	Threaded Poly (Vinyl Chloride) (PVC) Plastic Pipe Fittings Schedule 80
D2466	Poly (Vinyl Chloride) (PVC) Plastic Pipe Fittings, Schedule 40
D2467	Poly (Vinyl Chloride) (PVC) Plastic Pipe Fittings, Schedule 80
D2665	Poly (Vinyl Chloride) (PVC) Plastic Drain, Waste and Vent Pipe and Fittings
F437	Threaded Chlorinated Poly (Vinyl Chloride) (CPVC) Plastic Pipe Fittings, Schedule 80
F438	Socket-Type Chlorinated Poly (Vinyl Chloride) (CPVC) Plastic Pipe Fittings, Schedule 40
F439	Socket-Type Chlorinated Poly (Vinyl Chloride) (CPVC) Plastic Pipe Fittings, Schedule 80
F1803	Poly (Vinyl Chloride) (PVC) Closed Profile Gravity Pipe and Fittings Based on Controlled Inside Diameter
F1866	Poly (Vinyl Chloride) (PVC) Plastic Schedule 40 Drainage and DWV Fabricated Fittings
F1970	Special Engineered Fittings, Appurtenances or Valves for use in Poly (Vinyl Chloride) (PVC) or Chlorinated Poly (Vinyl Chloride) (CPVC) systems

Standard Specifications for Method of Test

D256	Test Method for Determining the IZOD Pendulum Impact Resistance of Notched Specimens of Plastics
D570	Test Method for Water Absorption of Plastics
D635	Test Method for Rate of Burning and/or Extent and Time of Burning of Plastics in a Horizontal Position
D638	Test Method for Tensile Properties of Plastics
D648	Test Method for Deflection Temperature of Plastics Under Flexural Load in the Edgewise Position
D790	Test Methods for Flexural Properties of Unreinforced and Reinforced Plastics and Electrical Insulating Materials
D1598	Test Method for Time-to-Failure of Plastic Pipe Under Constant Internal Pressure
D1599	Test Method for Short-Time Hydraulic Failure Pressure of Plastic Pipe, Tubing and Fittings
D2122	Test Method for Determining Dimensions of Thermoplastic Pipe and Fittings
D2152	Test Method for Adequacy of Fusion of Extruded Poly (Vinyl Chloride) (PVC) Pipe and Molded Fittings by Acetone Immersion
D2412	Test Method for Determination of External Loading Characteristics of Plastic Pipe by Parallel-Plate Loading
D2444	Test Method for Determination of Impact Resistance of Thermoplastic Pipe and Fittings by Means of a Tup (Falling Weight)
D2837	Test Method for Obtaining Hydrostatic Design Basis for Thermoplastic Pipe Materials
D3212	Joints for Drain and Sewer Plastic Pipes Using Flexible Elastomeric Seals
F610/ F610M	Evaluating the Quality of Molded Poly (Vinyl Chloride) (PVC) Plastic Fittings by the Heat Reversion Technique

Standard Specifications for Practices

D543	Practices for Evaluating the Resistance of Plastics to Chemical Reagents
D618	Practice for Conditioning Plastics for Testing
D2321	Practice for Underground Installation of Thermoplastic Pipe for Sewers and Other Gravity-Flow Applications
D2855	Practice for Making Solvent-Cemented Joints with Poly (Vinyl Chloride) (PVC) Pipe and Fittings
D4703	Practice for Compression Molding Thermoplastic Materials into Test Specimens, Plaques or Sheets
F402	Practice for Safe Handling of Solvent Cements, Primers and Cleaners Used for Joining Thermoplastic Pipe and Fittings
F1057	Practice for Estimating the Quality of Extruded Poly (Vinyl Chloride) (PVC) Pipe by the Heat Reversion Technique

NSF International

- ANSI/NSF 14 Plastic Piping System Components and Related Materials
- ANSI/NSF 61 Drinking Water System Components – Health Effects

CSA International

- B137.0 Definitions, General Requirements and Methods of Testing for Thermoplastic Pressure Piping
- B137.2 PVC Injection-Molded Gasketed Fittings for Pressure Applications
- B137.3 Rigid Polyvinyl Chloride (PVC) Pipe for Pressure Applications
- B137.6 CPVC Pipe, Tubing and Fittings for Hot- and Cold-Water Distribution Systems
- B181.2 PVC Drain, Waste and Vent Pipe and Pipe Fittings

NFPA/UL/ULC/ASTM – Burning

- ASTM E84 Test Method for Surface Burning Characteristics of Building Materials
- CAN/ULC S102.2 Surface Burning Characteristics of Flooring, Floor Covering and Miscellaneous Materials
- NFPA255 Standard Method of Test of Surface Burning Characteristics of Building Materials
- UL 94 Test for Flammability of Plastic Materials for Ports in Devices and Appliances
- UL 723 Test for Surface Burning Characteristics of Building Materials

PRODUCT SPECIFICATIONS

Xirtec Schedule 40 and 80 PVC Industrial Pipe and Fittings

Scope

This specification sheet covers the manufacturers' requirements for PVC Schedule 40 and Schedule 80 IPS pressure pipe. The pipe and fittings meet or exceed all applicable ASTM, NSF and CSA standards and are suitable for potable water.

Xirtec140 PVC Materials

Rigid PVC (polyvinyl chloride) used in the extrusion of Schedule 40 & 80 pipe and fittings complies with the material requirements of ASTM D1784 (formerly Type 1, Grade 1) and has a cell classification of 12454. Raw material used in the extrusion shall contain the standard specified amounts of color pigment, stabilizers and other additives. The compounds used are listed to the requirements of NSF 61 for use in potable water service.

Dimensions

Physical dimensions and properties of Xirtec140 PVC Schedule 40 and 80 pipe and fittings shall meet the requirements of ASTM D1785 and/or be certified to CSA B137.3. Socket dimensions of belled end pipe shall meet the requirements of ASTM D2672 or F480.

Marking

Xirtec140 PVC Schedule 40 and 80 pipe is marked as prescribed in ASTM D1785, NSF 14 and/or CSA B137.0/137.3. The marking includes the following: IPEX; Xirtec140; IPS PVC and the Schedule and Pressure Rating at 73°F (23°C); ASTM D1785; CSA B137.3; NSF 14; and NSF 61 Potable.

Sample Specification

All Xirtec140 PVC Schedule 40 and 80 pipe shall conform to ASTM D1785, NSF 14, and/or CSA B137.0/B137.3. Xirtec140 Schedule 40 fittings shall conform to ASTM D2466. Xirtec140 Schedule 80 socket fittings shall conform to ASTM D2467 and Schedule 80 threaded fittings shall conform to ASTM D2464. All fittings must be third party certified to NSF 14.

All Xirtec Schedule 80 fabricated fittings shall be reinforced with fiberglass reinforced plastic (FRP). All PVC fittings shall be molded or fabricated from Xirtec140 PVC compound compatible with the pipe material.

Only Xirtec140 Schedule 80 pipe shall be threaded and the pressure rating shall be reduced by 50%. Belled end pipe socket dimensions shall conform to ASTM D2672 or F480.

All pipe, fittings and valves shall be compatible Xirtec140 and produced by one manufacturer; as supplied by IPEX.

Corzan Schedule 40 and 80 CPVC Industrial Pipe and Schedule 80 CPVC Fittings

Scope

This specification sheet covers the manufacturers' requirements for CPVC Schedule 40 and Schedule 80 IPS pressure pipe and Schedule 80 IPS pressure fittings. The pipe and fittings meet or exceed all applicable ASTM and NSF standards and are suitable for potable water.

CPVC Materials

Rigid CPVC (chlorinated polyvinyl chloride) used in the manufacturing of Schedule 40 and 80 pipe complies with the material requirements of ASTM D1784 and has a cell classification of 24448 (23447 from 10" to 16"). Rigid CPVC used in the manufacture of Schedule 80 Fittings shall meet the material requirements of ASTM D1784 and Have a cell classification of 23447 and carry a pressure rating listed by PPI (Plastic Pipe Institute).

Raw material used in the manufacturing shall contain the standard specified amounts of color pigment, stabilizers, and other additives. The compounds used are listed to the requirements of NSF 61 for use in potable water service. The compound must be Corzan grade. The compound must also exhibit a flame spread rating of 10 and a smoke development classification of 25 when tested in accordance with CAN/ULC S102.2.

Dimensions

Physical dimensions and properties of CPVC Schedule 40 and Schedule 80 pipe shall meet or exceed the requirements of ASTM F441.

Physical dimensions and properties of CPVC Schedule 80 fittings – socket type – shall meet the requirements of ASTM F439. Physical dimensions and properties of CPVC Schedule 80 Fittings – threaded type – shall meet the requirements of ASTM F437. Threaded fittings have a taper pipe thread in accordance with ANSI/ASME B1.20.1

Marking

CPVC Schedule 40 and 80 pipe is marked as prescribed in ASTM F441 and NSF 14. The marking includes the following: IPEX; CORZAN 24448 (23447); IPS CPVC and the schedule and pressure rating at 73°F (23°C); ASTM F441; NSF 14; and NSF 61 Potable.

*** 1-1/4" to 2-1/2" Schedule 80 CPVC pipe is third party certified by NSF to CSA B137.6 ***

CPVC Schedule 80 fittings are marked as prescribed in ASTM F437 and F439. The marking includes the following: IPEX; CPVC and the size of the fitting; ASTM F437 or ASTM F439; NSF 14; and NSF 61 potable.

Sample Specification

All CPVC Schedule 80 pipe shall conform to ASTM F441/F441M and be third party certified to NSF 14. All CPVC Schedule 40 and Schedule 80 pipe from 1/2" to 8" shall be made with a CPVC compound having a minimum cell classification of 24448. CPVC Schedule 80 socket fittings shall conform to ASTM F439 and Schedule 80 threaded fittings shall conform to ASTM F437. All fittings must be third party certified to NSF 14. The CPVC fitting compound shall be pressure rated in accordance with ASTM D2387 and have a hydrostatic design basis of 4000 psi at 72F and 1000 psi at 180F as listed in PPI publication TR-4.

All CPVC Schedule 40 and 80 pipe and fittings shall be made from a 4000 psi HDB PPI rated compound. All CPVC Schedule 80 fabricated fittings shall be reinforced with fiberglass reinforced plastic (FRP). All CPVC fittings shall be molded or fabricated from CPVC compound that is compatible with the pipe material.

Only IPEX CPVC Schedule 80 pipe shall be threaded and the pressure rating shall be reduced by 50%. All pipe, fittings and valves shall be compatible, produced using Corzan* compound and be produced by one manufacturer as supplied by IPEX.

Corzan® Full-Pressure Flange Kit

Scope

This specification covers the requirements for a Corzan® High-Pressure Flange Kit, designed and tested for use with a Corzan CPVC one-piece flange. The intent is to bring the pressure bearing capability of a Corzan CPVC one-piece flange connection up to the corresponding pressure rating of Corzan CPVC pipe. The flange kit components are manufactured in North America and meet the requirements set forth by the American Society for Testing Materials (ASTM) F1970. The Corzan CPVC one-piece flanges and Full Pressure – Stress-Saver XP gasket (75-80 Durometer Hardness) are manufactured in North America and meet the requirements set forth by the American Society for Testing Materials (ASTM) F1970 and ANSI/NSF Standard 61.

Materials

CPVC one-piece flanges manufactured by IPEX are molded from Corzan CPVC compounds. Components within Corzan Full-Pressure Flange Kit must not be substituted, the Corzan Full-Pressure Flange Kit contains the following: one (1) Full Pressure – Stress-Saver XP gasket (75-80 Durometer Hardness); one (1) Zinc-Plated Two-Piece Steel Backing Ring, complete with decal stickers informing maintenance personnel of installation requirements; four (4) or eight (8) Grade 8 Yellow Zinc Hex Cap Bolts, depending on bolt pattern of flange; four (4) or eight (8) Grade 8 Yellow Zinc Finished Hex Nuts, depending on number of bolts required; eight (8) or sixteen (16) Zinc Plated Thru Hard High Strength Flat Washers, depending on number of bolts required; one (1) installation manual. The gasket shall be certified by NSF International for use with potable water.

Dimensions and Properties

The pressure bearing capability of a one-piece IPEX Corzan CPVC flange assembled with the IPEX Corzan Full-Pressure Flange Kit meets the requirements of ASTM F1970. The flange kit can only be used with one-piece IPEX Corzan CPVC flange of the same nominal pipe size.

Marking

The marking on the IPEX one-piece Corzan CPVC flange meets the requirements of ASTM Standard F1970. The decal on the flange ring informs the end user of the proper gasket and bolts with which to install the ring, as well as the elevated pressure rating. The flange kit box includes installation instructions.

PVC SDR Pressure Rated Pipe

Scope

This specification sheet covers the manufacturers' requirements for PVC Standard Dimension Ratio (SDR) pressure rated pipe. The pipe meets or exceeds all applicable ASTM, NSF and CSA standards and is suitable for potable water.

PVC Materials

Rigid PVC (polyvinyl chloride) used in the extrusion of SDR pressure rated pipe complies with the material requirements of ASTM D1784 (formerly Type 1, Grade 1) and has a cell classification of 12454. Raw material used in the extrusion shall contain the standard specified amounts of color pigment, stabilizers and other additives. The compounds used are listed to the requirements of NSF 61 for use in potable water service.

Dimensions (Plain End)

Physical dimensions and properties of PVC SDR pressure rated pipe shall meet the requirements of ASTM D2241 (available in sizes 1/2" through 48") and CSA B137.3.

Dimensions (Bell End)

Physical dimensions and properties of PVC SDR pressure rated pipe bells shall meet the requirements of ASTM D2672 or ASTM F480.

Marking

PVC SDR rated pressure pipe is marked as prescribed in ASTM D2241 and/or CSA B137.3 as follows: IPEX; PVC; SDR# and/or the pressure rating in psi for water at 73°F (23°C); ASTM D2241; CSA B137.3; and NSF 61 potable.

Sample Specification

All PVC SDR/PR 160 and 200 pipe shall conform to ASTM D2241 and/or CSA B37.0/B137.3. Belled ends shall meet the requirements of ASTM D672 or ASTM F80. SDR pipe and Schedule 40 fittings shall be compatible and produced by one manufacturer Xirtec140 as supplied by IPEX.

PVC Ventilation Duct Pipe

Scope

This specification sheet covers the manufacturers' requirements for PVC Ventilation Duct pipe. This pipe meets or exceeds all applicable ASTM and ULC standards.

PVC Materials

Rigid PVC (polyvinyl chloride) used in the extrusion of Ventilation Duct pipe complies with the material requirements of ASTM D1784 (formerly Type 1, Grade 1) and has a cell classification of 12454.

Raw materials used in the extrusion shall contain the standard specified amounts of color pigment, stabilizers, and other additives. The compound must also exhibit a flame spread rating of 10 when tested in accordance with CAN/ULC S102.2.

Marking

PVC Ventilation Duct pipe is marked as prescribed in the above applicable standard to indicate size of pipe, material designation, compliance to standard, and manufacturer's name or trademark.

Sample Specification

All extruded PVC Ventilation Duct pipe shall be manufactured from PVC compound conforming to ASTM D1784 (formerly Type 1, Grade 1) and have a cell classification of 12454. All extruded PVC Ventilation Duct Pipe shall conform to CAN/ULC S102.2.

All pipe shall be produced by one manufacturer as supplied by IPEX.

CPVC Ventilation Duct Pipe

Scope

This specification sheet covers the manufacturers' requirements for CPVC Ventilation Duct pipe. This pipe meets or exceeds all applicable ASTM and ULC standards.

CPVC Materials

Rigid CPVC (chlorinated polyvinyl chloride) used in the extrusion of Ventilation Duct pipe complies with the material requirements of ASTM D1784 and has a cell classification of 23447.

Raw materials used in the extrusion shall contain the standard specified amounts of color pigment, stabilizers, and other additives. The compound must be Corzan grade. The compound must also exhibit a flame spread rating of 10 and a smoke development classification of 25 when tested in accordance with CAN/ULC S102.2. The Corzan CPVC compound is listed to FM 4910 "Clean Room Materials Flammability Test Protocol".

Marking

CPVC Ventilation Duct pipe is marked as prescribed in the above applicable standard to indicate size of pipe, material designation, compliance to standard, and manufacturer's name or trademark.

Sample Specification

All extruded CPVC Ventilation Duct pipe shall be manufactured from CPVC compound conforming to ASTM D1784 and have a cell classification of 23447. All extruded CPVC Ventilation Duct Pipe shall conform to CAN/ULC S102.2. The Corzan CPVC compound is listed to FM 4910 "Clean Room Materials Flammability Test Protocol".

All pipe shall be produced using Corzan compound and be produced by one manufacturer as supplied by IPEX.

Drain, Waste and Vent Pipe (DWV)

Scope

This specification sheet covers the manufacturers' requirements for PVC DWV pipe. This pipe meets or exceeds all applicable ASTM, NSF and CSA standards.

PVC Materials

Rigid PVC (polyvinyl chloride) used in the extrusion of DWV pipe complies with the material requirements of ASTM D1784 (formerly Type 1, Grade 1) and has a cell classification of 12454.

Dimensions

Physical dimensions and tolerances of PVC-DWV pipe shall meet the requirements of ASTM D2665 or CSA B181.2.

Marking

PVC DWV pipe is marked as prescribed in ASTM D2665 or CSA B181.2. The marking includes the following: IPEX; nominal pipe size; PVC-DWV; ASTM D2665, NSF 14 or CSA B181.2.

Sample Specification

All PVC DWV pipe shall conform to ASTM D1785 and/or CSA B181.2. In Canada, pipe and fittings shall be IPEX "System 15".

All pipe and fittings shall be compatible and produced by one manufacturer as supplied by IPEX.

Fabricated Fittings

Pressure Rating

The pressure rating of the fitting shall be the same as that of the pipe used in the fabrication of the fitting. The pipe shall be certified to CSA B137.3 and NSF 14.

Hydrostatic Pressure Test of Fittings

At the engineer's or customer's request, representative sample fittings may be assembled and pressure tested for 1,000 hours at 1½ times the pressure rating of the pipe at 73°F (23°C). At the end of the 1,000 hours, the pressure shall be increased to 2½ times the pressure rating within two minutes. No failure shall occur.

Quality Control Tests

Joints from fittings shall be subjected to a spark test (power source of 24,000 volts). The joint shall not permit any passage of spark at any point along the weld.

Fiberglass Reinforcing

Fiberglass reinforcing should be applied to the fitting in such a manner and thickness to meet the hydrostatic pressure requirements specified. Bonding shall be done with primer resin to provide an adequate bond to the PVC pipe.

Marking

All fittings to have an exterior label identifying size, configuration, pressure rating and manufacturer's name.

Socket Weld Depths

Each solvent weld bell must have a minimum socket depth of one-half times the pipe diameter.

One-Source Supply

All components of a piping system including pipe, fittings and valves, shall be supplied by one manufacturer as supplied by IPEX.

Joining

The PVC and CPVC pipe and socketed fittings shall be joined by use of solvent base cements manufactured in accordance with ASTM D2564. Ends of pipe shall be cut square; pipe and sockets of fittings cleaned; all dirt, grease and glossy finish removed. Joints shall be made in accordance with the pipe manufacturer's recommendations and conform to the recommended practice for making solvent-cemented joints described in ASTM D2855. The ends of pipe and sockets of fittings shall be prepared with an approved pipe primer and coated with an approved solvent cement and pushed together. Where piping is to be joined to other materials or fittings, suitable socketed adapters shall be used. Where metallic couplings or other connections are used, the manufacturer's recommendations shall be strictly adhered to.

Solvent Cementing

All socket type joints shall be made using primers and solvent cements that meet or exceed the requirements of ASTM F656 and ASTM F493 respectively. The standard practice for safe handling of primer and cement shall be in accordance with ASTM F402 and the manufacturer's material safety data sheets (MSDS). Only PVC primer and solvent cement shall be used when making PVC solvent cement joints. Only CPVC primer and solvent cement shall be used when making CPVC solvent cement joints.

Installation

Pipe and fittings shall be installed in such a manner as to accommodate movement resulting from thermal expansion or contraction. Where pipe is not free to move, expansion loops, offsets or expansion joints shall be used.

Where short offsets are made in the pipe run to clear obstructions, the pipe shall be securely anchored on both sides of the fittings to prevent stress on the joints and fittings caused by thermal expansion and contraction.

Where there are insufficient offsets to accommodate thermal expansion and contraction on long runs of pipe, and where there is not adequate space for expansion loops, mechanical expansion joints compatible with the fluid being carried shall be used.

Standard pipe hangers and supports having a broad surface at the bearing point of the pipe and free of sharp edges in contact with the pipe shall be used. The spacing of hangers shall be in accordance with the pipe manufacturer's recommendations or local authorities having jurisdiction.

All valves and equipment shall be supported independent of the pipe. Valves shall be anchored to prevent the turning moment resulting from their operation from being transmitted to the pipe.

Vertical risers shall be supported below the fitting shoulder at each 20' length. Pipe passing through walls, floors or partitions shall be sleeved and not securely anchored at these points

Testing

The water-testing requirements on any complete piping system vary dramatically depending on the operating pressure, temperature, installation conditions, jointing method and the proposed service medium. If the testing is not determined by the engineer or governed by regulatory code, the manufacturer should be contacted.



WARNING

Air or compressed gas **shall never** be used for pressure testing rigid thermoplastic piping systems.

NOTES

SECTION SIX: APPENDICES

APPENDIX A: REFERENCE TABLES AND CONVERSION CHARTS

Table A-1 Pipe Capacity

Table A-2	Weights of Water
Table A-3	Decimal & Millimeter Equivalents of Fractions
Table A-4	Volume Conversion
Table A-5	Pressure Conversion
Table A-6	Flow Conversion
Table A-7	Temperature Conversion
Table A-8	Length Conversion
Table A-9	Area Conversion
Table A-10	Weight Conversion
Table A-11	Density Conversion
Table A-12	Energy Conversion
Table A-13	Power Conversion
Table A-14	Dimensions, Weights & Pressure Ratings

APPENDIX B: USEFUL FORMULAS

- Area of a Circle
- Circumference of a Circle
- Length of Circular Arc
- Area of Circle Sector
- Equation of a Circle (cartesian coordinates)
- Equation of a Line (quadratic formula)
- Basic Trigonometric Functions
- Area of an Ellipse
- Circumference of an Ellipse
- Area of a Triangle
- Area of a Trapezoid
- Area of a Parallelogram
- Surface Area of a Sphere
- Volume of a Sphere
- Surface Area of a Cylinder
- Volume of a Cylinder
- Surface Area of an Elliptical Tank
- Volume of an Elliptical Tank
- Surface Area of a Cone
- Volume of a Cone
- Surface Area of a Rectangular Solid
- Volume of a Rectangular Solid

TABLE A-1 PIPE CAPACITY

Pipe Size (in.)	Outside Diameter – IPS OD Pipe			Volume for 1 foot length of pipe				
	inch	feet	cm	in ³	ft ³	cm ³	US Gal	Imp Gal
¼	0.250	0.021	0.098	0.589	0.0003	9.648	0.003	0.002
⅜	0.375	0.031	0.148	1.325	0.001	21.708	0.006	0.005
½	0.500	0.042	0.197	2.355	0.001	38.591	0.010	0.008
¾	0.750	0.063	0.295	5.299	0.003	86.831	0.023	0.019
1	1.000	0.083	0.394	9.420	0.005	154.366	0.041	0.034
1¼	1.250	0.104	0.492	14.719	0.009	241.196	0.064	0.053
1½	1.500	0.125	0.591	21.195	0.012	347.322	0.092	0.076
2	2.000	0.167	0.787	37.680	0.022	617.462	0.163	0.136
3	3.000	0.250	1.181	84.780	0.049	1,389.290	0.367	0.306
4	4.000	0.333	1.575	150.720	0.087	2,469.849	0.652	0.543
5	5.000	0.417	1.969	235.500	0.136	3,859.139	1.019	0.849
6	6.000	0.500	2.362	339.120	0.196	5,557.159	1.468	1.222
8	8.000	0.667	3.150	602.880	0.349	9,879.395	2.610	2.173
10	10.000	0.833	3.937	942.000	0.545	15,436.554	4.078	3.396
12	12.000	1.000	4.724	1,356.480	0.785	22,228.638	5.872	4.890
14	14.000	1.167	5.512	1,846.320	1.068	30,255.646	7.993	6.655
16	16.000	1.333	6.299	2,411.520	1.396	39,517.578	10.439	8.693
18	18.000	1.500	7.087	3,052.080	1.766	50,014.435	13.212	11.002
20	20.000	1.667	7.874	3,768.000	2.181	61,746.216	16.312	13.582
24	24.000	2.000	9.449	5,425.920	3.140	88,914.551	23.489	19.559

TABLE A-2 WEIGHTS OF WATER

Units of Volume	Weight	
	pounds	kilograms
1 US Gallon	8.350	3.791
1 Imperial Gallon	10.020	4.549
1 litre	2.210	1.003
1 cubic yard	1,685.610	765.267
1 cubic foot	62.430	28.343
1 cubic inch	0.036	0.016
1 cubic cm	0.002	0.001
1 cubic metre	2,210.000	1,000.000

TABLE A-3 DECIMAL & MILLIMETER EQUIVALENTS OF FRACTIONS

Inches		Millimeters	Inches		Millimeters
Fractions	Decimals		Fractions	Decimals	
1/64	0.015625	0.397	33/64	0.515625	13.097
1/32	0.03125	0.794	17/32	0.53125	13.494
3/64	0.046875	1.191	35/64	0.546875	13.891
1/16	0.0625	1.588	9/16	0.5625	14.288
5/64	0.078125	1.984	37/64	0.578125	14.684
3/32	0.09375	2.381	19/32	0.59375	15.081
7/64	0.109375	2.778	39/64	0.609375	15.478
1/8	0.125	3.175	5/8	0.625	15.875
9/64	0.140625	3.572	41/64	0.640625	16.272
5/32	0.15625	3.969	21/32	0.65625	16.669
11/64	0.171875	4.366	43/64	0.671875	17.066
3/16	0.1875	4.763	11/16	0.6875	17.463
13/64	0.203125	5.159	45/64	0.703125	17.859
7/32	0.21875	5.556	23/32	0.71875	18.256
15/64	0.234375	5.953	47/64	0.734375	18.653
1/4	0.250	6.350	3/4	0.750	19.050
17/64	0.265625	6.747	49/64	0.765625	19.447
9/32	0.28125	7.144	25/32	0.78125	19.844
19/64	0.296875	7.541	51/64	0.796875	20.241
5/16	0.3125	7.938	13/16	0.8125	20.638
21/64	0.328125	8.334	53/64	0.828125	21.034
11/32	0.34375	8.731	27/32	0.83475	21.431
23/64	0.359375	9.128	55/64	0.859375	21.828
3/8	0.375	9.525	7/8	0.875	22.225
25/64	0.390625	9.922	57/64	0.890625	22.622
13/32	0.40625	10.319	29/32	0.90625	23.019
27/64	0.421875	10.716	59/64	0.921875	23.416
7/16	0.4375	11.113	15/16	0.9375	23.813
29/64	0.453125	11.509	61/64	0.953125	24.209
15/32	0.46875	11.906	31/32	0.96875	24.606
31/64	0.484375	12.303	63/64	0.984375	25.003
1/2	0.500	12.700	1	1.000	25.400

TABLE A-4 VOLUME CONVERSION

Units of Volume	in ³	ft ³	yd ³	cm ³	m ³	liter	U.S. gal.	Imp. gal.
cubic inch	1	0.00058	-	16.387	-	0.0164	0.0043	0.0036
cubic foot	1728	1	0.0370	28,317.8	0.0283	28.32	7.481	6.229
cubic yard	46,656	27	1	-	0.7646	764.55	201.97	168.8
cubic centimeter	0.0610	-	-	1	-	0.001	0.0003	0.0002
cubic meter	61,023.7	35.31	1.308	-	1	1000	264.17	220.0
liter	61.02	0.0353	0.0013	1000	0.001	1	0.2642	0.22
U.S. gallon	231	0.1337	0.0050	3785.4	0.0038	3.785	1	0.8327
Imp. gallon	277.42	0.1605	0.0059	4546.1	0.0045	4.546	1.201	1

TABLE A-5 PRESSURE CONVERSION

Units of Pressure	atm	bar	lb/in ²	lb/ft ²	kg/cm ²	kg/m ²	inch H ₂ O	inch Hg	inch air	ft H ₂ O	ft air	mm Hg	mm H ₂ O	kilopascal	N/m ²
atmosphere (atm)	1	0.987	0.068	-	0.968	-	0.002	0.033	-	0.029	-	0.001	-	0.01	-
bar	1.013	1	0.069	-	0.981	-	0.002	0.034	-	0.03	-	0.001	-	0.01	-
pound per square inch (psi)	14.7	14.5	1	0.007	14.22	0.001	0.036	0.491	-	0.434	0.001	0.019	0.001	0.145	-
pound per square foot (psf)	2,116	2,089	144	1	2,048	0.205	5.2	70.73	0.006	62.43	0.076	2.784	0.205	20.89	0.021
kilogram per square centimeter	1.033	1.02	0.07	-	1	0.0001	0.003	0.035	-	0.03	-	0.001	-	0.01	-
kilogram per square meter	10,332	10,197	703	4.88	10,000	1	25.4	345.3	0.031	304.8	0.373	13.6	1	101.97	0.102
inch of water (H ₂ O) (4°C)	406.78	401.46	27.68	0.192	393.7	0.039	1	13.6	0.001	12	0.015	0.535	0.039	4.015	0.004
inch of mercury (Hg) (0°C)	29,921	29,53	2,036	0.014	28,96	0.003	0.074	1	-	0.883	0.001	0.039	0.003	0.295	-
inch of air (15°C)	332,005	327,664	22,592	148.7	321,328	32.13	816.2	11,096	1	9,794	12	436.8	32.13	3,277	3,106
foot of water (4°C)	33.9	33.46	2.307	0.016	32.81	0.003	0.083	1.133	-	1	-	0.045	0.003	0.335	-
foot of air (15°C)	27,677	27,305	1,883	13.07	26,777	2.678	0.006	924.7	0.083	816.2	1	36.4	2.678	273.1	0.273
millimeter of mercury (0°C)	760	750	51.71	0.36	735.6	0.074	1.868	25.4	0.002	22.42	0.027	1	0.074	7.5	0.008
millimeter of water (4°C)	10,332	10,197	703	4.88	10,000	1	25.4	345.3	0.031	304.8	0.373	13.6	1	101.97	0.102
kilopascal (kPa)	101.3	100	6.89	0.048	98.07	0.01	0.249	3.386	-	2.99	0.004	0.133	0.01	1	0.001
Newton per square meter	-	-	-	0.021	-	0.102	0.004	-	3.277	-	0.273	0.008	0.102	0.001	1

TABLE A-6 FLOW CONVERSION

Units of Flow Rate	US gps	US gpm	US gph	US gpd	Imp gps	Imp gpm	Imp gph	Imp gpd	liters/sec	liters/min	liters/hr	liters/day
US gal/sec (gps)	1	0.017	-	-	1.2	0.02	-	-	0.264	0.004	-	-
US gal/min (gpm)	60	1	0.017	0.001	72.06	1.2	0.02	0.001	15.85	0.264	0.004	-
US gal/hr (gph)	3,600	60	1	0.042	4,323	72.06	1.2	0.05	951.02	15.85	0.264	0.011
US gal/day (gpd)	86,400	1,440	24	1	103,762	1,729.40	28.82	1.2	22,824	380.41	6.34	0.264
Imperial gal/sec	0.833	0.014	-	-	1	0.017	-	-	0.22	0.004	-	-
Imperial gal/min	49.96	0.833	0.014	0.001	60	1	0.017	0.001	13.2	0.22	0.004	-
Imperial gal/hr	2,997.60	49.96	0.833	0.035	3,600	60	1	0.042	791.89	13.2	0.22	0.009
Imperial gal/day	71,943	1,199	19.98	0.833	86,400	1,440	24	1	19,005	316.76	5.279	0.22
Liters/sec	3.79	0.063	0.002	-	4.55	0.076	0.001	-	1	0.017	-	-
Liters/min	227.12	3.785	0.063	0.003	272.77	4.55	0.076	0.003	60	1	0.017	0.001
Liters/hr	13,627	227.12	3.785	0.158	16,366	272.77	4.55	0.189	3,600	60	1	0.042
Liters/day	327,060	5,451	90.85	3.785	392,782	6,546	109.11	4.55	86,400	1,440	24	1
Cubic ft/sec (cfs)	0.134	0.002	-	-	0.161	0.003	-	-	0.035	0.001	-	-
Cubic ft/min (cfm)	8.02	0.134	0.002	-	9.633	0.161	0.003	-	2.119	0.035	0.001	-
Cubic ft/hr (cfh)	481.25	8.02	0.134	0.006	577.96	9.63	0.161	0.007	127.13	2.119	0.035	0.001
Cubic ft/day (cfd)	11,550	192.5	3.21	0.134	13,871	231.18	3.853	0.161	3,051.20	50.85	0.848	0.001
Acre in/min	0.002	-	-	-	0.003	-	-	-	0.001	-	-	-
Acre in/hr	0.133	0.002	-	-	0.159	0.003	-	-	0.035	-	-	-
Acre in/day	3.182	0.053	0.001	-	3.821	0.064	0.001	-	0.841	0.001	-	-
Cubic m/sec	0.004	-	-	-	0.005	-	-	-	0.001	-	-	-
Cubic m/min	0.227	0.004	-	-	0.273	0.005	-	-	0.06	0.001	-	-
Cubic m/hr	13.628	0.227	0.004	-	16.366	0.273	0.005	-	3.6	0.06	0.001	-
Cubic m/day	327.06	5.451	0.091	0.004	392.78	6.546	0.109	0.005	86.4	1.44	0.024	0.001

Units of Flow Rate	ft ³ /sec	ft ³ /min	ft ³ /hr	ft ³ /day	Acre in/min	Acre in/hr	Acre in/day	m ³ /sec	m ³ /min	m ³ /hr	m ³ /day
US gal/sec (gps)	7.48	0.125	0.002	-	452.6	7.54	0.31	264.2	4.4	0.073	0.003
US gal/min (gpm)	448.8	7.48	0.125	0.005	27,154	452.6	18.86	15,850	264.2	4.403	0.183
US gal/hr (gph)	26,930	448.83	7.481	0.312	1.629E+06	27,154	1,131	951,019	15,850	264.17	11.007
US gal/day (gpd)	646,317	10,772	179.53	7.481	3.910E+07	651,703	27,154	2.282E+07	380,408	6,340	264.17
Imperial gal/sec	6.229	0.104	0.002	-	376.8	6.28	0.26	220	3.67	0.061	0.003
Imperial gal/min	373.73	6.229	0.104	0.004	22,611	376.8	15.7	13,198	220	3.666	0.153
Imperial gal/hr	22,424	373.73	6.229	0.259	1.357E+06	22,611	942.1	791,889	13,198	220	9.165
Imperial gal/day	538,171	8,970	149.49	6.229	3.256E+07	542,656	22,611	1.901E+07	316,756	5,279	220
Liters/sec	28.32	0.472	0.008	-	1,713	28.6	1.19	1,000	16.67	0.278	0.012
Liters/min	1,699	28.32	0.472	0.2	102,790	1,713	71.38	60,000	1,000	16.67	0.694
Liters/hr	101,941	1,669	28.32	1.18	6.167E+06	102,790	4,283	3.600E+06	60,000	1,000	42.67
Liters/day	2,446,575	40,776	679.6	28.32	1.480E+08	2.467E+06	102,790	8.640E+07	1.440E+06	24,000	1,000
Cubic ft/sec (cfs)	1	0.017	-	-	60.5	1.008	0.042	35.31	0.589	0.01	-
Cubic ft/min (cfm)	60	1	0.017	-	3,630	60.5	2.52	2,119	35.31	0.59	0.025
Cubic ft/hr (cfh)	3,600	60	1	0.042	217,800	3,630	151.25	127,133	2,119	35.31	1.471
Cubic ft/day (cfd)	86,400	1,440	24	1	5.227E+06	87,120	3,630	3,051,187	50,853	847.55	35.31
Acre in/min	0.017	-	-	-	1	0.017	0.001	0.584	0.01	-	-
Acre in/hr	0.992	0.001	-	-	60	1	0.042	35.02	0.584	0.01	-
Acre in/day	23.8	0.033	0.006	-	1,440	24	1	840.55	14.001	0.233	0.001
Cubic m/sec	0.028	-	-	-	1.71	0.029	0.001	1	0.017	-	-
Cubic m/min	1.7	0.028	-	-	102.8	1.71	0.071	60	1	0.017	0.001
Cubic m/hr	101.94	1.7	0.028	0.001	6,167	102.8	4.283	3,600	60	1	0.042
Cubic m/day	2446.6	40.78	0.68	0.028	148,018	2,467	102.79	86,400	1,400	24	1

TABLE A-7 TEMPERATURE CONVERSION

°F	°C	°F	°C	°F	°C	°F	°C	°F	°C
-60	-51	22	-5.6	50	10.0	78	25.6	160	71
-50	-46	23	-5.0	51	10.6	79	26.1	170	77
-40	-40	24	-4.4	52	11.1	80	26.7	180	82
-30	-34	25	-3.9	53	11.7	81	27.2	190	88
-20	-29	26	-3.3	54	12.2	82	27.8	200	92
-10	-23.0	27	-2.8	55	12.8	83	28.3	210	99
0	-17.8	28	-2.2	56	13.3	84	28.9	212	100
1	-17.2	29	-1.7	57	13.9	85	29.4	220	104
2	-16.7	30	-1.1	58	14.4	86	30.0	230	110
3	-16.1	31	-0.6	59	15.0	87	30.6	240	116
4	-15.6	32	0.0	60	15.6	88	31.1	250	121
5	-15.0	33	0.6	61	16.1	89	31.7	260	127
6	-14.4	34	1.1	62	16.7	90	32.2	270	132
7	-13.9	35	1.7	63	17.2	91	32.8	280	138
8	-13.3	36	2.2	64	17.8	92	33.3	290	143
9	-12.8	37	2.8	65	18.3	93	33.9	300	149
10	-12.2	38	3.3	66	18.9	94	34.4	310	154
11	-11.7	39	3.9	67	19.4	95	35.0	320	160
12	-11.1	40	4.4	68	20.0	96	35.6	330	166
13	-10.6	41	5.0	69	20.6	97	36.1	340	171
14	-10.0	42	5.6	70	21.1	98	36.7	350	177
15	-9.4	43	6.1	71	21.7	99	37.2	360	182
16	-8.9	44	6.7	72	22.2	100	37.8	370	188
17	-8.3	45	7.2	73	22.8	110	43	380	193
18	-7.8	46	7.8	74	23.3	120	49	390	199
19	-7.2	47	8.3	75	23.9	130	54	400	204
20	-6.7	48	8.9	76	24.4	140	60		
21	-6.1	49	9.4	77	25.0	150	66		

Degrees Celsius °C = $\frac{5}{9}$ (°F - 32)

Degrees Fahrenheit °F = $\frac{9}{5}$ °C + 32

Degrees Kelvin °T = °C + 273.2

Degrees Rankine °R = °F + 459.7

TABLE A-8 LENGTH CONVERSION

Units of Length	in.	ft.	yd.	mile	mm	cm	m	km
inch	1	0.0833	0.0278	-	25.4	2.54	0.0254	-
foot	12	1	0.3333	-	304.8	30.48	0.3048	-
yard	36	3	1	-	914.4	91.44	0.9144	-
mile	-	5280	1760	1	-	-	1609.3	1.609
millimeter	0.0394	0.0033	-	-	1	0.100	0.001	-
centimeter	0.3937	0.0328	0.0109	-	10	1	0.01	-
meter	39.37	3.281	1.094	-	1000	100	1	0.001
kilometer	-	3281	1094	0.6214	-	-	1000	1

(1 micron = 0.001 millimeter)

TABLE A-9 AREA CONVERSION

Units of Area	in ²	ft ²	acre	sq mile	cm ²	m ²	sq hectare	km ²
sq inch	1	0.0069	-	-	6.452	-	-	-
sq foot	144	1	-	-	929.0	0.0929	-	-
acre	-	43,560	1	0.0016	-	4047	0.4047	0.004
sq mile	-	2.79E+6	640	1	-	2.59E+6	259.0	2.59
sq centimeter	0.155	0.001	-	-	1	0.0001	-	-
sq meter	1550	10.76	-	-	10,000	1	0.0001	-
hectare	-	1.076E+5	2.471	0.004	-	10,000	1	0.01
sq kilometre	-	1.076E+7	247	0.386	-	1.0E+6	100	1

TABLE A-10 WEIGHT CONVERSION

Units of Weight	grain	oz	lb	ton	gram	kg	metric tonne
grain	1	-	-	-	0.0648	-	-
ounce	437.5	1	0.0625	-	28.35	0.0283	-
pound	7000	16	1	0.0005	453.6	0.4536	-
ton	-	32,000	2000	1	-	907.2	0.9072
gram	15.43	0.0353	-	-	1	0.001	-
kilogram	-	35.27	2.205	-	1000	1	0.001
metric tonne	-	35,274	2205	1.1023	-	1000	1

TABLE A-11 DENSITY CONVERSION

Units of Density	lb/in ³	lb/ft ³	lb/gal	g/cm ³	g/l
pound/cubic in.	1	1728	231.0	27.68	27,680
pound/cubic ft.	-	1	0.1337	0.0160	16.019
pound/gal.	0.00433	7.481	1	0.1198	119.83
gram/cubic cm	0.0361	62.43	8.345	1	1000.0
gram/liter	-	0.0624	0.00835	0.001	1

TABLE A-12 ENERGY CONVERSION

Units of Energy	ft lb	BTU	g cal	Joule	kw hr	hp hr
foot-pound	1	0.001285	0.3240	1.3556	-	-
British Thermal Unit	778.2	1	252.16	1054.9	-	-
gram calorie	3.0860	0.003966	1	4.1833	-	-
Int. Joule	0.7377	0.000948	0.2390	1	-	-
Int. kilowatt-hour	2,655,656	3412.8	860,563	-	1	1.3412
horsepower-hour	1,980,000	2544.5	641,617	-	0.7456	1

TABLE A-13 POWER CONVERSION

Units of Power	hp	watt	kw	BTU/sec	BTU/min	BTU/hr	ft lb/sec	ft lb/min	ft lb/hr	cal/sec	cal/min	cal/hr	j/sec	j/min	j/hr
horsepower (international)	1	0.001	1.34	1.41	0.24	-	0.002	-	0.006	-	-	-	0.001	-	-
watt	745.7	1	1,000	1,055	17.58	0.29	1.36	0.023	-	4.19	0.07	0.001	1	0.017	-
kilowatt	0.746	0.001	1	1.06	0.018	-	0.001	-	0.004	-	-	-	0.001	-	-
BTU per second	0.707	0.001	0.948	1	0.017	-	0.001	-	0.004	-	-	-	-	-	-
BTU per minute	42.41	0.057	56.87	60	1	0.017	0.077	0.001	-	0.238	0.004	-	0.057	-	-
BTU per hour	2,544	3,412	3,412	3,600	60	1	4.63	0.077	0.001	14.29	0.238	0.004	3,412	0.057	0.001
foot pound force per second	550	0.738	738	778	12.97	0.216	1	0.017	-	3.09	0.05	0.001	0.738	0.012	-
foot pound force per minute	33,000	44.25	44,254	46,690	778	12.97	60	1	0.017	185.3	3.09	0.05	44.25	0.738	0.012
foot pound force per hour	1.980E+06	2,655	2.655E+06	2.801E+06	46.69	778	3,600	60	1	11,117	185.28	3.09	2,655	44.25	0.738
calories per second	178	0.239	238.9	252	4.2	0.07	0.324	0.005	-	1	0.017	-	0.239	0.004	-
calories per minute	10,686	14.33	14,331	15,120	252	4.2	19.43	0.324	0.005	60	1	0.017	14.33	0.239	0.004
calories per hour	641,186	859.85	859,845	907,185	15,120	252	1,166	19.43	0.324	3,600	60	1	860	14.33	0.239
joules per second	746	1	1,000	1,055	17.58	0.29	1.36	0.023	-	4.19	0.07	0.001	1	0.017	-
joules per minute	44,742	60	60,000	63,303	1,055	17.58	81.35	1.36	0.023	251.2	4.19	0.07	60	1	0.017
joules per hour	2.685E+06	3,600	3.600E+06	3.798E+06	63,303	1,055	4,881	81.35	1.36	15,072	251.2	4.19	3,600	60	1

TABLE A-14 DIMENSIONS, WEIGHTS & PRESSURE RATINGS FOR PVC & CPVC PIPE

Schedule (DR) SDR	Nominal Pipe Size		Outside Diameter		Max Working Pressure		Min Wall Thickness		Avg Inside Diameter		Weight of pipe CPVC		Weight of pipe PVC	
	in	mm	in	mm	psi	kPa	in	mm	in	mm	lbs/ft	kg/m	lbs/ft	kg/m
Sch 80 (DR 4.5)	1/4	6	0.540	13.7	1130	7 790	0.119	3.02	.302	7.67	-	-	0.10	0.150
Sch 80 (DR 5.4)	3/8	10	0.675	17.1	920	6 340	0.126	3.20	.423	10.74	-	-	0.14	0.210
Sch 40 (DR 8)	1/2	12	0.840	21.3	600	4 140	0.109	2.76	.602	15.26	0.18	0.269	0.17	0.253
Sch 80 (DR 6)					850	5 860	0.147	3.72	.526	13.34	0.22	0.335	0.21	0.313
SDR 21					200	1 380	0.080	2.02	.660	16.74	-	-	0.13	0.193
Sch 40 (DR 10)	3/4	20	1.050	26.70	480	3 300	0.113	2.86	.804	20.46	0.24	0.354	0.22	0.327
Sch 80 (DR 7)					690	4 760	0.154	3.90	.722	18.38	0.31	0.456	0.28	0.417
SDR 21					200	1 380	0.080	2.02	.870	22.14	-	-	0.13	0.194
Sch 40 (DR 10)	1	25	1.315	33.40	450	3 100	0.133	3.38	1.029	26.14	0.35	0.522	0.33	0.491
Sch 80 (DR 8)					630	4 340	0.179	4.54	.936	23.78	0.45	0.663	0.41	0.610
SDR 21					200	1 380	0.080	2.02	1.135	28.84	-	-	0.21	0.313
Sch 40 (DR 12)	1 1/4	32	1.660	42.15	370	2 550	0.141	3.56	1.360	34.53	0.47	0.705	0.44	0.655
Sch 80 (DR 9)					520	3 590	0.191	4.84	1.255	31.87	0.62	0.919	0.57	0.848
SDR 21					200	1 380	0.080	2.02	1.480	37.59	-	-	0.27	0.402
Sch 40 (DR 13)	1 1/2	40	1.900	48.25	330	2 280	0.145	3.68	1.590	40.37	0.57	0.843	0.52	0.774
Sch 80 (DR 10)					470	3 240	0.200	5.08	1.476	37.49	0.75	1.115	0.69	1.026
SDR 21					200	1 380	0.090	2.28	1.700	43.17	-	-	0.35	0.521
SDR 26					160	1 100	0.080	2.02	1.720	43.69	-	-	0.32	0.476
Sch 40 (DR 16)	2	50	2.375	60.35	280	1 930	0.154	3.90	2.047	52.03	0.76	1.129	0.70	1.042
Sch 80 (DR 11)					400	2 760	0.218	5.54	1.913	48.61	1.04	1.545	0.96	1.429
SDR 21					200	1 380	0.113	2.86	2.129	54.11	-	-	0.54	0.804
SDR 26					160	1 100	0.091	2.30	2.173	55.23	-	-	0.45	0.670
Sch 40 (DR 14)	2 1/2	65	2.875	73.00	300	2 070	0.203	5.16	2.445	62.08	1.20	1.781	1.11	1.652
Sch 80 (DR 11)					420	2 900	0.276	7.00	2.290	58.16	1.58	2.356	1.46	2.173
SDR 21					200	1 380	0.137	3.48	2.581	65.54	-	-	0.78	1.161
SDR 26					160	1 100	0.110	2.78	2.635	66.92	-	-	0.64	0.952
Sch 40 (DR 16)	3	75	3.500	88.90	260	1 790	0.216	5.48	3.042	77.28	1.57	2.336	1.45	2.158
Sch 80 (DR 12)					370	2 550	0.300	7.62	2.864	72.74	2.12	3.153	1.96	2.917
SDR 21					200	1 380	0.167	4.24	3.146	79.92	-	-	1.14	1.697
SDR 26					160	1 100	0.135	3.42	3.210	81.54	-	-	0.94	1.399
SDR 32.5					125	860	0.108	2.74	3.264	82.90	-	-	0.77	1.146
SDR 41					100	690	0.085	2.16	3.310	84.08	-	-	0.63	0.938
Sch 40 (DR 19)	4	100	4.500	114.30	220	1 520	0.237	6.02	3.998	101.58	2.23	3.323	2.07	3.081
Sch 80 (DR 13)					320	2 210	0.337	8.56	3.786	96.16	3.10	4.610	2.87	4.271
SDR 21					200	1 380	0.214	5.44	4.046	102.76	-	-	1.88	2.798
SDR 26					160	1 100	0.173	4.38	4.133	105.00	-	-	1.54	2.292
SDR 32.5					125	860	0.138	3.50	4.204	106.78	-	-	1.25	1.860
SDR 41					100	690	0.110	2.78	4.260	108.22	-	-	1.02	1.518
Sch 40 (DR 22)	5	125	5.563	141.30	190	1 310	0.258	6.54	5.016	127.42	-	-	2.81	4.182
Sch 80 (DR 15)					290	2 000	0.375	9.52	4.768	121.12	-	-	4.02	5.982
SDR 21					200	1 380	0.265	6.72	5.001	127.04	-	-	2.88	4.286
SDR 26					160	1 100	0.214	5.44	5.107	129.74	-	-	2.35	3.497
SDR 32.5					125	860	0.171	4.34	5.199	132.08	-	-	1.89	2.813
SDR 41					100	690	0.136	3.44	5.271	133.90	-	-	1.53	2.277
Sch 40 (DR 24)	6	150	6.625	168.30	180	1 240	0.280	7.10	6.031	153.22	3.93	5.853	3.65	5.432
Sch 80 (DR 16)					280	1 930	0.432	10.96	5.709	145.04	5.91	8.793	5.48	8.155
SDR 21					200	1 380	0.315	8.02	5.955	151.28	-	-	4.09	6.087
SDR 26					160	1 100	0.255	6.48	6.084	154.56	-	-	3.33	4.956
SDR 32.5					125	860	0.204	5.18	6.193	157.32	-	-	2.69	4.003
SDR 41					100	690	0.161	4.12	6.281	159.56	-	-	2.15	3.200

psi @ 73°F

kPa @ 23°C

weight of pipe is for plain end

TABLE A-14 DIMENSIONS, WEIGHTS & PRESSURE RATINGS FOR PVC & CPVC PIPE

Schedule (DR) SDR	Nominal Pipe Size		Outside Diameter		Max Working Pressure		Min Wall Thickness		Avg Inside Diameter		Weight of pipe CPVC		Weight of pipe PVC	
	in	mm	in	mm	psi	kPa	in	mm	in	mm	lbs/ft	kg/m	lbs/ft	kg/m
Sch 40 (DR 27)	8	200	8.625	219.05	160	1 100	0.322	8.18	7.941	201.71	5.92	8.812	5.50	8.185
Sch 80 (DR 17)					250	1 720	0.500	12.70	7.565	192.13	8.98	13.366	8.32	12.382
SDR 21					200	1 380	0.411	10.40	7.756	196.99	-	-	6.91	10.283
SDR 26					160	1 100	0.332	8.42	7.921	201.79	-	-	5.65	8.408
SDR 32.5					125	860	0.266	6.72	8.063	204.79	-	-	4.55	6.771
SDR 41					100	690	0.210	5.32	8.180	207.77	-	-	3.63	5.402
Sch 40 (DR 30)					10	250	10.750	273.05	140	970	0.365	9.26	9.976	253.41
Sch 80 (DR 18)	230	1 590	0.593	15.06					9.493	241.13	13.32	19.816	11.81	17.576
SDR 21	200	1 380	0.512	12.98					9.667	245.55	-	-	10.73	15.968
SDR 26	160	1 100	0.413	10.48					9.874	250.81	-	-	8.76	13.036
SDR 32.5	125	860	0.331	8.40					10.048	255.23	-	-	7.08	10.536
SDR 41	100	690	0.262	6.66					10.195	258.95	-	-	5.64	8.393
Sch 40 (DR 32)	12	300	12.750	323.90					130	900	0.406	10.30	11.888	302.04
Sch 80 (DR 19)					230	1 590	0.687	17.44	11.294	286.92	18.35	27.310	16.98	25.269
SDR 21					200	1 380	0.607	15.38	11.465	291.28	-	-	15.10	22.471
SDR 26					160	1 100	0.490	12.44	11.711	297.52	-	-	12.35	18.379
SDR 32.5					125	860	0.392	9.96	11.919	302.78	-	-	9.94	14.792
SDR 41					100	690	0.311	7.90	12.091	307.16	-	-	7.94	11.816
Sch 40 (DR 32)					14	350	14.000	355.60	130	910	0.438	11.13	13.072	332.03
Sch 80 (DR 19)	220	1 540	0.750	19.05					12.412	315.22	21.96	32.680	20.34	30.270
SDR 21	200	1 380	0.665	16.88					12.590	319.80	-	-	18.18	27.065
SDR 26	160	1 100	0.538	13.66					12.859	326.62	-	-	14.88	22.144
SDR 32.5	125	860	0.431	10.76					13.100	332.78	-	-	11.83	17.615
SDR 41	100	690	0.342	8.66					13.277	337.24	-	-	9.58	14.260
Sch 40 (DR 32)	16	400	16.000	406.40					130	910	0.500	12.70	14.936	379.38
Sch 80 (DR 19)					220	1 540	0.843	21.41	14.224	361.29	28.09	41.801	26.03	38.74
SDR 21					200	1 380	0.760	19.30	14.388	365.48	-	-	23.76	35.36
SDR 26					160	1 100	0.615	15.62	14.696	373.28	-	-	19.41	28.89
SDR 32.5					125	860	0.492	12.32	14.970	380.24	-	-	15.47	22.99
SDR 41					100	690	0.391	9.90	15.172	385.38	-	-	12.52	18.63
Sch 40 (DR 32)					18	450	18.000	457.20	130	910	0.562	14.27	16.809	429.46
Sch 80 (DR 19)	220	1 540	0.937	23.80					16.014	406.76	-	-	32.76	48.75
SDR 21	200	1 380	0.857	21.72					16.182	411.14	-	-	30.11	44.81
SDR 26	160	1 100	0.693	17.60					16.531	419.88	-	-	24.62	36.64
SDR 32.5	125	860	0.554	14.06					16.825	427.36	-	-	19.86	29.55
SDR 41	100	690	0.440	11.14					17.065	433.46	-	-	15.92	23.69
Sch 40 (DR 34)	20	500	20.000	508.00					120	840	0.593	15.06	18.743	476.07
Sch 80 (DR 19)					220	1 450	1.031	26.19	17.814	452.48	-	-	40.09	59.66
SDR 21					200	1 380	0.952	24.12	17.982	456.86	-	-	37.17	55.32
SDR 26					160	1 100	0.770	19.56	18.368	466.54	-	-	30.37	45.20
SDR 32.5					125	860	0.615	15.62	18.696	474.88	-	-	24.47	36.42
SDR 41					100	690	0.489	12.42	18.963	481.66	-	-	19.61	29.18
Sch 40 (DR 35)					24	600	24.000	609.60	120	840	0.687	17.45	22.544	572.62
Sch 80 (DR 20)	210	1 470	1.218	30.94					21.418	544.02	-	-	56.88	84.65
SDR 21	200	1 380	1.143	28.96					21.576	548.20	-	-	53.54	79.68
SDR 26	160	1 100	0.924	23.46					22.041	559.86	-	-	43.77	65.14
SDR 32.5	125	860	0.740	18.80					22.431	569.74	-	-	35.35	52.61
SDR 41	100	690	0.585	14.86					22.760	578.10	-	-	28.12	41.84

psi @ 73°F

kPa @ 23°C

weight of pipe is for plain end

APPENDIX B: USEFUL FORMULAS

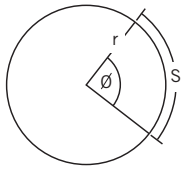

Circle

$$\text{Diameter} = 2R$$

$$\text{Circumference} = \pi D = 2\pi R$$

$$\text{Area} = \pi R^2$$

Length of Circular Arc

$$S = \theta \times \left(\frac{\pi}{180} \right) \times r \quad \theta \text{ in degrees}$$

$$S = \theta \times r \quad \theta \text{ in radians}$$

Area of Circle Sector

$$A = \theta \times \left(\frac{\theta}{360} \right) \times \pi \times r^2 \quad \theta \text{ in degrees}$$

$$A = \theta \times \left(\frac{\theta}{2} \right) \times r^2 \quad \theta \text{ in radians}$$

Equation of a Circle (cartesian co-ordinates)

- for a circle with center (j, k) and radius (r)

$$(x - j)^2 + (y - k)^2 = r^2$$

Equation of a line (quadratic formula)

$$ax + by + c = 0$$

or

$$ax^2 + bx + c = 0$$

$$x = \frac{-b \pm \sqrt{b^2 - 4ac}}{2a}$$

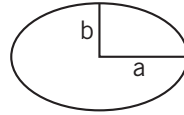

Ellipse

$$\text{Area} = \pi \times a \times b$$

$$\text{Circumference} = \frac{1 + 4(a-b)^2}{((3a + 5b)(5a + 3b))}$$

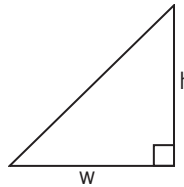

Triangle

$$\text{Area} = \frac{w \times h}{2}$$

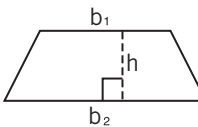

Trapezoid

$$\text{Area} = \frac{1}{2} (b_1 + b_2) \times h$$

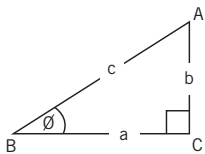

Trigonometry

$$\sin \theta = \frac{b}{c}$$

$$\cos \theta = \frac{a}{c}$$

$$\tan \theta = \frac{b}{a}$$

Sine Law

$$\frac{a}{\sin A} = \frac{b}{\sin B} = \frac{c}{\sin C} = 2R$$

Cosine Law

$$c^2 = a^2 + b^2 - 2ab \cos C$$

$$b^2 = a^2 + c^2 - 2ac \cos B$$

$$a^2 = b^2 + c^2 - 2bc \cos A$$

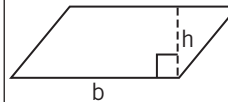

Parallelogram

$$\text{Area} = b \times h$$

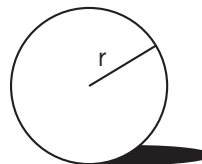

Sphere

$$\text{Surface Area} = 4 \pi r^2$$

$$\text{Volume} = \frac{4}{3} \pi r^3$$

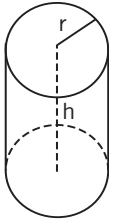

Cylinder

$$\text{Surface Area} = (2 \pi r^2) + (2 \pi r h)$$

$$\text{Volume} = \pi r^2 h$$

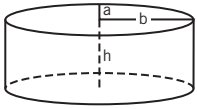

Elliptical Tank

$$\text{Surface Area} = 2 \pi \left(\frac{\sqrt{a^2 + b^2}}{2} \right) h + (2\pi ab)$$

$$\text{Volume} = \pi abh$$

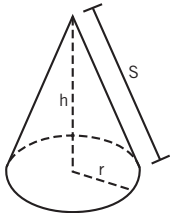

Cone

$$\text{Surface Area} = \pi r s$$

$$\text{Volume} = \pi r^2 \times \frac{h}{3}$$

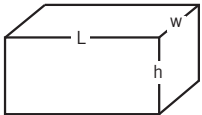

Rectangular Solid

$$\text{Surface Area} = 2 (Lw + Lh + wh)$$

$$\text{Volume} = L \times w \times h$$

APPENDIX C: GLOSSARY

Acceptance test An investigation performed on an individual lot of a previously qualified product, by, or under the observation of, the purchaser to establish conformity with a purchase agreement.

Acrylonitrile-butadiene-styrene (ABS) pipe and fitting plastics Plastics containing polymers and/or blends of polymers, in which the minimum butadiene content is 6 percent, the minimum acrylonitrile content is 15 percent, the minimum styrene and/or substituted styrene content is 15 percent, and the maximum content of all other monomers is not more than 5 percent, and lubricants, stabilizers and colorants.

Adhesive A substance capable of holding materials together by surface attachment.

Adhesive, solvent An adhesive having a volatile organic liquid as a vehicle. See Solvent Cement.

Antioxidant An additive to retard possible degradation from contact with oxygen (air), particularly in processing at or exposures to high temperatures.

Artificial weathering The exposure of plastics to cyclic laboratory conditions involves changes in temperature, relative humidity, and ultraviolet radiant energy, with or without direct water spray, in an attempt to produce changes in the material similar to those observed after long-term continuous outdoor exposure.

Note: The laboratory exposure conditions are more intense than encountered in actual outdoor exposure to achieve an accelerated effect. This definition does not involve exposure to special conditions such as ozone, salt spray, industrial gases, etc.

Bell end The enlarged portion of a pipe that resembles the socket portion of a fitting and that is intended to be used to make a joint by inserting a piece of pipe into it. Joining may be accomplished by solvent cements, adhesives, or mechanical techniques.

Beam loading The application of a load to a pipe between two points of support, usually expressed in pounds and the distance between the centers of the supports.

Burst strength The internal pressure required to break a pipe or fitting. This pressure will vary with the rate of build-up of the pressure and the time during which the pressure is held.

Butylene plastics Plastics based on resins made by polymerization of butene or copolymerization of butene with one or more unsaturated compounds, the butene being in the greatest amount by weight.

Cellulose acetate butyrate plastics Plastic made by compounding a cellulose acetate butyrate ester with plasticizers and other ingredients. Cellulose acetate butyrate ester is a derivative of cellulose (obtained from cotton and/or wood pulp) made by converting some of the hydroxyl groups in cellulose to acetate and butyrate groups with chemicals.

Cement See Adhesive and Solvents, Cement.

Chemical resistance (1) The effect of specific chemicals on the properties of plastic piping with respect to concentration, temperature and time of exposure.

Chemical resistance (2) The ability of a specific plastic pipe to render service for a useful period in the transport of a specific chemical at a specified concentration and temperature.

Cold flow See Creep.

Compound The intimate admixture of a polymer or polymers with other ingredients such as fillers, softeners, plasticizers, catalysts, pigments, dyes, curing agents, stabilizers, antioxidants, etc.

Creep, n. The time-dependent part of strain resulting from stress, that is, the dimensional change caused by the application of load over and above the elastic deformation and with respect to time.

Cure, v. To change the properties of a polymeric system into a final, more stable, usable condition by the use of heat, radiation or reaction with chemical additives.

Deflection temperature The temperature at which a specimen will deflect a given distance at a given load under prescribed conditions of test. See ASTM D648. Formerly called heat distortion.

Degradation, n. A breakdown of a chemical structure of a plastic. See also Deterioration.

Deterioration A permanent change in the physical properties of a plastic evidenced by impairment of these properties.

Diffusion, n. The movement of a material, such as a gas or liquid, in the body of a plastic. If the gas or liquid is absorbed on one side of a piece of plastic and given off on the other side, the phenomenon is called permeability. Diffusion and permeability are not due to holes or pores in the plastic but are caused and controlled by chemical mechanisms.

Dimension ratio The diameter of a pipe divided by the wall thickness. Each pipe can have two dimension ratios depending on whether the outside or inside diameter is used. In practice, the outside diameter is used if the standards requirement and manufacturing control are based on this diameter. The inside diameter is used when this measurement is the controlling one.

Dry-Blend A free-flowing dry compound prepared without fluxing or addition of solvent.

Elasticity That property of plastics materials by virtue of which they tend to recover their original size and shape after deformation.

Note: If the strain is proportional to the applied stress, the material is said to exhibit Hookean or ideal elasticity.

Elastomer A material which at room temperature can be stretched repeatedly to at least twice its original length and, upon immediate release of the stress, will return with force to its approximate original length.

Elevated temperature testing Tests on plastic pipe above 23°C (73°F).

Environmental stress cracking Cracks that develop when the material is subjected to stress in the presence of specific chemicals.

Ethylene plastics Plastics based on resins made by the polymerization of ethylene or copolymerization of ethylene with one or more other unsaturated compounds, the ethylene being in greatest amount by weight.

Extrusion A method whereby heated or unheated plastic forced through a shaping orifice becomes one continuously formed piece.

Failure, adhesive Rupture of an adhesive bond, such that the place of separation appears to be at the adhesive-adherence interface.

Filler A relatively inert material added to a plastic to modify its strength, permanence, working properties, or other qualities, or to lower costs. See also Reinforced plastic.

Forming A process in which the shape of plastic pieces such as sheets, rods or tubes is changed to a desired configuration. See also Thermoforming.

Note: The use of the term “forming” in plastics technology does not include such operations as molding, casting or extrusion, in which shapes or pieces are made from molding materials or liquids.

Fungi resistance The ability of plastic pipe to withstand fungi growth and/or their metabolic products under normal conditions of service or laboratory tests simulating such conditions.

Heat distortion See Deflection temperature.

Heat forming See Thermoforming.

Heat joining Making a pipe joint by heating the edges of the parts to be joined so that they fuse and become essentially one piece with or without the use of additional material.

Hoop stress The tensile stress, usually in pounds per square inch (psi), in the circumferential orientation in the wall of the pipe when the pipe contains a gas or liquid under pressure.

Hydrostatic design stress The estimated maximum tensile stress in the wall of the pipe in the circumferential orientation due to internal hydrostatic pressure that can be applied continuously with a high degree of certainty that failure of the pipe will not occur.

Hydrostatic strength (quick) The hoop stress calculated by means of the ISO equation at which the pipe breaks due to an internal pressure build-up, usually within 60 to 90 seconds.

Long-term burst The internal pressure at which a pipe or fitting will break due to a constant internal pressure held for 100,000 hours (11.43 years).

Impact, izod A specific type of impact test made with a pendulum type machine. The specimens are molded or extruded with a machined notch in the center. See ASTM D 256.

Impact, tup A falling weight (tup) impact test developed specifically for pipe and fittings. There are several variables that can be selected. See ASTM D 2444.

ISO equation An equation showing the interrelations between stress, pressure and dimensions in pipe, namely

$$S = \frac{P (ID + t)}{2t} \quad \text{or} \quad \frac{P(OD - t)}{2t}$$

where S = stress

P = pressure

ID = average inside diameter

OD = average outside diameter

t = minimum wall thickness

Joint The location at which two pieces of pipe or a pipe and a fitting are connected together. The joint may be made by an adhesive, a solvent-cement or a mechanical device such as threads or a ring seal.

Long-term hydrostatic strength The estimated tensile stress in the wall of the pipe in the circumferential orientation (hoop stress) that when applied continuously will cause failure of the pipe at 100,000 hours (11.43 years). These strengths are usually obtained by extrapolation of log-log regression equations or plots.

Molding, compression A method of forming objects from plastics by placing the material in a confining mold cavity and applying pressure and usually heat.

Molding, injection A method of forming plastic objects from granular or powdered plastics by the fusing of plastic in a chamber with heat and pressure and then forcing part of the mass into a cooler chamber where it solidifies.

Note: This method is commonly used to form objects from thermoplastics.

Monomer A starting material from which the polymer is formed. See also Polymer.

Nylon plastics Plastics based on resins composed principally of a long-chain synthetic polymeric amide which has recurring amide groups as an integral part of the main polymer chain.

Olefin plastics Plastics based on resins made by the polymerization of olefins or copolymerization of olefins with other unsaturated compounds, the olefins being in greatest amount by weight. Polyethylene, polypropylene and polybutylene are the most common olefin plastics encountered in pipe.

Outdoor exposure Plastic pipe placed in service or stored so that it is not protected from the elements of normal weather conditions, i.e., the sun's rays, rain, air and wind. Exposure to industrial and waste gases, chemicals, engine exhausts, etc. are not considered normal "outdoor exposure".

Permanence The property of a plastic which describes its resistance to appreciable changes in characteristics with time and environment.

Permeability See Diffusion.

Plastic, n. A material that contains as an essential ingredient an organic substance of large molecular weight, is solid in its finished state, and, at some stage in its manufacture or in its processing into finished articles, can be shaped by flow.

Plastic, adj. The adjective plastic indicates that the noun modified is made of, consists of, or pertains to plastic.

Plasticizer A material incorporated in a plastic to increase its workability and its flexibility or distensibility.

Note: The addition of the plasticizer may lower the melt viscosity, the temperature of the second-order transition, or the elastic modulus of the plastic.

Plastics conduit Plastic pipe or tubing used as an enclosure for electrical wiring.

Plastics pipe A hollow cylinder of a plastic material in which the wall thicknesses are usually small when compared to the diameter and in which the inside and outside walls are essentially concentric. See Plastics tubing.

Plastics tubing A particular size of plastics pipe in which the outside diameter is essentially the same as that of copper tubing. See Plastics pipe.

Polyethylene, n. A polymer prepared by the polymerization of ethylene as the sole monomer. See Polyethylene plastics and Ethylene plastics.

Polyethylene plastics Plastics based on polymers made with ethylene as essentially the sole monomer.

Note: In common usage for this plastic, essentially means no less than 85% ethylene and no less than 95% total olefins.

Polymer A compound formed by the reaction of simple molecules having functional groups that permit their combination to proceed to high molecular weights under suitable conditions. Polymers may be formed by polymerization (addition polymer) or polycondensation (condensation polymer). When two or more monomers are involved, the product is called a copolymer.

Polymerization A chemical reaction in which the molecules of a monomer are linked together to form large molecules whose molecular weight is a multiple of that of the original substance. When two or more monomers are involved, the process is called copolymerization or heteropolymerization.

Polyolefin, n. A polymer prepared by the polymerization of an olefin(s) as the sole monomer(s). See Polyolefin plastics and Olefin plastics.

Polyolefin plastics Plastics based on polymers made with an olefin(s) as essentially the sole monomer(s).

Polypropylene, n. A polymer prepared by the polymerization of propylene as the sole monomer. See Polypropylene plastics and Propylene plastics.

Polypropylene plastics Plastics based on polymers made with propylene as essentially the sole monomer.

Polystyrene A plastic based on a resin made by polymerization of styrene as the sole monomer. See Styrene plastics.

Note: Polystyrene may contain minor proportions of lubricants, stabilizers, fillers, pigments and dyes.

Poly (vinyl chloride) A resin prepared by the polymerization of vinyl chloride with or without the addition of small amounts of other monomers.

Poly (vinyl chloride) plastics Plastics made by combining poly (vinyl chloride) with colorants, fillers, plasticizers, stabilizers, lubricants, other polymers, and other compounding ingredients. Not all of these modifiers are used in pipe compounds.

Powder blend See Dry-Blend.

Pressure When expressed with reference to pipe the force per unit area exerted by the medium in the pipe.

Pressure rating The estimated maximum pressure that the medium in the pipe can exert continuously with a high degree of certainty that failure of the pipe will not occur.

Propylene plastics Plastics based on resins made by polymerization of propylene or copolymerization of propylene with one or more other unsaturated compounds, the propylene being in greatest amount by weight.

Qualification test An investigation, independent of a procurement action, performed on a product to determine whether or not the product conforms to all requirements of the applicable specification.

Note: The examination is usually conducted by the agency responsible for the specification, the purchaser, or by a facility approved by the purchaser, at the request of the supplier seeking inclusion of his product on a qualified products list.

Quick burst The internal pressure required to burst a pipe or fitting due to an internal pressure build-up, usually within 60 to 70 seconds.

Reinforced plastic A plastic with some strength properties greatly superior to those of the base resin, resulting from the presence of high strength fillers imbedded in the composition. See also Filler.

Resin A solid, semisolid, or pseudosolid organic material which has an indefinite and often high molecular weight, exhibits a tendency to flow when subjected to stress, usually has a softening or melting range and usually fractures conchoidally.

Reworked material (thermoplastic) A plastic material that has been reprocessed, after having been previously processed by molding, extrusions, etc., in a fabricator's plant.

Rubber A material that is capable of recovering from large deformations quickly and forcibly. See Elastomer.

Sample A small part or portion of a plastic material or product intended to be representative of the whole.

Saran plastics Plastics based on resins made by the polymerization of vinylidene chloride or copolymerization of vinylidene chloride with other unsaturated compounds, the vinylidene chloride being in greatest amount of weight.

Schedule A pipe size system (outside diameters and wall thicknesses) originated by the steel pipe industry.

Self-extinguishing The ability of a plastic to resist burning when the source of heat or flame that ignited it is removed.

Service factor A factor which is used to reduce a strength value to obtain an engineering design stress. The factor may vary depending on the service conditions, the hazard, the length of service desired and the properties of the pipe.

Set To convert an adhesive into a fixed or hardened state by chemical or physical action, such as condensation, polymerization, oxidation, vulcanization, gelation, hydration, or evaporation of volatile constituents. See also Cure.

Softening range The range of temperature in which a plastic changes from a rigid to a soft nature.

Note: Actual values will depend on the method of test. Sometimes referred to as softening point.

Solvent cement In the plastic piping field, a solvent adhesive that contains a solvent that dissolves or softens the surfaces being bonded so that the bonded assembly becomes essentially one piece of the same type of plastic.

Solvent cementing Is the making of a pipe joint with a solvent cement. See Solvent cement.

Specimen An individual piece or portion of a sample used to make a specific test. Specific tests usually require specimens of specific shape and dimensions.

Stabilizer A compounding ingredient added to a plastic composition to retard possible degradation on exposure to high temperatures, particularly in processing. An antioxidant is a specific kind of stabilizer.

Standard dimension ratio A selected series of numbers in which the dimension ratios are constants for all sizes of pipe for each standard dimension, ratio and which are the USASI Preferred Number Series 10 modified by +1 or -1. If the outside diameter (OD) is used the modifier is +1. If the inside diameter (ID) is used the modifier is -1.

Standard thermoplastic pipe materials designation code A means for easily identifying a thermoplastic pipe material by means of three elements. The first element is the abbreviation for the chemical type of the plastic in accordance with ASTM D 1600. The second is the type and grade (based on properties in accordance with the ASTM materials specification): in the case of ASTM specifications which have no types and grades or those in the cell structure system, two digit numbers are assigned by the PPI that are used in place of the larger numbers. The third is the recommended hydrostatic design stress (RHDS) for water at 23°C (73°F) in pounds per square inch divided by 100 and with decimals dropped, e.g. PVC 1120 indicates that the plastic is poly (vinyl chloride), Type 1, Grade 1 according to ASTM D 1784 with a RHDS of 2000 psi for water at 73°F. PE 3306 indicates that the plastic is polyethylene. Type III Grade 3 according to ASTM D 1248 with a RHDS of 630 psi for water at 73°F. PP 1208 is polypropylene. Class I-19509 in accordance with ASTM D 2146 with a RHDS of 800 psi for water at 73°F; the designation of PP 12 for polypropylene Class I-19509 will be covered in the ASTM and Products Standards for polypropylene pipe when they are issued.

Stiffness factor A physical property of plastic pipe that indicates the degree of flexibility of the pipe when subjected to external loads. See ASTM D 2413.

Strain The ratio of the amount of deformation to the length being deformed caused by the application of a load on a piece of material.

Strength The stress required to break, rupture or cause a failure.

Stress When expressed with reference to pipe the force per unit area in the wall of the pipe in the circumferential orientation due to internal hydrostatic pressure.

Stress-crack External or internal cracks in the plastic caused by tensile stresses less than that of its short-term mechanical strength.

Note: The development of such cracks is frequently accelerated by the environment to which the plastic is exposed. The stresses which cause cracking may be present internally or externally or may be combinations of these stresses. The appearance of a network of fine cracks is called crazing.

Stress relaxation The decrease of stress with respect to time in a piece of plastic that is subject to an external load.

Styrene plastics Plastics based on resins made by the polymerization of styrene or copolymerization of styrene with other unsaturated compounds, the styrene being in greatest amount by weight.

Styrene-rubber (SR) pipe and fitting plastics Plastics containing at least 50 percent styrene plastics combined with rubbers and other compounding materials, but not more than 15 percent acrylonitrile.

Styrene-rubber plastics Compositions based on rubbers and styrene plastics, the styrene plastics being in greatest amount by weight.

Sustained pressure test A constant internal pressure test for 1000 hours.

Thermoforming Forming with the aid of heat. See also Forming.

Thermoplastic, n. A plastic which is thermoplastic in behavior.

Thermoplastic, adj. Capable of being repeatedly softened by increase of temperature and hardened by decrease of temperature.

Note: Thermoplastic applies to those materials whose change upon heating is substantially physical.

Thermoset, n. A plastic which, when cured by application of heat or chemical means, changes into a substantially infusible and insoluble product.

Thermoset, adj. Pertaining to the state of a resin in which it is relatively infusible.

Thermosetting Capable of being changed into a substantially infusible or insoluble product when cured under application of heat or chemical means.

Vinyl A plastic material

Virgin material A plastic material in the form of pellets, granules, powder, floc or liquid that has not been subjected to use or processing other than that required for its original manufacture.

Weld - or Knit-line A mark on a molded plastic formed by the union of two or more streams of plastic flowing together.

AGA - American Gas Association

APPENDIX D: ABBREVIATIONS

ANSI	- American National Standards Institute
API	- American Petroleum Institute
ASME	- American Society of Mechanical Engineers
ASTM	- American Society for Testing and Materials
AWWA	- American Water Works Association
BOCA	- Building Officials and Code Administrators
BS	- British Standards Institution
CPVC	- Chlorinated poly (vinyl chloride) plastic or resin
CS	- Commercial Standard, see Product Standard
CSA	- Canadian Standards Association
DR	- Dimension Ratio
DIN	- German Industrial Norms
FHA	- Federal Housing Administration or Farmers Home Administration
HDB	- Hydrostatic design basis
HDS	- Hydrostatic design stress
IAPD	- International Association of Plastics Distributors
IAPMO	- International Association of Plumbing and Mechanical Officials
IPC	- International Plumbing Code
ISO	- International Standards Organization
JIS	- Japanese Industrial Standards
NSF	- National Sanitation Foundation International
PPI	- Plastics Pipe Institute
PS	- Product Standard when in reference to a specification for plastic pipe and fittings. These specifications are promulgated by the U.S. Department of Commerce and were formerly known as Commercial Standards.
PSI	- Pounds per square inch
PSIG	- Gage pressure in pounds per square inch
PVC	- Poly (vinyl chloride) plastic or resin
RVCM	- Residual Vinyl Chloride Monomer
SCS	- Soil Conservation Service
SDR	- Standard Dimension Ratio
SI	- International System of Units
SPI	- Society of the Plastics Industry, Inc.
UPC	- Uniform Plumbing Code
USASI	- United States of America Standards Institute (formerly American Standards Association)
WOG	- Water, Oil, Gas

Table 1 – Physical Properties

APPENDIX E: TABLES AND FIGURES

- Table 2 – Nominal DR Classification for PVC and CPVC Schedule Pipe
- Table 3 – Flow Coefficient Constants (C)
- Table 4 – Carrying Capacity and Friction Loss for Schedule 40 Thermoplastic Pipe
- Table 5 – Carrying Capacity and Friction Loss for Schedule 80 Thermoplastic Pipe
- Table 6 – Carrying Capacity and Friction Loss for DR 21 Thermoplastic Pipe
- Table 7 – Carrying Capacity and Friction Loss for DR 26 Thermoplastic Pipe
- Table 8 – Friction Loss through Fittings (Equivalent pipe length in feet)
- Table 9 – Temperature Correction Factors
- Table 10 – Coefficients of Thermal Expansion
- Table 11 – PVC Linear Expansion (ΔL) in inches
- Table 12 – CPVC Thermal Expansion (ΔL) in inches
- Table 13 – Working Stress at Elevated Temperatures (psi)
- Table 14 – Coefficients of Thermal Conductivity
- Table 15 – Modulus of Elasticity at Elevated Temperatures (E)
- Table 16 – Modulus of Soil Reaction (E')
- Table 17 – Manning Roughness Coefficient (n)
- Table 18 – Discharge Capacity for PVC Drainage Systems
- Table 19 – IPEX Thermoplastic PVC & CPVC Valves
- Table 20 – Cement Types
- Table 21 – Initial Set Schedule for IPEX and IPEX Recommended PVC/CPVC Solvent Cements
- Table 22 – Joint Cure Schedule for IPEX and IPEX Recommended PVC/CPVC Solvent Cements
- Table 23 – Average Number of Joints per quart of IPEX and IPEX Recommended Cement
- Table 24 – Average Number of Joints per US gallon of and IPEX Recommended IPEX Cement
- Table 25 – American National Standard Taper Pipe Threads (NPT)
- Table 26 – Maximum Pressures for Flanged Systems
- Table 27 – Recommended Torque
- Table 28 – Recommended Flange Bolt Sets
- Table 29 – Recommended Piping for Roll or Radius Cut Grooved Joints
- Table 30 – Grooved Joint Dimensions
- Table 31 – Maximum Pressures (psi) for Cut Grooved PVC Pipes at 73°F
- Table 32 – Temperature De-rating Factors for Grooved Joints
- Table 33 – Thrust at Fittings in lbs. Per 100 psi (internal pressure)
- Table 34 – Recommended Maximum Support Spacing in feet for Xirtec140 PVC
- Table 35 – Recommended Maximum Support Spacing in feet for Corzan CPVC
- Table 36 – Support Spacing Correction Factors
- Table 37 – Maximum Recommended Cover
- Table 38 – Dimensions for Xirtec140 PVC Well Casing Pipe
- Table 39 – PVC Duct Dimensions
- Figure 1 – Schematic of simple system loop

FIGURES

- Figure 2 – Schematic of simple system loop with valves
- Figure 3 – Pipe Configurations for Expansion/Contraction
- Figure 4 – Typical Expansion Loop
- Figure 5 – Expansion Joint
- Figure 6 – IPEX Telescopic Expansion Joint
- Figure 7 – Relative Humidity at which condensation will form on pipe walls
- Figure 8 – Critical Buckling Pressure Correction Factor “C” for buried pipe
- Figure 9 – Recommended Pipe Hangers for Thermoplastic Piping Systems

NOTES

NOTES

SALES AND CUSTOMER SERVICE

U.S. Customers call IPEX USA LLC

Toll free: (800) 463-9572

www.ipexamerica.com

About the IPEX Group of Companies

As leading suppliers of thermoplastic piping systems, the IPEX Group of Companies provides our customers with some of the largest and most comprehensive product lines. All IPEX products are backed by more than 50 years of experience. With state-of-the-art manufacturing facilities and distribution centers across North America, we have established a reputation for product innovation, quality, end-user focus and performance.

Markets served by IPEX group products are:

- Electrical systems
- Telecommunications and utility piping systems
- PVC, CPVC, PP, ABS, PEX, FR-PVDF and PE pipe and fittings (1/4" to 48")
- Industrial process piping systems
- Municipal pressure and gravity piping systems
- Plumbing and mechanical piping systems
- PE Electrofusion systems for gas and water
- Industrial, plumbing and electrical cements
- Irrigation systems

Products manufactured by IPEX Inc. and distributed in the United States by IPEX USA LLC.

Xirtec140® is a trademark of IPEX Branding Inc.

Corzan® is a registered trademark of the Lubrizol Corp.

This literature is published in good faith and is believed to be reliable. However it does not represent and/or warrant in any manner the information and suggestions contained in this brochure. Data presented is the result of laboratory tests and field experience.

A policy of ongoing product improvement is maintained. This may result in modifications of features and/or specifications without notice.

